

# OUTDOOR DESIGN

RANGE BOOK

02/021





Atlas Concorde is a global specialist in premium porcelain and wall tiles for every style and application in residential, commercial and public architecture. Being global specialists means excellence in the level of design and technology in each type of surface, making it possible to always offer designers and end users the best solution for each application.

Atlas Concorde è specialista globale in superfici ceramiche d'eccellenza per ogni stile e applicazione nell'architettura residenziale, commerciale e pubblica. Essere specialisti globali significa eccellere per livello di design e tecnologia in ciascun tipo di superficie, così da offrire sempre ai progettisti e agli utilizzatori finali la soluzione migliore per ogni applicazione.

**COLOURED BODY  
PORCELAIN TILES  
GRES PORCELLANATO  
COLORATO IN MASSA**  
Grès cérame coloré  
dans la masse  
Durchgefärbtes  
Feinsteinzeug  
Gres porcelánico  
coloreado en masa  
Керамический гранит  
окрашенный в массе

A photograph of a modern outdoor space featuring a swimming pool, a paved deck, and a white building with large glass windows. The sky is clear blue. A white rectangular box is overlaid on the right side of the image, containing text.

# OUTDOOR DESIGN

**RANGE BOOK**

**02 / 021**



# OUTDOOR RANGE

OUTDOOR PAVING ± 20 mm - 30 mm

STONELOOK

<b>Lims Ivory</b> Pag. 28	<b>Diesis Avorio</b> Pag. 52	<b>Sunrock Jerusalem Ivory</b> Pag. 42	<b>Norde Magnesio</b> Pag. 36	<b>Block Bianco</b> Pag. 48	<b>Trust Ivory</b> Pag. 44
<b>Sunrock Bourgogne Sand</b> Pag. 42	<b>Lims Desert</b> Pag. 28	<b>Norde Oro</b> Pag. 36	<b>Lims Grey</b> Pag. 28	<b>Norde Platino</b> Pag. 36	<b>Aix Cendre</b> Pag. 8
<b>Brave Gypsum</b> Pag. 12	<b>Kava Ivory</b> Pag. 56	<b>Dolmen Pro Cenere</b> Pag. 16	<b>Klif Silver</b> Pag. 20	<b>Brave Pearl</b> Pag. 12	<b>Kone Pearl</b> Pag. 24
<b>Block Grigio</b> Pag. 49	<b>Brave Earth</b> Pag. 12	<b>Kone Grey</b> Pag. 24	<b>Brave Grey</b> Pag. 12	<b>Seastone Gray</b> Pag. 40	<b>Trust Titanium</b> ± 20 mm ± 30 mm Pag. 44

CONCRETELOOK

<b>Raw White</b> Pag. 76	<b>Dwell Off White</b> Pag. 70	<b>Flux Bone</b> Pag. 80	<b>Dwell Pearl</b> Pag. 52	<b>Raw Pearl</b> Pag. 76	<b>Boost White</b> Pag. 62
<b>Boost Grey</b> Pag. 62	<b>Boost Pro Taupe</b> Pag. 66	<b>Boost Smoke</b> Pag. 62	<b>Dwell Smoke</b> Pag. 70	<b>Boost Pro Tobacco</b> Pag. 66	<b>Boost Tarmac</b> Pag. 62

WOODLOOK

<b>Axi White Pine</b> Pag. 86	<b>Axi Golden Oak</b> Pag. 86	<b>Exence Almond</b> Pag. 94	<b>Etic Pro Rovere Venice</b> Pag. 90	<b>Exence Amber</b> Pag. 94	<b>Axi Brown Chestnut</b> Pag. 86
----------------------------------	----------------------------------	---------------------------------	--	--------------------------------	--------------------------------------

<b>Aix Blanc</b> Pag. 8	<b>Sunrock Rapolano Beige</b> Pag. 42	<b>Lims Beige</b> Pag. 28	<b>Diesis Beige</b> Pag. 52	<b>Aix Beige</b> Pag. 8	<b>Trust Gold</b> ± 20 mm ± 30 mm Pag. 44
<b>Seastone Greige</b> Pag. 40	<b>Norde Piombo</b> Pag. 36	<b>Diesis Greige</b> Pag. 52	<b>Dolmen Pro Mix</b> Pag. 16	<b>Block Beige</b> Pag. 48	<b>Dolmen Pro Rosso</b> Pag. 16
<b>Trust Silver</b> ± 20 mm ± 30 mm Pag. 44	<b>Kava Silver</b> Pag. 56	<b>Klif Grey</b> Pag. 20	<b>Dolmen Pro Grigio</b> Pag. 16	<b>Kava Grey</b> Pag. 56	<b>Marvel Stone Cardoso Elegant</b> Pag. 30
<b>Marvel Stone Basaltina Volcano</b> Pag. 30	<b>Aix Fumée</b> Pag. 8	<b>Brave Coke</b> Pag. 12	<b>Seastone Black</b> Pag. 40	<b>Klif Dark</b> Pag. 20	
<b>Boost Pro Cream</b> Pag. 66	<b>Raw Sand</b> Pag. 76	<b>Boost Pro Clay</b> Pag. 66	<b>Flux Concrete</b> Pag. 80	<b>Raw Mud</b> Pag. 76	<b>Dwell Gray</b> Pag. 70
<b>Flux Coke</b> Pag. 80	<b>RESINLOOK</b>	<b>Prism Cord</b> Pag. 72	<b>Prism Cloud</b> Pag. 72	<b>Prism Fog</b> Pag. 72	<b>Prism Suede</b> Pag. 72
<b>Etic Pro Noce Hickory</b> Pag. 90		<b>Axi Grey Timber</b> Pag. 86	<b>METALLOOK</b>	<b>Blaze Corten</b> Pag. 100	

# OUTDOOR RANGE

TEXTURED / GRIP  $\pm 9$  mm - 9,5 mm

STONELOOK

<b>Kone White</b> Pag. 26	<b>Lims Ivory</b> Pag. 30	<b>Klif White</b> Pag. 24	<b>Brave Gypsum</b> Pag. 12	<b>Trust Moon</b> Pag. 46	<b>Norde Magnesio</b> Pag. 38
<b>Norde Oro</b> Pag. 38	<b>Lims Grey</b> Pag. 30	<b>Diesis Beige</b> $\pm 8$ mm Pag. 54	<b>Aix Beige</b> Pag. 10	<b>Diesis Greige</b> $\pm 8$ mm Pag. 54	<b>Trust Gold</b> Pag. 46
<b>Block Beige</b> $\pm 8$ mm $\pm 8,6$ mm Pag. 50	<b>Dolmen Pro Rosso</b> Pag. 18	<b>Trust Copper</b> Pag. 46	<b>Kone Silver</b> Pag. 26	<b>Marvel Stone Clauzetto White</b> Pag. 34	<b>Kava Ivory</b> $\pm 8$ mm $\pm 9$ mm Pag. 58
<b>Klif Grey</b> Pag. 22	<b>Dolmen Pro Grigio</b> Pag. 18	<b>Kava Grey</b> $\pm 8$ mm $\pm 9$ mm Pag. 58	<b>Marvel Stone Cardoso Elegant</b> Pag. 34	<b>Block Grigio</b> $\pm 8$ mm $\pm 8,6$ mm Pag. 50	<b>Brave Earth</b> Pag. 12

CONCRETELOOK

<b>Brave Coke</b> Pag. 12	<b>Klif Dark</b> Pag. 22	<b>Boost Pro Ivory</b> Pag. 68	<b>Arkshade White</b> Pag. 60	<b>Raw White</b> Pag. 78
<b>Flux Sand</b> $\pm 8$ mm Pag. 82	<b>Arkshade Dove</b> Pag. 60	<b>Flux Concrete</b> $\pm 8$ mm Pag. 82	<b>Boost Pro Clay</b> Pag. 68	<b>Raw Mud</b> Pag. 78
<b>Boost Tarmac</b> Pag. 64	<b>Flux Coke</b> $\pm 8$ mm Pag. 82	<b>Prism Cord</b> Pag. 74	<b>Prism Cloud</b> Pag. 74	<b>Prism Fog</b> Pag. 74

RESINLOOK

<b>Exence Almond</b> Pag. 96	<b>Arbor Natural</b> Pag. 84	<b>Etic Pro Rovere Venice</b> Pag. 92	<b>Exence Amber</b> Pag. 96	<b>Axi Brown Chestnut</b> $\pm 9,5$ mm Pag. 88	<b>Arbor Cognac</b> Pag. 84
<b>Nash Greige</b> Pag. 98	<b>Arbor Grey</b> Pag. 84	<b>Nash Gray Wood</b> Pag. 98	<b>Axi Grey Timber</b> $\pm 9,5$ mm Pag. 88	<b>Nash Dark Oak</b> Pag. 98	

MARBLELOOK

<b>Marvel Pro Crema Delicato</b> Pag. 102	<b>Marvel Pro Statuario Select</b> Pag. 102	<b>Marvel Pro Grey Fleury</b> Pag. 102
--	--	---

<b>Block Bianco</b> $\pm 8$ mm $\pm 8,6$ mm Pag. 50	<b>Trust Ivory</b> Pag. 46	<b>Diesis Avorio</b> $\pm 8$ mm Pag. 54	<b>Aix Blanc</b> Pag. 10	<b>Kone Beige</b> Pag. 26	<b>Lims Beige</b> Pag. 30
<b>Lims Desert</b> Pag. 30	<b>Marvel Stone Desert Beige</b> Pag. 34	<b>Norde Platino</b> Pag. 38	<b>Aix Cendre</b> Pag. 10	<b>Norde Piombo</b> Pag. 38	<b>Dolmen Pro Mix</b> Pag. 18
<b>Dolmen Pro Cenere</b> Pag. 18	<b>Klif Silver</b> Pag. 22	<b>Brave Pearl</b> Pag. 12	<b>Kone Pearl</b> Pag. 26	<b>Trust Silver</b> Pag. 46	<b>Kava Silver</b> $\pm 8$ mm $\pm 9$ mm Pag. 58
<b>Kone Grey</b> Pag. 26	<b>Brave Grey</b> Pag. 12	<b>Trust Titanium</b> Pag. 46	<b>Marvel Stone Basaltina Volcano</b> Pag. 34	<b>Block Fumo</b> $\pm 8$ mm $\pm 8,6$ mm Pag. 50	<b>Aix Fumée</b> Pag. 10

<b>Flux Bone</b> $\pm 8$ mm Pag. 82	<b>Arkshade Clay</b> Pag. 60	<b>Raw Pearl</b> Pag. 78	<b>Boost White</b> Pag. 64	<b>Boost Pro Cream</b> Pag. 68	<b>Raw Sand</b> Pag. 78
<b>Boost Pearl</b> Pag. 64	<b>Boost Grey</b> Pag. 64	<b>Boost Pro Taupe</b> Pag. 68	<b>Arkshade Lead</b> Pag. 60	<b>Boost Smoke</b> Pag. 64	<b>Boost Pro Tobacco</b> Pag. 68

WOODLOOK

<b>Prism Suede</b> Pag. 74	<b>Axi White Pine</b> $\pm 9,5$ mm Pag. 88	<b>Arbor Almond</b> Pag. 84	<b>Exence Vanilla</b> Pag. 96	<b>Axi Golden Oak</b> $\pm 9,5$ mm Pag. 88
<b>Etic Pro Noce Hickory</b> Pag. 92	<b>Axi Dark Oak</b> $\pm 9,5$ mm Pag. 88	<b>Arbor Tobacco</b> Pag. 84	<b>Nash Light Brown</b> Pag. 98	<b>Nash White Wood</b> Pag. 98
	<b>Axi Silver Fir</b> $\pm 9,5$ mm Pag. 88			

METALLOOK

<b>Blaze Aluminium</b> Pag. 100	<b>Blaze Iron</b> Pag. 100	<b>Blaze Corten</b> Pag. 100
------------------------------------	-------------------------------	---------------------------------

# AIX

COLOURED BODY PORCELAIN TILES / GRES PORCELLANATO COLORATO IN MASSA

Grès cérame coloré dans la masse . Durchgefärbtes Feinsteinzeug . Gres porcelánico coloreado en masa . Керамический гранит окрашенный в массе



R11  
A+B+C



H  
HEAVY  
TRAFFIC



V3  
MODERATE  
VARIATION

## OUTDOOR PAVING / PAVIMENTI DA ESTERNO

Sols d'extérieur . Bodenbeläge für Außenbereiche . Pavimentos para exteriores . Уличная плитка

20 mm

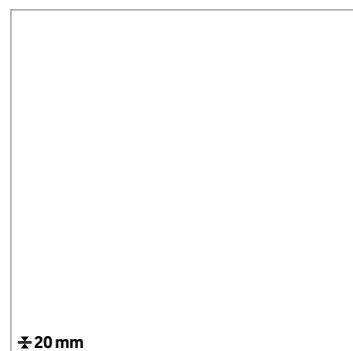

120x120 cm



60x90 cm

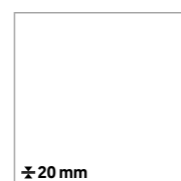

60x60 cm

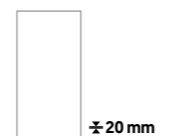

22,5x45,4 cm



22,5x22,5 cm

Rectified monocaliber . Rettificato monocalibro . Rectifié monocalibre . Rektifiziert Monokalibriert . Rectificado monocalibre . Одном калибре

**120x120 cm** 47<sup>1</sup>/<sub>8</sub>"x47<sup>1</sup>/<sub>8</sub>" 20 mm Blanc / Beige / Cendre / Fumée

**60x90 cm** 23<sup>5</sup>/<sub>8</sub>"x35<sup>5</sup>/<sub>8</sub>" 20 mm Blanc / Beige / Cendre / Fumée

**60x60 cm** 23<sup>5</sup>/<sub>8</sub>"x23<sup>5</sup>/<sub>8</sub>" 20 mm Beige / Cendre

Not rectified . Non rettificato . Non rectifié . Nicht Rektifiziert . No Rectificado . Неретифицированные

**22,5x45,4 cm** 8<sup>7</sup>/<sub>8</sub>"x17<sup>3</sup>/<sub>4</sub>" 20 mm Beige / Cendre

**22,5x22,5 cm** 8<sup>7</sup>/<sub>8</sub>"x8<sup>7</sup>/<sub>8</sub>" 20 mm Beige / Cendre



Blanc



Beige



Cendre



Fumée

# AIX

COLOURED BODY PORCELAIN TILES / GRES PORCELLANATO COLORATO IN MASSA

Grès cérame coloré dans la masse . Durchgefärbtes Feinsteinzeug . Gres porcelánico coloreado en masa . Керамический гранит окрашенный в массе

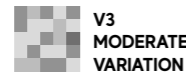

## GRIP SURFACE / SUPERFICIE GRIP

Surface grip . Grip oberfläche . Superficie Grip . Grip поверхность

9 mm

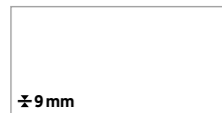

37,5x75 cm

Rectified monocaliber . Rettificato monocalibro . Rectifié monocalibre . Rektifiziert Monokalibriert . Rectificado monocalibre . Одном калибре

37,5x75 cm 14<sup>3</sup>/<sub>4</sub>"x29<sup>1</sup>/<sub>2</sub>" 9 mm Blanc / Beige / Cendre / Fumée

## TEXTURED SURFACE / SUPERFICIE STRUTTURATA

Surface structuré . Strukturiert oberfläche . Superficie estructurado . Структурная поверхность

9 mm



22,5x45,4 cm 22,5x22,5 cm

Not rectified monocaliber . Non rettificato monocalibro . Non rectifié monocalibre . Nicht Rektifiziert Monokalibriert . No Rectificado monocalibre . Неретифицированные

22,5x45,4 cm 8<sup>7</sup>/<sub>8</sub>"x17<sup>3</sup>/<sub>4</sub>" 9 mm Beige / Cendre

22,5x22,5 cm 8<sup>7</sup>/<sub>8</sub>"x8<sup>7</sup>/<sub>8</sub>" 9 mm Beige / Cendre

## DECORS



Aix Brick Tumbled 37x37 cm 14<sup>5</sup>/<sub>8</sub>"x14<sup>5</sup>/<sub>8</sub>"  
Blanc / Beige / Cendre / Fumée

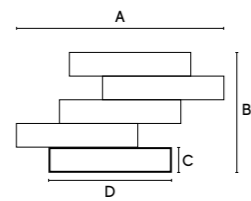

A: 62,7 cm - 24<sup>3</sup>/<sub>8</sub>"  
B: 36,7 cm - 14<sup>3</sup>/<sub>8</sub>"  
C: 7,15 cm - 2<sup>7</sup>/<sub>16</sub>"  
D: 36,65 cm - 14<sup>3</sup>/<sub>8</sub>"



Blanc



Beige



Cendre



Fumée

# BRAVE

COLOURED BODY PORCELAIN TILES / GRES PORCELLANATO COLORATO IN MASSA

Grès cérame coloré dans la masse . Durchgefärbtes Feinsteinzeug . Gres porcelánico coloreado en masa . Керамический гранит окрашенный в массе



V2  
SLIGHT  
VARIATION

## OUTDOOR PAVING / PAVIMENTI DA ESTERNO

Sols d'extérieur . Bodenbeläge für Außenbereiche . Pavimentos para exteriores . Уличная плитка

20 mm

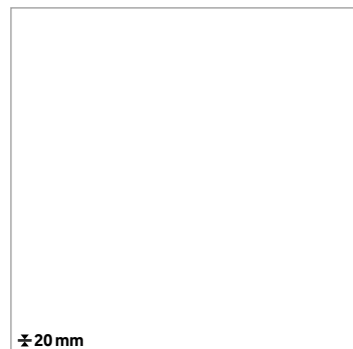

120x120 cm

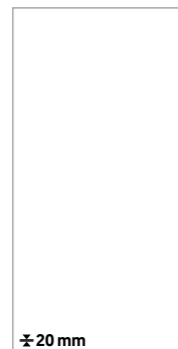

60x120 cm



45x90 cm

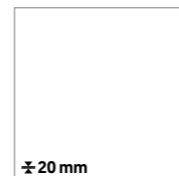

60x60 cm



30x60 cm

Rectified monocaliber . Rettificato monocalibro . Rectifié monocalibre . Rektifiziert Monokalibriert . Rectificado monocalibre . Одном калибре

**120x120 cm** 47<sup>1</sup>/<sub>4</sub>"x47<sup>1</sup>/<sub>4</sub>" 20 mm Grey / Coke

**60x120 cm** 23<sup>5</sup>/<sub>8</sub>"x47<sup>1</sup>/<sub>4</sub>" 20 mm Gypsum / Pearl / Grey / Earth / Coke

**45x90 cm** 17<sup>3</sup>/<sub>4</sub>"x35<sup>3</sup>/<sub>8</sub>" 20 mm Gypsum / Pearl / Grey / Earth / Coke

**60x60 cm** 23<sup>5</sup>/<sub>8</sub>"x23<sup>5</sup>/<sub>8</sub>" 20 mm Gypsum / Pearl / Grey / Earth / Coke

**30x60 cm** 11<sup>3</sup>/<sub>4</sub>"x23<sup>5</sup>/<sub>8</sub>" 20 mm Gypsum / Pearl / Grey / Earth / Coke



Gypsum



Pearl



Grey



Earth



Coke



# BRAVE

COLOURED BODY PORCELAIN TILES / GRES PORCELLANATO COLORATO IN MASSA

Grès cérame coloré dans la masse . Durchgefärbtes Feinsteinzeug . Gres porcelánico coloreado en masa . Керамический гранит окрашенный в массе



R12  
A+B+C



HEAVY  
TRAFFIC



V2  
SLIGHT  
VARIATION

## GRIP SURFACE / SUPERFICIE GRIP

Surface grip . Grip oberfläche . Superficie Grip . Grip поверхность

9 mm



± 9 mm

30x60 cm

Rectified monocaliber . Rettificato monocalibro . Rectifié monocalibre . Rektifiziert Monokalibriert . Rectificado monocalibre . Одном калибре

30x60 cm 11<sup>3</sup>/<sub>4</sub>"x23<sup>5</sup>/<sub>8</sub>" ± 9 mm Gypsum / Pearl / Grey / Earth / Coke

## DECORS



Brave Listello 8x60 cm 3<sup>1</sup>/<sub>8</sub>"x23<sup>5</sup>/<sub>8</sub>"

Gypsum / Pearl / Grey / Earth / Coke



Gypsum



Pearl



Grey



Earth



Coke

# DOLMEN PRO

COLOURED BODY PORCELAIN TILES / GRES PORCELLANATO COLORATO IN MASSA

Grès cérame coloré dans la masse . Durchgefärbtes Feinsteinzeug . Gres porcelánico coloreado en masa . Керамический гранит окрашенный в массе



V2  
SLIGHT  
VARIATION



V4  
SUBSTANTIAL  
VARIATION

Cenere / Rosso / Grigio

Mix

## OUTDOOR PAVING / PAVIMENTI DA ESTERNO

Sols d'extérieur . Bodenbeläge für Außenbereiche . Pavimentos para exteriores . Уличная плитка

20 mm

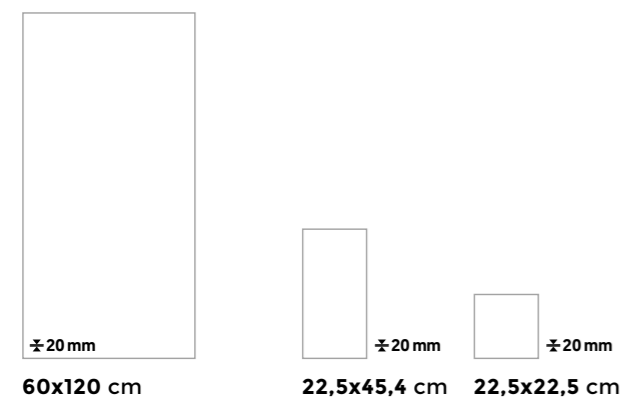

Rectified monocaliber . Rettificato monocalibro . Rectifié monocalibre . Rektifiziert Monokalibriert . Rectificado monocalibre . Одном калибре

**60x120 cm** 23<sup>5</sup>/<sub>8</sub>"x47<sup>1</sup>/<sub>4</sub>" ± 20 mm Cenere / Grigio / Rosso

Not rectified . Non rettificato . Non rectifié . Nicht Rektifiziert . No Rectificado . Неретифицированные

**22,5x45,4 cm** 8<sup>7</sup>/<sub>8</sub>"x17<sup>3</sup>/<sub>4</sub>" ± 20 mm Rosso / Mix

**22,5x22,5 cm** 8<sup>7</sup>/<sub>8</sub>"x8<sup>7</sup>/<sub>8</sub>" ± 20 mm Rosso / Mix



Cenere

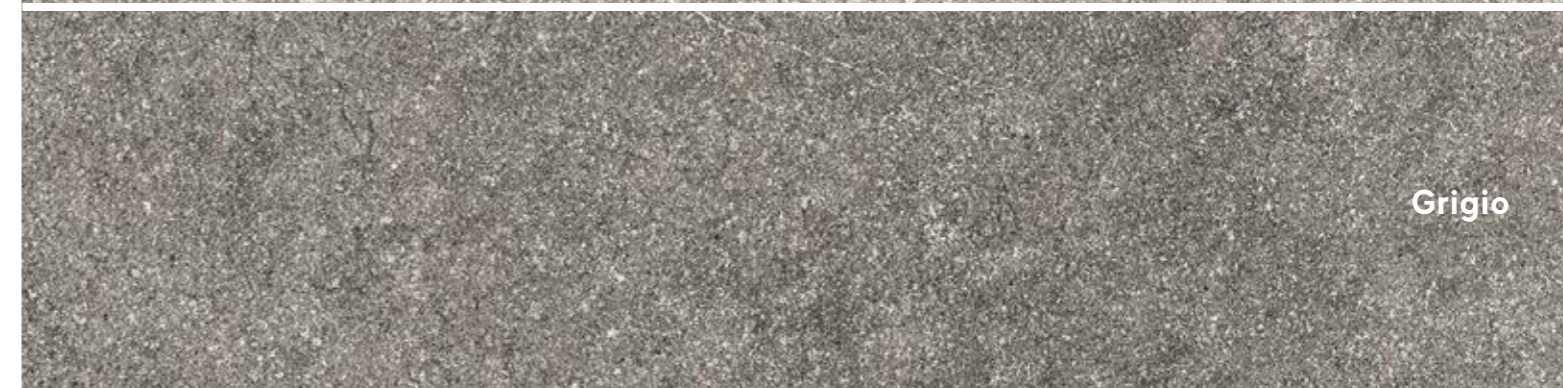

Grigio



Rosso



Mix

# DOLMEN PRO

COLOURED BODY PORCELAIN TILES / GRES PORCELLANATO COLORATO IN MASSA

Grès cérame coloré dans la masse . Durchgefärbtes Feinsteinzeug . Gres porcelánico coloreado en masa . Керамический гранит окрашенный в массе



R11  
A+B+C



HEAVY  
TRAFFIC



V2  
SLIGHT  
VARIATION

Cenere / Rosso / Grigio



V4  
SUBSTANTIAL  
VARIATION

Mix

## GRIP SURFACE / SUPERFICIE GRIP

Surface grip . Grip oberfläche . Superficie Grip . Grip поверхность

9 mm

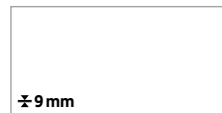

± 9 mm

37,5x75 cm

Rectified monocaliber . Rettificato monocalibro . Rectifié monocalibre . Rektifiziert Monokalibriert . Rectificado monocalibre . Одном калибре

37,5x75 cm 14<sup>3</sup>/<sub>4</sub>"x29<sup>1</sup>/<sub>2</sub>" ± 9 mm Cenere / Grigio / Rosso / Mix

## TEXTURED SURFACE / SUPERFICIE STRUTTURATA

Surface structuré . Strukturiert oberfläche . Superficie estructurado . Структурная поверхность

9 mm



± 9 mm



± 9 mm

22,5x45,3 cm 22,5x22,5 cm

Not rectified monocaliber . Non rettificato monocalibro . Non rectifié monocalibre . Nicht Rektifiziert Monokalibriert . No Rectificado monocalibre . Неретифицированные

22,5x45,3 cm 8<sup>7</sup>/<sub>8</sub>"x17<sup>3</sup>/<sub>4</sub>" ± 9 mm Cenere / Grigio / Rosso / Mix

22,5x22,5 cm 8<sup>7</sup>/<sub>8</sub>"x8<sup>7</sup>/<sub>8</sub>" ± 9 mm Cenere / Grigio / Rosso / Mix

## DECORS

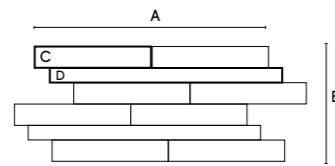

A: 74,8 cm - 29<sup>1</sup>/<sub>2</sub>"  
B: 37,4 cm - 14<sup>3</sup>/<sub>4</sub>"  
C: 7x37,3 cm - 2<sup>3</sup>/<sub>4</sub>"x14<sup>3</sup>/<sub>4</sub>"  
D: 4,2x74,8 cm - 1<sup>1</sup>/<sub>8</sub>"x29<sup>1</sup>/<sub>2</sub>"



Dolmen Pro Brick 37,5x75 cm 14<sup>3</sup>/<sub>4</sub>"x29<sup>1</sup>/<sub>2</sub>"

Cenere / Grigio / Rosso / Mix

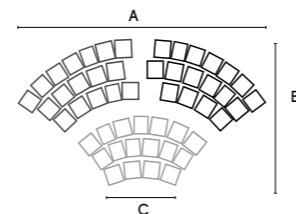

A: 102,8 cm - 40<sup>1</sup>/<sub>2</sub>"  
B: 53,2 cm - 20<sup>7</sup>/<sub>8</sub>"  
C: 30,5 cm - 12"

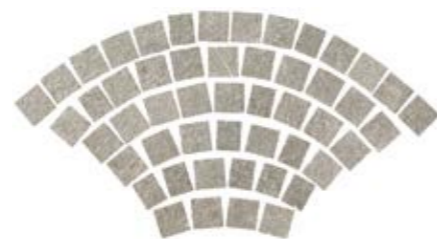

Dolmen Pro Coda di Pavone\* 53,2x102,8 cm 20<sup>3</sup>/<sub>4</sub>"x29<sup>1</sup>/<sub>2</sub>"

Cenere / Grigio / Rosso / Mix / Cenere-Rosso

\* Tumbled / Burattato / Tamisé / Genarbt / Tamboreado / Выщербленный



Cenere



Grigio



Rosso



Mix

# KLIF

COLOURED BODY PORCELAIN TILES / GRES PORCELLANATO COLORATO IN MASSA

Grès cérame coloré dans la masse . Durchgefärbtes Feinsteinzeug . Gres porcelánico coloreado en masa . Керамический гранит окрашенный в массе



V2  
SLIGHT  
VARIATION

## OUTDOOR PAVING / PAVIMENTI DA ESTERNO

Sols d'extérieur . Bodenbeläge für Außenbereiche . Pavimentos para exteriores . Уличная плитка

 20 mm

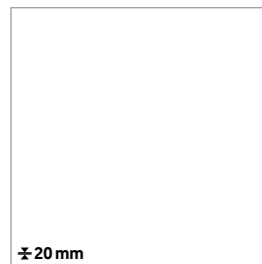

$\pm 20$  mm

90x90 cm



$\pm 20$  mm

45x90 cm



$\pm 20$  mm

60x60 cm

Rectified monocaliber . Rettificato monocalibro . Rectifié monocalibre . Rektifiziert Monokalibriert . Rectificado monocalibre . Одном калибре

**90x90 cm**  $35\frac{3}{8}'' \times 35\frac{3}{8}''$   $\pm 20$  mm Silver / Grey / Dark

**45x90 cm**  $17\frac{3}{4}'' \times 35\frac{3}{8}''$   $\pm 20$  mm Silver / Grey / Dark

**60x60 cm**  $23\frac{5}{8}'' \times 23\frac{5}{8}''$   $\pm 20$  mm Silver / Grey / Dark



Silver



Grey



Dark

# KLIF

COLOURED BODY PORCELAIN TILES / GRES PORCELLANATO COLORATO IN MASSA

Grès cérame coloré dans la masse . Durchgefärbtes Feinsteinzeug . Gres porcelánico coloreado en masa . Керамический гранит окрашенный в массе



## GRIP SURFACE / SUPERFICIE GRIP

Surface grip . Grip oberfläche . Superficie Grip . Grip поверхность

9 mm



37,5x75 cm

Rectified monocaliber . Rettificato monocalibro . Rectifié monocalibre . Rektifiziert Monokalibriert . Rectificado monocalibre . Одном калибре

**37,5x75 cm** 14<sup>3</sup>/<sub>4</sub>"x29<sup>1</sup>/<sub>2</sub>"  $\pm$  9 mm White / Silver / Grey / Dark

## DECORS

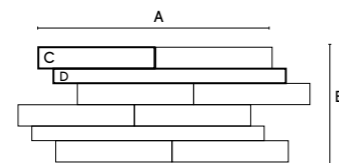

A: 74,8 cm - 29<sup>1</sup>/<sub>2</sub>"  
 B: 37,4 cm - 14<sup>3</sup>/<sub>4</sub>"  
 C: 7x37,3 cm - 2<sup>3</sup>/<sub>4</sub>"x14<sup>3</sup>/<sub>4</sub>"  
 D: 4,2x74,8 cm - 1<sup>1</sup>/<sub>2</sub>"x29<sup>1</sup>/<sub>2</sub>"

**Klif Brick 37,5x75 cm** 14<sup>3</sup>/<sub>4</sub>"x29<sup>1</sup>/<sub>2</sub>"  
 White / Silver / Grey / Dark



White



Silver

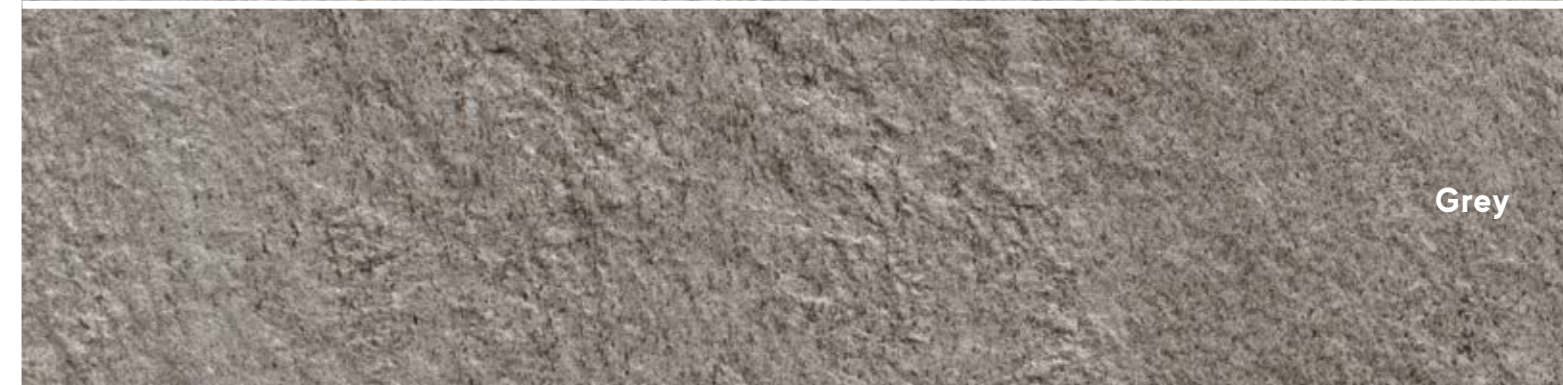

Grey



Dark

# KONE

COLOURED BODY PORCELAIN TILES / GRES PORCELLANATO COLORATO IN MASSA

Grès cérame coloré dans la masse . Durchgefärbtes Feinsteinzeug . Gres porcelánico coloreado en masa . Керамический гранит окрашенный в массе



## OUTDOOR PAVING / PAVIMENTI DA ESTERNO

Sols d'extérieur . Bodenbeläge für Außenbereiche . Pavimentos para exteriores . Уличная плитка

20 mm



Pearl



Grey

STONE LOOK



± 20 mm

60x60 cm

Rectified monocaliber . Rettificato monocalibro . Rectifié monocalibre . Rektifiziert Monokalibriert . Rectificado monocalibre . Одном калибре

60x60 cm 23<sup>5</sup>/<sub>8</sub>"x23<sup>5</sup>/<sub>8</sub>" ± 20 mm Pearl / Grey

# KONE

COLOURED BODY PORCELAIN TILES / GRES PORCELLANATO COLORATO IN MASSA

Grès cérame coloré dans la masse . Durchgefärbtes Feinsteinzeug . Gres porcelánico coloreado en masa . Керамический гранит окрашенный в массе



## GRIP SURFACE / SUPERFICIE GRIP

Surface grip . Grip oberfläche . Superficie Grip . Grip поверхность

9 mm



30x60 cm

Rectified monocaliber . Rettificato monocalibro . Rectifié monocalibre . Rektifiziert Monokalibriert . Rectificado monocalibre . Одном калибре

30x60 cm 11<sup>3</sup>/<sub>4</sub>"x23<sup>5</sup>/<sub>8</sub>" 9 mm Beige / Pearl / Silver / Grey

## DECORS



**Kone Brick 30x60 cm** 11<sup>3</sup>/<sub>4</sub>"x23<sup>5</sup>/<sub>8</sub>"  
White / Beige / Pearl / Silver / Grey

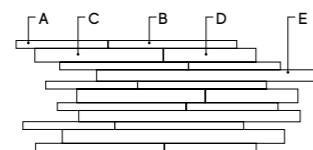

A: 2,1x24,8 cm - 3<sup>1</sup>/<sub>4</sub>"x9<sup>1</sup>/<sub>4</sub>"  
B: 2,1x34,5 cm - 3<sup>1</sup>/<sub>4</sub>"x13<sup>5</sup>/<sub>8</sub>"  
C: 3,3x34,5 cm - 1<sup>1</sup>/<sub>4</sub>"x13<sup>5</sup>/<sub>8</sub>"  
D: 3,3x24,8 cm - 1<sup>1</sup>/<sub>4</sub>"x9<sup>1</sup>/<sub>4</sub>"  
E: 2,5x60 cm - 1"x23<sup>5</sup>/<sub>8</sub>"



**Industrial 3D 31,5x45 cm** 12<sup>3</sup>/<sub>8</sub>"x17<sup>3</sup>/<sub>4</sub>"  
Warm / Cold



**Kone Listello 8x60 cm** 3<sup>1</sup>/<sub>8</sub>"x23<sup>5</sup>/<sub>8</sub>"  
White / Beige / Pearl / Silver / Grey



White



Beige



Pearl



Silver



Grey

# LIMS

COLOURED BODY PORCELAIN TILES / GRES PORCELLANATO COLORATO IN MASSA

Grès cérame coloré dans la masse . Durchgefärbtes Feinsteinzeug . Gres porcelánico coloreado en masa . Керамический гранит окрашенный в массе



R11  
A+B+C

HEAVY  
TRAFFIC

V3  
MODERATE  
VARIATION

## OUTDOOR PAVING / PAVIMENTI DA ESTERNO

Sols d'extérieur . Bodenbeläge für Außenbereiche . Pavimentos para exteriores . Уличная плитка

20 mm



20 mm

60x120 cm

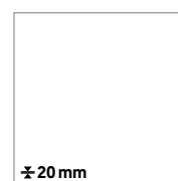

20 mm

60x60 cm

Rectified monocaliber . Rettificato monocalibro . Rectifié monocalibre . Rektifiziert Monokalibriert . Rectificado monocalibre . Одном калибре

**60x120 cm** 23<sup>5</sup>/<sub>8</sub>"x47<sup>1</sup>/<sub>4</sub>" 20 mm Ivory / Beige / Grey / Desert

**60x60 cm** 23<sup>5</sup>/<sub>8</sub>"x23<sup>5</sup>/<sub>8</sub>" 20 mm Ivory / Beige / Grey / Desert



Ivory



Beige



Grey

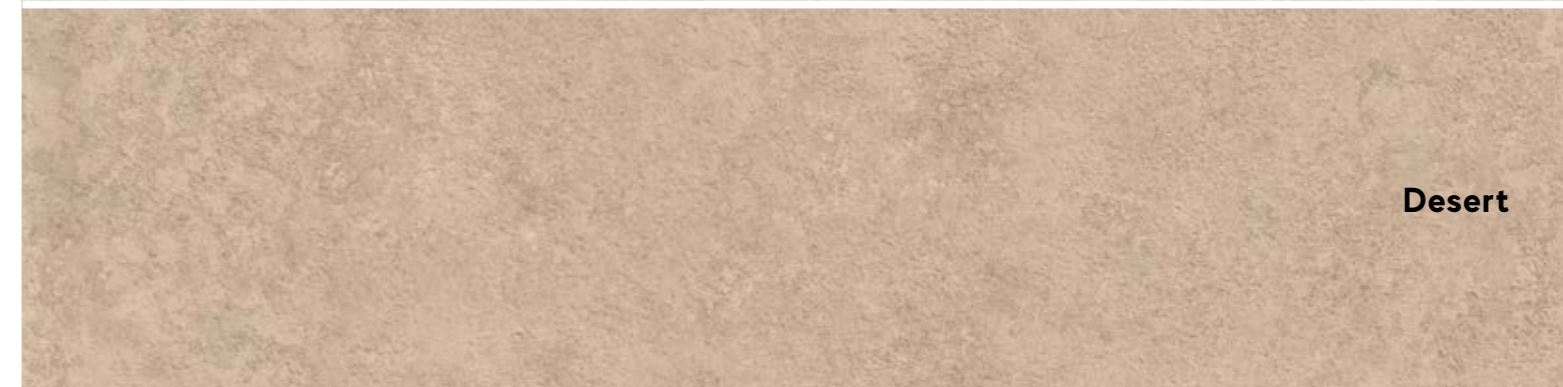

Desert



# LIMS

COLOURED BODY PORCELAIN TILES / GRES PORCELLANATO COLORATO IN MASSA

Grès cérame coloré dans la masse . Durchgefärbtes Feinsteinzeug . Gres porcelánico coloreado en masa . Керамический гранит окрашенный в массе

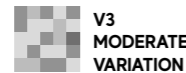

## GRIP SURFACE / SUPERFICIE GRIP

Surface grip . Grip oberfläche . Superficie Grip . Grip поверхность

9 mm



37,5x75 cm

Rectified monocaliber . Rettificato monocalibro . Rectifié monocalibre . Rektifiziert Monokalibriert . Rectificado monocalibre . Одном калибре

37,5x75 cm 14<sup>3</sup>/<sub>4</sub>"x29<sup>1</sup>/<sub>2</sub>" ± 9 mm Ivory / Beige / Grey / Desert

## DECORS



**Lims Brick 37,5x75 cm** 14<sup>3</sup>/<sub>4</sub>"x29<sup>1</sup>/<sub>2</sub>"  
Ivory / Beige / Grey / Desert

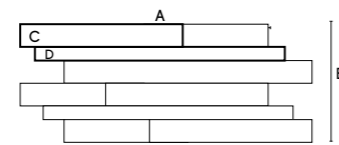

A: 75 cm - 29<sup>1</sup>/<sub>2</sub>"  
B: 37,5 cm - 14<sup>3</sup>/<sub>4</sub>"  
C: 6,9 x 49,1 cm - 2<sup>3</sup>/<sub>4</sub>"x19<sup>1</sup>/<sub>4</sub>"  
D: 4,4 x 75 cm - 1<sup>1</sup>/<sub>4</sub>"x29<sup>1</sup>/<sub>2</sub>"



**Lims Mosaico Spritz 29x32,3 cm** 12<sup>3</sup>/<sub>8</sub>"x17<sup>3</sup>/<sub>4</sub>"  
Ivory / Beige / Grey / Desert

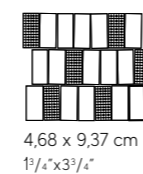

**Lims Mosaico Gemini 41,6x24 cm** 12<sup>1</sup>/<sub>4</sub>"x9<sup>1</sup>/<sub>2</sub>"  
Ivory / Beige / Grey / Desert

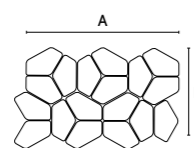

A: 41,6 cm - 12<sup>1</sup>/<sub>4</sub>"  
B: 24 cm - 9<sup>1</sup>/<sub>2</sub>"



**Lims Mosaico Tumbled 30x30 cm** 11<sup>3</sup>/<sub>4</sub>"x11<sup>3</sup>/<sub>4</sub>"  
Ivory / Beige / Grey / Desert

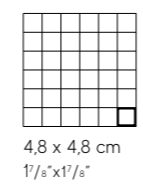

Ivory



Beige



Grey



Desert

# MARVEL STONE

COLOURED BODY PORCELAIN TILES / GRES PORCELLANATO COLORATO IN MASSA

Grès cérame coloré dans la masse . Durchgefärbtes Feinsteinzeug . Gres porcelánico coloreado en masa . Керамический гранит окрашенный в массе



V2  
SLIGHT  
VARIATION

## OUTDOOR PAVING / PAVIMENTI DA ESTERNO

Sols d'extérieur . Bodenbeläge für Außenbereiche . Pavimentos para exteriores . Уличная плитка

20 mm



± 20 mm

60x120 cm

Rectified monocaliber . Rettificato monocalibro . Rectifié monocalibre . Rektifiziert Monokalibriert . Rectificado monocalibre . Одном калибре

60x120 cm 23<sup>5</sup>/<sub>8</sub>"x47<sup>1</sup>/<sub>4</sub>" ± 20 mm Cardoso Elegant / Basaltina Volcano

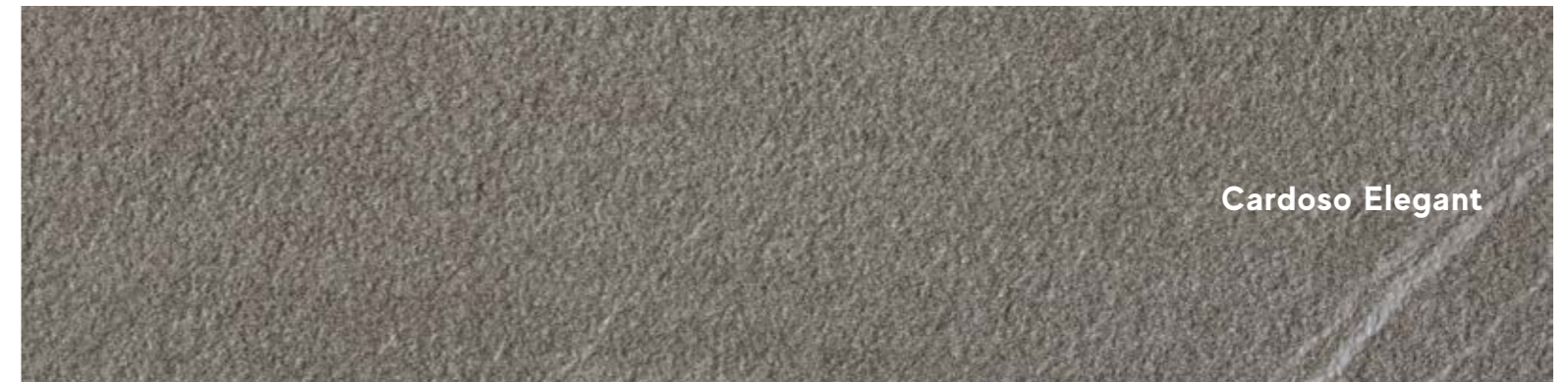

Cardoso Elegant



Basaltina Volcano

# MARVEL STONE

COLOURED BODY PORCELAIN TILES / GRES PORCELLANATO COLORATO IN MASSA

Grès cérame coloré dans la masse . Durchgefärbtes Feinsteinzeug . Gres porcelánico coloreado en masa . Керамический гранит окрашенный в массе



R11  
A+B+C

H  
HEAVY  
TRAFFIC

V2  
SLIGHT  
VARIATION

## TEXTURED SURFACE / SUPERFICIE STRUTTURATA

Surface structuré . Strukturiert oberfläche . Superficie estructurado . Структурная поверхность

9 mm



9 mm

30x60 cm

Rectified monocaliber . Rettificato monocalibro . Rectifié monocalibre . Rektifiziert Monokalibriert . Rectificado monocalibre . Одном калибре

30x60 cm  $11\frac{3}{4}'' \times 23\frac{5}{8}''$  9 mm Desert Beige / Clauzetto White / Cardoso Elegant / Basaltina Volcano

## DECORS



**Marvel Stone Brick 30x60 cm**  $11\frac{3}{4}'' \times 23\frac{5}{8}''$

Desert Beige / Clauzetto White  
Cardoso Elegant / Basaltina Volcano

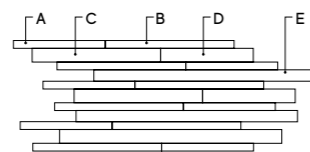

A: 2,1x24,8 cm -  $\frac{3}{4}'' \times 9\frac{3}{4}''$   
B: 2,1x34,5 cm -  $\frac{3}{4}'' \times 13\frac{5}{8}''$   
C: 3,3x34,5 cm -  $1\frac{3}{4}'' \times 13\frac{5}{8}''$   
D: 3,3x24,8 cm -  $1\frac{3}{4}'' \times 9\frac{3}{4}''$   
E: 2,5x60 cm -  $1'' \times 23\frac{5}{8}''$



**Marvel Stone Mosaico Bacchetta 30x30 cm**  $11\frac{3}{4}'' \times 11\frac{3}{4}''$

Desert Beige / Clauzetto White  
Cardoso Elegant / Basaltina Volcano

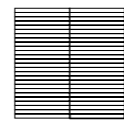

1x15 cm -  $\frac{3}{8}'' \times 5\frac{7}{8}''$



**Marvel Stone Listello 7x60 cm**  $2\frac{3}{4}'' \times 23\frac{5}{8}''$

Desert Beige / Clauzetto White / Cardoso Elegant / Basaltina Volcano



Desert Beige



Clauzetto White



Cardoso Elegant



Basaltina Volcano

# NORDE

COLOURED BODY PORCELAIN TILES / GRES PORCELLANATO COLORATO IN MASSA

Grès cérame coloré dans la masse . Durchgefärbtes Feinsteinzeug . Gres porcelánico coloreado en masa . Керамический гранит окрашенный в массе



R11  
A+B+C

HEAVY  
TRAFFIC

V3  
MODERATE  
VARIATION

## OUTDOOR PAVING / PAVIMENTI DA ESTERNO

Sols d'extérieur . Bodenbeläge für Außenbereiche . Pavimentos para exteriores . Уличная плитка

± 20 mm



60x120 cm



60x90 cm

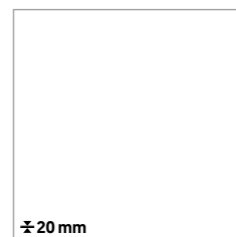

80x80 cm

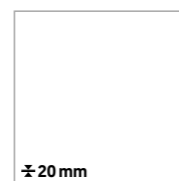

60x60 cm

Rectified monocaliber . Rettificato monocalibro . Rectifié monocalibre . Rektifiziert Monokalibriert . Rectificado monocalibre . Одном калибре

**60x120 cm** 23<sup>5</sup>/<sub>8</sub>"x47<sup>1</sup>/<sub>4</sub>" ± 20 mm Magnesio / Oro / Platino / Piombo

**60x90 cm** 23<sup>5</sup>/<sub>8</sub>"x35<sup>3</sup>/<sub>8</sub>" ± 20 mm Magnesio / Oro / Platino / Piombo

**80x80 cm** 31<sup>1</sup>/<sub>2</sub>"x31<sup>1</sup>/<sub>2</sub>" ± 20 mm Magnesio / Oro / Platino / Piombo

**60x60 cm** 23<sup>5</sup>/<sub>8</sub>"x23<sup>5</sup>/<sub>8</sub>" ± 20 mm Magnesio / Oro / Platino / Piombo

## DECORS



**Norde Path A+B** ± 20 mm  
**54x54 cm** 21<sup>1</sup>/<sub>4</sub>"x21<sup>1</sup>/<sub>4</sub>"

Magnesio / Oro / Platino / Piombo



**Norde Path C** ± 20 mm  
**55x109 cm** 21<sup>5</sup>/<sub>8</sub>"x42<sup>7</sup>/<sub>8</sub>"

Magnesio / Oro / Platino / Piombo

We recommend "dry" installation on gravel and/or grass . Si consiglia posa "a secco" su ghiaia e/o erba . Pose « à sec » sur gravillons et/ou herbe conseillée . Es wird eine Trockenverlegung auf Kies bzw. Rasen empfohlen . Se recomienda colocación «en seco» sobre grava o hierba . Рекомендуется «сухая» укладка на гравий и/или траву.



Magnesio



Oro



Platino



Piombo

# NORDE

COLOURED BODY PORCELAIN TILES / GRES PORCELLANATO COLORATO IN MASSA

Grès cérame coloré dans la masse . Durchgefärbtes Feinsteinzeug . Gres porcelánico coloreado en masa . Керамический гранит окрашенный в массе



## GRIP SURFACE / SUPERFICIE GRIP

Surface grip . Grip oberfläche . Superficie Grip . Grip поверхность

$\nabla$  9 mm



60x120 cm

Rectified monocaliber . Rettificato monocalibro . Rectifié monocalibre . Rektifiziert Monokalibriert . Rectificado monocalibre . Одном калибре

60x120 cm  $23\frac{5}{8} \times 47\frac{1}{4}$ "  $\nabla$  9 mm Magnesio / Oro / Platino / Piombo

## ROCCIA SURFACE / SUPERFICIE ROCCIA

Surface structuré . Strukturiert oberfläche . Superficie estructurado . Структурная поверхность

$\nabla$  9 mm



30x60 cm

Not rectified monocaliber . Non rettificato monocalibro . Non rectifié monocalibre . Nicht Rektifiziert Monokalibriert . No Rectificado monocalibre . Неретифицированные

30x60 cm  $11\frac{3}{4} \times 23\frac{5}{8}$ "  $\nabla$  9 mm Magnesio / Oro / Platino / Piombo

## DECORS



Norde Composizione Palladiana Grip \*

Magnesio / Oro / Platino / Piombo



Norde Brick 30x60 cm  $11\frac{3}{4} \times 23\frac{5}{8}$ "

Magnesio / Oro / Platino / Piombo



Norde Brick Corten \*\* 27,8x39 cm  $11 \times 15\frac{3}{8}$ "

Magnesio / Oro / Platino / Piombo

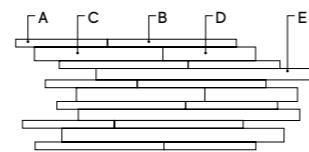

A: 2,1x24,8 cm -  $\frac{3}{4} \times 9\frac{7}{8}$ "  
 B: 2,1x34,5 cm -  $\frac{3}{4} \times 13\frac{5}{8}$ "  
 C: 3,3x34,5 cm -  $1\frac{1}{4} \times 13\frac{5}{8}$ "  
 D: 3,3x24,8 cm -  $1\frac{1}{4} \times 9\frac{7}{8}$ "  
 E: 2,5x60 cm -  $1 \times 23\frac{5}{8}$ "

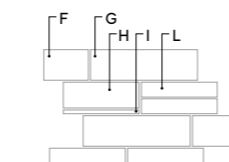

F: 7,82x11,42 cm -  $3\frac{1}{8} \times 4\frac{1}{2}$ "  
 G: 7,82x27,42 cm -  $3\frac{1}{8} \times 10\frac{7}{8}$ "  
 H: 1,0x19,42 cm -  $\frac{3}{8} \times 7\frac{5}{8}$ "  
 I: 6,64x19,42 cm -  $2\frac{5}{8} \times 7\frac{5}{8}$ "  
 L: 3,82x19,42 cm -  $1\frac{5}{8} \times 7\frac{5}{8}$ "



Magnesio



Oro



Platino



Piombo

\* Example of layout measuring about 1 m<sup>2</sup>. Minimum order: 8 m<sup>2</sup>. Variable tessera size and shape with tumbled edge. We recommend installation with a joint of no less than 10 mm . Esempio di posato corrispondente a circa 1 mq. Ordine minimo di 8 mq. Dimensione e forma delle tessere variabile con bordo burattato. Si consiglia posa con fuga non inferiore a 10mm . Exemple de produit posé correspondant à 1 mètre carré environ. Commande minimum: 8 mètres carrés. Dimensions et forme des tesselles variables avec bord tamisé. Pose conseillée avec un joint non inférieur à 10mm . Verlegebeispiel für circa 1 qm. Mindestbestellmenge 8 qm. Abmessung und Form der Steine sind unterschiedlich, aber alle weisen getrommelte Kanten auf. Für die Verlegung wird eine Fugenbreite von nicht weniger als 10 mm empfohlen . Ejemplo de colocación correspondiente aproximadamente a 1 m. Pedido mínimo de 8 m. Tamaño y forma variable de los mosaicos con borde bruñido. Se recomienda colocación con junta de no menos de 10 mm . Пример укладки, соответствующий примерно 1 кв.м. Минимальный объем заказа – 8 кв.м. Размер и форма чипса варьируются, чипсы имеют выщербленные края. Рекомендуется укладка с межплиточным швом не менее 10 мм.

\*\* Blaze Corten Lappato tessera inserted randomly in four of the six sheets contained in each box . Tessera Blaze Corten Lappato inserita in modo casuale in quattro dei sei fogli contenuti in ogni scatola . Tesselles Blaze Corten Lappato posées de manière aléatoire sur quatre des six feuilles contenues dans chaque boîte . Die Blaze Corten Lappato Steine werden nach dem Zufallsprinzip auf vier der sechs in jedem Karton enthaltenen Folien verklebt . Mosaico Blaze Corten Lappato insertado al azar en cuatro de las seis hojas que contiene cada caja . Чипса Blaze Corten Lappato включена случайным образом в четыре из шести матриц, содержащихся в каждой коробке.

# SEASTONE

COLOURED BODY PORCELAIN TILES / GRES PORCELLANATO COLORATO IN MASSA

Grès cérame coloré dans la masse . Durchgefärbtes Feinsteinzeug . Gres porcelánico coloreado en masa . Керамический гранит окрашенный в массе



V2  
SLIGHT  
VARIATION

## OUTDOOR PAVING / PAVIMENTI DA ESTERNO

Sols d'extérieur . Bodenbeläge für Außenbereiche . Pavimentos para exteriores . Уличная плитка

 20 mm

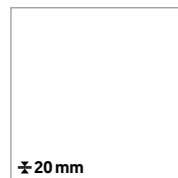

± 20 mm

60x60 cm

Rectified monocaliber . Rettificato monocalibro . Rectifié monocalibre . Rektifiziert Monokalibriert . Rectificado monocalibre . Одном калибре

60x60 cm 23<sup>5</sup>/<sub>8</sub>"x23<sup>5</sup>/<sub>8</sub>" ± 20 mm Greige / Gray / Black



Greige



Gray



Black

# SUNROCK

COLOURED BODY PORCELAIN TILES / GRES PORCELLANATO COLORATO IN MASSA

Grès cérame coloré dans la masse . Durchgefärbtes Feinsteinzeug . Gres porcelánico coloreado en masa . Керамический гранит окрашенный в массе



## OUTDOOR PAVING / PAVIMENTI DA ESTERNO

Sols d'extérieur . Bodenbeläge für Außenbereiche . Pavimentos para exteriores . Уличная плитка

20 mm

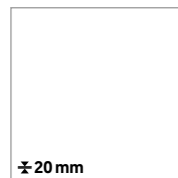

20 mm

60x60 cm

Rectified monocaliber . Rettificato monocalibro . Rectifié monocalibre . Rektifiziert Monokalibriert . Rectificado monocalibre . Одном калибре

60x60 cm 23<sup>5</sup>/<sub>8</sub>"x23<sup>5</sup>/<sub>8</sub>" 20 mm Jerusalem Ivory / Bourgogne Sand / Rapolano Beige



Jerusalem Ivory



Bourgogne Sand



Rapolano Beige

# TRUST

COLOURED BODY PORCELAIN TILES / GRES PORCELLANATO COLORATO IN MASSA

Grès cérame coloré dans la masse . Durchgefärbtes Feinsteinzeug . Gres porcelánico coloreado en masa . Керамический гранит окрашенный в массе



R11  
A+B+C



H  
HEAVY  
TRAFFIC



V3  
MODERATE  
VARIATION

## OUTDOOR PAVING / PAVIMENTI DA ESTERNO

Sols d'extérieur . Bodenbeläge für Außenbereiche . Pavimentos para exteriores . Уличная плитка

20 mm / 30 mm

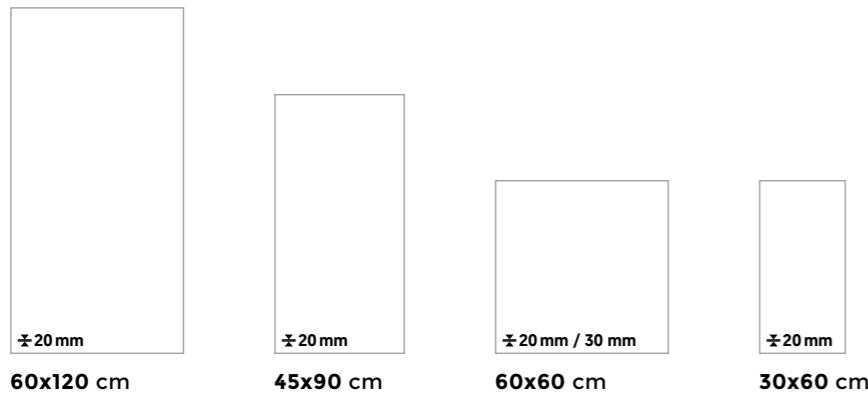

Rectified monocaliber . Rettificato monocalibro . Rectifié monocalibre . Rektifiziert Monokalibriert . Rectificado monocalibre . Одном калибре

**60x120 cm**  $23\frac{5}{8}'' \times 47\frac{1}{4}''$   $\nabla$  20 mm Ivory / Gold / Silver / Titanium

**45x90 cm**  $17\frac{3}{4}'' \times 35\frac{3}{8}''$   $\nabla$  20 mm Ivory / Gold / Silver / Titanium

**60x60 cm**  $23\frac{5}{8}'' \times 23\frac{5}{8}''$   $\nabla$  20 mm Ivory / Gold / Silver / Titanium

**60x60 cm**  $23\frac{5}{8}'' \times 23\frac{5}{8}''$   $\nabla$  30 mm Gold / Silver / Titanium

**30x60 cm**  $11\frac{3}{4}'' \times 23\frac{5}{8}''$   $\nabla$  20 mm Ivory / Gold / Silver / Titanium



Ivory



Gold



Silver

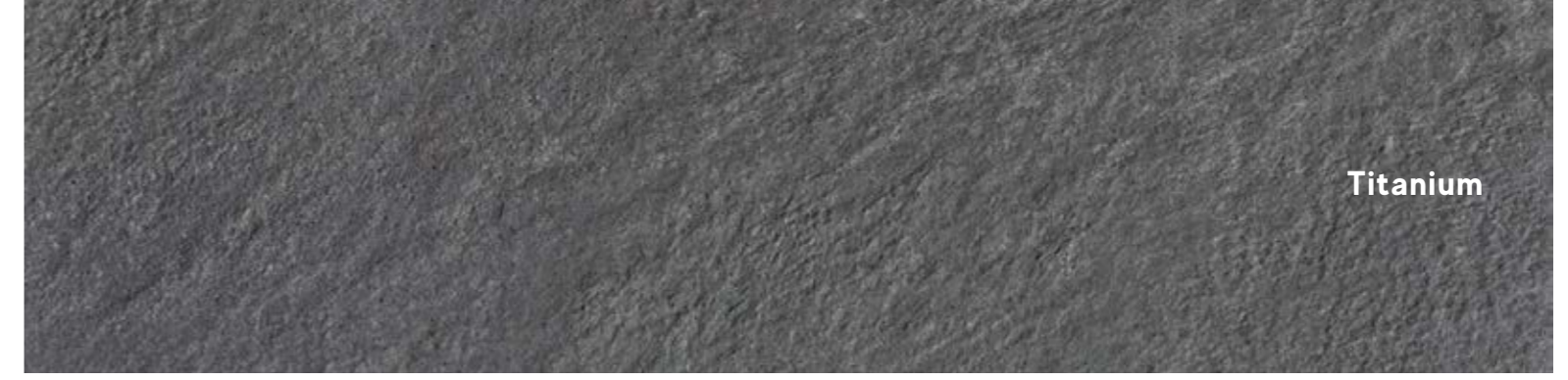

Titanium



# TRUST

COLOURED BODY PORCELAIN TILES / GRES PORCELLANATO COLORATO IN MASSA

Grès cérame coloré dans la masse . Durchgefärbtes Feinsteinzeug . Gres porcelánico coloreado en masa . Керамический гранит окрашенный в массе



## GRIP SURFACE / SUPERFICIE GRIP

Surface grip . Grip oberfläche . Superficie Grip . Grip поверхность

≙ 9 mm



30x60 cm

Rectified monocaliber . Rettificato monocalibro . Rectifié monocalibre . Rektifiziert Monokalibriert . Rectificado monocalibre . Одном калибре

30x60 cm 11<sup>3</sup>/<sub>4</sub>"x23<sup>5</sup>/<sub>8</sub>" ≙ 9 mm Moon / Ivory / Gold / Copper / Silver / Titanium

## DECORS



**Trust Brick 30x60 cm** 11<sup>3</sup>/<sub>4</sub>"x23<sup>5</sup>/<sub>8</sub>"  
Moon / Ivory / Gold / Copper / Silver / Titanium

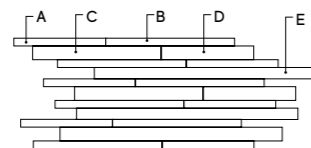

A: 2,1x24,8 cm - 3/<sub>4</sub>"x9<sup>3</sup>/<sub>4</sub>"  
B: 2,1x34,5 cm - 3/<sub>4</sub>"x13<sup>5</sup>/<sub>8</sub>"  
C: 3,3x34,5 cm - 1<sup>1</sup>/<sub>4</sub>"x13<sup>5</sup>/<sub>8</sub>"  
D: 3,3x24,8 cm - 1<sup>1</sup>/<sub>4</sub>"x9<sup>3</sup>/<sub>4</sub>"  
E: 2,5x60 cm - 1"x23<sup>5</sup>/<sub>8</sub>"



**Trust Mosaico 30x30 cm** 11<sup>3</sup>/<sub>4</sub>"x11<sup>3</sup>/<sub>4</sub>"  
Moon / Ivory / Gold / Copper / Silver / Titanium

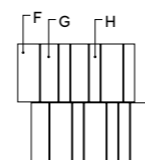

F: 5,6x14,7 cm - 2<sup>1</sup>/<sub>4</sub>"x5<sup>3</sup>/<sub>4</sub>"  
G: 4,5x14,7 cm - 1<sup>3</sup>/<sub>4</sub>"x5<sup>3</sup>/<sub>4</sub>"  
H: 2,8x14,7 cm - 1<sup>1</sup>/<sub>8</sub>"x5<sup>3</sup>/<sub>4</sub>"



Moon

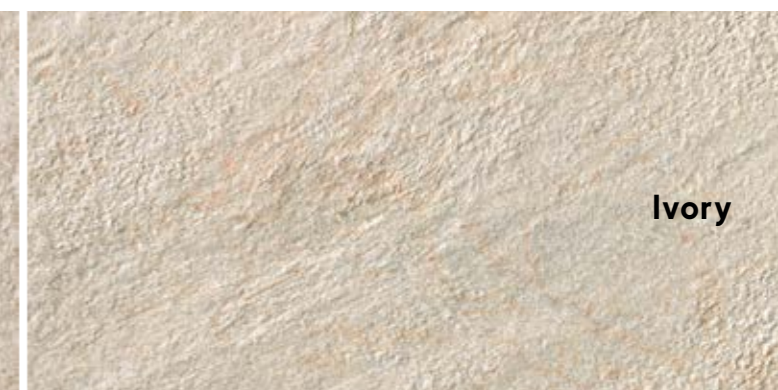

Ivory



Gold



Silver



Copper



Titanium

# BLOCK

COLOURED BODY PORCELAIN TILES / GRES PORCELLANATO COLORATO IN MASSA

Grès cérame coloré dans la masse . Durchgefärbtes Feinsteinzeug . Gres porcelánico coloreado en masa . Керамический гранит окрашенный в массе



V2  
SLIGHT  
VARIATION

## OUTDOOR PAVING / PAVIMENTI DA ESTERNO

Sols d'extérieur . Bodenbeläge für Außenbereiche . Pavimentos para exteriores . Уличная плитка

 20 mm

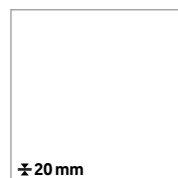

± 20 mm

60x60 cm

Rectified monocaliber . Rettificato monocalibro . Rectifié monocalibre . Rektifiziert Monokalibriert . Rectificado monocalibre . Одном калибре

60x60 cm 23<sup>5</sup>/<sub>8</sub>"x23<sup>5</sup>/<sub>8</sub>" ± 20 mm Bianco / Beige / Grigio



Bianco



Beige

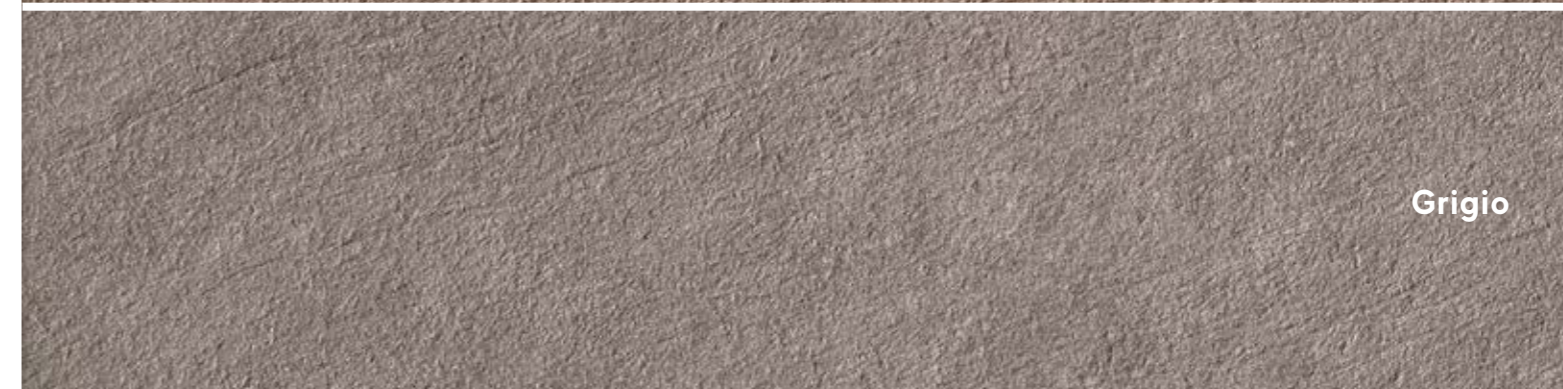

Grigio

# BLOCK

COLOURED BODY PORCELAIN TILES / GRES PORCELLANATO COLORATO IN MASSA

Grès cérame colorés dans la masse . Durchgefärbtes Feinsteinzeug . Gres porcelánico coloreado en masa . Керамический гранит окрашенный в массе



## TEXTURED SURFACE / SUPERFICIE STRUTTURATA

Surface structuré . Strukturiert oberfläche . Superficie estructurado . Структурная поверхность

± 8 mm / 8,6 mm

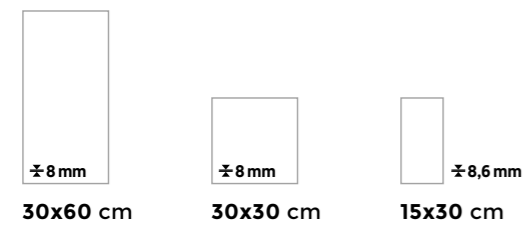

Not rectified monocaliber . Non rettificato monocalibro . Non rectifié monocalibre . Nicht Rektifiziert Monokalibriert . No Rectificado monocalibre . Неретифицированные

**30x60 cm** 11<sup>3</sup>/<sub>4</sub>"x23<sup>5</sup>/<sub>8</sub>" ± 8 mm Bianco / Beige / Grigio / Fumo

**30x30 cm** 11<sup>3</sup>/<sub>4</sub>"x11<sup>3</sup>/<sub>4</sub>" ± 8 mm Bianco / Beige / Grigio / Fumo

**15x30 cm** 5<sup>7</sup>/<sub>8</sub>"x11<sup>3</sup>/<sub>4</sub>" ± 8,6 mm Bianco / Beige / Grigio / Fumo

## DECORS



**Block Brick 29,5x60 cm** 11<sup>5</sup>/<sub>8</sub>"x23<sup>5</sup>/<sub>8</sub>"  
Bianco / Beige / Grigio / Fumo

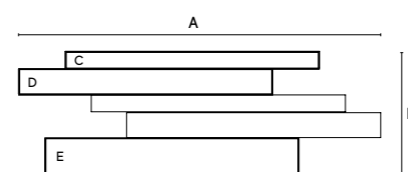

A: 85,5 cm - 33<sup>3</sup>/<sub>8</sub>"  
B: 29 cm - 11<sup>1</sup>/<sub>8</sub>"  
C: 4x60 cm - 1<sup>5</sup>/<sub>8</sub>"x23<sup>5</sup>/<sub>8</sub>"  
D: 5,9x60 cm - 2<sup>1</sup>/<sub>8</sub>"x23<sup>5</sup>/<sub>8</sub>"  
E: 8,37x60 cm - 3<sup>1</sup>/<sub>8</sub>"x23<sup>5</sup>/<sub>8</sub>"



# DIESIS

COLOURED BODY PORCELAIN TILES / GRES PORCELLANATO COLORATO IN MASSA

Grès cérame coloré dans la masse . Durchgefärbtes Feinsteinzeug . Gres porcelánico coloreado en masa . Керамический гранит окрашенный в массе



## OUTDOOR PAVING / PAVIMENTI DA ESTERNO

Sols d'extérieur . Bodenbeläge für Außenbereiche . Pavimentos para exteriores . Уличная плитка

 20 mm

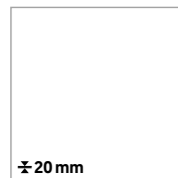

60x60 cm

Rectified monocaliber . Rettificato monocalibro . Rectifié monocalibre . Rektifiziert Monokalibriert . Rectificado monocalibre . Одном калибре

60x60 cm  $23\frac{5}{8} \times 23\frac{5}{8}$ "  20 mm Avorio / Beige / Greige



Avorio



Beige



Greige

# DIESIS

COLOURED BODY PORCELAIN TILES / GRES PORCELLANATO COLORATO IN MASSA

Grès cérame coloré dans la masse . Durchgefärbtes Feinsteinzeug . Gres porcelánico coloreado en masa . Керамический гранит окрашенный в массе

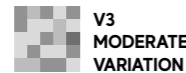

V3  
MODERATE  
VARIATION

## GRIP SURFACE / SUPERFICIE GRIP

Surface grip . Grip oberfläche . Superficie Grip . Grip поверхность

8 mm



± 8 mm

30x60 cm

Rectified monocaliber . Rettificato monocalibro . Rectifié monocalibre . Rektifiziert Monokalibriert . Rectificado monocalibre . Одном калибре

30x60 cm 11<sup>3</sup>/<sub>4</sub>"x23<sup>5</sup>/<sub>8</sub>" ± 8 mm Avorio / Beige / Greige



Avorio



Beige



Greige

# KAVA

COLOURED BODY PORCELAIN TILES / GRES PORCELLANATO COLORATO IN MASSA

Grès cérame coloré dans la masse . Durchgefärbtes Feinsteinzeug . Gres porcelánico coloreado en masa . Керамический гранит окрашенный в массе



R11  
A+B+C



H  
HEAVY  
TRAFFIC



V3  
MODERATE  
VARIATION

## OUTDOOR PAVING / PAVIMENTI DA ESTERNO

Sols d'extérieur . Bodenbeläge für Außenbereiche . Pavimentos para exteriores . Уличная плитка

 20 mm

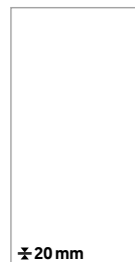

± 20 mm

45x90 cm

Rectified monocaliber . Rettificato monocalibro . Rectifié monocalibre . Rektifiziert Monokalibriert . Rectificado monocalibre . Одном калибре

45x90 cm 17<sup>3</sup>/<sub>4</sub>"x35<sup>3</sup>/<sub>8</sub>" ± 20 mm Ivory / Silver / Grey



Ivory



Silver



Grey

# KAVA

COLOURED BODY PORCELAIN TILES / GRES PORCELLANATO COLORATO IN MASSA

Grès cérame coloré dans la masse . Durchgefärbtes Feinsteinzeug . Gres porcelánico coloreado en masa . Керамический гранит окрашенный в массе

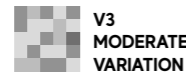

## TEXTURED SURFACE / SUPERFICIE STRUTTURATA

Surface structuré . Strukturiert oberfläche . Superficie estructurado . Структурная поверхность

$\nabla$  8 mm / 9 mm



± 8 mm

30x60 cm



± 9 mm

22,5x45,3 cm

Not rectified monocaliber . Non rettificato monocalibro . Non rectifié monocalibre . Nicht Rektifiziert Monokalibriert . No Rectificado monocalibre .  
Неретифицированные

**30x60 cm**  $11\frac{3}{4}'' \times 23\frac{5}{8}''$  ± 8 mm Ivory / Silver / Grey

**22,5x45,3 cm**  $8\frac{7}{8}'' \times 17\frac{3}{4}''$  ± 9 mm Ivory / Silver / Grey

## DECORS



**Kaca Brick 29,5x60 cm**  $11\frac{5}{8}'' \times 23\frac{5}{8}''$   
Ivory / Silver / Grey

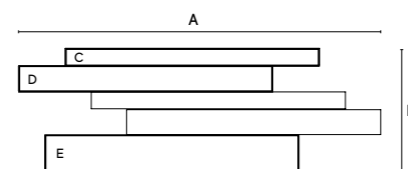

A: 85,5 cm -  $33\frac{3}{8}''$   
B: 29 cm -  $11\frac{3}{8}''$   
C: 4x60 cm -  $1\frac{1}{8}'' \times 23\frac{5}{8}''$   
D: 5,9x60 cm -  $2\frac{1}{8}'' \times 23\frac{5}{8}''$   
E: 8,37x60 cm -  $3\frac{3}{8}'' \times 23\frac{5}{8}''$



Ivory



Silver



Grey

# ARKSHADE

COLOURED BODY PORCELAIN TILES / GRES PORCELLANATO COLORATO IN MASSA

Grès cérame coloré dans la masse . Durchgefärbtes Feinsteinzeug . Gres porcelánico coloreado en masa . Керамический гранит окрашенный в массе



R11  
A+B

HEAVY  
TRAFFIC

V1  
UNIFORM  
APPEARANCE

## GRIP SURFACE / SUPERFICIE GRIP

Surface grip . Grip oberfläche . Superficie Grip . Grip поверхность

9 mm



30x60 cm

Rectified monocaliber . Rettificato monocalibro . Rectifié monocalibre . Rektifiziert Monokalibriert . Rectificado monocalibre . Одном калибре

30x60 cm 11<sup>3</sup>/<sub>4</sub>"x23<sup>5</sup>/<sub>8</sub>" 9 mm White / Lead / Grey / Clay / Dove

## DECORS



Arkshade Listello 8x60 cm 3<sup>1</sup>/<sub>8</sub>"x23<sup>5</sup>/<sub>8</sub>"

White / Lead / Grey / Clay / Dove



White

Grey

Clay

Dove

Lead

CONCRETE & RESIN LOOK



# BOOST

COLOURED BODY PORCELAIN TILES / GRES PORCELLANATO COLORATO IN MASSA

Grès cérame coloré dans la masse . Durchgefärbtes Feinsteinzeug . Gres porcelánico coloreado en masa . Керамический гранит окрашенный в массе



## OUTDOOR PAVING / PAVIMENTI DA ESTERNO

Sols d'extérieur . Bodenbeläge für Außenbereiche . Pavimentos para exteriores . Уличная плитка

20 mm



120x240 cm

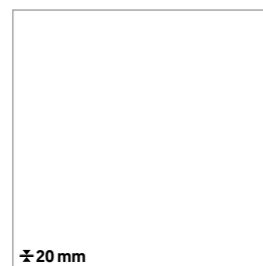

± 20 mm

90x90 cm

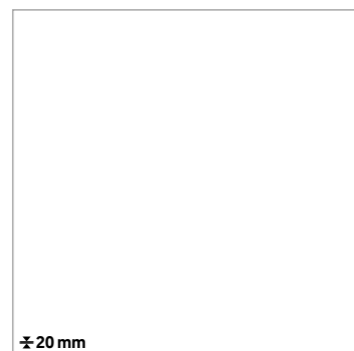

± 20 mm

120x120 cm



± 20 mm

60x120 cm



± 20 mm

60x60 cm

Rectified monocaliber . Rettificato monocalibro . Rectifié monocalibre . Rektifiziert Monokalibriert . Rectificado monocalibre . Одном калибре

**120x240 cm** 47<sup>1</sup>/<sub>4</sub>"x94<sup>1</sup>/<sub>2</sub>" ± 20 mm White / Grey

**120x120 cm** 47<sup>1</sup>/<sub>4</sub>"x47<sup>1</sup>/<sub>4</sub>" ± 20 mm White / Grey / Smoke / Tarmac

**60x120 cm** 23<sup>5</sup>/<sub>8</sub>"x47<sup>1</sup>/<sub>4</sub>" ± 20 mm White / Grey / Smoke / Tarmac

**90x90 cm** 35<sup>3</sup>/<sub>8</sub>"x35<sup>3</sup>/<sub>8</sub>" ± 20 mm White / Grey / Smoke / Tarmac

**60x60 cm** 23<sup>5</sup>/<sub>8</sub>"x23<sup>5</sup>/<sub>8</sub>" ± 20 mm White / Grey / Smoke / Tarmac



White

Grey

Smoke

Tarmac

CONCRETE & RESIN LOOK

# BOOST

COLOURED BODY PORCELAIN TILES / GRES PORCELLANATO COLORATO IN MASSA

Grès cérame coloré dans la masse . Durchgefärbtes Feinsteinzeug . Gres porcelánico coloreado en masa . Керамический гранит окрашенный в массе



## GRIP SURFACE / SUPERFICIE GRIP

Surface grip . Grip oberfläche . Superficie Grip . Grip поверхность

9 mm

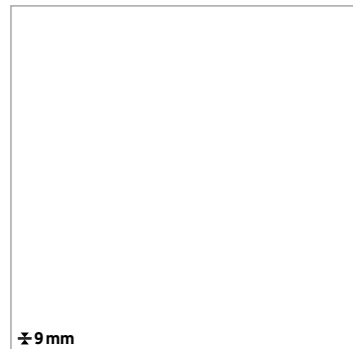

± 9 mm

120x120 cm

Rectified monocaliber . Rettificato monocalibro . Rectifié monocalibre . Rektifiziert Monokalibriert . Rectificado monocalibre . Одном калибре

120x120 cm 47 1/4" x 47 1/4" ± 9 mm White / Pearl / Grey / Smoke / Tarmac



White



Pearl



Grey



Smoke



Tarmac

CONCRETE & RESIN LOOK

# BOOST PRO

COLOURED BODY PORCELAIN TILES / GRES PORCELLANATO COLORATO IN MASSA

Grès cérame coloré dans la masse . Durchgefärbtes Feinsteinzeug . Gres porcelánico coloreado en masa . Керамический гранит окрашенный в массе



## OUTDOOR PAVING / PAVIMENTI DA ESTERNO

Sols d'extérieur . Bodenbeläge für Außenbereiche . Pavimentos para exteriores . Уличная плитка

20 mm

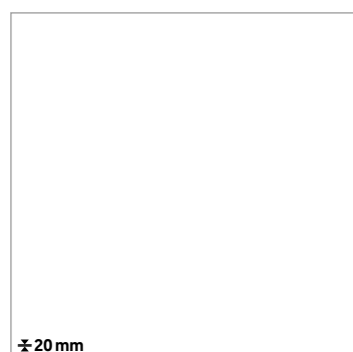

120x120 cm



60x120 cm

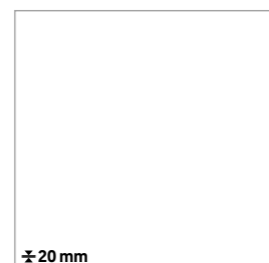

90x90 cm



60x60 cm

Rectified monocaliber . Rettificato monocalibro . Rectifié monocalibre . Rektifiziert Monokalibriert . Rectificado monocalibre . Одном калибре

**120x120 cm** 47<sup>1</sup>/<sub>4</sub>"x47<sup>1</sup>/<sub>4</sub>" 20 mm Cream / Clay / Taupe / Tobacco

**60x120 cm** 23<sup>5</sup>/<sub>8</sub>"x47<sup>1</sup>/<sub>4</sub>" 20 mm Cream / Clay / Taupe / Tobacco

**90x90 cm** 35<sup>3</sup>/<sub>8</sub>"x35<sup>3</sup>/<sub>8</sub>" 20 mm Cream / Clay / Taupe / Tobacco

**60x60 cm** 23<sup>5</sup>/<sub>8</sub>"x23<sup>5</sup>/<sub>8</sub>" 20 mm Cream / Clay / Taupe / Tobacco



Cream



Clay



Taupe



Tobacco

CONCRETE & RESIN LOOK

# BOOST PRO

COLOURED BODY PORCELAIN TILES / GRES PORCELLANATO COLORATO IN MASSA

Grès cérame coloré dans la masse . Durchgefärbtes Feinsteinzeug . Gres porcelánico coloreado en masa . Керамический гранит окрашенный в массе



## GRIP SURFACE / SUPERFICIE GRIP

Surface grip . Grip oberfläche . Superficie Grip . Grip поверхность

9 mm

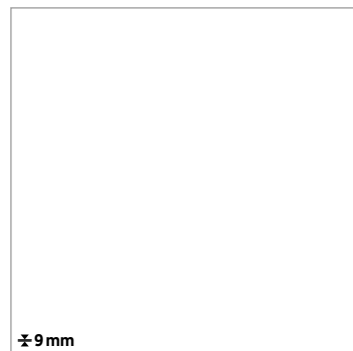

± 9 mm

120x120 cm

Rectified monocaliber . Rettificato monocalibro . Rectifié monocalibre . Rektifiziert Monokalibriert . Rectificado monocalibre . Одном калибре

120x120 cm 47 1/4" x 47 1/4" ± 9 mm Ivory / Cream / Clay / Taupe / Tobacco



Ivory



Cream



Clay



Taupe



Tobacco

CONCRETE & RESIN LOOK

# DWELL

COLOURED BODY PORCELAIN TILES / GRES PORCELLANATO COLORATO IN MASSA

Grès cérame coloré dans la masse . Durchgefärbtes Feinsteinzeug . Gres porcelánico coloreado en masa . Керамический гранит окрашенный в массе



V2  
SLIGHT  
VARIATION

## OUTDOOR PAVING / PAVIMENTI DA ESTERNO

Sols d'extérieur . Bodenbeläge für Außenbereiche . Pavimentos para exteriores . Уличная плитка

20 mm

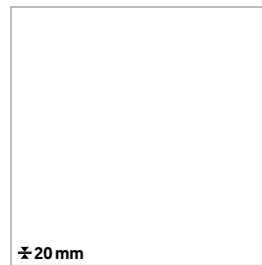

$\pm 20$  mm

90x90 cm

Rectified monocaliber . Rettificato monocalibro . Rectifié monocalibre . Rektifiziert Monokalibriert . Rectificado monocalibre . Одном калибре

90x90 cm  $35\frac{5}{8} \times 35\frac{5}{8}$ "  $\pm 20$  mm Off White / Pearl / Gray / Smoke

## DECORS



Dwell Listello 8x60 cm  $3\frac{1}{8} \times 23\frac{5}{8}$ "

Off White / Pearl / Gray / Dwell Smoke



Off White



Pearl



Gray



Smoke

CONCRETE & RESIN LOOK

# PRISM

COLOURED BODY PORCELAIN TILES / GRES PORCELLANATO COLORATO IN MASSA

Grès cérame coloré dans la masse . Durchgefärbtes Feinsteinzeug . Gres porcelánico coloreado en masa . Керамический гранит окрашенный в массе



## OUTDOOR PAVING / PAVIMENTI DA ESTERNO

Sols d'extérieur . Bodenbeläge für Außenbereiche . Pavimentos para exteriores . Уличная плитка

20 mm

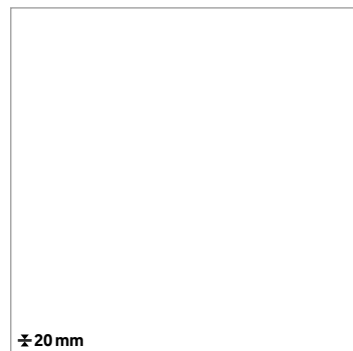

120x120 cm

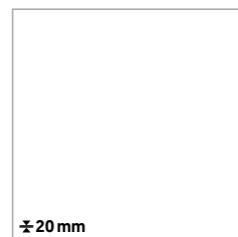

80x80 cm

Rectified monocaliber . Rettificato monocalibro . Rectifié monocalibre . Rektifiziert Monokalibriert . Rectificado monocalibre . Одном калибре

**120x120 cm** 47<sup>1</sup>/<sub>4</sub>"x47<sup>1</sup>/<sub>4</sub>"  $\pm$  20 mm Cord / Cloud / Fog / Suede

**80x80 cm** 31<sup>1</sup>/<sub>2</sub>"x31<sup>1</sup>/<sub>2</sub>"  $\pm$  20 mm Cord / Cloud / Fog / Suede

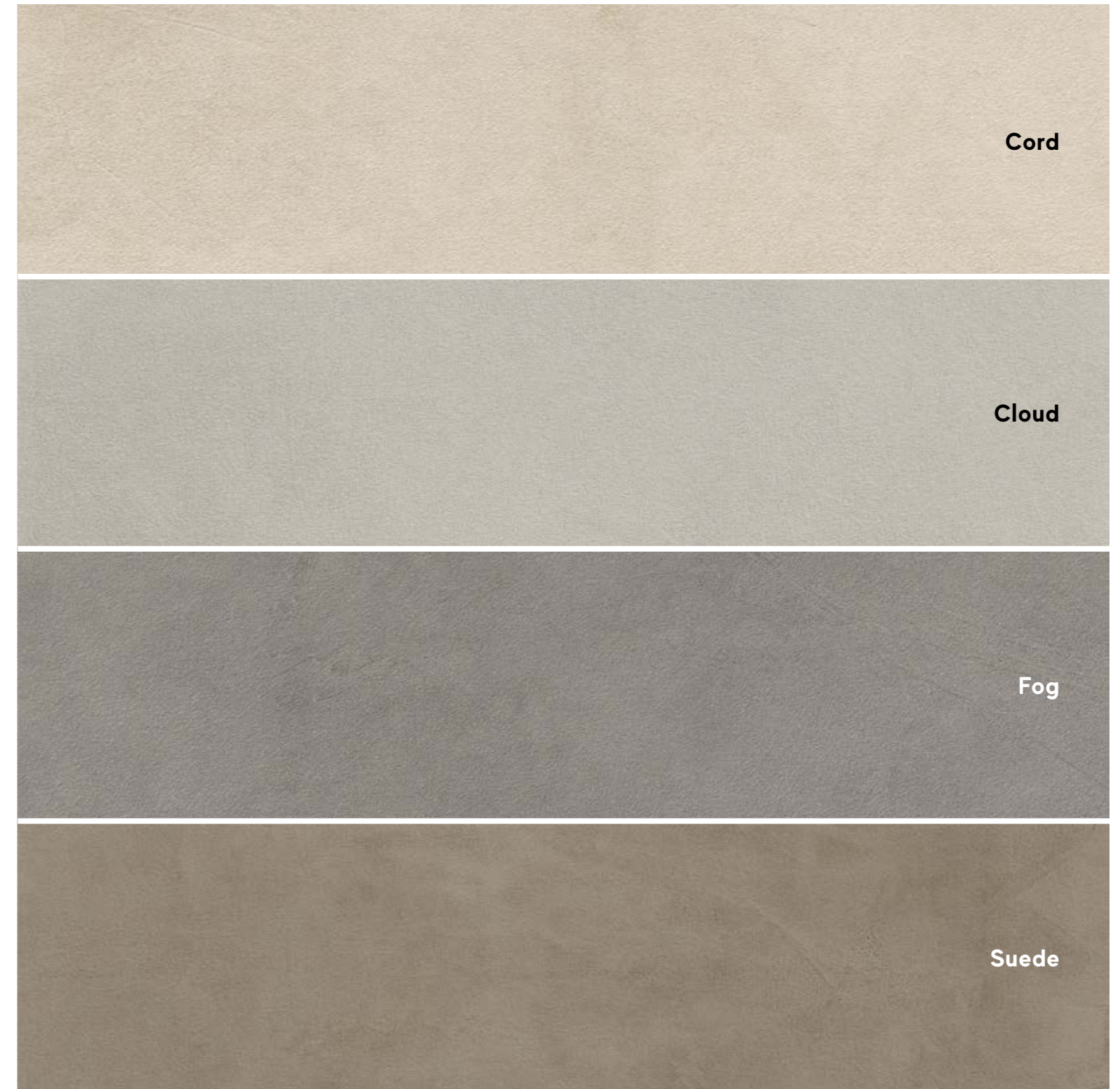

Cord

Cloud

Fog

Suede

CONCRETE & RESIN LOOK

# PRISM

COLOURED BODY PORCELAIN TILES / GRES PORCELLANATO COLORATO IN MASSA

Grès cérame coloré dans la masse . Durchgefärbtes Feinsteinzeug . Gres porcelánico coloreado en masa . Керамический гранит окрашенный в массе



V2  
SLIGHT  
VARIATION

## GRIP SURFACE / SUPERFICIE GRIP

Surface grip . Grip oberfläche . Superficie Grip . Grip поверхность

9 mm

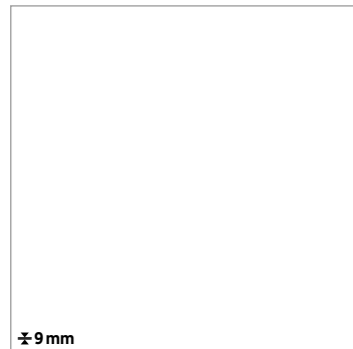

± 9 mm

120x120 cm

Rectified monocaliber . Rettificato monocalibro . Rectifié monocalibre . Rektifiziert Monokalibriert . Rectificado monocalibre . Одном калибре

120x120 cm 47 1/4" x 47 1/4" ± 9 mm Cord / Cloud / Fog / Suede

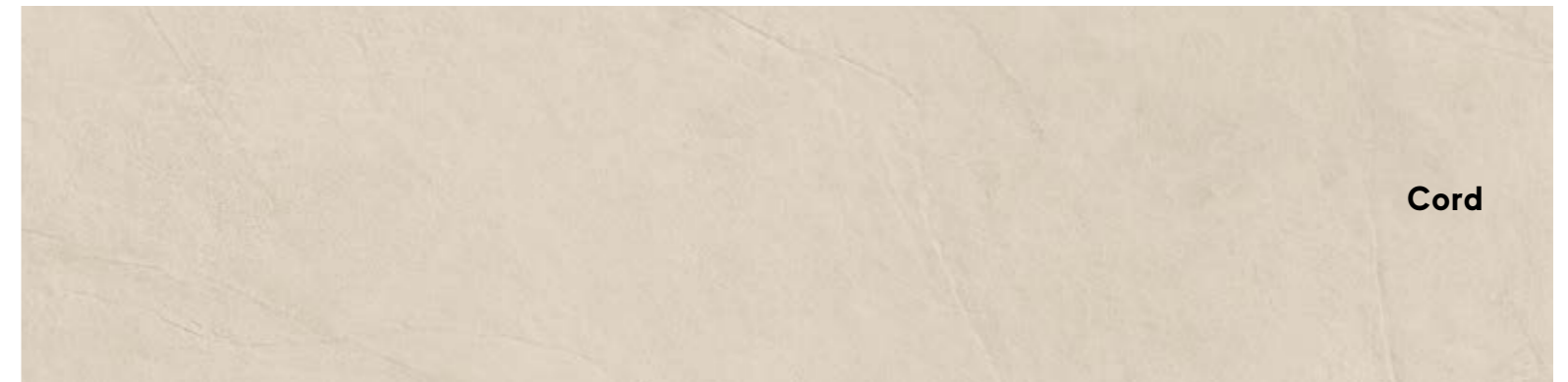

Cord



Cloud



Fog



Suede

CONCRETE & RESIN LOOK

# RAW

COLOURED BODY PORCELAIN TILES / GRES PORCELLANATO COLORATO IN MASSA

Grès cérame coloré dans la masse . Durchgefärbtes Feinsteinzeug . Gres porcelánico coloreado en masa . Керамический гранит окрашенный в массе



## OUTDOOR PAVING / PAVIMENTI DA ESTERNO

Sols d'extérieur . Bodenbeläge für Außenbereiche . Pavimentos para exteriores . Уличная плитка

20 mm

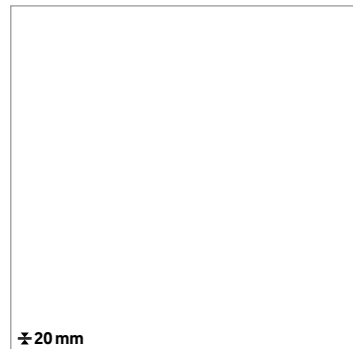

120x120 cm

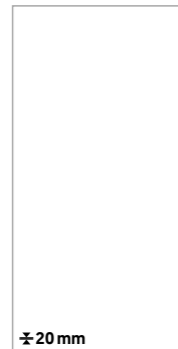

60x120 cm

Rectified monocaliber . Rettificato monocalibro . Rectifié monocalibre . Rektifiziert Monokalibriert . Rectificado monocalibre . Одном калибре

**120x120 cm** 47<sup>1</sup>/<sub>4</sub>"x47<sup>1</sup>/<sub>4</sub>" 20 mm White / Pearl / Sand / Mud

**60x120 cm** 23<sup>5</sup>/<sub>8</sub>"x47<sup>1</sup>/<sub>4</sub>" 20 mm White / Pearl / Sand / Mud



White



Pearl



Sand



Mud

CONCRETE & RESIN LOOK



# RAW

COLOURED BODY PORCELAIN TILES / GRES PORCELLANATO COLORATO IN MASSA

Grès cérame coloré dans la masse . Durchgefärbtes Feinsteinzeug . Gres porcelánico coloreado en masa . Керамический гранит окрашенный в массе



## GRIP SURFACE / SUPERFICIE GRIP

Surface grip . Grip oberfläche . Superficie Grip . Grip поверхность

9 mm



37,5x75 cm

Rectified monocaliber . Rettificato monocalibro . Rectifié monocalibre . Rektifiziert Monokalibriert . Rectificado monocalibre . Одном калибре

37,5x75 cm 14<sup>3</sup>/<sub>4</sub>"x29<sup>1</sup>/<sub>2</sub>" 9 mm White / Pearl / Sand / Mud



White



Pearl



Sand



Mud

CONCRETE & RESIN LOOK

# FLUX

COLOURED BODY PORCELAIN TILES / GRES PORCELLANATO COLORATO IN MASSA

Grès cérame coloré dans la masse . Durchgefärbtes Feinsteinzeug . Gres porcelánico coloreado en masa . Керамический гранит окрашенный в массе



## OUTDOOR PAVING / PAVIMENTI DA ESTERNO

Sols d'extérieur . Bodenbeläge für Außenbereiche . Pavimentos para exteriores . Уличная плитка

 20 mm



60x60 cm

Rectified monocaliber . Rettificato monocalibro . Rectifié monocalibre . Rektifiziert Monokalibriert . Rectificado monocalibre . Одном калибре

60x60 cm 23<sup>5</sup>/<sub>8</sub>"x23<sup>5</sup>/<sub>8</sub>"  20 mm Bone / Concrete / Coke



Bone



Concrete



Coke

CONCRETE & RESIN LOOK

# FLUX

COLOURED BODY PORCELAIN TILES / GRES PORCELLANATO COLORATO IN MASSA

Grès cérame coloré dans la masse . Durchgefärbtes Feinsteinzeug . Gres porcelánico coloreado en masa . Керамический гранит окрашенный в массе



## GRIP SURFACE / SUPERFICIE GRIP

Surface grip . Grip oberfläche . Superficie Grip . Grip поверхность

8 mm



30x60 cm

Rectified monocaliber . Rettificato monocalibro . Rectifié monocalibre . Rektifiziert Monokalibriert . Rectificado monocalibre . Одном калибре

30x60 cm <sup>11<sup>3</sup>/<sub>4</sub>"x23<sup>5</sup>/<sub>8</sub>"</sup>  $\pm$  8 mm Bone / Sand / Concrete / Coke



Bone



Sand



Concrete



Coke

CONCRETE & RESIN LOOK

# ARBOR

COLOURED BODY PORCELAIN TILES / GRES PORCELLANATO COLORATO IN MASSA

Grès cérame coloré dans la masse . Durchgefärbtes Feinsteinzeug . Gres porcelánico coloreado en masa . Керамический гранит окрашенный в массе



R11  
A+B+C

H  
HEAVY  
TRAFFIC

V3  
MODERATE  
VARIATION

## GRIP SURFACE / SUPERFICIE GRIP

Surface grip . Grip oberfläche . Superficie Grip . Grip поверхность

± 9 mm



±9 mm

15x90 cm

Rectified monocaliber . Rettificato monocalibro . Rectifié monocalibre . Rektifiziert Monokalibriert . Rectificado monocalibre . Одном калибре

15x90 cm 5<sup>7</sup>/<sub>8</sub>"x35<sup>3</sup>/<sub>8</sub>" ± 9 mm Almond / Grey / Natural / Cognac / Arbor Tobacco

## DECORS

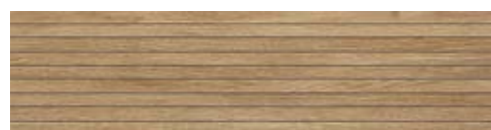

Arbor Tatami 22,5x90 cm 8<sup>7</sup>/<sub>8</sub>"x35<sup>3</sup>/<sub>8</sub>"

Arbor Almond / Arbor Grey / Arbor Natural /  
Arbor Cognac / Arbor Tobacco

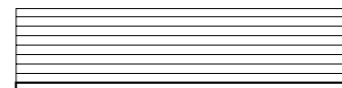

2,3x90 cm - 7<sup>1</sup>/<sub>8</sub>"x35<sup>3</sup>/<sub>8</sub>"



Almond



Grey



Natural



Cognac



Tobacco

# AXI

**COLOURED BODY PORCELAIN TILES / GRES PORCELLANATO COLORATO IN MASSA**

Grès cérame coloré dans la masse . Durchgefärbtes Feinsteinzeug . Gres porcelánico coloreado en masa . Керамический гранит окрашенный в массе



V2 SLIGHT VARIATION

White Pine / Grey Timber



V3 MODERATE VARIATION

Golden Oak / Brown Chestnut

**OUTDOOR PAVING / PAVIMENTI DA ESTERNO**

Sols d'extérieur . Bodenbeläge für Außenbereiche . Pavimentos para exteriores . Уличная плитка

20 mm

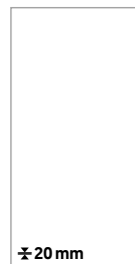

45x90 cm

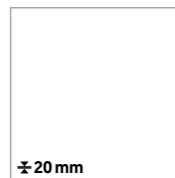

60x60 cm

Rectified monocaliber . Rettificato monocalibro . Rectifié monocalibre . Rektifiziert Monokalibriert . Rectificado monocalibre . Одном калибре

**45x90 cm** 17<sup>3</sup>/<sub>4</sub>"x35<sup>3</sup>/<sub>8</sub>" 20 mm White Pine / Grey Timber / Golden Oak / Brown Chestnut

**60x60 cm** 23<sup>5</sup>/<sub>8</sub>"x23<sup>5</sup>/<sub>8</sub>" 20 mm Grey Timber / Brown Chestnut



White Pine

Grey Timber

Brown Chestnut

Golden Oak

WOOD LOOK

# AXI

COLOURED BODY PORCELAIN TILES / GRES PORCELLANATO COLORATO IN MASSA

Grès cérame coloré dans la masse . Durchgefärbtes Feinsteinzeug . Gres porcelánico coloreado en masa . Керамический гранит окрашенный в массе



V2  
SLIGHT  
VARIATION

White Pine / Grey Timber



V3  
MODERATE  
VARIATION

Silver Fir / Golden Oak / Brown Chestnut / Dark Oak

## TEXTURED SURFACE / SUPERFICIE STRUTTURATA

Surface structuré . Strukturiert oberfläche . Superficie estructurado . Структурная поверхность

≙ 9,5 mm



≙ 9,5 mm

22,5x90 cm

Rectified monocaliber . Rettificato monocalibro . Rectifié monocalibre . Rektifiziert Monokalibriert . Rectificado monocalibre . Одном калибре

22,5x90 cm  $8\frac{7}{8}'' \times 35\frac{3}{8}''$  ≙ 9,5 mm White Pine / Silver Fir / Grey Timber / Golden Oak / Brown Chestnut / Dark Oak

## DECORS



**Axi Tatami 22,5x90 cm**  $8\frac{7}{8}'' \times 35\frac{3}{8}''$

White Pine / Silver Fir / Grey Timber / Golden Oak / Brown Chestnut / Dark Oak



**Axi Treccia 28x53 cm**  $11'' \times 20\frac{7}{8}''$

White Pine / Silver Fir / Grey Timber / Golden Oak / Brown Chestnut / Dark Oak

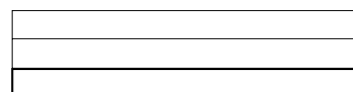

7,2x89,5 cm -  $2\frac{7}{8}'' \times 35\frac{1}{4}''$

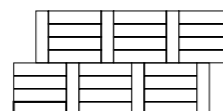

3,3x14 cm -  $1\frac{1}{4}'' \times 5\frac{1}{2}''$



White Pine



Silver Fir

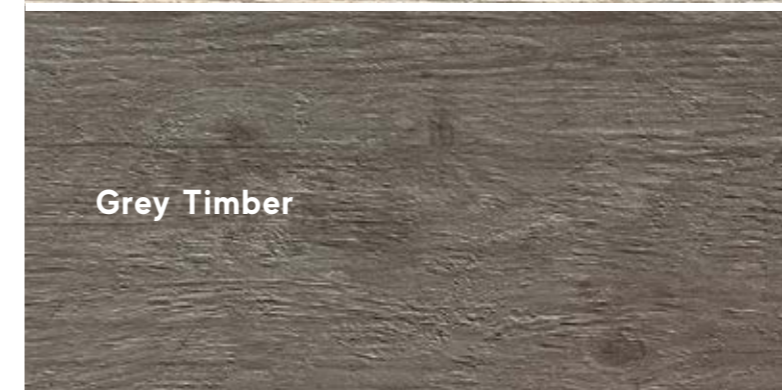

Grey Timber



Golden Oak



Brown Chestnut

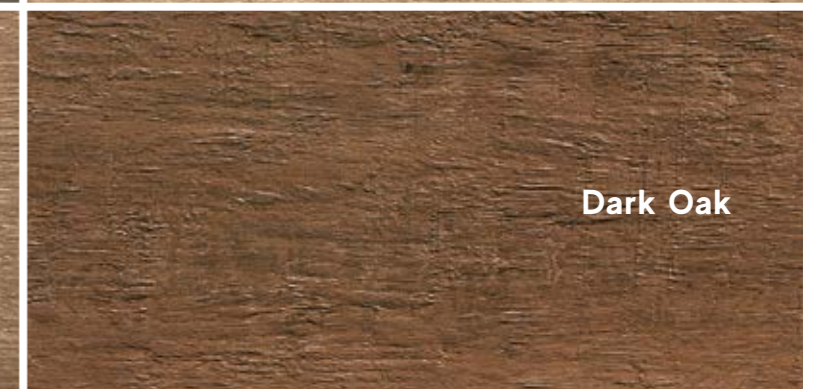

Dark Oak

# ETIC PRO

COLOURED BODY PORCELAIN TILES / GRES PORCELLANATO COLORATO IN MASSA

Grès cérame coloré dans la masse . Durchgefärbtes Feinsteinzeug . Gres porcelánico coloreado en masa . Керамический гранит окрашенный в массе



## OUTDOOR PAVING / PAVIMENTI DA ESTERNO

Sols d'extérieur . Bodenbeläge für Außenbereiche . Pavimentos para exteriores . Уличная плитка

 20 mm



Rovere Venice

Noce Hickory



30x120 cm

Rectified monocaliber . Rettificato monocalibro . Rectifié monocalibre . Rektifiziert Monokalibriert . Rectificado monocalibre . Одном калибре

30x120 cm 11<sup>3</sup>/<sub>4</sub>"x47<sup>1</sup>/<sub>4</sub>"  20 mm Rovere Venice / Noce Hickory

# ETIC PRO

COLOURED BODY PORCELAIN TILES / GRES PORCELLANATO COLORATO IN MASSA

Grès cérame coloré dans la masse . Durchgefärbtes Feinsteinzeug . Gres porcelánico coloreado en masa . Керамический гранит окрашенный в массе



## GRIP SURFACE / SUPERFICIE GRIP

Surface grip . Grip oberfläche . Superficie Grip . Grip поверхность

9 mm



±9mm

22,5x90 cm

Rectified monocaliber . Rettificato monocalibro . Rectifié monocalibre . Rektifiziert Monokalibriert . Rectificado monocalibre . Одном калибре

22,5x90 cm 8<sup>7</sup>/<sub>8</sub>"x35<sup>3</sup>/<sub>8</sub>" ± 9 mm Rovere Venice / Noce Hickory



## DECORS



Etic Pro Tatami 22,5x90 cm 8<sup>7</sup>/<sub>8</sub>"x35<sup>3</sup>/<sub>8</sub>"  
Rovere Venice / Noce Hickory

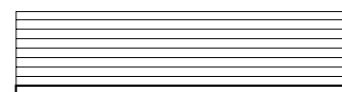

2,3x90 cm - 7<sup>1</sup>/<sub>8</sub>"x35<sup>3</sup>/<sub>8</sub>"



# EXENCE

COLOURED BODY PORCELAIN TILES / GRES PORCELLANATO COLORATO IN MASSA

Grès cérame coloré dans la masse . Durchgefärbtes Feinsteinzeug . Gres porcelánico coloreado en masa . Керамический гранит окрашенный в массе



## OUTDOOR PAVING / PAVIMENTI DA ESTERNO

Sols d'extérieur . Bodenbeläge für Außenbereiche . Pavimentos para exteriores . Уличная плитка

 20 mm



Almond



Amber



 20 mm

30x120 cm

Rectified monocaliber . Rettificato monocalibro . Rectifié monocalibre . Rektifiziert Monokalibriert . Rectificado monocalibre . Одном калибре

30x120 cm  $11\frac{3}{4} \times 47\frac{1}{4}$   20 mm Almond / Amber

# EXENCE

COLOURED BODY PORCELAIN TILES / GRES PORCELLANATO COLORATO IN MASSA

Grès cérame coloré dans la masse . Durchgefärbtes Feinsteinzeug . Gres porcelánico coloreado en masa . Керамический гранит окрашенный в массе



R11  
A+B+C



H  
HEAVY  
TRAFFIC



V2  
SLIGHT  
VARIATION

## GRIP SURFACE / SUPERFICIE GRIP

Surface grip . Grip oberfläche . Superficie Grip . Grip поверхность

9 mm



± 9 mm

18,5x150 cm

Rectified monocaliber . Rettificato monocalibro . Rectifié monocalibre . Rektifiziert Monokalibriert . Rectificado monocalibre . Одном калибре

18,5x150 cm 7 1/4" x 59" ± 9 mm Vanilla / Almond / Amber



Vanilla

Almond

Amber

WOOD LOOK

## DECORS

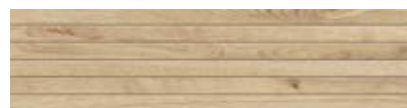

Exence Tatami 18,5x75 cm 7 1/4" x 29 1/2"  
Vanilla / Almond / Amber



2,85x74,4 cm - 1 1/8" x 29 1/8"

# NASH

COLOURED BODY PORCELAIN TILES / GRES PORCELLANATO COLORATO IN MASSA

Grès cérame coloré dans la masse . Durchgefärbtes Feinsteinzeug . Gres porcelánico coloreado en masa . Керамический гранит окрашенный в массе



## GRIP SURFACE / SUPERFICIE GRIP

Surface grip . Grip oberfläche . Superficie Grip . Grip поверхность

9 mm



±9 mm

20x120 cm

Rectified monocaliber . Rettificato monocalibro . Rectifié monocalibre . Rektifiziert Monokalibriert . Rectificado monocalibre . Одном калибре

20x120 cm 7<sup>7</sup>/<sub>8</sub>"x47<sup>1</sup>/<sub>4</sub>" ± 9 mm White Wood / Greige / Gray Wood / Dark Oak / Light Brown



White Wood



Greige



Gray Wood



Dark Oak



Light Brown

# BLAZE

COLOURED BODY PORCELAIN TILES / GRES PORCELLANATO COLORATO IN MASSA

Grès cérame coloré dans la masse . Durchgefärbtes Feinsteinzeug . Gres porcelánico coloreado en masa . Керамический гранит окрашенный в массе



## OUTDOOR PAVING / PAVIMENTI DA ESTERNO

Sols d'extérieur . Bodenbeläge für Außenbereiche . Pavimentos para exteriores . Уличная плитка

20 mm

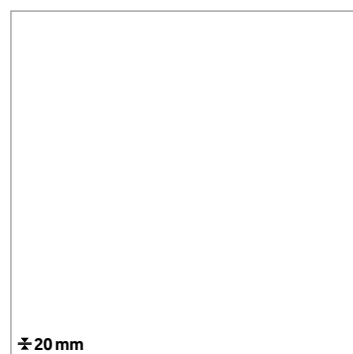

120x120 cm



60x60 cm

Rectified monocaliber . Rettificato monocalibro . Rectifié monocalibre . Rektifiziert Monokalibriert . Rectificado monocalibre . Одном калибре

**120x120 cm** 47<sup>1</sup>/<sub>4</sub>"x47<sup>1</sup>/<sub>4</sub>" 20 mm Corten

**60x60 cm** 23<sup>5</sup>/<sub>8</sub>"x23<sup>5</sup>/<sub>8</sub>" 20 mm Corten

## GRIP SURFACE / SUPERFICIE GRIP

Surface grip . Grip oberfläche . Superficie Grip . Grip поверхность

9 mm



37,5x75 cm

Rectified monocaliber . Rettificato monocalibro . Rectifié monocalibre . Rektifiziert Monokalibriert . Rectificado monocalibre . Одном калибре

**37,5x75 cm** 14<sup>3</sup>/<sub>4</sub>"x29<sup>1</sup>/<sub>2</sub>" 9 mm Aluminium / Iron / Corten

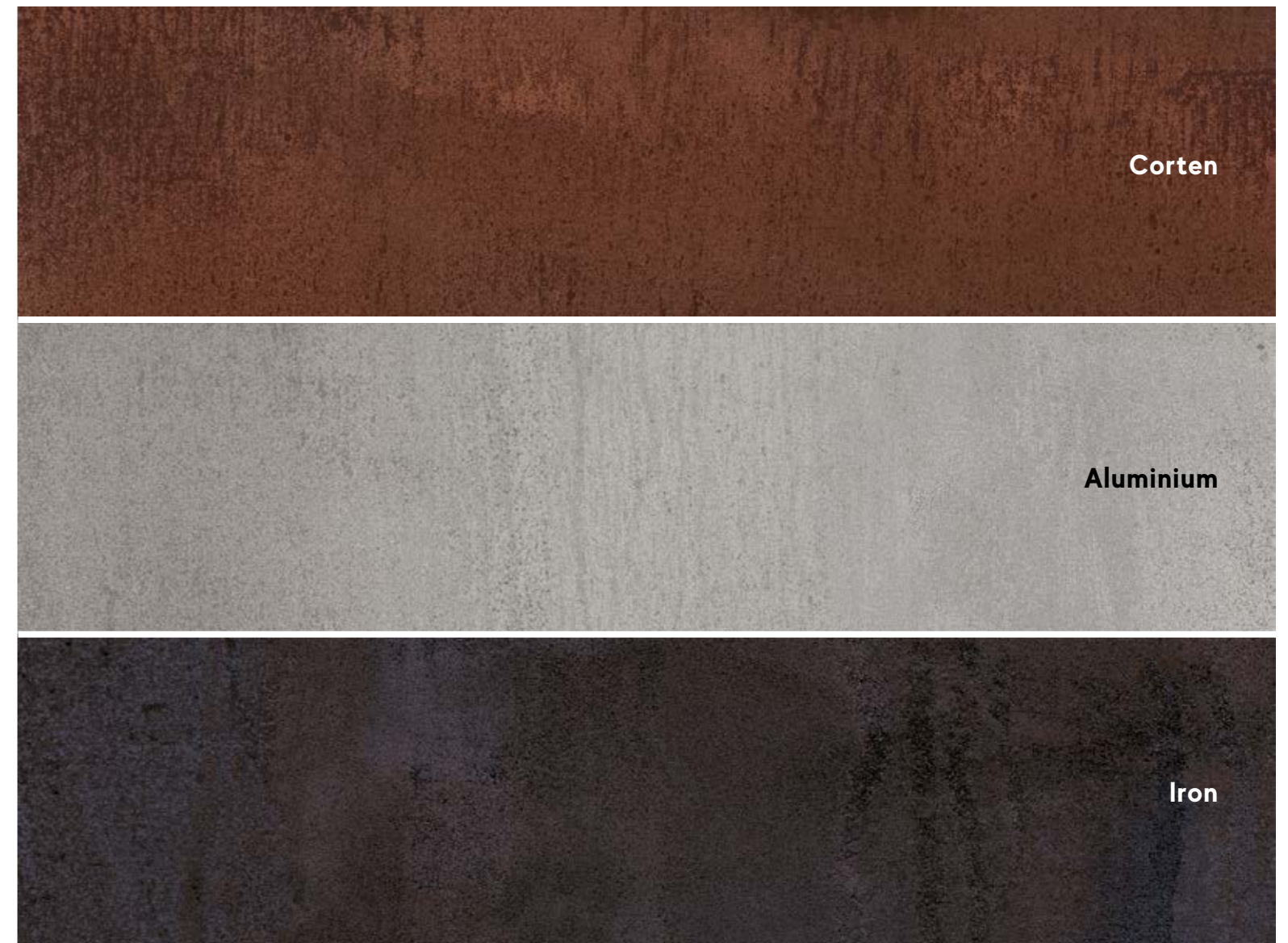

Corten

Aluminium

Iron

# MARVEL PRO

COLOURED BODY PORCELAIN TILES / GRES PORCELLANATO COLORATO IN MASSA

Grès cérame coloré dans la masse . Durchgefärbtes Feinsteinzeug . Gres porcelánico coloreado en masa . Керамический гранит окрашенный в массе



V2 SLIGHT VARIATION



V3 MODERATE VARIATION

Crema Delicato

Statuario Select / Grey Fleury

## TEXTURED SURFACE / SUPERFICIE STRUTTURATA

Surface structuré . Strukturiert oberfläche . Superficie estructurado . Структурная поверхность

≠ 9 mm



30x60 cm

Rectified monocaliber . Rettificato monocalibro . Rectifié monocalibre . Rektifiziert Monokalibriert . Rectificado monocalibre . Одном калибре

30x60 cm 11<sup>3</sup>/<sub>4</sub>"x23<sup>5</sup>/<sub>8</sub>" ≠ 9 mm Statuario Select / Crema Delicato / Grey Fleury



Statuario Select



Crema Delicato



Grey Fleury



# TECHNICAL SPECIFICATIONS

**TRIM TILES / PEZZI SPECIALI**

**± 20 mm**

			AIX	AXI	BLAZE	BOOST	BOOST PRO	BRAVE	DOLMEN PRO	DWELL	ETIC PRO	EXENCE	KLIF	KONE	LIMS	MARVEL STONE	NORDE	PRISM	RAW	TRUST
Lineare	30x60 cm	11 <sup>3</sup> / <sub>4</sub> "x23 <sup>5</sup> / <sub>8</sub> "	•	•	•	•	•	•					•	•	•	•	•	•	•	•
	33x120 cm	13"x47 <sup>1</sup> / <sub>4</sub> "	•		•	•	•	•	•						•	•	•	•	•	•
	30x120 cm	11 <sup>3</sup> / <sub>4</sub> "x47 <sup>1</sup> / <sub>4</sub> "									•	•								
Round	60x90 cm	23 <sup>5</sup> / <sub>8</sub> "x35 <sup>3</sup> / <sub>8</sub> "	•														•			
	45x90 cm	17 <sup>3</sup> / <sub>4</sub> "x35 <sup>3</sup> / <sub>8</sub> "		•		•	•	•		•			•							•
	40x80 cm	15 <sup>3</sup> / <sub>4</sub> "x31 <sup>1</sup> / <sub>2</sub> "															•	•		
Round Angolare Dx/Sx	30x60 cm	11 <sup>3</sup> / <sub>4</sub> "x23 <sup>5</sup> / <sub>8</sub> "	•	•	•	•	•	•					•	•	•	•	•	•	•	•
	33x120 cm	13"x47 <sup>1</sup> / <sub>4</sub> "	•		•	•	•	•	•						•	•	•	•	•	•
	30x120 cm	11 <sup>3</sup> / <sub>4</sub> "x47 <sup>1</sup> / <sub>4</sub> "									•	•								
	30x60 cm	11 <sup>3</sup> / <sub>4</sub> "x23 <sup>5</sup> / <sub>8</sub> "	•	•	•	•	•	•					•	•	•	•	•	•	•	•
	60x90 cm	23 <sup>5</sup> / <sub>8</sub> "x35 <sup>3</sup> / <sub>8</sub> "	•														•			
	40x80 cm	15 <sup>3</sup> / <sub>4</sub> "x31 <sup>1</sup> / <sub>2</sub> "															•	•		
Round	60x60 cm	23 <sup>5</sup> / <sub>8</sub> "x23 <sup>5</sup> / <sub>8</sub> "	•	•	•	•	•	•					•	•	•	•	•	•	•	•
Round Angolare	60x60 cm	23 <sup>5</sup> / <sub>8</sub> "x23 <sup>5</sup> / <sub>8</sub> "	•	•	•	•	•	•					•	•	•	•	•	•	•	•
Gradino Round	30x60 cm	11 <sup>3</sup> / <sub>4</sub> "x23 <sup>5</sup> / <sub>8</sub> "	•	•	•	•	•	•					•	•	•	•	•	•	•	•
Gradino Round Angolare Dx/Sx	30x60 cm	11 <sup>3</sup> / <sub>4</sub> "x23 <sup>5</sup> / <sub>8</sub> "	•	•	•	•	•	•					•	•	•	•	•	•	•	•
Elemento L	33x120 cm	13"x47 <sup>1</sup> / <sub>4</sub> "	•		•	•	•	•	•						•	•	•	•	•	•
	33x90 cm	13"x35 <sup>3</sup> / <sub>8</sub> "	•	•		•	•	•		•							•			•
	33x80 cm	13"x31 <sup>1</sup> / <sub>2</sub> "															•	•		
	20x60 cm	7 <sup>7</sup> / <sub>8</sub> "x23 <sup>5</sup> / <sub>8</sub> "	•	•	•	•	•	•	•				•	•	•	•	•	•	•	•
Elemento L Angolare	33x33 cm	13"x13"	•		•	•	•	•	•	•							•	•	•	•
	20x20 cm	7 <sup>7</sup> / <sub>8</sub> "x7 <sup>7</sup> / <sub>8</sub> "	•		•	•	•	•					•	•	•	•	•	•	•	•
Elemento L Angolare Dx/Sx	20x20 cm	7 <sup>7</sup> / <sub>8</sub> "x7 <sup>7</sup> / <sub>8</sub> "		•																
	33x33 cm	13"x13"		•																
Alzata	30x120 cm	11 <sup>3</sup> / <sub>4</sub> "x47 <sup>1</sup> / <sub>4</sub> "									•	•								
	20x120 cm	7 <sup>7</sup> / <sub>8</sub> "x47 <sup>1</sup> / <sub>4</sub> "	•		•	•	•	•	•								•	•	•	•
	20x90 cm	7 <sup>7</sup> / <sub>8</sub> "x35 <sup>3</sup> / <sub>8</sub> "	•	•		•	•	•	•	•							•			•
Top	30x120 cm	11 <sup>3</sup> / <sub>4</sub> "x47 <sup>1</sup> / <sub>4</sub> "	•		•	•	•	•	•		•	•					•	•	•	•
	30x60 cm	11 <sup>3</sup> / <sub>4</sub> "x23 <sup>5</sup> / <sub>8</sub> "	•	•	•	•	•	•	•				•	•	•	•	•	•	•	•
Costa Design	33x120 cm	13"x47 <sup>1</sup> / <sub>4</sub> "	•		•	•	•	•	•								•	•	•	•
Bordo Piscina	30x60 cm	11 <sup>3</sup> / <sub>4</sub> "x23 <sup>5</sup> / <sub>8</sub> "	•	•	•	•	•	•					•	•	•	•	•	•	•	•
Bordo Piscina Angolare Dx/Sx	30x60 cm	11 <sup>3</sup> / <sub>4</sub> "x23 <sup>5</sup> / <sub>8</sub> "	•	•	•	•	•	•					•	•	•	•	•	•	•	•
Griglia	20x60 cm	7 <sup>7</sup> / <sub>8</sub> "x23 <sup>5</sup> / <sub>8</sub> "	•	•	•	•	•	•					•	•	•	•	•	•	•	•
	15x60 cm	5 <sup>7</sup> / <sub>8</sub> "x23 <sup>5</sup> / <sub>8</sub> "	•	•		•	•	•					•	•	•	•	•	•	•	•
Griglia Angolare Dx/Sx	20x60 cm	7 <sup>7</sup> / <sub>8</sub> "x23 <sup>5</sup> / <sub>8</sub> "	•	•	•	•	•	•					•	•	•	•	•	•	•	•
	15x60 cm	5 <sup>7</sup> / <sub>8</sub> "x23 <sup>5</sup> / <sub>8</sub> "	•	•	•	•	•	•					•	•	•	•	•	•	•	•
Curve	60x60 cm	23 <sup>5</sup> / <sub>8</sub> "x23 <sup>5</sup> / <sub>8</sub> "	•	•	•	•	•	•					•	•	•	•	•	•	•	•
Smussato	30x60 cm	11 <sup>3</sup> / <sub>4</sub> "x23 <sup>5</sup> / <sub>8</sub> "	•	•	•	•	•	•					•	•	•	•	•	•	•	•

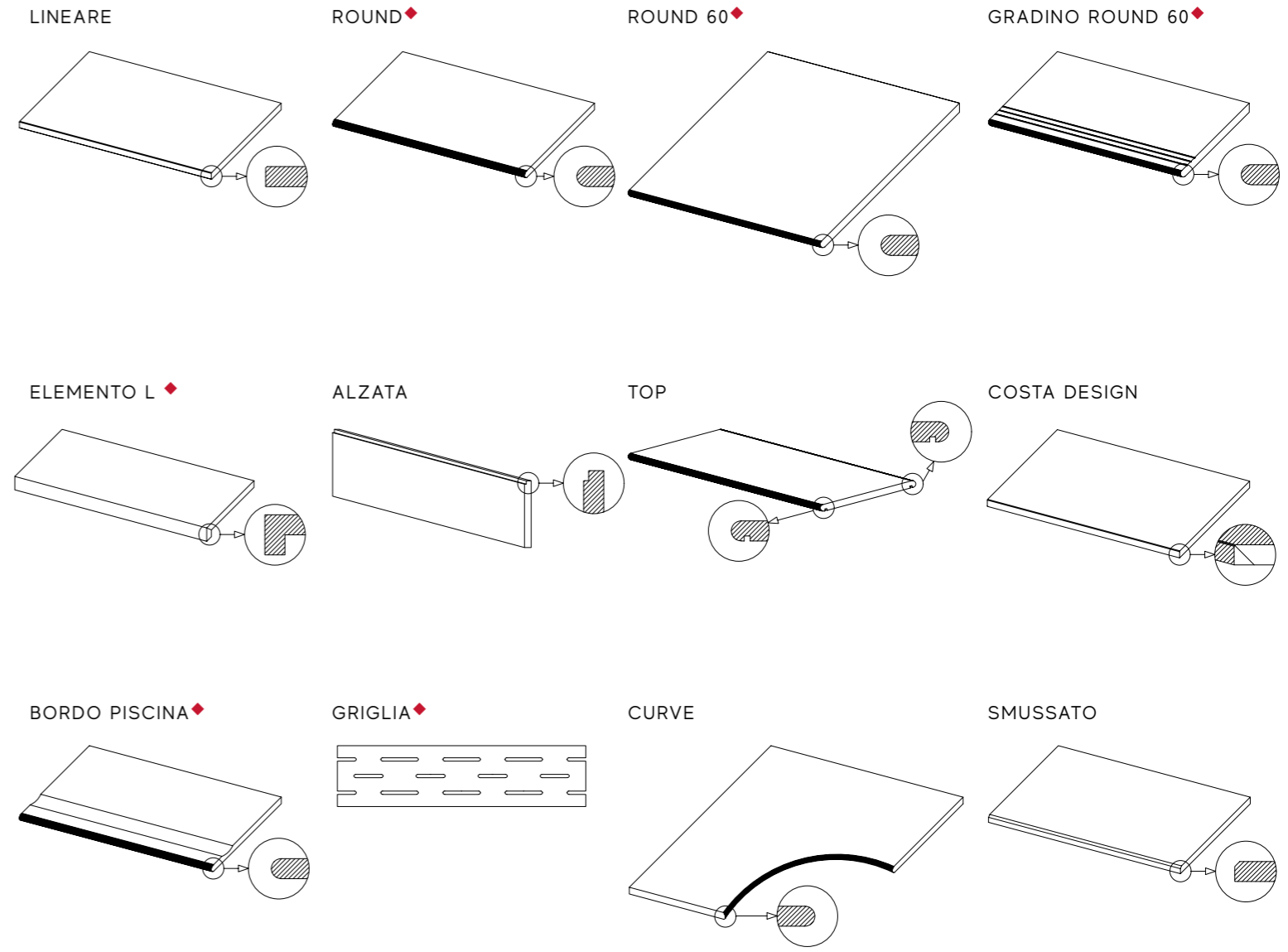

◆ Right/left angular elements are available / Sono disponibili gli elementi angolari dx/sx

**LASTRA STEPS**

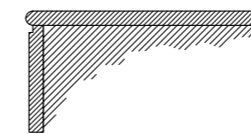

Round + Alzata

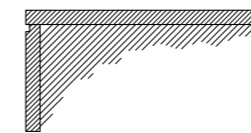

Lineare + Alzata

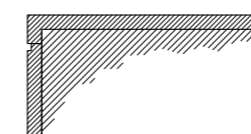

Elemento L + Alzata



AVAILABLE SIZES / FORMATI DISPONIBILI

INDOOR

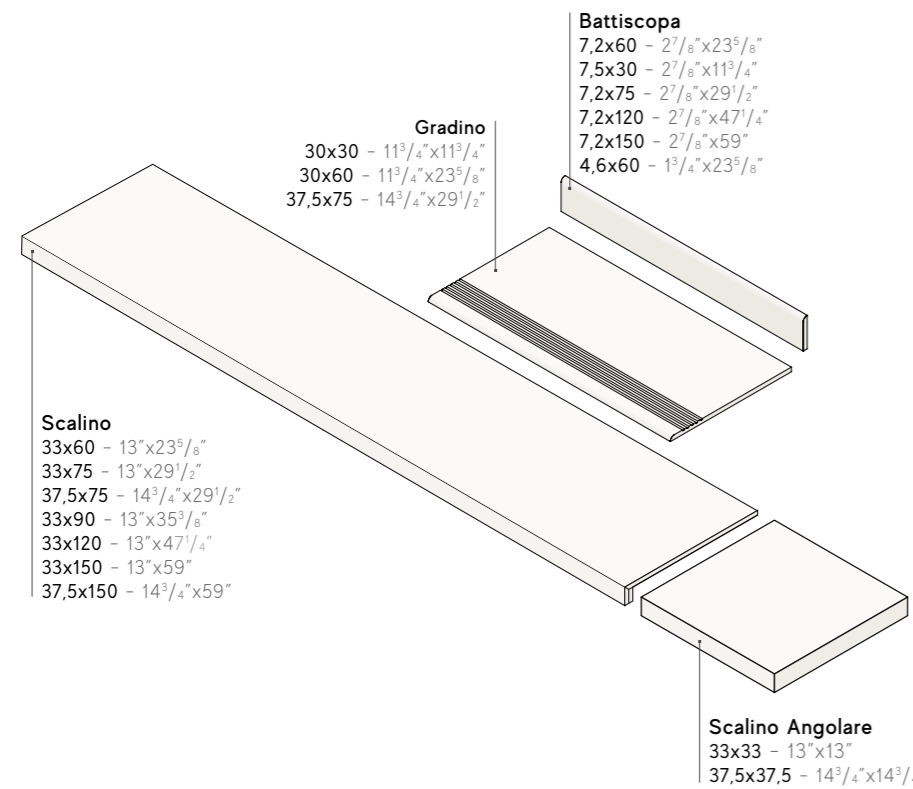

OUTDOOR

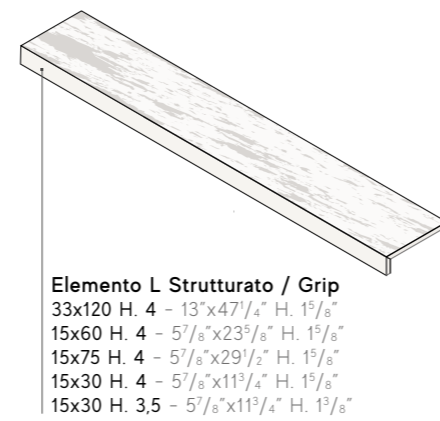

Battiscopa Sagomato

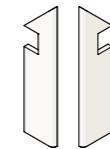

**Battiscopa Sag. Scala Dx / Sx**  
 7,5x30 - 3"x11<sup>3</sup>/<sub>4</sub>"  
 7,2x30 - 2<sup>7</sup>/<sub>8</sub>"x11<sup>3</sup>/<sub>4</sub>"

WOOD LOOK

INDOOR

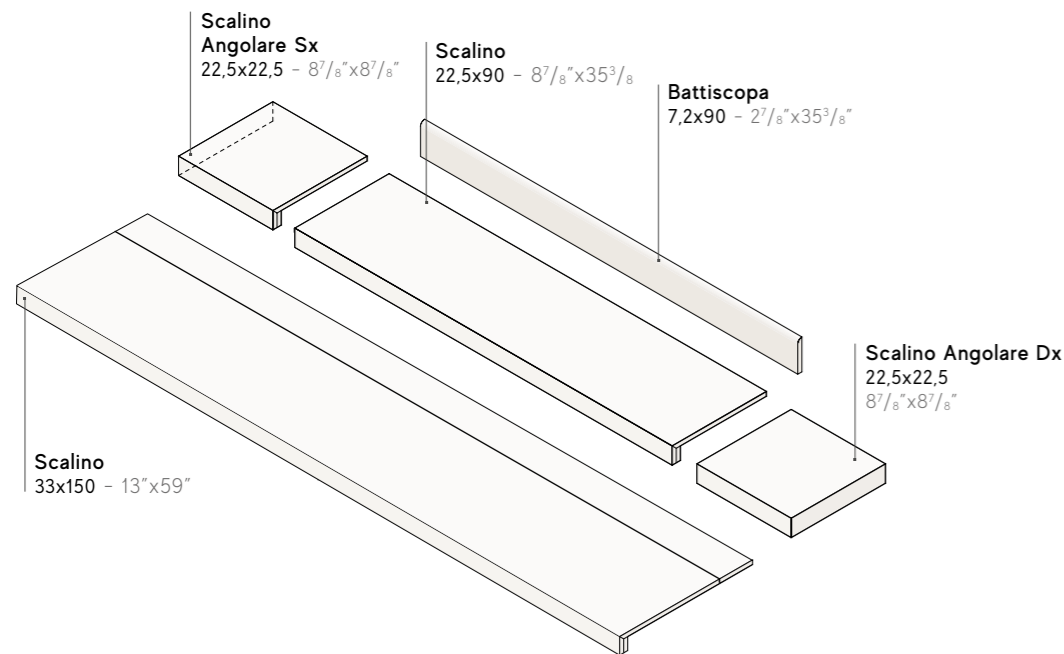

OUTDOOR

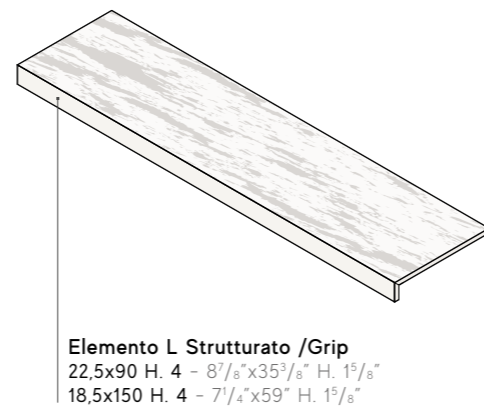

TECHNICAL SPECIFICATIONS / SPECIFICHE TECNICHE

GRADINO

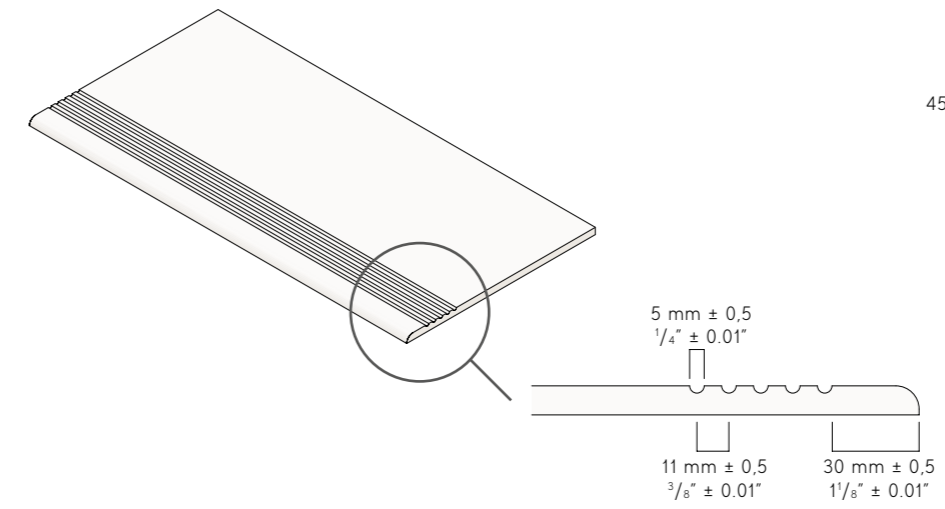

BATTISCOPA SAGOMATO

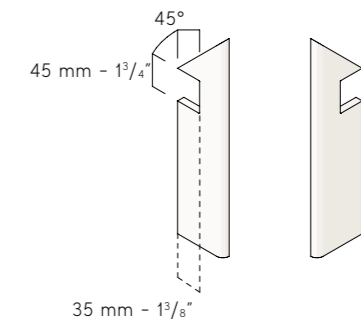

SCALINO

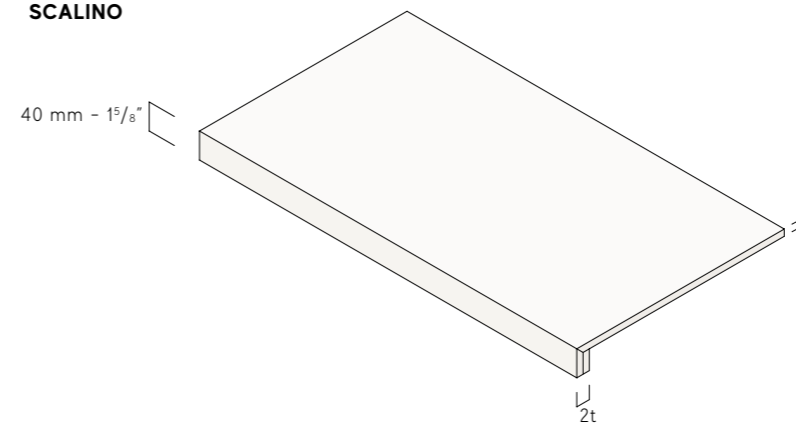

ELEMENTO L STRUTTURATO/GRIP

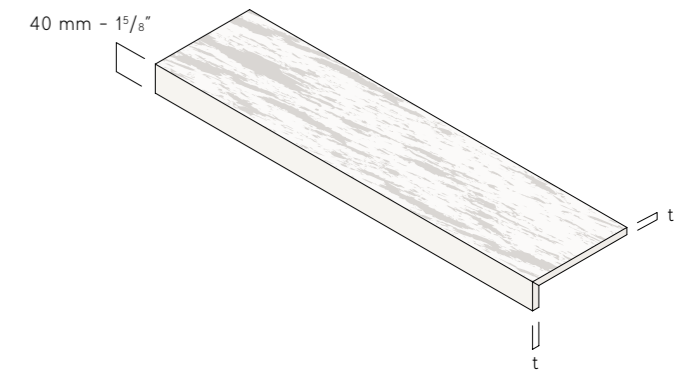

SCALINO ANGOLARE

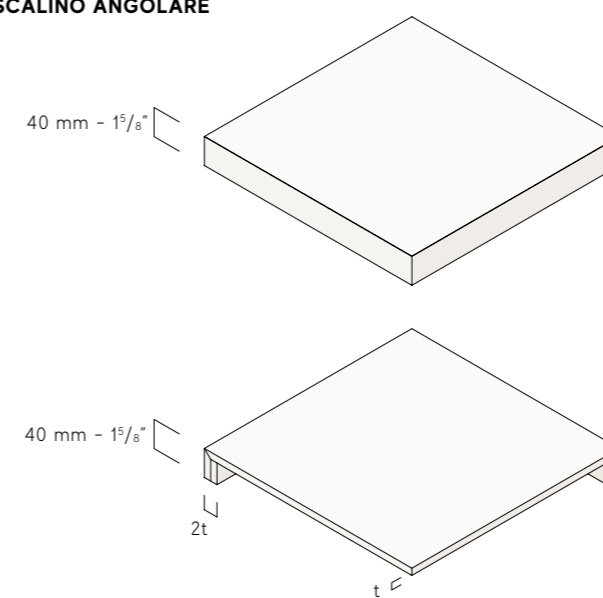

t = thickness



# RECOMMENDATIONS FOR RAISED INSTALLATION

RACCOMANDAZIONI PER LA POSA SOPRAELEVATA / EMPFEHLUNGEN FÜR DIE VERLEGUNG ALS DOPPELBODEN / CONSEILS POUR LA POSE SURÉLEVÉE / RECOMENDACIONES PARA LA COLOCACIÓN SOBREELEVADA / РЕКОМЕНДАЦИИ ПО УКЛАДКЕ В ВИДЕ ФАЛЬШПОЛА

## Size 60x60 – 20 mm / 30mm thickness

For the raised installation of 60x60 slabs in 20mm thickness a maximum raise of the foot plan of 10cm is recommended. It is possible to install 60x60 slabs in 20 mm thickness at a greater raise than 10 cm via the application of a double glass fibre net to the back of the tile, this allows for raises up to 30 cm.

## Sizes 45x90 – 60x90 – 80x80 – 90x90 – 30x120 – 40x120 – 60x120 – 120x120 – 120x240 – 20 mm thickness

The 45x90 – 60x90 – 80x80 – 90x90 – 30x120 – 40x120 – 60x120 – 120x120 – 120x240 sizes in 20 mm thickness are suitable for installation onto cement footing, gravel and/or supports with a maximum raise of 2 cm installing supports as indicated in the table in order to uniformly distribute the load on the surface. For raises between 2 and 30 cm, it is necessary to apply a double glass fibre net to the rear of the slab.

## Formato 60x60 – 20 mm / 30 mm di spessore

Per la posa delle lastre 60x60 in 20 mm di spessore, in applicazione sopraelevata, si raccomanda una sopraelevazione massima del piano di calpestio non superiore a 10 cm. È comunque possibile posare lastre di 60x60 in 20 mm di spessore ad altezze superiori ai 10 cm previa applicazione tramite incollaggio nella parte inferiore della lastra di una doppia rete in fibra di vetro per sopraelevazioni fino a 30 cm.

## Formati 45x90 – 60x90 – 80x80 – 90x90 – 30x120 – 40x120 – 60x120 – 120x120 – 120x240 – 20 mm di spessore

I formati 45x90 – 60x90 – 80x80 – 90x90 – 30x120 – 40x120 – 60x120 – 120x120 – 120x240 in 20 mm di spessore sono ritenuti idonei per la posa su massetto, su ghiaia o su supporti ad una altezza massima di 2cm disponendo i supporti come indicato nella tabella in modo da distribuire uniformemente i carichi. Per una sopraelevazione compresa tra i 2 ed i 30 cm è necessaria l'applicazione di una doppia rete in fibra di vetro nella parte inferiore della lastra.

## Format 60x60 – 20 mm / 30 mm Stärke

Für die Verlegung von 60x60 cm Platten in einer Stärke von 20 mm als Doppelboden empfehlen wir eine maximale Aufbauhöhe der Trittfäche nicht über 10 cm. Es ist jedoch möglich die 60x60 cm Platten in einer Stärke von 20 mm in einer Aufbauhöhe über 10 cm (bis zu 30 cm Aufbauhöhe) zu verlegen, dazu ist jedoch am unteren Teil der Platte ein Glasfasernetz anzukleben.

## FORMATE 45x90 – 60x90 – 80x80 – 90x90 – 30x120 – 40x120 – 60x120 – 120x120 – 120x240 – IN EINER STÄRKE VON 20 mm

Die Formate 45x90 – 60x90 – 80x80 – 90x90 – 30x120 – 40x120 – 60x120 – 120x120 – 120x240 in einer Stärke von 20 mm eignen sich für die Verlegung auf Estrich, Kies oder auf Träger mit einer maximalen Aufbauhöhe von 2 cm, dabei sind Träger wie in der Tabelle gezeigt zu verwenden, um die Lasten, die auf die Trittfäche wirken gleichmäßig zu verteilen. Für einen Doppelboden mit einer Aufbauhöhe zwischen 2 und 30 cm ist die Anbringung eines Doppelnetzes aus Glasfaser am unteren Teil der Platte notwendig.

SIZE	UP TO ¾" (2cm)	FROM ¾" (2cm) TO 4" (10cm)	FROM 4" (10cm) TO 12" (30cm)
FORMATO	FINO A 2 CM	DA 2 CM A 10 CM	DA 10 CM A 30 CM
FORMAT	BIS 2 CM	VON 2 BIS 10 CM	VON 10 BIS 30 CM
24"x24" 60x60cm (nominal) 4 supports per slab	4 supports (3,4 pcs/m <sup>2</sup> )	4 supports (3,4 pcs/m <sup>2</sup> )	4 supports double glass-fibre net (3,4 pcs/m <sup>2</sup> )
60x60 cm (nominale) 4 supporti per lastra	4 supporti (3,4 pz/m <sup>2</sup> )	4 supporti (3,4 pz/m <sup>2</sup> )	4 supporti + doppia rete in fibra di vetro (3,4 pz/m <sup>2</sup> )
60x60 cm (Nominalstärke) 4 Träger pro Platte	4 Träger (3,4 St/m <sup>2</sup> )	4 Träger (3,4 St/m <sup>2</sup> )	4 Träger + doppeltes Glasfasernetz (3,4 St/m <sup>2</sup> )
18"x36" 45x90cm (nominal) 6 supports per slab	6 supports (6,0 pcs/m <sup>2</sup> )	6 supports (6,0 pcs/m <sup>2</sup> ) double glass-fibre net	6 supports (6,0 pcs/m <sup>2</sup> ) double glass-fibre net
45x90 cm (nominale) 6 supporti per lastra	6 supporti (6,0 pz/m <sup>2</sup> )	6 supporti + doppia rete in fibra di vetro (6,0 pz/m <sup>2</sup> )	6 supporti + doppia rete in fibra di vetro (6,0 pz/m <sup>2</sup> )
45x90 cm (Nominalstärke) 6 Träger pro Platte	6 Träger (6,0 St/m <sup>2</sup> )	6 Träger + doppeltes Glasfasernetz (6,0 St/m <sup>2</sup> )	6 Träger + doppeltes Glasfasernetz (6,0 St/m <sup>2</sup> )
24"x36" 60x90cm (nominal) 6 supports per slab	6 supports (4,8 pcs/m <sup>2</sup> )	6 supports (4,8 pcs/m <sup>2</sup> ) double glass-fibre net	6 supports (4,8 pcs/m <sup>2</sup> ) double glass-fibre net
60x90 cm (nominale) 6 supporti per lastra	6 supporti (4,8 pz/m <sup>2</sup> )	6 supporti + doppia rete in fibra di vetro (4,8 pz/m <sup>2</sup> )	6 supporti + doppia rete in fibra di vetro (4,8 pz/m <sup>2</sup> )
60x90 cm (Nominalstärke) 6 Träger pro Platte	6 Träger (4,8 St/m <sup>2</sup> )	6 Träger + doppeltes Glasfasernetz (4,8 St/m <sup>2</sup> )	6 Träger + doppeltes Glasfasernetz (4,8 St/m <sup>2</sup> )
31"½"x31"½" 80x80 cm (nominal) 4 supports per slab	4 supports (2 pcs/m <sup>2</sup> )	4 supports double glass-fibre net (2 pcs/m <sup>2</sup> )	4 supports double glass-fibre net (2 pcs/m <sup>2</sup> )
80x80 cm (nominale) 4 supporti per lastra	4 supporti (2 pz/m <sup>2</sup> )	4 supporti + doppia rete in fibra di vetro (2 pz/m <sup>2</sup> )	4 supporti + doppia rete in fibra di vetro (2 pz/m <sup>2</sup> )
80x80 cm (Nominalstärke) 4 Träger pro Platte	4 Träger (2 St/m <sup>2</sup> )	4 Träger + doppeltes Glasfasernetz (2 St/m <sup>2</sup> )	4 Träger + doppeltes Glasfasernetz (2 St/m <sup>2</sup> )
36"x36" 90x90 cm (nominal) 4 supports per slab	4 supports (1,6 pcs/m <sup>2</sup> )	4 supports double glass-fibre net (1,6 pcs/m <sup>2</sup> )	4 supports double glass-fibre net (1,6 pcs/m <sup>2</sup> )
90x90 cm (nominale) 4 supporti per lastra	4 supporti (1,6 pz/m <sup>2</sup> )	4 supporti + doppia rete in fibra di vetro (1,6 pz/m <sup>2</sup> )	4 supporti + doppia rete in fibra di vetro (1,6 pz/m <sup>2</sup> )
90x90 cm (Nominalstärke) 4 Träger pro Platte	4 Träger (1,6 St/m <sup>2</sup> )	4 Träger + doppeltes Glasfasernetz (1,6 St/m <sup>2</sup> )	4 Träger + doppeltes Glasfasernetz (1,6 St/m <sup>2</sup> )
12"x48" 30x120 cm (nominal) 6 supports per slab	6 supports (7,0 pcs/m <sup>2</sup> )	6 supports double glass-fibre net (7,0 pcs/m <sup>2</sup> )	6 supports double glass-fibre net (7,0 pcs/m <sup>2</sup> )
30x120 cm (nominale) 6 supporti per lastra	6 supporti (7,0 pz/m <sup>2</sup> )	6 supporti + doppia rete in fibra di vetro (7,0 pz/m <sup>2</sup> )	6 supporti + doppia rete in fibra di vetro (7,0 pz/m <sup>2</sup> )
30x120 cm (Nominalstärke) 6 Träger pro Platte	6 Träger (7,0 St/m <sup>2</sup> )	6 Träger + doppeltes Glasfasernetz (7,0 St/m <sup>2</sup> )	6 Träger + doppeltes Glasfasernetz (7,0 St/m <sup>2</sup> )
16"x48" 40x120 cm (Nominal) 6 supports per slab	6 supports (5,4 pcs/m <sup>2</sup> )	6 supports double glass-fibre net (5,4 pcs/m <sup>2</sup> )	6 supports double glass-fibre net (5,4 pcs/m <sup>2</sup> )
40x120 cm (nominale) 6 supporti per lastra	6 supporti (5,4 pz/m <sup>2</sup> )	6 supporti + doppia rete in fibra di vetro (5,4 pz/m <sup>2</sup> )	6 supporti + doppia rete in fibra di vetro (5,4 pz/m <sup>2</sup> )
40x120 cm (Nominalstärke) 6 Träger pro Platte	6 Träger (5,4 St/m <sup>2</sup> )	6 Träger + doppeltes Glasfasernetz (5,4 St/m <sup>2</sup> )	6 Träger + doppeltes Glasfasernetz (5,4 St/m <sup>2</sup> )
24"x48" 60x120 cm (Nominal) 6 supports per slab	6 supports (3,4 pcs/m <sup>2</sup> )	6 supports double glass-fibre net (3,4 pcs/m <sup>2</sup> )	6 supports double glass-fibre net (3,4 pcs/m <sup>2</sup> )
60x120 cm (nominale) 6 supporti per lastra	6 supporti (3,4 pz/m <sup>2</sup> )	6 supporti + doppia rete in fibra di vetro (3,4 pz/m <sup>2</sup> )	6 supporti + doppia rete in fibra di vetro (3,4 pz/m <sup>2</sup> )
60x120 cm (Nominalstärke) 6 Träger pro Platte	6 Träger (3,4 St/m <sup>2</sup> )	6 Träger + doppeltes Glasfasernetz (3,4 St/m <sup>2</sup> )	6 Träger + doppeltes Glasfasernetz (3,4 St/m <sup>2</sup> )
48"x48" 120x120cm (Nominal) 8 supports per slab	8 supports (2,7 pcs/m <sup>2</sup> )	8 supports double glass-fibre net (2,7 pcs/m <sup>2</sup> )	8 supports double glass-fibre net (2,7 pcs/m <sup>2</sup> )
120x120 cm (nominale) 8 supporti per lastra	8 supporti (2,7 pz/m <sup>2</sup> )	8 supporti + doppia rete in fibra di vetro (2,7 pz/m <sup>2</sup> )	8 supporti + doppia rete in fibra di vetro (2,7 pz/m <sup>2</sup> )
120x120 cm (Nominalstärke) 8 Träger pro Platte	8 Träger (2,7 St/m <sup>2</sup> )	8 Träger + doppeltes Glasfasernetz (2,7 St/m <sup>2</sup> )	8 Träger + doppeltes Glasfasernetz (2,7 St/m <sup>2</sup> )
48"x95" - 120x240cm (Nominal) 15 supports per slab	15 supports (3,4 pcs/m <sup>2</sup> )	15 supports double glass-fibre net (3,4 pcs/m <sup>2</sup> )	15 supports double glass-fibre net (3,4 pcs/m <sup>2</sup> )
120x240 cm - (nominale) 15 supporti per lastra	15 supporti (3,4 pz/m <sup>2</sup> )	15 supporti + doppia rete in fibra di vetro (3,4 pz/m <sup>2</sup> )	15 supporti + doppia rete in fibra di vetro (3,4 pz/m <sup>2</sup> )
120x240 cm (Nominalstärke) 15 Träger pro Platte	15 Träger (3,4 St/m <sup>2</sup> )	15 Träger + doppeltes Glasfasernetz (3,4 St/m <sup>2</sup> )	15 Träger + doppeltes Glasfasernetz (3,4 St/m <sup>2</sup> )

## Format 60x60 – 20 mm / 30 mm d'épaisseur

Pour la pose des dalles 60x60 en 20 mm d'épaisseur, avec application surélevée, nous préconisons une surélévation du plan de piétinement inférieure à 10 cm maximum. Il est toutefois possible de poser des dalles au format 60x60 en 20 mm d'épaisseur à des hauteurs supérieures à 10 cm, à condition d'appliquer par collage, dans la partie inférieure de la dalle, un double treillis en fibre de verre ou pour des surélévations jusqu'à 30 cm.

## Formats 45x90 – 60x90 – 80x80 – 90x90 – 30x120 – 40x120 – 60x120 – 120x120 – 120x240 – 20mm d'épaisseur

Les formats 45x90 – 60x90 – 80x80 – 90x90 – 30x120 – 40x120 – 60x120 – 120x120 – 120x240 en 20 mm d'épaisseur sont adaptés à la pose sur chape, gravie ou sur supports d'une hauteur maximum de 2 cm en employant les supports comme indiqué dans la table de manière à distribuer uniformément les charges. Pour une surélévation comprise entre 2 et 30 cm il est nécessaire d'appliquer un double treillis en fibre de verre sous la dalle.

## Formato 60x60 – 20 mm / 30 mm de espesor

Para la colocación de las losas de 60x60 de 20 mm de espesor, en aplicación flotante, se recomienda una sobre elevación del plano transitable que no supere los 10 cm. De todas maneras es posible colocar las losas de 60x60 de 20 mm de espesor a alturas superiores a los 10 cm previa aplicación mediante adhesivo en el revés de la losa de una doble red de fibra de vidrio para sobre elevaciones de hasta los 30 cm.

## Formatos 45x90 – 60x90 – 80x80 – 90x90 – 30x120 – 40x120 – 60x120 – 120x120 – 120x240 – 20mm de espesor

Los formatos 45x90 – 60x90 – 80x80 – 90x90 – 30x120 – 40x120 – 60x120 – 120x120 – 120x240 en 20 mm de espesor son considerados idóneos para la colocación sobre contrapiso, sobre grava o sobre pedestales de una altura máxima de 2 cm utilizando pedestales como indicado en la tabla en modo de distribuir las cargas de manera uniforme. Para una elevación comprendida entre los 2 y los 30 cm es necesaria la aplicación de una doble red en fibra de vidrio por el revés de la losa.

## Формат 60x60 толщиной 20 / 30 мм

При укладке плиток 60x60 толщиной 20 мм в виде фальшпола рекомендуется устанавливать их на высоту не более 10 см. Тем не менее возможна укладка плиток 60x60 толщиной 20 мм и на высоту более 10 см. В этом случае на тыльную сторону плиток необходимо наклеить двойную стекловолоконную сетку (при монтаже на высоту до 30 см).

## ФОРМАТЫ 45x90 – 60x90 – 80x80 – 90x90 – 30x120 – 40x120 – 60x120 – 120x120 – 120x240 – ТОЛЩИНОЙ 20 мм

Форматы 45x90 – 60x90 – 80x80 – 90x90 – 30x120 – 40x120 – 60x120 – 120x120 – 120x240 толщиной 20 мм подходят для укладки на стяжку, гравий или на опоры высотой не более 2 см с использованием опор, как указано в таблице на каждую плитку для равномерного распределения нагрузок. При монтаже на высоту от 2 до 30 см на тыльную сторону плиток необходимо наклеить двойную стекловолоконную сетку.

FORMAT	JUSQU'À 2 CM	DE 2 À 10 CM	DE 10 À 30 CM
FORMATO	HASTA 2 CM	DA 2 CM A 10 CM	DA 10 CM A 30 CM
ФОРМАТ	ДО 2 CM	2-10 CM	10-30 CM
60x60 cm (Nominal) 4 supports par plaque	4 supports (3,4 pc/m <sup>2</sup> )	4 supports (3,4 pc/m <sup>2</sup> )	4 supports + double treillis fibre de verre (3,4 pc/m <sup>2</sup> )
60x60 cm (Nominal) 4 pedestales por losa	4 pedestales (3,4 pz/m <sup>2</sup> )	4 pedestales (3,4 pz/m <sup>2</sup> )	4 pedestales + doble red de fibra de vidrio (3,4 pz/m <sup>2</sup> )
60x60 cm (номинальный) 4 опоры на каждую плитку	4 опор (3,4 шт./м <sup>2</sup> )	4 опор (3,4 шт./м <sup>2</sup> )	4 опор + двойная стекловолоконная сетка (3,4 шт./м <sup>2</sup> )
45x90 cm (Nominal) 6 supports par plaque	6 supports (6,0 pcs/m <sup>2</sup> )	6 supports + double treillis fibre de verre (6,0 pz/m <sup>2</sup> )	6 supports + double treillis fibre de verre (6,0 pc/m <sup>2</sup> )
45x90 cm (Nominal) 6 pedestales por losa	6 pedestales (6,0 pz/m <sup>2</sup> )	6 pedestales + doble red de fibra de vidrio (6,0 pz/m <sup>2</sup> )	6 pedestales + doble red de fibra de vidrio (6,0 pz/m <sup>2</sup> )
45x90 cm (номинальный) 6 опор на каждую плитку	6 опор (6,0 шт./м <sup>2</sup> )	6 опор + двойная стекловолоконная сетка (6,0 шт./м <sup>2</sup> )	6 опор + двойная стекловолоконная сетка (6,0 шт./м <sup>2</sup> )
60x90 cm (Nominal) 6 supports par plaque	6 supports (4,8 pcs/m <sup>2</sup> )	6 supports + double treillis fibre de verre (4,8 pz/m <sup>2</sup> )	6 supports + double treillis fibre de verre (4,8 pc/m <sup>2</sup> )
60x90 cm (Nominal) 6 pedestales por losa	6 pedestales (4,8 pz/m <sup>2</sup> )	6 pedestales + doble red de fibra de vidrio (4,8 pz/m <sup>2</sup> )	6 pedestales + doble red de fibra de vidrio (4,8 pz/m <sup>2</sup> )
60x90 cm (номинальный) 6 опор на каждую плитку	6 опор (4,8 шт./м <sup>2</sup> )	6 опор + двойная стекловолоконная сетка (4,8 шт./м <sup>2</sup> )	6 опор + двойная стекловолоконная сетка (4,8 шт./м <sup>2</sup> )
80x80 cm (Nominal) 4 supports par plaque	4 supports (2 pcs/m <sup>2</sup> )	4 supports + double treillis fibre de verre (2 pz/m <sup>2</sup> )	4 supports + double treillis fibre de verre (2 pz/m <sup>2</sup> )
80x80 cm (Nominal) 4 pedestales por losa	4 pedestales (2 pz/m <sup>2</sup> )	4 pedestales + doble red de fibra de vidrio (2 pz/m <sup>2</sup> )	4 pedestales + doble red de fibra de vidrio (2 pz/m <sup>2</sup> )
80x80 cm (номинальный) 4 опор на каждую плитку	4 опор (2 шт./м <sup>2</sup> )	4 опор + двойная стекловолоконная сетка (2 шт./м <sup>2</sup> )	4 опор + двойная стекловолоконная сетка (2 шт./м <sup>2</sup> )
90x90 cm (Nominal) 4 supports par plaque	4 supports (1,6 pcs/m <sup>2</sup> )	4 supports + double treillis fibre de verre (1,6 pz/m <sup>2</sup> )	4 supports + double treillis fibre de verre (1,6 pc/m <sup>2</sup> )
90x90 cm (Nominal) 4 pedestales por losa	4 pedestales (1,6 pz/m <sup>2</sup> )	4 pedestales + doble red de fibra de vidrio (1,6 pz/m <sup>2</sup> )	4 pedestales + doble red de fibra de vidrio (1,6 pz/m <sup>2</sup> )
90x90 cm (номинальный) 4 опор на каждую плитку	4 опор (1,6 шт./м <sup>2</sup> )	4 опор + двойная стекловолоконная сетка (1,6 шт./м <sup>2</sup> )	4 опор + двойная стекловолоконная сетка (1,6 шт./м <sup>2</sup> )
30x120 cm (Nominal) 6 supports par plaque	6 supports (7,0 pc/m <sup>2</sup> )	6 supports + double treillis fibre de verre (7,0 pz/m <sup>2</sup> )	6 supports + double treillis fibre de verre (7,0 pc/m <sup>2</sup> )
30x120 cm (Nominal) 6 pedestales por losa	6 pedestales (7,0 pz/m <sup>2</sup> )	6 pedestales + doble red de fibra de vidrio (7,0 pz/m <sup>2</sup> )	6 pedestales + doble red de fibra de vidrio (7,0 pz/m <sup>2</sup> )
30x120 cm (номинальный) 6 опор на каждую плитку	6 опор (7,0 шт./м <sup>2</sup> )	6 опор + двойная стекловолоконная сетка (7,0 шт./м <sup>2</sup> )	6 опор + двойная стекловолоконная сетка (7,0 шт./м <sup>2</sup> )
40x120 cm (nominal) 6 supports par plaque	6 supports (5,4 pc/m <sup>2</sup> )	6 supports + double treillis fibre de verre (5,4 pz/m <sup>2</sup> )	6 supports + double treillis fibre de verre (5,4 pc/m <sup>2</sup> )
40x120 cm (nominal) 6 pedestales por losa	6 pedestales (5,4 pz/m <sup>2</sup> )	6 pedestales + doble red de fibra de vidrio (5,4 pz/m <sup>2</sup> )	6 pedestales + doble red de fibra de vidrio (5,4 pz/m <sup>2</sup> )
40x120 cm (номинальный) 6 опор на каждую плитку	6 опор (5,4 шт./м <sup>2</sup> )	6 опор + двойная стекловолоконная сетка (5,4 шт./м <sup>2</sup> )	6 опор + двойная стекловолоконная сетка (5,4 шт./м <sup>2</sup> )
60x120 (nominal) 6 supports par plaque	6 supports (3,4 pcs/m <sup>2</sup> )	6 supports + double treillis fibre de verre (3,4 pcs/m <sup>2</sup> )	6 supports + double treillis fibre de verre (3,4 pcs/m <sup>2</sup> )
60x120 cm (nominal) 6 pedestales por losa	6 pedestales (3,4 pcs/m <sup>2</sup> )	6 pedestales + doble red de fibra de vidrio (3,4 pcs/m <sup>2</sup> )	6 pedestales + doble red de fibra de vidrio (3,4 pcs/m <sup>2</sup> )
60x120 cm (номинальный) 6 опор на каждую плитку	6 опор (3,4 шт./м <sup>2</sup> )	6 опор + двойная стекловолоконная сетка (3,4 шт./м <sup>2</sup> )	6 опор + двойная стекловолоконная сетка (3,4 шт./м <sup>2</sup> )
120x120 (nominal) 9 supports par plaque	8 supports (2,7 pcs/m <sup>2</sup> )	8 supports + double treillis fibre de verre (2,7 pcs/m <sup>2</sup> )	8 supports + double treillis fibre de verre (2,7 pcs/m <sup>2</sup> )
120x120 cm (nominal) 9 pedestales por losa	8 pedestales (2,7 pcs/m <sup>2</sup> )	8 pedestales + doble red de fibra de vidrio (2,7 pcs/m <sup>2</sup> )	8 pedestales + doble red de fibra de vidrio (2,7 pcs/m <sup>2</sup> )
120x120 cm (номинальный) 9 опор на каждую плитку	8 опор (2,7 шт./м <sup>2</sup> )	8 опор + двойная стекловолоконная сетка (2,7 шт./м <sup>2</sup> )	8 опор + двойная стекловолоконная сетка (2,7 шт./м <sup>2</sup> )
120x240 (nominal) 15 supports par plaque	15 supports (3,4 pcs/m <sup>2</sup> )	15 supports + double treillis fibre de verre (3,4 pcs/m <sup>2</sup> )	15 supports + double treillis fibre de verre (3,4 pcs/m <sup>2</sup> )
120x240 cm (nominal) 15 pedestales por losa	15 pedestales (3,4 pcs/m <sup>2</sup> )	15 pedestales + doble red de fibra de vidrio (3,4 pcs/m <sup>2</sup> )	15 pedestales + doble red de fibra de vidrio (3,4 pcs/m <sup>2</sup> )
120x240 cm (номинальный) 15 опор на каждую плитку	15 опор (3,4 шт./м <sup>2</sup> )	15 опор + двойная стекловолоконная сетка (3,4 шт./м <sup>2</sup> )	15 опор + двойная стекловолоконная сетка (3,4 шт./м <sup>2</sup> )

# RECOMMENDATIONS FOR RAISED INSTALLATION NORTH AMERICA AND OCEANIA MARKET SPECIFICATION

RACCOMANDAZIONI PER LA POSA SOPRAELEVATA / EMPFEHLUNGEN FÜR DIE VERLEGUNG ALS DOPPELBODEN / CONSEILS POUR LA POSE SURÉLEVÉE / RECOMENDACIONES PARA LA COLOCACIÓN SOBREELEVADA / РЕКОМЕНДАЦИИ ПО УКЛАДКЕ В ВИДЕ ФАЛЬШПОЛА

## NORTH AMERICA AND OCEANIA MARKET SPECIFICATION

Size 23<sup>5/8</sup>"x23<sup>5/8</sup>" - 60x60 cm in 3/4" - 20 mm thickness

For the raised installation of 23<sup>5/8</sup>"x23<sup>5/8</sup>" - 60x60 slabs in 3/4" - 20mm thickness, a maximum raise of the foot plan of 3/4" - 2 cm is recommended.

Sizes 17<sup>3/4</sup>"x35<sup>3/8</sup>" - 45x90, 23<sup>5/8</sup>"x35<sup>3/8</sup>" - 60x90, 31<sup>1/2</sup>"x31<sup>1/2</sup>" - 80x80, 36"x36" - 90x90, 11<sup>3/4</sup>"x47<sup>1/4</sup>" - 30x120, 15<sup>3/8</sup>"x 47<sup>1/4</sup>" - 40x120, 23<sup>5/8</sup>"x47<sup>1/4</sup>" - 60x120 in 3/4", 48"x48" - 120x120, 47<sup>1/4</sup>"x94<sup>1/2</sup>" - 120x240 - 20 mm thickness

The 17<sup>3/4</sup>"x35<sup>3/8</sup>" - 45x90, 31<sup>1/2</sup>"x31<sup>1/2</sup>" - 80x80, 36"x36" - 90x90, 11<sup>3/4</sup>"x47<sup>1/8</sup>" - 30x120, 15<sup>3/8</sup>"x 47<sup>1/4</sup>" - 40x120 and 23<sup>5/8</sup>"x47<sup>1/4</sup>" - 60x120 cm, 48"x48" - 120x120, 47<sup>1/4</sup>"x94<sup>1/2</sup>" - 120x240 sizes in 3/4" - 20mm thickness are suitable for installation onto footing, gravel, sand, grass or onto supports at a maximum raised of 3/4" - 2cm and using 6 supports per slab in order to uniformly distribute the load.

## SPECIFICHE PER I MERCATI NORD AMERICA E OCEANIA

Formato 60x60 cm - 20 mm di Spessore

Per la posa delle lastre 60x60 in 20mm di spessore, in applicazione sopraelevata, si raccomanda una sopraelevazione massima del piano di calpestio non superiore a 2cm.

Formati 45x90-60x90-80x80-90x90-30x120-40x120-60x120-120x120-120x240 - 20 mm di Spessore

I formati 45x90, 60x90, 80x80, 90x90, 30x120, 40x120, 60x120, 120x120, 120x240 in 20mm di spessore sono ritenuti idonei per la posa su massetto, su ghiaia, su sabbia, su erba o su supporti ad una altezza massima di 2cm utilizzando 6 supporti per lastra in modo da distribuire uniformemente i carichi.

## EMPFEHLUNGEN FÜR DIE VERLEGUNG VON LASTRA 20MM ALS DOPPELBODEN

Format 60x60 cm - 20 mm Stärke

Für die Verlegung von Lastra als Doppelboden im Format 60x60 - 20mm Stärke wird eine Aufbauhöhe von maximal 2cm empfohlen.

Formate 45x90-60x90-80x80-90x90-30x120-40x120-60x120-120x120-120x240 - 20 mm Stärke

Die Formate 45x90, 60x90, 80x80, 90x90, 30x120, 40x120, 60x120, 120x120, 120x240 in einer Stärke von 20 mm eignen sich für eine Verlegung auf Estrich, Kies, Sand und Rasen oder auf Träger mit einer maximalen Aufbauhöhe der Trittfäche von 2 cm unter Verwendung von 6 Träger pro Platte, um die Last gleichmäßig zu verteilen.

SIZE	UP TO 3/4" (2cm)	ABOVE 3/4" (2cm)
FORMATO	FINO A 2 CM 3/4	OLTRE AI 2CM 3/4
FORMAT	BIS 2 CM	ÜBER 2 CM
24"x24" 60x60 cm (nominal) 4 supports per slab		4 supports (0,32 pcs/sq ft) please contact your Atlas Concorde sales representative
60x60 cm (nominal) 4 supporti per lastra		4 supporti (0,32 pz/m²) contattare il referente commerciale Atlas Concorde
60x60 cm (Nominalstärke) 4 Träger pro Platte		4 Träger (0,32 St/m²) bitte kontaktieren sie den handelsvertreter von Atlas Concorde
18"x36" 45x90cm (nominal) 6 supports per slab		6 supports (0,56 pcs/sq ft) please contact your Atlas Concorde sales representative
45x90 cm (nominal) 6 supporti per lastra		6 supporti (0,56 pz/m²) contattare il referente commerciale Atlas Concorde
45x90 cm (Nominalstärke) 6 Träger pro Platte		6 Träger (0,56 St/m²) bitte kontaktieren sie den handelsvertreter von Atlas Concorde
24"x36" 60x90cm (nominal) 6 supports per slab		6 supports (0,48 pcs/sq ft) please contact your Atlas Concorde sales representative
60x90 cm (nominal) 6 supporti per lastra		6 supporti (0,48 pz/m²) contattare il referente commerciale Atlas Concorde
60x90 cm (Nominalstärke) 6 Träger pro Platte		6 Träger (0,48 St/m²) bitte kontaktieren sie den handelsvertreter von Atlas Concorde
31 1/2"x31 1/2" 80x80 cm (nominal) 4 supports per slab		4 supports (0,2 pcs/sq ft) please contact your Atlas Concorde sales representative
80x80 cm (nominal) 4 supporti per lastra		4 supporti (0,2 pz/m²) contattare il referente commerciale Atlas Concorde
80x80 cm (Nominalstärke) 4 Träger pro Platte		4 Träger (0,2 St/m²) bitte kontaktieren sie den handelsvertreter von Atlas Concorde
36"x36" 90x90cm (nominal) 4 supports per slab		4 supports (0,16 pcs/sq ft) please contact your Atlas Concorde sales representative
90x90 cm (nominal) 4 supporti per lastra		4 supporti (0,16 pz/m²) contattare il referente commerciale Atlas Concorde
90x90 cm (Nominalstärke) 4 Träger pro Platte		4 Träger (0,16 St/m²) bitte kontaktieren sie den handelsvertreter von Atlas Concorde
12"x48" 30x120cm (nominal) 6 supports per slab		6 supports (0,65 pcs/sq ft) please contact your Atlas Concorde sales representative
30x120 cm (nominal) 6 supporti per lastra		6 supporti (0,65 pz/m²) contattare il referente commerciale Atlas Concorde
30x120 cm (Nominalstärke) 6 Träger pro Platte		6 Träger (0,65 St/m²) bitte kontaktieren sie den handelsvertreter von Atlas Concorde
16"x48" 40x120cm (Nominal) 6 supports per slab		6 supports (0,54 pcs/sq ft) please contact your Atlas Concorde sales representative
40x120 cm (nominal) 6 supporti per lastra		6 supporti (0,54 pz/m²) contattare il referente commerciale Atlas Concorde
40x120 cm (Nominalstärke) 6 Träger pro Platte		6 Träger (0,54 St/m²) bitte kontaktieren sie den handelsvertreter von Atlas Concorde
24"x48" 60x120cm (Nominal) 6 supports per slab		6 supports (0,32 pcs/sq ft) please contact your Atlas Concorde sales representative
60x120 cm (nominal) 6 supporti per lastra		6 supporti (0,32 pz/m²) contattare il referente commerciale Atlas Concorde
60x120 cm (Nominalstärke) 6 Träger pro Platte		6 Träger (0,32 St/m²) bitte kontaktieren sie den handelsvertreter von Atlas Concorde
48"x48" 120x120cm (nominal) 8 supports per slab		8 supports (0,27 pcs/sq ft) please contact your Atlas Concorde sales representative
120x120 cm (nominal) 8 supporti per lastra		8 supporti (0,27 pz/m²) contattare il referente commerciale Atlas Concorde
120x120 cm (nominal) 8 Träger pro Platte		8 Träger (0,27 St/m²) bitte kontaktieren sie den handelsvertreter von Atlas Concorde
48"x95" - 120x240cm (Nominal) 15 supports per slab		15 supports (3,4 pcs/sq ft) please contact your Atlas Concorde sales representative
120x240 cm - (nominal) 15 supporti per lastra		15 supporti (3,4 pz/m²) contattare il referente commerciale Atlas Concorde
120x240 cm (Nominalstärke) 15 Träger pro Platte		15 Träger (3,4 St/m²) bitte kontaktieren sie den handelsvertreter von Atlas Concorde

SIZE	JUSQU'À 2 CM - 3/4" AU-DELÀ DE 2 CM - 3/4"	
FORMATO	HASTA 2 CM - 3/4" MÁS DE 2 CM - 3/4"	
ФОРМАТ	ДО 2 CM БОЛЕЕ 2 CM	
60x60 cm (nominal) 4 support par plaque		4 support (0,32 pcs/m²) contacter le représentant d'Atlas Concorde
60x60 cm (nominal) 4 pedestales por losa		4 pedestales (0,32 pzas/m²) ponerse en contacto con el agente de Atlas Concorde
60x60 cm (номинальный) 4 опоры на каждую плитку		4 опор (0,32 шт./м²) обратитесь к представителю Atlas Concorde
45x90 cm (nominal) 6 support par plaque		6 support (0,56 pcs/m²) contacter le représentant d'Atlas Concorde
45x90 cm (nominal) 6 pedestales por losa		6 pedestales (0,56 pzas/m²) ponerse en contacto con el agente de Atlas Concorde
45x90 cm (номинальный) 6 опор на каждую плитку		6 опор (0,56 шт./м²) обратитесь к представителю Atlas Concorde
60x90 cm (Nominal) 6 supports par plaque		6 supports (0,48 pcs/m²) contacter le représentant d'Atlas Concorde
60x90 cm (Nominal) 6 pedestales por losa		6 pedestales (0,48 pzas/m²) ponerse en contacto con el agente de Atlas Concorde
60x90 cm (номинальный) 6 опор на каждую плитку		6 опор (0,48 шт./м²) обратитесь к представителю Atlas Concorde
80x80 cm (nominal) 4 support par plaque		4 support (0,2 pcs/m²) contacter le représentant d'Atlas Concorde
80x80 cm (nominal) 4 supporti per lastra		4 pedestales (0,2 pzas/m²) ponerse en contacto con el agente de Atlas Concorde
80x80 cm (номинальный) 4 опор на каждую плитку		4 опор (0,2 шт./м²) обратитесь к представителю Atlas Concorde
90x90cm (nominal) 4 support par plaque		4 support (0,16 pcs/m²) contacter le représentant d'Atlas Concorde
90x90 cm (nominal) 4 pedestales por losa		4 pedestales (0,16 pzas/m²) ponerse en contacto con el agente de Atlas Concorde
90x90 cm (номинальный) 4 опор на каждую плитку		4 опор (0,16 шт./м²) обратитесь к представителю Atlas Concorde
30x120 cm (nominal) 6 support par plaque		6 support (0,65 pcs/m²) contacter le représentant d'Atlas Concorde
30x120 cm (nominal) 6 pedestales por losa		6 pedestales (0,65 pzas/m²) ponerse en contacto con el agente de Atlas Concorde
30x120 cm (номинальный) 6 опор на каждую плитку		6 опор (0,65 шт./м²) обратитесь к представителю Atlas Concorde
40x120 cm (nominal) 6 support par plaque		6 support (0,42 pcs/m²) contacter le représentant d'Atlas Concorde
40x120 cm (nominal) 6 pedestales por losa		6 pedestales (0,42 pzas/m²) ponerse en contacto con el agente de Atlas Concorde
40x120 cm (номинальный) 6 опор на каждую плитку		6 опор (0,42 шт./м²) обратитесь к представителю Atlas Concorde
60x120 cm (nominal) 6 support par plaque		6 support (0,32 pcs/m²) contacter le représentant d'Atlas Concorde
60x120 cm (nominal) 6 pedestales por losa		6 pedestales (0,32 pzas/m²) ponerse en contacto con el agente de Atlas Concorde
60x120 cm (номинальный) 6 опор на каждую плитку		6 опор (0,32 шт./м²) обратитесь к представителю Atlas Concorde
120x120 cm (nominal) 8 support par plaque		8 support (0,27 pcs/m²) contacter le représentant d'Atlas Concorde
120x120 cm (nominal) 8 pedestales por losa		8 pedestales (0,27 pzas/m²) ponerse en contacto con el agente de Atlas Concorde
120x120 cm (номинальный) 8 опор на каждую плитку		8 опор (0,27 шт./м²) обратитесь к представителю Atlas Concorde
120x240 (nominal) 15 supports par plaque		15 supports (3,4 pcs/m²) contacter le représentant d'Atlas Concorde
120x240 cm (nominal) 15 pedestales por losa		15 pedestales (3,4 pzas/m²) ponerse en contacto con el agente de Atlas Concorde
120x240 cm (номинальный) 15 опор на каждую плитку		15 опор (3,4 шт./м²) обратитесь к представителю Atlas Concorde

## INDICATIONS POUR LE MARCHÉ DE L'AMÉRIQUE DU NORD ET OCÉANIE

Format 60x60 cm en 20 mm d'épaisseur

Pour la pose surélevée des dalles au format 60x60 - 20 mm d'épaisseur, nous conseillons une hauteur maximale du plan de plancher de 2 cm.

Format 45x90-60x90-80x80-90x90-30x120-40x120-60x120-120x120-120x240 en 20 mm d'épaisseur

Les formats 45x90, 60x90, 80x80, 90x90, 30x120, 40x120, 60x120, 120x120, 120x240 20 mm d'épaisseur sont adapte à la pose sur chape, gravier, sable et gazon ou sur des pieds à une hauteur maximale du plancher de 2 cm et en utilisant 6 pieds par dalle de façon à distribuer uniformément la charge.

## ESPECIFICACIONES PARA EL MERCADO DE NORTEAMÉRICA Y OCEANÍA

Formato 60x60 cm en 20 mm de espesor

Para la colocación sobreelevada de losas de formato 60x60 - 20 mm de espesor, se recomienda que el plano transitable esté a una altura máxima de - 2 cm.

Formatos 45x90-60x90-80x80-90x90-30x120-40x120-60x120-120x120-120x240 - 20 mm de espesor

Los formatos 45x90, 60x90, 80x80, 90x90, 30x120, 40x120, 60x120, 120x120, 120x240 en 20 mm de espesor son adecuados para ser colocado sobre contrapiso, grava, arena y césped o sobre apoyos a una altura máxima del plano transitable de 2 cm y empleando 6 pedestales por losa en modo de distribuir uniformemente la carga.

## РЕКОМЕНДАЦИИ ПО УКЛАДКЕ ПЛИТОК LASTRA 20MM НА ОПОРЫ

формат 60x60 см, толщина 20 мм

При укладке плиток формата 60x60 толщиной 20мм рекомендуется устанавливать их на высоту не более 2 см.

Форматы 45x90-60x90-80x80-90x90-30x120-40x120-60x120-120x120-120x240 см толщиной 20 мм

Форматы 45x90 - 60x90 - 80x80 - 90x90 - 30x120 - 40x120 - 60x120 - 120x120 - 120x240 толщиной 20 мм подходят для укладки на стяжку, гравий или на опоры высотой не более 2 см с использованием опор, как указано в таблице на каждую плитку для равномерного распределения нагрузок.

# RECOMMENDATIONS FOR RAISED INSTALLATION

RACCOMANDAZIONI PER LA POSA SOPRAELEVATA / EMPFEHLUNGEN FÜR DIE VERLEGUNG ALS DOPPELBODEN / CONSEILS POUR LA POSE SURÉLEVÉE / RECOMENDACIONES PARA LA COLOCACIÓN SOBREELEVADA / РЕКОМЕНДАЦИИ ПО УКЛАДКЕ В ВИДЕ ФАЛЬШПОЛА

**Tiles requiring the application of a glass fibre double net can be supplied with proper backing by Atlas Concorde. For prices of the application of the reinforcements (steel sheet and double fiberglass mesh) and of the installation accessories (pedestals, spacers, clips, ..) see appendix A "Accessories price list LASTRA 20mm" available on MyAtlas.**

Le piastrelle che richiedono l'applicazione di doppia rete in fibra di vetro sono fornite con la necessaria lavorazione da Atlas Concorde. Relativamente ai prezzi dell'applicazione dei rinforzi (foglio di acciaio e doppia rete in fibra di vetro) e degli accessori di posa (supporti, distanziatori, clip, ..) si rimanda all'appendice A: "Listino accessori\_LASTRA 20mm" disponibile su MyAtlas.

Fliesen, für die die Anwendung eines doppelten Glasfasernetz notwendig ist, werden mit dieser Bearbeitung durch Atlas Concorde geliefert. Die Preise der verstärkten Ausführungen (Stahlblatt und doppeltes Glasfasernetz) sowie der Verlegeutensilien (Träger, Distanzstücke, Clips..) finden Sie in Anhang A: „Preisliste Zubehör\_LASTRA 20 mm“ in MyAtlas.

Les carreaux qui exigent l'application d'un double treillis en fibre de verre sont fournis avec le traitement nécessaire réalisé par Atlas Concorde. L'annexe A (Tarif accessoires\_LASTRA 20mm) dans MyAtlas affiche les prix de l'application des renforcements (feuille en acier et double filet en fibre de verre) et des accessoires de pose (supports, entretoises, clips, etc.)

Las baldosas que requieren la aplicación de una red doble de fibra de vidrio son entregadas por Atlas Concorde con la elaboración necesaria. Para los precios de aplicación de los refuerzos (chapa de acero y doble malla de fibra de vidrio) y de los accesorios de instalación (soportes, distanciadores, clips, etc.), véase el Anexo A: "Lista de accesorios\_LASTRA 20mm" disponible en MyAtlas.

Плитки, требующие приклеивания двойной стекловолоконной сетки, поставляются с соответствующей обработкой Atlas Concorde. Цены на упрочняющие элементы (стальной лист, двойная стекловолоконная сетка) и на аксессуары (опоры, распорки, клеммеры и т.д.) приведены в приложении А «Грайс-лист на аксессуары\_LASTRA 20mm», доступном на MyAtlas.

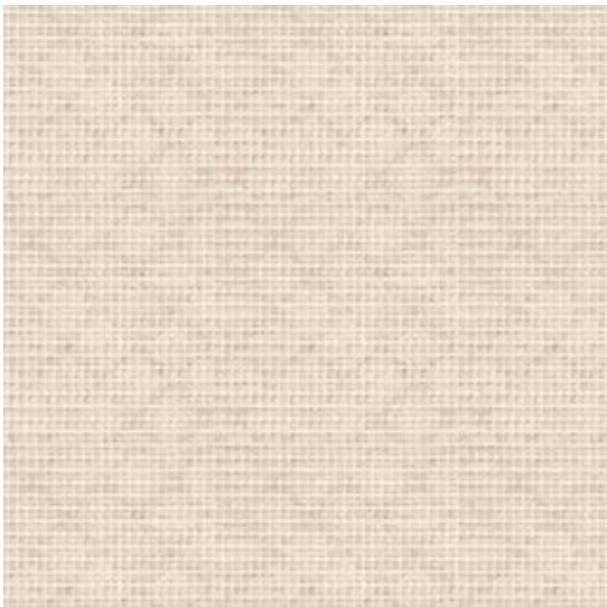

**WARNING: OUTDOOR PAVINGS INSTALLED UNGLUED ABOVE THE GROUND LEVEL ARE SUBJECT TO THE ACTION OF THE WIND, WITH THE RISK, IN SOME CASES, OF BECOMING AIRBORNE THE MANUFACTURER RECOMMENDS TO REQUIRE THE ASSISTANCE OF A QUALIFIED PROFESSIONAL IN ORDER TO CHECK THE SUITABILITY OF THE INSTALLATION SYSTEM ABOVE THE GROUND ADOPTED, IN ACCORDANCE WITH THE LOCAL LAWS AND REGULATIONS AND THE CONDITIONS OF USE. FAILURE TO DO SO COULD RESULT IN SERIOUS INJURY OR PROPERTY DAMAGE.**

**A CERAMIC SLAB INSTALLED ON A RAISED PEDESTAL SYSTEM MAY FRACTURE ON IMPACT IF A HEAVY OBJECT IS DROPPED ONTO IT FROM A HEIGHT, WITH A RISK OF INJURY TO ANYONE STANDING OR WALKING ON SUCH SLAB. FAILURE TO ADHERE TO THE MANUFACTURER'S INSTRUCTIONS FOR INSTALLATION OF SLABS ON RAISED PEDESTAL SYSTEMS MAY RESULT IN SERIOUS INJURY.**

**For further information and recommendations concerning the installation systems please refer to the outdoor section on the atlas concorde website or to the outdoor catalogue.**

ATTENZIONE: LE PAVIMENTAZIONI DA ESTERNO POSATE A SECCO IN QUOTA SONO SOGGETTE ALL'AZIONE DEL VENTO, CON IL RISCHIO DI SOLLEVAMENTO DELLE LASTRE. IL PRODUTTORE RACCOMANDA DI FAR VERIFICARE L'IDONEITÀ DEL SISTEMA DI POSA IN QUOTA DA UN TECNICO ABILITATO IN BASE ALLA NORMATIVA LOCALE VIGENTE ED ALLE CONDIZIONID'USO, AL FINE DI EVITARE IL RISCHIO DI DANNI A PERSONE E COSE.

UNA LASTRA CERAMICA POSATA SU UN SISTEMA SOPRAELEVATO PUÒ ROMPERSI PER IMPATTO QUALORA UN OGGETTO PESANTE CADA SULLA STESSA DA UNA CERTA ALTEZZA, CON IL RISCHIO DI SERI DANNI PER CHIUNQUE POSSA SOSTARE O TRANSITARE SULLA PIASTRELLA STESSA. IL MANCATO RISPETTO DELLE ISTRUZIONI FORNITE DAL PRODUTTORE RELATIVE ALLA POSA SU SISTEMI SOPRAELEVATI PUÒ PROVOCARE SERI DANNI ALLA PERSONE.

Per maggiori informazioni e raccomandazioni di posa si rimanda alla sezione LASTRA 20mm del sito atlas concorde o al catalogo LASTRA 20mm.

WARNUNG: BODENBELÄGE DIE TROCKEN IM AUSSENBEREICH IN DER HÖHE VERLEGT WERDEN, UNTERLIEGEN DER WIRKUNG DES WINDES, WODURCH DIE GEFAHR BESTEHT, DASS DIE PLATTEN AUFGEWORFEN WERDEN. DER HERSTELLER ERTEILT DAHER DIE EMPFEHLUNG, DASS DIE EIGNUNG DES SYSTEMS FÜR EINE VERLEGUNG IN DER HÖHE DURCH EINEN ZUGELASSENEN SACHVERSTÄNDIGEN ÜBERPRÜFT WIRD, WOBEI DIE LOKAL GÜLTIGEN VORSCHRIFTEN UND NUTZUNGSBEDINGUNGEN ZU BEACHTEN SIND, UM DIE GEFAHR VON PERSONEN- UND SACHSCHÄDEN ZU VERMEIDEN.

EINE KERAMIKPLATTE DIE AUF EINEM DOPPELBODENSYSTEM VERLEGT IST, KANN DURCH DEN AUFPRALL EINES AUS EINER BESTIMMTEN HÖHE HERABFALLENDEN GEGENSTANDES ZERBRECHEN. HIER BESTEHT DAS RISIKO SCHWERER VERLETZUNGEN FÜR ALL JENE DIE AUF DER FLIESE GEHEN, ODER STEHEN. BEI NICHTBERÜCKSICHTIGUNG DER VOM HERSTELLER VORGEGBENEN VERLEGEVORSCHRIFTEN FÜR DOPPELBODENSYSTEME, KANN ES ZU SCHWERWIEGENDEN VERLETZUNGEN DER PERSONEN KOMMEN.

Für genauere informationen und verlegehinweise verweisen wir auf unsere webseite LASTRA 20mm atlas concorde oder auf unseren katalog LASTRA 20mm.

AVERTISSEMENT : LES DALLAGES EXTÉRIEURS POSÉS SANS COLLAGE SONT SOUMIS À L'ACTION DU VENT, AVEC LE RISQUE DE SOULÈVEMENT DES PLAQUES, NOTAMMENT CEUX POSÉS AUX ÉTAGES D'UN BÂTIMENT. LE FABRICANT RECOMMANDE DE FAIRE VÉRIFIER PAR UN TECHNICIEN QUALIFIÉ LA BONNE ADAPTATION DU SYSTÈME DE POSE EN ÉTAGES AVEC LA RÉGLEMENTATION EN VIGUEUR ET LES CONDITIONS D'UTILISATION LOCALES, AFIN D'ÉVITER LE RISQUE DE DOMMAGES AUX PERSONNES ET AUX BIENS.

UNE DALLE CÉRAMIQUE POSÉE SUR UN SYSTÈME SURÉLEVÉ PEUT SE CASSER À LA SUITE D'UN IMPACT D'UN OBJET LOURD QUI Y CHUTERAIT D'UNE CERTAINE HAUTEUR, AVEC LE RISQUE DE SÉRIEUX DOMMAGES POUR QUICONQUE STATIONNERAIT OU TRANSITERAIT SUR CE CARREAU. LE NON RESPECT DES INSTRUCTIONS FOURNIES PAR LE FABRICANT RELATIVES À LA POSE SUR DES SYSTÈMES SURÉLEVÉS PEUT PROVOCER DE SÉRIEUX DOMMAGES AUX PERSONNES.

Pour toutes informations complémentaires et recommandations de pose, veuillez vous référer à notre site atlas concorde LASTRA 20mm ou à notre catalogue LASTRA 20mm.

ATENCIÓN: LAS PAVIMENTACIONES DE EXTERIORES COLOCADAS EN SECO EN ALTURA ESTÁN SOMETIDAS A LA ACCIÓN DEL VIENTO, CON EL RIESGO DEL LEVANTAMIENTO DE LAS LOSAS. EL PRODUCTOR ACONSEJA HACER VERIFICAR LA IDONEIDAD DEL SISTEMA DE COLOCACIÓN EN ALTURA POR UN TÉCNICO CALIFICADO EN BASE A LA NORMATIVA LOCAL VIGENTE Y A LAS CONDICIONES DE USO, A FIN DE EVITAR EL RIESGO DE DAÑOS A PERSONAS Y COSAS.

UNA LOSA CERÁMICA COLOCADA SOBRE UN SISTEMA ELEVADO PUEDE ROMPERSE PRODUCTO DE UN IMPACTO EN CASO DE QUE UN OBJETO PESADO CAIGA SOBRE ELLA DESDE UNA CIERTA ALTURA, CON EL RIESGO DE SERIOS DAÑOS PARA CUALQUIERA QUE PUEDA DETENERSE O PASAR SOBRE DICHA BALDOSA. NO RESPETAR LAS INSTRUCCIONES ENTREGADAS POR EL FABRICANTE RESPECTO DE LA COLOCACIÓN SOBRE SISTEMAS SOBREELEVADOS PUEDE PROVOCAR SERIOS DAÑOS A LAS PERSONAS.

Para más informaciones y consejos de colocación se aconseja consultar la sección LASTRA 20mm del sitio atlas concorde o el catálogo LASTRA 20mm.

ВНИМАНИЕ: УЛИЧНЫЕ ПОКРЫТИЯ, УЛОЖЕННЫЕ БЕСКЛЕЕВЫМ СПОСОБОМ НА ОПОРЫ, ПОДВЕРЖЕНЫ ВОЗДЕЙСТВИЮ ВЕТРА И, КАК СЛЕДСТВИЕ, РИСКУ ПОДЪЕМА ИЛИ ОТРЫВА ПЛИТОК. ПОЭТОМУ, ВО ИЗБЕЖАНИЕ ТРАВМИРОВАНИЯ ЛЮДЕЙ ИЛИ ПОВРЕЖДЕНИЯ ИМУЩЕСТВА, СИСТЕМА УКЛАДКИ ДЛЯ СООТВЕТСТВУЮЩИХ УСЛОВИЙ ЭКСПЛУАТАЦИИ И ЕЕ СООТВЕТСТВИЕ МЕСТНЫМ НОРМАМ И ПРАВИЛАМ ДОЛЖНЫ БЫТЬ ПРОВЕРЕНЫ КВАЛИФИЦИРОВАННЫМ СПЕЦИАЛИСТОМ.

ПАДЕНИЕ ТЯЖЕЛОГО ПРЕДМЕТА С БОЛЬШОЙ ВЫСОТЫ МОЖЕТ ПОВЛЕЧЬ ЗА СОБОЙ РАЗЛОМ УЛОЖЕННОЙ НА ОПОРЫ ПЛИТКИ С РИСКОМ ПОЛУЧЕНИЯ ТРАВМЫ ДЛЯ ТОГО, КТО НАХОДИТСЯ НА ПЛИТКЕ. НЕСОБЛЮДЕНИЕ ИНСТРУКЦИЙ ПРОИЗВОДИТЕЛЯ ПО УКЛАДКЕ НА ОПОРЫ МОЖЕТ СТАТЬ ПРИЧИНОЙ СЕРЬЕЗНОГО ТРАВМИРОВАНИЯ.

Более подробная информация и рекомендации по укладке доступны в разделе LASTRA 20mm на сайте atlas concorde или в каталоге LASTRA 20mm.

## Green Project

**Sustainability** / Sostenibilità

**In the environmental and economic sciences, sustainability is defined as the condition of development capable of ensuring the satisfaction of the needs of the present generation without compromising the ability of future generations to realize their own. Several international certifications guarantee that the Atlas Concorde products meet the criteria of sustainable construction, attesting to their low impact on the ecosystem, compliance with declared standards and attention to comfort.**

Nelle scienze ambientali ed economiche, la sostenibilità è definita come condizione di uno sviluppo in grado di assicurare il soddisfacimento dei bisogni della generazione

presente senza compromettere la possibilità delle generazioni future di realizzare i propri. Diverse certificazioni internazionali garantiscono che i prodotti Atlas Concorde rispondono ai criteri del costruire sostenibile, attestandone il basso impatto sull'ecosistema, la conformità agli standard dichiarati e l'attenzione al comfort abitativo.

**Certifications** / Certificazioni



**ISO 9001**

**In 1995 Atlas Concorde obtained ISO 9001 quality certification for its products. It is an international recognition referring to the company's entire quality system, from the receipt of raw materials to their transformation, from the distribution of the product to their placement on the market.**

Sin dal 1995 Atlas Concorde ha ottenuto per i propri prodotti la certificazione di qualità ISO 9001. Si tratta di un riconoscimento internazionale riferito all'intero sistema di qualità aziendale, dall'ingresso delle materie prime alla loro trasformazione, dalla distribuzione del prodotto alla sua immissione sul mercato.

**LEED V4\***

**All Atlas Concorde porcelain floor and white body wall tiles can be used in projects that follow the guidelines of the GREEN BUILDING COUNCIL, which promotes the independent certification system LEED BD&C v4 (Leadership in Energy and Environmental Design, Building Design & Construction), whose parameters establish precise criteria for the design and construction of buildings that are healthy, energy efficient and with low environmental impact. All our products in porcelain stoneware and in white clay can therefore contribute to obtaining the LEED V4 rating of buildings, in relation to different areas: Sustainable Sites, Materials and Resources, Internal Environmental Quality.**

Tutti i prodotti in gres porcellanato e in pasta bianca Atlas Concorde possono essere utilizzati in progetti che seguono le linee guida del GREEN BUILDING COUNCIL, che promuove il sistema di certificazione indipendente LEED BD&C v4 (Leadership in Energy and Environmental Design, Building Design & Construction), i cui parametri stabiliscono precisi criteri di progettazione e realizzazione di edifici salubri, energeticamente efficienti e a impatto ambientale contenuto. Tutti i nostri prodotti in gres porcellanato e in pasta bianca possono quindi contribuire all'ottenimento del rating LEED V4 degli edifici, relativamente a diverse aree tematiche: Siti Sostenibili, Materiali e Risorse, Qualità ambientale Interna.

**EPD**

**Atlas Concorde also has an EPD declaration, which attests to the environmental sustainability of its products. The EPD (Environmental Product Declaration) also assesses the life cycle of a product, from extraction to production, transport, installation, maintenance, and cleaning. Atlas Concorde's EPD declaration was certified by the independent certifying body EPD ITALY.**

Atlas Concorde dispone inoltre di una dichiarazione EPD, che attesta la sostenibilità ambientale dei prodotti. Anche la EPD (Environmental Product Declaration) valuta il ciclo di vita di un prodotto, dall'estrazione all'utilizzo passando per la produzione, il trasporto, l'installazione, la manutenzione e la pulizia. La dichiarazione EPD di Atlas Concorde è stata certificata dall'ente di certificazione indipendente EPD ITALY.

**PEF\***

**The environmental footprint of products (PEF, Product Environmental Footprint, according to Recommendation 2013/179/EU) is a measurement that, based on various criteria, indicates the environmental performance of a product or service over its lifetime, taking into account supply chain activities: from the extraction of raw materials, to the production, use, and end of life of the product. Atlas Concorde has a verified PEF. Atlas Concorde's PEF was verified by the DNV-GL certifying body.**

L'impronta ambientale dei prodotti (PEF, Product Environmental Footprint, secondo la Raccomandazione 2013/179/UE) è una misura che, sulla base di vari criteri, indica le prestazioni ambientali di un prodotto o servizio nel corso del proprio ciclo di vita, tenendo conto delle attività della catena di approvvigionamento: dall'estrazione di materie prime, alla produzione, all'uso e fine vita del prodotto. Atlas Concorde dispone di una PEF verificata. La PEF di Atlas Concorde è verificata dall'organismo di certificazione DNV-GL.

**FDES\***

**Atlas Concorde has also drafted an FDES environmental declaration (Fiche de déclaration environnementale et sanitaire), this also having the purpose of transparently disclosing the product's impact, covering each phase from product extraction to production and finally laying and use.**

Atlas Concorde ha realizzato inoltre la dichiarazione ambientale FDES (Fiche de déclaration environnementale et sanitaire), anch'essa con lo scopo di rendicontare in modo trasparente l'impatto del prodotto, a partire dalla fase di estrazione del prodotto, passando dalla fase di produzione, fino alla posa ed all'utilizzo.

**HPD**

**Atlas Concorde has a HPD (Health Product Declaration) declaration, a complete report on the health characteristics of the finished product, compiled according to the HPD standard.**

Atlas Concorde dispone della dichiarazione HPD (Health Product Declaration), un report completo sulle caratteristiche di salubrità del prodotto finito, compilato secondo lo standard HPD.

**CAM/ISO 14021**

**An environmental declaration according to the ISO 14021 international standard, observance of Minimum Environmental Criteria, and the adoption of sustainability policies demonstrate Atlas Concorde's attention to environmental issues and allow the inclusion of its products in Green Public Tenders.**

La dichiarazione ambientale secondo lo standard internazionale ISO 14021 ed il rispetto dei requisiti dei Criteri Ambientali Minimi permette ad Atlas Concorde, grazie all'adozione di politiche di sostenibilità, di dimostrare l'attenzione alle problematiche ambientali e proporre l'inserimento dei propri prodotti negli Appalti Pubblici Verdi.

**For further details, please refer to:** Per ulteriori dettagli, fare riferimento a: [atlasconcorde.com](http://atlasconcorde.com)

# PRECAUTIONS FOR CLEANING AND MAINTENANCE

## PRECAUZIONI SULLA PULIZIA E MANUTENZIONE

HINWEISE ZUR PFLEGE UND REINIGUNG

PRÉCAUTIONS SUR LE NETTOYAGE ET L'ENTRETIEN

PRECAUCIONES SOBRE LA LIMPIEZA Y MANUTENCIÓN

ЧИСТКА И УХОД



Cleaning and maintenance procedures can be carried out using a common neutral detergent and a direct water jet: the draining power of inclined surfaces and the presence of open joints between slabs encourages the collection of dirt near the discharge points. For large surfaces, it is recommended the use of a washer-dryer and single-brush machines with soft nylon brushes. Please note that a water patina, due to the surface tension feature of liquids, will tend to form on any outdoor surface even when inclined properly. To remove this patina and obtain the complete drying of the floor, it is recommended to push the water towards joints using a scrubbing-brush or to use a wet and dry vacuum cleaner.

Die Reinigung und Pflege kann mit einem normalen Reinigungsmittel und direktem Wasserstrahl durchgeführt werden: die Drainageleistung von geneigten Flächen und das Vorhandensein von Hohlspalten zwischen den Platten leiten den Schmutz dem Abflusssystem zu. Für große Flächen empfiehlt sich der Einsatz von Reinigungsmaschinen und Bürsten mit weichen Nylonborsten. Wir weisen auch darauf hin, dass sich auf jeder Oberfläche für den Außenbereich, auch wenn sie mit einem ausreichenden Gefälle verlegt worden ist, durch die Wirkung der Oberflächenspannung von Flüssigkeiten am Rand der Oberfläche eine dünne Wasserschicht bildet. Um diese zu beseitigen und für die vollständige und korrekte Trocknung des Bodens empfehlen wir das Wasser mit einer Bürste in Richtung Fugen zu schieben oder einen Flüssigkeitssauger zu verwenden.

Las operaciones de limpieza y manutención pueden ser efectuadas con un normal detergente neutro y un chorro directo de agua: las capacidades drenantes de las superficies inclinadas y la presencia de juntas abiertas entre las losas permiten de hecho encauzar la suciedad hacia los puntos de descarga. Para grandes superficies es aconsejable el empleo de máquinas lavadora-secadora y rotativa pulidora con cerdas de nylon suaves. Además hay que tener presente que sobre cualquier superficie para exteriores, si no es colocada con una inclinación oportuna, en el borde la superficie tiende a formarse una ligera patina de agua producto del efecto de tensión superficial de los líquidos. Para eliminar esta película y conseguir el secado completo y correcto del pavimento, se aconseja empujar el agua con una escoba en dirección de las juntas o emplear un aspira líquidos.

Le operazioni di pulizia e manutenzione possono essere eseguite con un normale detergente neutro e un getto diretto di acqua: le capacità drenanti delle superfici in pendenza e la presenza di fughe aperte tra le lastre consentono infatti di convogliare lo sporco verso i punti di scarico. Per grandi superfici è consigliabile l'utilizzo di macchine lavasciuga e monospazzole con setole in nylon morbide. Si tenga inoltre presente che su qualunque superficie per esterni, seppur posata in opportuna pendenza, tende a formarsi sul bordo della superficie una leggera patina di acqua per via dell'effetto di tensione superficiale dei liquidi. Per eliminare questa patina e ottenere l'asciugatura completa e corretta del pavimento, si consiglia di spingere l'acqua con uno spazzolone verso la direzione delle fughe o di utilizzare un aspiraliquidi.

Les opérations de nettoyage et d'entretien peuvent être effectuées avec un détergent neutre normal et un jet d'eau direct : les capacités drainantes des surfaces en pente et la présence de joints ouverts entre les dalles permettent en effet de diriger les saletés vers les points d'évacuation. Pour des grandes surfaces, nous conseillons d'utiliser des aspirateurs nettoyeurs et des monobrosses équipées de brosses en poils nylon souples. Il convient également de noter que sur toute surface pour l'extérieur non convenablement posée en pente, une légère patine d'eau a tendance à se former à cause de l'effet de tension des liquides en surface. Pour éliminer cette patine et obtenir le séchage complet et correct du sol, nous conseillons de pousser l'eau à l'aide d'une brosse à carrelage en direction des joints ou d'utiliser un aspirateur à liquide.

Чистку плиток можно выполнять нейтральным моющим средством и прямой струей воды: дренажные способности наклонной поверхности и наличие открытых швов между плитками обеспечивают отвод грязной воды к стокам. Для больших поверхностей рекомендуется использовать поломочные машины или однодисковые полотеры с мягкими нейлоновыми щетками. Следует иметь в виду, что на наружных покрытиях, уложенных без надлежащего уклона, в силу явления поверхностного натяжения жидкостей может образоваться тонкая водная пленка. Для ее удаления и полного высушивания покрытия рекомендуется согнать воду щеткой-шваброй в сторону швов или использовать водос.

# V-SHADE COLOUR-SHADING

## STONALIZZAZIONE V-SHADE

DENUANCEMENT, V-SHADE

V-SHADE, MARMORIERUNG

CONTRASTE, V-SHADE

ЦВЕТОВОЕ ОТЛИЧИЕ, V-SHADE



### V1

Uniform appearance

Aspetto uniforme

Aspect uniforme

Gleichmäßiges Erscheinungsbild

Aspecto uniforme

Однородный вид



### V2

Slight variation

Variatione minima

Variation minimale

Leichte Abweichung

Variación mínima

Минимальная Неоднородность

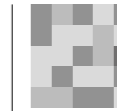

### V3

Moderate variation

Variatione moderata

Variation modérée

Mäßige Abweichung

Variación moderada

Умеренная Неоднородность

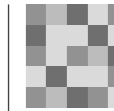

### V4

Substantial variation

Variatione sostanziale

Variation substantielle

Grundlegende Abweichung

Variación sustancial

Значительная Неоднородность

The V-Shade classification indicates the colour shading level of a product, that is to say the chromatic and/or surface variation among tiles of the same collection. A strong colour shading is typical of ceramic collections that reproduce natural stones and marble. A moderate colour shading is typical of ceramic collections for which a homogeneous chromatic surface is an aesthetic feature of contemporary design.

La classification VShade indique le niveau de gradation du produit, c'est-à-dire de variation chromatique et/ou superficielle entre des dalles d'une même collection. Une forte variation est conseillée lorsque l'on utilise une collection qui rappelle des matériaux naturels comme la pierre et le marbre. Des variations de tons plus modérées caractérisent des collections où l'homogénéité chromatique superficielle est une qualité esthétique ou véritable indice de design contemporain.

La clasificación V-Shade indica el nivel de variación de tono del producto, o de variación cromática y/o superficial que existe entre las baldosas de una misma colección. Una variación de tono significativa es indicada en las colecciones que evocan materiales naturales como la piedra y el mármol. Variaciones de tono más moderadas caracterizan colecciones en que la homogeneidad cromática superficial es un valor estético índice de un diseño contemporáneo.

La classificazione VShade indica il livello di stonalizzazione del prodotto, ovvero di variazione cromatica e/o superficiale che intercorre tra le piastrelle di una stessa collezione. Una forte stonalizzazione è indicata nelle collezioni che richiamano materiali naturali come la pietra e il marmo. Stonalizzazioni più moderate caratterizzano collezioni in cui l'omogeneità cromatica superficiale è un valore estetico indice di un design contemporaneo.

Die Klassifizierung V-Shade gibt das Niveau des Farbverlaufs des Produktes oder die Abweichung des Farbtons und/oder Oberfläche unter den Fliesen der gleichen Kollektion an. Starke Farbunterschiede zeigen sich vor allem in Kollektionen, die natürliche Materialien wie Stein und Marmor nachempfinden. Weniger starke Farbunterschiede kennzeichnen Kollektionen deren Farbhomogenität der Oberflächen ein ästhetischer Wert des zeitgenössischen Designs darstellen.

Классификация V-Shade указывает на уровень цветовой или фактурной неоднородности плиток, т.е. на отличия по цвету или по фактуре между плитками одной коллекции. Высокая цветовая неоднородность присутствует на плитках, имитирующих природные материалы, например, камень или мрамор. Умеренная неоднородность цвета наблюдается на плитках, предназначенных для оформления интерьеров или экстерьеров в современном стиле.

± 20 mm / ± 30 mm

TECHNICAL FEATURES - CARATTERISTICHE TECNICHE - TECHNISCHE DATEN - CARACTÉRISTIQUES TECHNIQUES - CARACTERÍSTICAS TÉCNICAS - ТЕХНИЧЕСКИЕ ХАРАКТЕРИСТИКИ

Compliant with standards EN 14411 annex G group Bla Conforme alla norma EN 14411 Appendice G gruppo Bla - Compliant with standards ISO 13006 annex G group Bla Conforme alla norma ISO 13006 Appendice G gruppo Bla

		Requirements for nominal size N Requisiti per dimensione nominale N			LASTRA 20mm
		7 cm ≤ N < 15 cm (mm)	(%)	N ≥ 15 cm (mm)	
Regularity characteristics	Length and width Lunghezza e larghezza	± 0,9 (*)	± 0,6 (*)	± 2,0 (*)	46 kg/mq
		± 0,5 (**)	± 5 (**)	± 0,5 (**)	
		± 0,75 (***)	± 0,5 (***)	± 1,5 (***)	
	Rectangularity (Measurement only on short edges when L1 ≥ 3) Ortogonalità (Misurazione da condurre solo sui lati corti quando L1 ≥ 3)			± 0,3 % ± 1,0 mm	
	Surface flatness Planarità			± 0,3 % ± 0,5 mm	
Structural characteristics	Water absorption Massa d'acqua assorbita	ISO 10545-3	≤ 0,5% Individual Maximum 0,6% - ≤ 0,5% Valore massimo singolo 0,6%		≤ 0,1 %
		ASTM C373	Requirement ANSI A1371 Water Absorption Max ≤ 0,5% ± 0,5%		≤ 0,5 %
	Breaking strength Storzo di rottura	ISO 10545-4	S ≥ 1300 N		S ≥ 10000 N
		ISO 10545-4	R ≥ 35 N/mm²		30mm: S > 20000 N
	Bulk mechanical characteristics	Modulus of rupture Resistenza alla flessione	EN 1339 Annex F	-	
ISO 10545-5			Declared value Dichiarare un valore	Test method available Metodo di prova disponibile	≥ 0,55
Surface mechanical characteristics	Mohs hardness Durezza Mohs	EN 101	-		8
		ISO 10545-6	≤ 175 mm³		≤ 150 mm³
Thermal and hygrothermic characteristics	Coefficient of thermal linear expansion Coefficiente di dilatazione termica lineare	ISO 10545-8	Declared value Dichiarare un valore	Test method available Metodo di prova disponibile	≤ 7 MK <sup>-1</sup>
		ISO 10545-9	Pass according to ISO 10545-1 Test superato in accordo con ISO 10545-1	Test method available Metodo di prova disponibile	Resistant Resiste
	ISO 10545-10	Declared value Dichiarare un valore	Test method available Metodo di prova disponibile	≤ 0,01% (0,1mm/m)	
	ISO 10545-12	Pass according to ISO 10545-1 Test superato in accordo con ISO 10545-1	Required Metodo di prova richiesto	Resistant Resiste	
	EN 1348	Declared value Dichiarare un valore	-	≥ 1,0 N/mm² (Class C2 - EN 12004)	
Physical properties	Reaction to fire Reazione al fuoco	-	Class A1 or A1 <sub>s</sub> Classe A1 oppure A1 <sub>s</sub>	-	A1 - A1 <sub>s</sub>
		ISO 10545-13	Declared value Dichiarare una Classe	Manufacturer is to state classification Secondo la classificazione indicata dal fabbricante	LA
Chemical characteristics	Resistance to household chemicals and swimming pool salts Resistenza ai prodotti chimici di uso domestico ed agli additivi per piscina	Minimum Class B (UB for unglazed tiles) Classe minima B (UB per piastrelle non smaltate)			A
		ISO 10545-13	Declared value Dichiarare una Classe	Declared Class Dichiarare una Classe	HA
Safety characteristics (*)	Shod Ramp Test Metodo della rampa "calzato"	DIN 51130	Declared value Dichiarare un valore	-	R11
		DIN 51097	Declared value Dichiarare un valore	-	A+B+C
	BS 7976	PTV ≥ 36 classifies the surface as "low slip risk"			≥ 36 Dry ≥ 36 Wet
	AS 4586	Declared Classification of the pedestrian surface materials according to the Wet Pendulum Test			Class P4
	UNE-ENV 12633	Declared value Dichiarare un valore			Class C3
Safety characteristics (*)	Coefficient of friction (COF) Coefficiente di attrito	B.C.R.A. Rep. CEC/81	D. M. 236/89 del 14/06/89 μ > 0,40 per elemento scivolante gomma dura su pavimentazione bagnata μ > 0,40 per elemento scivolante cuoio su pavimentazione asciutta		> 0,40 Asciutto > 0,40 Bagnato
		ANSI A137.1-2012	ANSI A.137.1 Requires a minimum value of 0.42 for commercial areas that are likely to be wet.		

Technical data Dati tecnici			
Nominal dimension of size Dimensione nominale dei lati	Manufacturing dimension of size Dimensione di fabbricazione dei lati	Weight of slab Peso singola lastra	Weight of slab per m² Peso della lastra al mq
22,5cm x 22,5cm	size not rectified formato non rettificato	2,05 kg	46 kg/mq
22,5cm x 45,4cm	size not rectified formato non rettificato	4,1 kg	
30cm x 60cm	298mm x 598mm	8,25 kg	
60cm x 60cm	598mm x 598mm	16,5 kg	
60cm x 90cm	598mm x 898mm	24,25 kg	
90cm x 90cm	895mm x 895mm	37,6 kg	
45cm x 90cm	446mm x 895mm	18,5 kg	
80cm x 80cm	798mm x 798mm	29,7 kg	
30cm x 120cm	296mm x 1195mm	16,5 kg	
60cm x 120cm	595mm x 1195mm	33,2 kg	
120cm x 120cm	1198mm x 1198mm	67,66 kg	
120cm x 240cm	1198mm x 2398mm	134 kg	
60cm x 60cm x 3cm	598mm x 598mm	23,68 kg	69 kg/mq

Physical-mechanical features in accordance with EN 1339  
Caratteristiche fisiche-meccaniche secondo EN 1339

Technical feature Caratteristica tecnica	EN 1339 standard Norma EN 1339	Performance of slab Prestazione Lastra
Water absorption Assorbimento d'acqua	Annex E Appendice E	< 0,1%
Bending strength Resistenza alla flessione	Annex F Appendice F	Marking/Marcatura ≥ T11 22,5x22,5 Marking/Marcatura ≥ U4 22,5x45,4 Marking/Marcatura ≥ T11 60x60 Marking/Marcatura ≥ U7 30x60 Marking/Marcatura ≥ U11 90x90 Marking/Marcatura ≥ U4 60x90 Marking/Marcatura ≥ U4 45x90 Marking/Marcatura ≥ T11 120x120 Marking/Marcatura ≥ U25 per 60x60x3
Breaking load Carico di rottura	Annex F Appendice F	Marking/Marcatura ≥ T11 22,5x22,5 Marking/Marcatura ≥ U4 22,5x45,4 Marking/Marcatura ≥ T11 60x60 Marking/Marcatura ≥ U7 30x60 Marking/Marcatura ≥ U11 90x90 Marking/Marcatura ≥ U4 60x90 Marking/Marcatura ≥ U4 45x90 Marking/Marcatura ≥ T11 120x120 Marking/Marcatura ≥ U25 per 60x60x3
Frost resistant in presence of de-icing salts Resistenza al gelo in presenza di Sali Disgelanti	Annex D Appendice D	Resistant Resiste

Mechanical features with raised installation in accordance with EN 12825  
Caratteristiche meccaniche posa sopraelevata secondo EN 12825

Static load capacity Carico Statico	Average performance of slab (kN) Prestazione Media Lastra (kN)
Centre Centro	≥ 7,0 60x60x2 / ≥ 5,0 30x60x2 / 45x90x2 ≥ 10,0 30x120x2 / ≥ 10,0 60x120x2 ≥ 7,0 60x90x2 / ≥ 7,0 90x90x2 ≥ 14 120x120x2 / ≥ 16 60x60x3
Side centre Centro Lato	≥ 5,5 60x60x2 / ≥ 6,0 30x60x2 / ≥ 5,0 45x90x2 ≥ 5,0 60x90x2 / ≥ 7,0 30x120x2 / ≥ 9,0 60x120x2 ≥ 6 90x90x2 / ≥ 14 120x120x2 / ≥ 15 60x60x3
Diagonal Diagonale	≥ 5,5 60x60x2 / ≥ 10,0 30x60x2 / ≥ 7,0 45x90x2 ≥ 8,0 30x120x2 / ≥ 8,0 60x120x2 / ≥ 9 60x90x2 ≥ 14 120x120x2 / ≥ 17 60x60x3

UPEC	UPEC+
ARBOR Porcelain tiles (15x30 cm), ARKSHADE Porcelain tiles, AXI, BOOST Porcelain tiles, BRAVE Porcelain tiles, DWELL Porcelain tiles, ETIC PRO, MARVEL PRO Porcelain tiles, MARVEL STONE Porcelain tiles, SEASTONE, SUNROCK, TRUST, BLOCK	Classification UPEC - in via di certificazione / Classification UPEC - en cours de certification : RAW Porcelain tiles, BLAZE Porcelain tiles, DOLMEN PRO, AIX Porcelain tiles, FLUX
AIX Porcelain tiles, AXI, BLAZE, BOOST Porcelain tiles, BRAVE Porcelain tiles, DIEISIS, DOLMEN PRO, FLUX Porcelain tiles, KONE Porcelain tiles, RAW Porcelain tiles, SEASTONE, SUNROCK, TRUST, BLOCK	

Si consiglia la consultazione della pagina:  
http://webapp.csib.it/upec-ceramique/index.php?view=TitulaireListeProduits&sid=39&tid=1  
Per ulteriori informazioni scrivere a france@atlascorcord.it  
On vous conseille de vous connecter à:  
http://webapp.csib.it/upec-ceramique/index.php?view=TitulaireListeProduits&sid=39&tid=1  
Pour tous renseignements complémentaires merci d'écrire à france@atlascorcord.it

± 9 mm / ± 9,5 mm

TECHNICAL FEATURES - CARATTERISTICHE TECNICHE - TECHNISCHE DATEN - CARACTÉRISTIQUES TECHNIQUES - CARACTERÍSTICAS TÉCNICAS - ТЕХНИЧЕСКИЕ ХАРАКТЕРИСТИКИ

Compliant with standards EN 14411 annex G group Bla Conforme alla norma EN 14411 Appendice G gruppo Bla - Compliant with standards ISO 13006 annex G group Bla Conforme alla norma ISO 13006 Appendice G gruppo Bla

		Requirements for nominal size N Requisiti per dimensione nominale N			GRIP Boost Pro, Brave, Diesis, Dolmen Pro, Etic Pro, Exence, Flux, Kif, Kone, Lims, Nash, Norde, Prism, Raw, Trust		TEXTURED Aix, Axi, Block, Dolmen Pro, Kava, Marvel Pro, Marvel Stone		ROCCIA Norde	
		7 cm ≤ N < 15 cm (mm)	(%)	N ≥ 15 cm (mm)	± 0,3 % ± 1,0 mm	± 0,3 % ± 1,0 mm	± 0,3 % ± 1,0 mm	± 0,3 % ± 1,5 mm	± 0,3 % ± 1,5 mm	± 0,3 % ± 1,5 mm
Regularity characteristics	Length and width Lunghezza e larghezza	± 0,9 (*)	± 0,6 (*)	± 2,0 (*)	± 0,3 % ± 1,0 mm	± 0,3 % ± 1,0 mm	± 0,3 % ± 1,0 mm	± 0,3 % ± 1,0 mm	± 0,3 % ± 1,0 mm	Suitable for Conforme
		± 0,5 (**)	± 5 (**)	± 0,5 (**)	± 0,3 % ± 0,5 mm	± 0,3 % ± 0,5 mm	± 0,3 % ± 0,5 mm	± 0,3 % ± 0,5 mm	± 0,3 % ± 0,5 mm	Suitable for Conforme
		± 0,75 (***)	± 0,5 (***)	± 1,5 (***)	± 0,3 % ± 0,8 mm	± 0,3 % ± 0,8 mm	± 0,3 % ± 0,8 mm	± 0,3 % ± 0,8 mm	± 0,3 % ± 0,8 mm	Suitable for Conforme
	Rectangularity (Measurement only on short edges when L1 ≥ 3) Ortogonalità (Misurazione da condurre solo sui lati corti quando L1 ≥ 3)			± 0,3 % ± 1,5 mm	± 0,3 % ± 1,5 mm	± 0,3 % ± 1,5 mm	± 0,3 % ± 1,5 mm	± 0,3 % ± 1,5 mm	± 0,3 % ± 1,5 mm	Suitable for Conforme
	Surface flatness Planarità			± 0,3 % ± 1,5 mm	± 0,3 % ± 1,5 mm	± 0,3 % ± 1,5 mm	± 0,3 % ± 1,5 mm	± 0,3 % ± 1,5 mm	± 0,3 % ± 1,5 mm	Suitable for Conforme
Structural characteristics	Water absorption Massa d'acqua assorbita	ISO 10545-3	≤ 0,5% Individual Maximum 0,6% - ≤ 0,5% Valore massimo singolo 0,6%		≤ 0,1 %	≤ 0,1 %	≤ 0,1 %	≤ 0,1 %	≤ 0,1 %	≤ 0,1 %
		ASTM C373	Requirement ANSI A1371 Water Absorption Max ≤ 0,5% ± 0,5%		≤ 0,5 %	≤ 0,5 %	≤ 0,5 %	≤ 0,5 %	≤ 0,5 %	≤ 0,5 %
	Breaking strength Storzo di rottura	ISO 10545-4	S ≥ 1300 N		S ≥ 1500 N	S ≥ 1500 N	S ≥ 1500 N	S ≥ 1500 N	S ≥ 1500 N	S ≥ 1500 N
		ISO 10545-4	R ≥ 35 N/mm²		R ≥ 40 N/mm²	R ≥ 40 N/mm²	R ≥ 40 N/mm²	R ≥ 40 N/mm²	R ≥ 40 N/mm²	R ≥ 40 N/mm²
	Bulk mechanical characteristics	Modulus of rupture Resistenza alla flessione	ISO 10545-5	Declared value Dichiarare un valore	Test method available Metodo di prova disponibile	≥ 0,55	≥ 0,55	≥ 0,55	≥ 0,55	≥ 0,55
EN 101			-		8	8	8	8	8	8
Surface mechanical characteristics	Resistance to deep abrasion of unglazed tiles (removed volume) Resistenza all'abrasione profonda delle piastrelle non smaltate (volume materiale asportato)	ISO 10545-6	≤ 175 mm³		≤ 150 mm³	≤ 150 mm³	≤ 150 mm³	≤ 150 mm³	≤ 150 mm³	≤ 150 mm³
		ISO 10545-8	Declared value Dichiarare un valore	Test method available Metodo di prova disponibile	≤ 7 MK <sup>-1</sup>	≤ 7 MK <sup>-1</sup>	≤ 7 MK <sup>-1</sup>	≤ 7 MK <sup>-1</sup>	≤ 7 MK <sup>-1</sup>	≤ 7 MK <sup>-1</sup>
Thermal and hygrothermic characteristics	Thermal shock resistance Resistenza agli sbalzi termici	ISO 10545-9	Pass according to ISO 10545-1 Test superato in accordo con ISO 10545-1	Test method available Metodo di prova disponibile	Resistant Resiste	Resistant Resiste	Resistant Resiste	Resistant Resiste	Resistant Resiste	Resistant Resiste
		ISO 10545-10	Declared value Dichiarare un valore	Test method available Metodo di prova disponibile	≤ 0,01% (0,1mm/m)	≤ 0,01% (0,1mm/m)	≤ 0,01% (0,1mm/m)	≤ 0,01% (0,1mm/m)	≤ 0,01% (0,1mm/m)	≤ 0,01% (0,1mm/m)
Physical properties	Bond strength/adhesion for improved cementitious adhesives Adesione a trazione con adesivi cementizi migliorati	EN 1348	Declared value Dichiarare un valore	-	≥ 1,0 N/mm² (Class C2 - EN 12004)	≥ 1,0 N/mm² (Class C2 - EN 12004)	≥ 1,0 N/mm² (Class C2 - EN 12004)	≥ 1,0 N/mm² (Class C2 - EN 12004)	≥ 1,0 N/mm² (Class C2 - EN 12004)	≥ 1,0 N/mm² (Class C2 - EN 12004)
		ISO 10545-13	Declared value Dichiarare una Classe	Manufacturer is to state classification Secondo la classificazione indicata dal fabbricante	LA	LA	LA	LA	LA	LA
Chemical characteristics	Resistance to household chemicals and swimming pool salts Resistenza ai prodotti chimici di uso domestico ed agli additivi per piscina	Minimum Class B (UB for unglazed tiles) Classe minima B (UB per piastrelle non smaltate)			A	A	A	A	A	A
		ISO 10545-13	Declared value Dichiarare una Classe	Declared Class Dichiarare una Classe	HA	HA	HA	HA	HA	HA
Safety characteristics (*)	Shod Ramp Test Metodo della rampa "calzato"	DIN 51130	Declared value Dichiarare un valore	-	R11	R11	R11	R11	R11	R11
		DIN 51097	Declared value Dichiarare un valore	-	A+B+C	A+B+C	A+B+C	A+B+C	A+B+C	A+B+C
	BS 7976	PTV ≥ 36 classifies the surface as "low slip risk"			≥ 36 Dry ≥ 36 Wet	Class 3	Class 3	Class 3	Class 3	Class 3
	AS 4586	Declared Classification of the pedestrian surface materials according to the Wet Pendulum Test			Class P4	Class P4	Class P4	Class P4	Class P4	Class P4
	UNE-ENV 12633	Declared value Dichiarare un valore			Class C3	Class C3	Class C3	Class C3	Class C3	Class C3
Safety characteristics (*)	Coefficient of friction (COF) Coefficiente di attrito	B.C.R.A. Rep. CEC/81	D. M. 236/89 del 14/06/89 μ > 0,40 per elemento scivolante gomma dura su pavimentazione bagnata μ > 0,40 per elemento scivolante cuoio su pavimentazione asciutta		> 0,40 Asciutto > 0,40 Bagnato	> 0,40 Asciutto > 0,40 Bagnato	> 0,40 Asciutto > 0,40 Bagnato	> 0,40 Asciutto > 0,40 Bagnato	> 0,40 Asciutto > 0,40 Bagnato	> 0,40 Asciutto > 0,40 Bagnato
		ANSI A137.1-2012	ANSI A.137.1 Requires a minimum value of 0.42 for commercial areas that are likely to be wet.			> 0,42 Wet	> 0,42 Wet	> 0,42 Wet	> 0,42 Wet	> 0,42 Wet

(\*) Anti-slip performance is guaranteed at the time of delivery of the product. Le prestazioni anti-slip vengono garantite al momento della consegna del prodotto.  
 (\*\*) The permissible deviation, in % or mm, of the average size for each tile (2 or 4 sides) from work size (W). Deviazione ammissibile, in % oppure mm, della dimensione media di ogni piastrella (2 oppure 4 lati) dalla dimensione di fabbricazione (W).  
 (\*\*\*) The permissible deviation, in % or mm, of the average thickness for each tile from the work size thickness (W). Deviazione ammissibile, in % oppure mm, dello spessore medio di ogni piastrella dallo spessore riportato nella dimensione di fabbricazione (W).  
 (\*\*\*\*) The maximum permissible deviation from straightness, in % or mm, related to the corresponding work sizes (W). Deviazione massima ammissibile di rettilineità, in % oppure mm, in rapporto alle dimensioni di fabbricazione (W) corrispondenti.  
 (\*\*\*\*\*) The maximum permissible deviation from rectangularity, in % or mm, related to the corresponding work sizes (W). Deviazione massima ammissibile di ortogonalità, in % oppure mm, in rapporto alle dimensioni di fabbricazione (W) corrispondenti.  
 (\*\*\*\*\*) The maximum permissible deviation from centre curvature, in % or mm, related to diagonal calculated from the work sizes (W). Deviazione massima ammissibile della curvatura del centro, in % oppure mm, in rapporto alla diagonale calcolata secondo le dimensioni di fabbricazione (W).  
 c.c. The maximum permissible deviation from edge curvature, in % or mm, related to the corresponding work sizes (W). Deviazione massima ammissibile della curvatura dello spigolo, in % oppure mm, in rapporto alle dimensioni di fabbricazione (W) corrispondenti.  
 w. The maximum permissible deviation from warpage, in % or mm, related to diagonal calculated from the work sizes (W). Deviazione massima ammissibile dello sverglimento, in % oppure mm, in rapporto alla diagonale calcolata secondo le dimensioni di fabbricazione (W).

# PACKAGING

IMBALLI  
VERPACKUNG  
PACKAGING ET EMBALLAGES  
PACKAGING Y EMBALAJES  
УПАКОВКА

	<b>Pieces x box</b> <b>Pezzi x scatola</b> Stück pro Karton Pièces par boîte Piezas por caja Штук в коробке	<b>M² x box</b> <b>M² x scatola</b> M² pro Karton M² par boîte M² por caja Кв.м в коробке	<b>Boxes x pallet</b> <b>Scatole x pallet</b> Kartons pro Palette Boîtes par palette Cajas por pallet Коробок на поддоне	<b>Kg x box</b> <b>Kg x scatola</b> Kg pro Karton Kg par boîte Kg por caja кг в коробке	<b>M² x pallet</b> <b>M² x pallet</b> M² pro Palette M² par palette M² por pallet Кв.м на поддоне
<b>± 20 mm</b>					
22,5x45,4	5	0,51	40	20,43	20,40
22,5x22,5	11	0,56	40	22,72	22,24
30x60	3	0,54	40	24,00	21,60
60x60	2	0,72	30	33,00	21,60
45x90	2	0,81	27	37,00	21,87
60x90	2	1,08	18	48,50	19,44
30x120	2	0,72	36	33,00	25,92
60x120	1	0,72	35	33,35	25,20
90x90	1	0,81	18	37,60	14,58
120x120	1	1,44	20	67,66	28,80
120x240	1	2,88	9	134,00	25,92
<b>± 30 mm</b>					
60x60	2	0,72	30	33,00	21,60
<b>± 9 mm / ± 9,5 mm</b>					
22,5x45,3	12	1,22	34	23,70	41,59
22,5x22,5	20	1,01	42	19,40	42,53
30x60	7	1,26	40	24,85	50,40
60x60	3	1,08	40	21,57	43,20
15x90	10	1,35	36	26,67	48,60
22,5x90	6	1,22	36	25,20	43,74
37,5x75	4	1,13	48	23,68	54,00
20x120	6	1,44	42	31,10	60,48
18,5x150	4	1,11	40	23,68	44,40
120x120	2	2,88	20	58,00	57,60
<b>± 8 mm</b>					
30x30	13	1,17	48	20,28	56,16
30x60	8	1,44	40	26,00	57,60
<b>± 8,6 mm</b>					
15x30	28	1,26	44	22,80	55,44



MADE IN ITALY. MADE TO EXCEL.

## MADE IN ITALY

The Made in Italy logo of Atlas Concorde stands for style, quality and ethics. Having firmly adhered to the Ethical Code promoted by Confindustria Ceramica, Atlas Concorde places the Made in Italy logo on all the products designed and produced in Italy, that is to say ceramic tiles, decorations and the majority of special trim tiles. Only a small amount of the latter is manufactured in Spain. Atlas Concorde products are produced using eco-friendly technologies, top quality and safe raw materials with the best working conditions guaranteed for our personnel. For these reasons, Atlas Concorde's Made in Italy is the expression of strong values such as style, design, product quality, and respect for the environment and the people who live in it.

Il marchio Made in Italy di Atlas Concorde è sinonimo di stile, qualità ed etica. Avendo aderito con convinzione al Codice Etico di Confindustria Ceramica, Atlas Concorde appone il marchio Made in Italy su tutti i prodotti studiati, progettati e realizzati in Italia, nella fattispecie tutte le piastrelle di ceramica, le decorazioni e la maggioranza dei pezzi speciali. Solo un ristretto numero di questi ultimi è fabbricato in Spagna. I prodotti Atlas Concorde sono inoltre realizzati con tecnologie rispettose dell'ambiente, utilizzando materie prime eccellenti e sicure, garantendo le migliori condizioni di lavoro. Per queste ragioni il Made in Italy di Atlas Concorde è espressione di valori forti quali stile, design, qualità del prodotto, attenzione all'ambiente e alle persone.



The Ceramics of Italy logo is an exclusive identification on ceramic products which have effectively been made in Italy by companies that are a part of the Confindustria Ceramica and who adhered to its Ethical Code. This Code, promoted and created by Confindustria Ceramica, commits all companies to communicate, clearly and with transparency, the origin of their products.

Il marchio Ceramics of Italy contrassegna esclusivamente i prodotti ceramici effettivamente realizzati in Italia da un'azienda associata a Confindustria Ceramica che ha sottoscritto il Codice Etico. Il Codice, redatto dalla stessa Confindustria Ceramica, impegna a comunicare con chiarezza l'origine dei prodotti.

[www.ceramica.info](http://www.ceramica.info)



Ceramiche Atlas Concorde S.p.A.  
Via Canaletto 141  
41042 Spezzano di Fiorano (MO) - Italia

Atlas Concorde USA, Inc.  
117 Seaboard Lane - Suite F170  
Franklin, TN 37067 - USA

Atlas Concorde Russia  
Business centre "Meliora Place"  
Prospekt Mira 6  
129090 Moscow - Russia

[atlasconcorde.com](http://atlasconcorde.com)