

2 0 2 1

D E S I G N Y O U R F U T U R E

Index

COMPANY p. 04

PRODUCT RANGE SUM UP p. 28

30 PORCELAIN TILES

48 WALL TILES

58 PORCELAIN TILE DECORS

86 WALL TILE DECORS

2021 COLLECTIONS p. 100

TECHNICAL SPECIFICATIONS p. 570

574 GREEN PROJECT

575 V-SHADE, COLOUR-SHADING

576 SIZES RANGE

580 PORCELAIN TILES TECHNICAL SPECIFICATIONS

595 UPEC CERTIFICATION

596 DESTINATIONS OF USE

598 PORCELAIN TILES FOR OUTDOORS

600 ANTI-SLIP CLASSIFICATION

602 WALL TILES TECHNICAL SPECIFICATIONS

606 LAYING SUGGESTIONS

618 GENERAL PACKING AND WEIGHT

622 GENERAL SALES CONDITIONS

2021 Collections

100	3D WALL DESIGN	Wall Tiles
360	AIX	Porcelain tiles - Wall Tiles
444	ARBOR	Porcelain tiles
112	ARKSHADE	Porcelain tiles - Wall Tiles
128	ARTY	Wall Tiles
450	AXI	Porcelain tiles
240	BLAZE	Porcelain tiles - Wall Tiles
134	BOOST	Porcelain tiles - Wall Tiles
146	BOOST PRO	Porcelain tiles - Wall Tiles
372	BRAVE	Porcelain tiles - Wall Tiles
356	BRICK ATELIER	Wall Tiles
108	CANONE INVERSO Piero Lissoni	Porcelain tiles
382	DOLMEN PRO	Porcelain tiles
160	DWELL	Porcelain tiles - Wall Tiles
458	ETIC	Porcelain tiles
464	ETIC PRO	Porcelain tiles
172	EWALL	Wall Tiles
470	EXENCE	Porcelain tiles
478	HEARTWOOD	Porcelain tiles
496	GRANIGLIATI	Porcelain tiles
498	GREENCOLORS	Porcelain tiles
499	GROUNDTRACK	Porcelain tiles
390	KLIF	Porcelain tiles - Wall Tiles
400	KONE	Porcelain tiles
406	LIMS	Porcelain tiles - Wall Tiles
178	MARK	Porcelain tiles
252	MARVEL	Porcelain tiles - Wall Tiles
270	MARVEL DREAM	Porcelain tiles - Wall Tiles
284	MARVEL EDGE	Porcelain tiles - Wall Tiles
300	MARVEL GEMS	Porcelain tiles
302	MARVEL PRO	Porcelain tiles - Wall Tiles
320	MARVEL SHINE	Porcelain tiles - Wall Tiles
342	MARVEL STONE Marble Look	Porcelain tiles - Wall Tiles
418	MARVEL STONE Stone Look	Porcelain tiles
186	MEK	Porcelain tiles - Wall Tiles
484	NASH	Porcelain tiles
490	NID	Porcelain tiles
424	NORDE	Porcelain tiles
198	PRISM	Porcelain tiles - Wall Tiles
220	RAW	Porcelain tiles - Wall Tiles
432	SEASTONE	Porcelain tiles
438	TRUST	Porcelain tiles
234	VENTI BOOST	Porcelain tiles

3D WALL & DECOR	100	3D WALL DESIGN	Wall Tiles
	108	CANONE INVERSO	Porcelain tiles

	112	ARKSHADE	Porcelain tiles - Wall Tiles
	128	ARTY	Wall Tiles
	134	BOOST	Porcelain tiles - Wall Tiles
	146	BOOST PRO	Porcelain tiles - Wall Tiles
CONCRETE & RESIN LOOK	160	DWELL	Porcelain tiles - Wall Tiles
	172	EWALL	Wall Tiles
	178	MARK	Porcelain tiles
	186	MEK	Porcelain tiles - Wall Tiles
	198	PRISM	Porcelain tiles - Wall Tiles
	220	RAW	Porcelain tiles - Wall Tiles
	234	VENTI BOOST	Porcelain tiles - Wall Tiles

METAL LOOK	240	BLAZE	Porcelain tiles - Wall Tiles
-------------------	-----	-------	------------------------------

	252	MARVEL	Porcelain tiles - Wall Tiles
	270	MARVEL DREAM	Porcelain tiles - Wall Tiles
	284	MARVEL EDGE	Porcelain tiles - Wall Tiles
MARBLE LOOK	300	MARVEL GEMS	Porcelain tiles
	302	MARVEL PRO	Porcelain tiles - Wall Tiles
	320	MARVEL SHINE	Porcelain tiles - Wall Tiles
	342	MARVEL STONE	Porcelain tiles - Wall Tiles
	356	BRICK ATELIER	Wall Tiles

	360	AIX	Porcelain tiles - Wall Tiles
	372	BRAVE	Porcelain tiles - Wall Tiles
	382	DOLMEN PRO	Porcelain tiles
	390	KLIF	Porcelain tiles - Wall Tiles
STONE LOOK	400	KONE	Porcelain tiles - Wall Tiles
	406	LIMS	Porcelain tiles - Wall Tiles
	418	MARVEL STONE	Porcelain tiles
	424	NORDE	Porcelain tiles
	432	SEASTONE	Porcelain tiles
	438	TRUST	Porcelain tiles

	444	ARBOR	Porcelain tiles
	450	AXI	Porcelain tiles
	458	ETIC	Porcelain tiles
	464	ETIC PRO	Porcelain tiles
WOOD LOOK	470	EXENCE	Porcelain tiles
	478	HEARTWOOD	Porcelain tiles
	484	NASH	Porcelain tiles
	490	NID	Porcelain tiles

	496	GRANIGLIATI	Porcelain tiles
	498	GREENCOLORS	Porcelain tiles
	499	GROUNDTRACK	Porcelain tiles

LARGE SIZES

500

OUTDOOR DESIGN

554

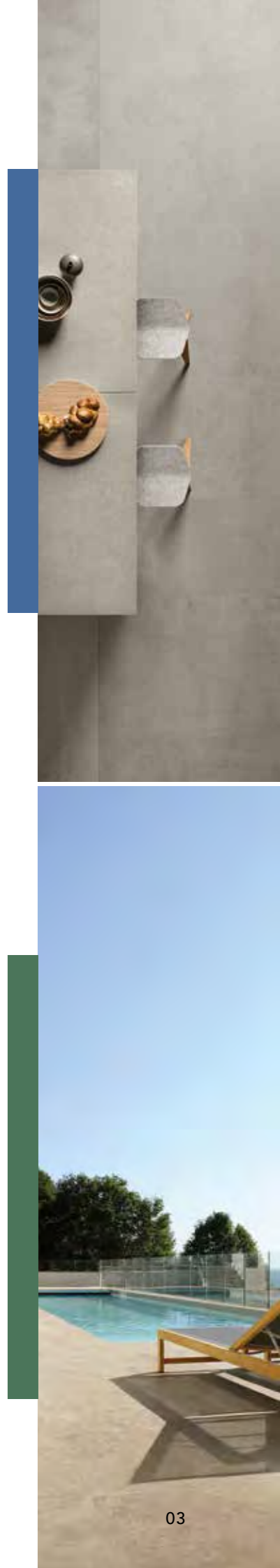

PORCELAIN AND WALL TILES. A SAFE CHOICE.



IT DOES NOT BURN
Non brucia

HYGIENIC
Igienico

RECYCLABLE
Riciclabile

VERSATILE
Versatile

IT LOVES THE ENVIRONMENT
Ama l'ambiente

LONG LASTING
Dura a lungo

SAFE
Sicuro

RESISTANT
Resistente

ZERO PVC
Zero PVC

ZERO VOCS
Zero VOC

GLOBAL DESIGN PARTNER.

We are a **global partner in international design** thanks to our superior ceramic solutions that are innovative in both style and technology. Our extensive range of porcelain surfaces for interiors, exteriors, and ceramic decorative tiles meets all the needs of designers and end users all over the world.

Siamo **partner globali della progettazione e del design internazionali**, grazie a soluzioni ceramiche di eccellenza, innovative per stile e tecnologia. La nostra ampia offerta di superfici in gres porcellanato per interni ed esterni e rivestimenti decorativi in ceramica risponde compiutamente alle esigenze di progettisti e utilizzatori finali ovunque nel mondo.



Nous sommes des partenaires globaux de la planification et de la conception internationales, grâce à d'excellentes solutions en céramique, innovantes dans leur style et leur technologie. Notre vaste gamme de surfaces en grès cérame pour l'intérieur et l'extérieur et de revêtements céramiques décoratifs répond aux besoins des concepteurs et des utilisateurs finaux dans le monde entier.

Wir sind anhand hochwertiger und aufgrund ihres Stil und ihrer Technologie innovativer Keramikprodukte globale Partner für die internationale Planung und das internationale Design. Unser breites Angebot an Feinsteinzeugoberflächen für den Innen- und Außenbereich sowie an dekorativen keramischen Bodenfliesen wird den Bedürfnissen von Planern und Endverbrauchern auf der ganzen Welt gerecht.

Somos socios globales en el diseño y la planificación internacional, gracias a excelentes soluciones cerámicas, innovadoras en estilo y tecnología. Nuestra amplia gama de superficies de gres porcelánico para interiores y exteriores y revestimientos cerámicos decorativos satisface plenamente las necesidades de diseñadores y usuarios finales en todo el mundo.

Мы глобальные партнеры в сфере проектирования и дизайна, потому что предлагаем превосходную плитку, инновационную по стилю и технологиям. Наш керамогранит для интерьера и улицы и декоративная настенная плитка в состоянии исчерпывающе удовлетворить любые требования проектировщиков и потребителей, в какой бы части света они ни находились.



TIME IS ON OUR SIDE.

Our company was founded in 1969, and **today, more than 50 years later**, we continue to passionately experience the authentic spirit of a history that continuously renews itself while remaining faithful to our core values, like innovation, technology, ethics and social and environmental sustainability.

La nostra azienda nasce nel 1969 e **oggi, dopo oltre 50 anni**, continuiamo a vivere con passione lo spirito più autentico di una storia che sa rinnovarsi di continuo, pur rimanendo fedele ai valori che ne hanno accompagnato il cammino, come l'innovazione, la tecnologia, l'etica e la sostenibilità sociale e ambientale.

Notre société a été fondée en 1969 et aujourd'hui, après plus de 50 ans, nous continuons à vivre avec passion l'esprit le plus authentique d'une histoire qui sait se renouveler sans cesse, tout en restant fidèle aux valeurs qui ont accompagné notre parcours, telles que l'innovation, la technologie, l'éthique et la durabilité sociale et environnementale.

Nuestra empresa fue fundada en 1969 y hoy, después de más de 50 años, seguimos viviendo con pasión el espíritu más auténtico de una historia que sabe renovarse continuamente, manteniéndose fiel a los valores que han acompañado su camino, como la innovación, la tecnología, la ética y la sostenibilidad social y ambiental.

Unser Unternehmen wurde 1969 gegründet und auch heute, nach mehr als 50 Jahren, verfolgen wir weiterhin mit Leidenschaft den authentischsten Geist einer Geschichte, die sich ständig erneuert und dabei den Werten treu bleibt, die sie auf ihrem Weg begleitet haben, wie Innovation, Technologie, Ethik sowie soziale und ökologische Nachhaltigkeit.

Наша компания была основана в 1969 году, и сегодня, спустя более 50 лет, мы с тем же энтузиазмом ищем новых достижений, оставаясь при этом верными нашим исконным ценностям, таким как инновации, технологии, этика, социальная ответственность, экологичность.

1969 — 1974 — 1990 — 1998 — 2005 — 2016 — 2018 — 2020

CERAMICHE CONCORDE FOUNDATION

Fondazione di Ceramiche Concorde

ATLAS CERAMICHE FOUNDATION

Fondazione di Atlas Ceramiche

CERAMICHE ATLAS CONCORDE FOUNDATION

Fondazione di Ceramiche Atlas Concorde

PORCELAIN TILE PRODUCTION STARTS

Inizia la produzione di gres porcellanato

ATLAS CONCORDE RUSSIA WAS BORN

Nasce Atlas Concorde Russia

ATLAS CONCORDE USA WAS BORN

Nasce Atlas Concorde Usa

ATLAS PLAN LAUNCH

Lancio del brand Atlas Plan

NEW LOGISTIC CENTER

Nuovo polo logistico

FACTORY REACHES 100% ENERGETIC AUTO SUFFICIENCY

Lo stabilimento produttivo raggiunge il 100% di autosufficienza energetica

AUTHENTIC INSPIRATION.

To create a new collection, we seek out the most original sources of inspiration wherever they may be. The rarest stones and marbles, the most authentic woods, and the surfaces that best reflect a contemporary character are interpreted until an innovative material of **absolute excellence and quality** is achieved, fully conveying the meaning and style of **Made in Italy** throughout the world.

Per realizzare una nuova collezione, cerchiamo le ispirazioni più originali ovunque si trovino. Le pietre e i marmi più rari, il legno più autentico, le superfici che meglio identificano la contemporaneità sono interpretate fino a ottenere un materiale innovativo e di **assoluta eccellenza e qualità**, che rispecchi al 100% il significato e lo stile del **Made in Italy** nel mondo.



Pour créer une nouvelle collection, nous recherchons les inspirations les plus originales où qu'elles se trouvent. Les pierres et les marbres les plus rares, le bois le plus authentique, les surfaces qui identifient le mieux notre temps sont interprétés pour obtenir un matériau innovant d'une excellence et d'une qualité absolues, qui reflète à 100% le sens et le style du Made in Italy dans le monde.

Para crear una nueva colección, buscamos las inspiraciones más originales dondequiera que estén. Las piedras y los mármoles más raros, la madera más auténtica, las superficies que mejor identifican lo contemporáneo se interpretan para obtener un material innovador y de absoluta excelencia y calidad, que refleje al 100% el significado y el estilo del Made in Italy en el mundo.

Für den Entwurf einer neuen Kollektion suchen wir nach den originellsten Inspirationen, wo auch immer diese zu finden sind. Die seltensten Steine und Marmore, das echteste Holz und die die zeitgenössische Welt am besten verkörpernden Oberflächen werden für den Erhalt eines innovativen Materials von vollkommener Vortrefflichkeit und Qualität interpretiert, das zu 100% die Bedeutung und den Stil des Made in Italy weltweit widerspiegelt.

Чтобы создать новую коллекцию, мы ищем самые интересные источники вдохновения, где бы они ни находились. Редкие камни и сорта мрамора, традиционные породы древесины, современные индустриальные материалы переосмысливаются нашими дизайнерами до тех пор, пока не получится тот материал, который на 100% воплотит столь высоко ценимый во всем мире итальянский стиль.



PERMANENT INNOVATION.

At Atlas Concorde the most advanced systems are complemented by an extensive expertise in ceramic tiles rich in experience and quality. **Process innovation is permanent** and oriented towards industrial efficiency, with consequent positive effects on the product and service, as demonstrated by the new logistics hub, which completes the fully automated and digitized production.

In Atlas Concorde l'impiantistica più avanzata è al servizio di un sapere ceramico forte e ricco di esperienza e qualità. **L'innovazione di processo è permanente** e orientata a un efficientamento industriale con effetti positivi sul prodotto e sul servizio, come dimostra il nuovo polo logistico, che completa una efficacia produttiva di eccellenza completamente automatizzata e digitalizzata.

Chez Atlas Concorde, les installations les plus avancées sont au service d'un savoir-faire céramique solide, riche en expérience et en qualité. L'innovation de processus est permanente et orientée vers l'efficacité industrielle avec des effets positifs sur le produit et le service, comme le démontre le nouveau centre logistique, qui complète un parcours de production d'excellence, entièrement automatisé et numérisé.

Bei Atlas Concorde steht die modernste Anlagentechnik im Dienst eines durch Erfahrung gestärkten und mittels Qualität bereicherten keramischen Know-hows. Die Prozessinnovation ist permanent und mit positiven Auswirkungen auf das Produkt und den Service auf die industrielle Effizienz ausgerichtet, wie der neue Logistik-Hub zeigt, der eine vollautomatisierte und digitalisierte Produktionseffizienz der Spitzenklasse vervollständigt.

En Atlas Concorde, la más avanzada ingeniería de plantas está al servicio de un fuerte conocimiento de la cerámica, rico en experiencia y calidad. La innovación de procesos es permanente y está orientada hacia la eficiencia industrial con efectos positivos en el producto y el servicio, como lo demuestra el nuevo centro logístico, que completa una eficiencia productiva de excelencia totalmente automatizada y digitalizada.

На полностью автоматизированных и оцифрованных заводах Atlas Concorde передовое производственное оборудование – на службе у глубоких знаний и опыта в области керамики. Здесь технологические инновации носят постоянный характер и направлены на совершенствование как самого процесса производства, так и выпускаемых изделий и обслуживания, о чем свидетельствует, например, новая логистическая платформа.





ASILO CONCORDE



Notre responsabilité sociétale se traduit par des faits concrets, comme l'autonomie énergétique de l'usine de Fiorano Modenese, obtenue grâce à une centrale de cogénération au méthane et à la récupération des eaux et des déchets de traitement. Elle s'exprime également par l'attention portée à la sécurité et au bien-être des travailleurs, qui peuvent bénéficier de cours de formation et de services exclusifs, comme l'Asilo Concorde, un centre pédagogique qualifié ouvert aux enfants des salariés.

Nuestra responsabilidad social se expresa en hechos concretos, como la autonomía energética de la planta de Fiorano Modenese, obtenida gracias a una planta de cogeneración de metano y a la recuperación de agua y procesamiento de residuos de elaboración. También se expresa en la atención prestada a la seguridad y el bienestar de los trabajadores, que pueden realizar cursos y hacer uso de servicios exclusivos, como la guardería infantil Asilo Concorde, una estructura pedagógica cualificada abierta a los hijos de los empleados.

Unsere soziale Verantwortung drückt sich in konkreten Fakten aus, wie z.B. der Energieautonomie der Werkanlage in Fiorano Modenese, die auf einer mit Methan betriebenen Kraft-Wärme-Kopplungsanlage und der Aufbereitung von Wasser und Verarbeitungsabfällen beruht. Sie drückt sich auch durch Aufmerksamkeit auf die Sicherheit und das Wohlbefinden der Mitarbeiter aus. Diese können Schulungen und exklusive Dienstleistungen in Anspruch nehmen, wie zum Beispiel das Asilo Concorde, eine qualifizierte pädagogische Struktur, die den Kindern aller Mitarbeiter offen steht.

Наша социальная ответственность проявляется в конкретных фактах. Благодаря работающей на метане когенерационной установке завод в Фьорано-Моденезе достиг энергетической независимости. Кроме того, оснащён современной системой повторного использования отработанной воды и отходов производства. Не меньше внимания уделяется благополучию работников. Для них организуется непрерывное обучение по вопросам безопасности и повышения профессиональных навыков. А чтобы помочь им с организацией семейной жизни, мы открыли для их детей детский Asilo Concorde.

WE CARE.

Our social responsibility is expressed in concrete facts, like the energy autonomy of the plant in Fiorano Modenese, achieved thanks to a methane cogeneration system and the recovery of water and waste. It's also evident in our attention to the safety and welfare of our workers, who enjoy exclusive training courses and services such as the **Asilo Concorde**, a qualified nursery school available for the children of employees.

La nostra responsabilità sociale si esprime in fatti concreti, come l'autonomia energetica dello stabilimento di Fiorano Modenese, ottenuta grazie a un impianto di cogenerazione a metano e al recupero delle acque e degli scarti di lavorazione. Si esprime anche con l'attenzione alla sicurezza e al benessere dei lavoratori, che possono avvalersi di percorsi di formazione e servizi esclusivi, come l'**Asilo Concorde**, una struttura pedagogica qualificata e aperta ai figli dei dipendenti.



THE WORLD IS OUR HOME.

FRANKLIN (TN)
USA HEADQUARTER
Sede centrale USA

FIORANO MODENESE
MAIN HEADQUARTER
Sede principale

FINALE EMILIA, Italy
ATLAS CONCORDE FACTORY
Stabilimento produttivo Atlas Concorde

MOSCOW
RUSSIA HEADQUARTER
Sede centrale RUSSIA

BRANCHES IN 120 COUNTRIES
Sedi in 120 Paesi del mondo

COMMERCIAL OFFICES
Uffici commerciali

DANIA BEACH, FLORIDA USA	KIEV, UKRAINE
LONDON, UK	STRIPE, LATVIA
LIONE, FRANCE	DUBAI, UAE
PARIS, FRANCE	BEIJING, CHINA
SAINT PETERSBURG, RUSSIA	SEOUL, SOUTH KOREA

Atlas Concorde is a **multinational company** with two production plants in Italy, one in the United States, and one in Russia, as well as showrooms and commercial branches on five continents. Management is solidly rooted in Italy, with headquarters in Fiorano Modenese, in the heart of the world's most important ceramic tile district.

Atlas Concorde è una **realità multinazionale** con due stabilimenti produttivi in Italia, uno negli Stati Uniti e uno in Russia, oltre a showroom e filiali commerciali nei cinque continenti. La governance è saldamente italiana, con quartier generale a Fiorano Modenese, nel cuore del distretto ceramico più importante al mondo.

Atlas Concorde est une réalité multinationale avec deux sites de production en Italie, un aux États-Unis et un autre en Russie, ainsi que des salles d'exposition et des succursales de vente sur les cinq continents. La gouvernance est résolument italienne, avec son quartier général à Fiorano Modenese, au cœur du plus important district céramique du monde.

Atlas Concorde ist ein multinationales Unternehmen mit zwei Produktionsstätten in Italien, eine in den Vereinigten Staaten und eine in Russland sowie Ausstellungsräumen und Verkaufsniederlassungen auf fünf Kontinenten. Die Unternehmensführung ruht fest in italienischer Hand, mit Hauptsitz in Fiorano Modenese, im Herzen des wichtigsten Keramikbezirks der Welt.

Atlas Concorde es una empresa multinacional con dos plantas de producción en Italia, una en Estados Unidos y otra en Rusia, así como salas de exposición y sucursales de venta en los cinco continentes. Su gobernanza es firmemente italiana, con sede en Fiorano Modenese, en el corazón del distrito cerámico más importante del mundo.

Atlas Concorde – международная реалья. Располагает двумя заводами в Италии, одним в Соединенных Штатах и одним в России, а также шоу-румами, представительствами и филиалами на всех 5-ти континентах. Штаб-квартира компании находится в Италии, в Фьорано-Моденезе, т.е. в самом сердце крупнейшего в мире керамического района.

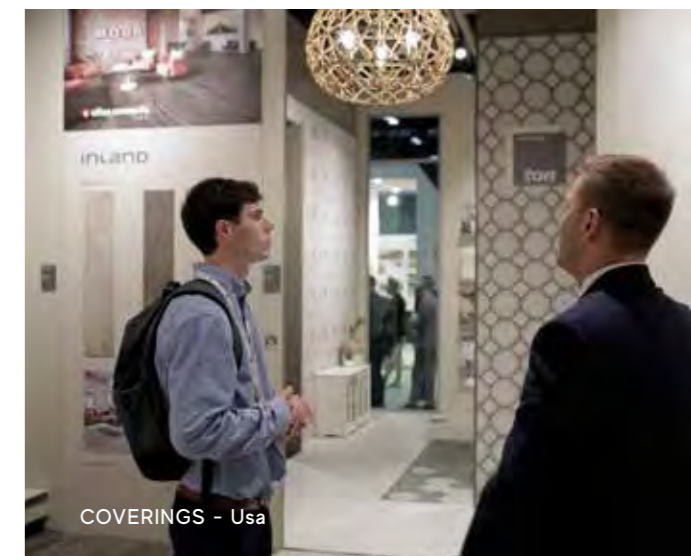

COVERINGS - Usa



CERSAIE - Italy



HEADQUARTER SHOWROOM
Fiorano Modenese



FIORANO MODENESE,
ITALY



OUR SHOWROOMS.

Atlas Concorde has embarked on a **strategy of visibility and physical presence** in the main international design hotspots by opening showrooms and commercial locations that can support the best architects, interior designers, and customers in their work thanks to specialized consulting for each project.

Atlas Concorde ha intrapreso una **strategia di visibilità e presenza** nei principali hotspot internazionali della progettazione, con l'apertura di showroom e sedi commerciali in grado di supportare al meglio architetti, interior designer e clienti nel loro lavoro, grazie a una consulenza specializzata per ogni progetto.

Atlas Concorde a mis en place une stratégie de visibilité et de participation dans les principaux points chauds du design international, avec l'ouverture de showrooms et de bureaux commerciaux capables d'accompagner les architectes, les décorateurs d'intérieur et les clients dans leur travail, grâce à un conseil spécialisé pour chaque projet.

Atlas Concorde verfolgt anhand der Eröffnung von Showrooms und Handelsbüros, die in der Lage sind, mittels einer spezialisierten Beratung für jedes Projekt Architekten, Innenarchitekten und Kunden bei ihrer Arbeit zu unterstützen, eine Strategie der Sichtbarkeit und Präsenz an den wichtigsten internationalen Hotspots der Planung.

Atlas Concorde ha emprendido una estrategia de visibilidad y presencia en los principales puntos neurálgicos del diseño internacional, con la apertura de salas de exposición y oficinas comerciales capaces de apoyar a arquitectos, diseñadores de interiores y clientes en su trabajo, gracias a una asesoría especializada para cada proyecto.

Чтобы установить более тесные отношения со своими партнерами, компания Atlas Concorde разработала стратегию по открытию монобрендовых точек продажи в крупнейших мировых центрах архитектуры и дизайна. В открывшихся шоу-румах к услугам архитекторов, дизайнеров и клиентов широкий ассортимент выставленных коллекций и консультации наших специалистов по применению изделий в различных проектах.



FRANKLIN,
TN, USA

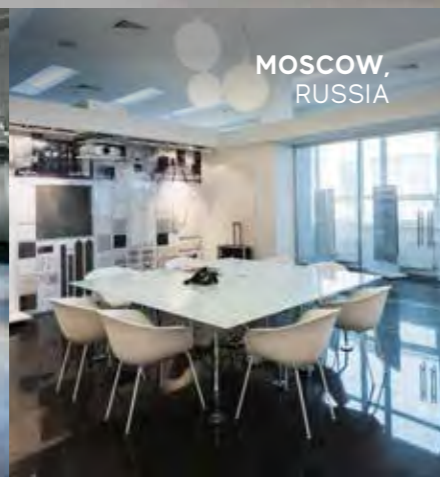

MOSCOW,
RUSSIA



PARIS | LYON,
FRANCE

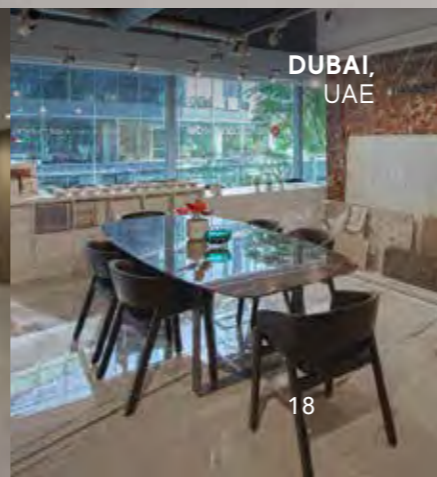

DUBAI,
UAE



AT THE CENTER OF DESIGN.

The new flagship store in Milan, in the key district of Brera, confirms our desire for a **lasting presence in the world of international design**. Designed by Lissoni & Partners, the showroom is an art gallery where ceramic surfaces are displayed in all their beauty, aesthetic, and technological excellence, an ideal setting for the work and meetings of architects, interior designers, and end users.

Il nuovo flagship store di Milano, nel centralissimo quartiere di Brera, conferma la volontà di una **presenza stabile nel mondo del design internazionale**. Progettata da Lissoni & Partners, la sala mostra si pone come una galleria d'arte dove le superfici ceramiche sono esposte in tutta la loro bellezza ed eccellenza estetica e tecnologica, in un contesto ideale per il lavoro e l'incontro di architetti, interior designer e utenti finali.

Le nouveau magasin phare de Milan, dans le quartier central de Brera, confirme la volonté d'une présence stable dans le monde du design international. Conçu par Lissoni & Partners, le showroom se présente comme une galerie d'art où les surfaces céramiques sont exposées dans toute leur beauté et leur excellence esthétique et technologique, dans un contexte idéal pour que les architectes, les décorateurs d'intérieur et les utilisateurs finaux puissent œuvrer et se rencontrer.

Der neue Flagship-Store in Mailand, im zentralen Stadtteil Brera, beweist das Streben nach einer stabilen Präsenz im Bereich des internationalen Designs. Der von Lissoni & Partners entworfene Showroom fungiert als Kunstgalerie, in der die Keramikoberflächen in einem idealen Rahmen für die Arbeit und Begegnung von Architekten, Innenarchitekten und Endverbraucher in ihrer ganzen Schönheit und ästhetischen sowie technologischen Vortrefflichkeit ausgestellt werden.

La nueva tienda insignia de Milán, en el céntrico barrio de Brera, confirma el deseo de una presencia estable en el mundo del diseño internacional. Diseñada por Lissoni & Partners, la sala de exposición se presenta como una galería de arte donde las superficies cerámicas están expuestas en su máximo esplendor y excelencia estética y tecnológica, en un contexto ideal para el trabajo y el encuentro de arquitectos, diseñadores de interiores y usuarios finales.

Новый флагманский магазин в Милане, в сердце квартала Брера, подтверждает наше стремление к стабильному присутствию на международной арене дизайна. Шоу-рум, спроектированный студией Lissoni & Partners, похож на художественную галерею, в которой плитка выставлена во всем своем эстетическом и техническом великолепии. Обстановка здесь идеальна для встреч и совместной работы архитекторов, дизайнеров, конечных потребителей.

ATLAS CONCORDE STUDIO MILANO
by Lissoni & Partners



PROJECTS WORLDWIDE.

The best confirmation of the high regard for our ceramic and porcelain surfaces are the **hundreds of prestigious projects** that architects, interior designers, contractors, and users from around the world complete and enrich with Atlas Concorde materials every year.

La migliore conferma dell'apprezzamento delle nostre superfici ceramiche e in gres porcellanato sono le **centinaia di prestigiose realizzazioni** che ogni anno gli architetti, gli interior designer, i contractor e gli utilizzatori di tutto il mondo completano e arricchiscono con i materiali Atlas Concorde.

La meilleure confirmation de l'appréciation de nos surfaces en céramique et en grès cérame sont les centaines de projets prestigieux que chaque année les architectes, les décorateurs d'intérieur, les entrepreneurs et les utilisateurs du monde entier complètent et enrichissent avec les matériaux d'Atlas Concorde.

Die beste Bestätigung für die Wertschätzung unserer Keramik- und Feinsteinzeugoberflächen sind hunderte prestigeträchtige Projekte, die jedes Jahr von Architekten, Innenarchitekten, Bauunternehmern und Anwendern aus der ganzen Welt mit Materialien von Atlas Concorde vervollständigt und bereichert werden.

La mejor confirmación de la valorización de nuestras superficies de cerámica y gres porcelánico son cientos de prestigiosas creaciones que cada año los arquitectos, diseñadores de interiores, contratistas y usuarios de todo el mundo completan y enriquecen con materiales Atlas Concorde.

Лучшим подтверждением того, насколько высоко ценятся керамогранитные и настенные плитки Atlas Concorde, служат сотни проектов, реализованных с их использованием архитекторами, проектировщиками, интерьерными дизайнерами, строителями, потребителями в самых разных частях света.



WELCOME TO OUR WORLD.

The headquarters in Fiorano Modenese is a **prestigious multifunctional property** where it is pleasant to work and do business. It consists of the office building, a showroom divided into three large exhibition spaces with workshop areas and conference rooms. Situated in a centuries-old park stands the 19th-century Casino Vicini villa along with other welcoming spaces, ideal for business meetings and socializing.

Il quartier generale di Fiorano Modenese è **una prestigiosa sede multifunzionale**, dove è piacevole lavorare e fare business. Si compone della palazzina uffici, una showroom articolata in tre ampie aree espositive, con zone workshop e sale congressi. Immersi in un parco secolare, sorgono la villa ottocentesca di Casino Vicini e altri accoglienti spazi, ideali per gli incontri di lavoro e la socialità.

Le siège de Fiorano Modenese est un lieu multifonctionnel de grand standing, où le travail et les affaires se déroulent dans une ambiance agréable, composée d'un bâtiment destiné aux bureaux, d'une salle d'exposition divisée en trois grands espaces de présentation, avec des zones d'ateliers et des salles de conférence. Immagée dans un parc centenaire, on trouve une villa du XIXe siècle, le Casino Vicini, et d'autres espaces accueillants, idéaux pour les réunions d'affaires et les rencontres sociales.

Der Hauptsitz in Fiorano Modenese ist ein prestigeträchtiger Mehrzweckstandort, an dem es sich angenehm arbeiten und Geschäfte machen lässt. Er besteht aus dem Bürogebäude, einem Ausstellungsraum, der in 3 große Ausstellungsbereiche unterteilt ist, und umfasst Werkstattbereiche sowie Konferenzräume. Inmitten eines jahrhundertealten Parks befinden sich die Villa von Casino Vicini aus dem neunzehnten Jahrhundert und andere einladende Räume, die ideal für Geschäftstreffen und gesellige Zusammenkünfte geeignet sind.

La sede de Fiorano Modenese es una prestigiosa sede multifuncional, donde es agradable trabajar y hacer negocios. Consiste en el edificio de oficinas, una sala de exposición dividida en tres grandes áreas de exhibición, con áreas de talleres y salas de conferencias. Rodeada por un parque centenario, se encuentra la villa del siglo XIX de Casino Vicini y otros acogedores espacios, ideales para reuniones de negocios y socialización.

Штаб-квартира в Фьорано-Моденезе является multifункциональным местом. Состоит из офисного здания и шоу-рума, который включает три выставочные площадки с зонами для семинаров и конференц-залами. Здесь же в старинном парке располагается живописная вилла Casino Vicini XVIII века с комфортными пространствами для работы и отдыха.



PORCELAIN AND WALL TILES: A SAFE CHOICE.

SEE PAGE 572 FOR OTHER LANGUAGES /
VAI A PAGINA 572 PER LE ALTRE LINGUE

1. RESISTANCE AND DURATION

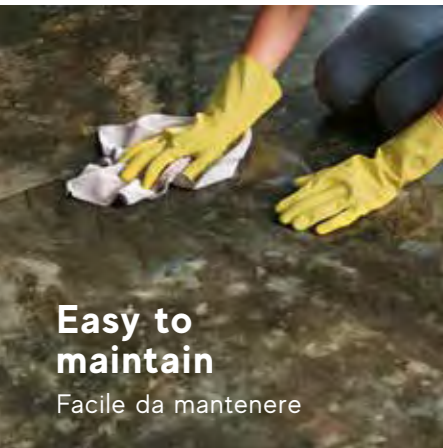

Easy to maintain
Facile da mantenere

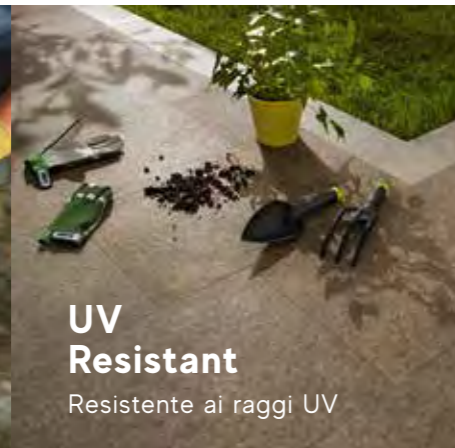

UV Resistant
Resistente ai raggi UV



Scratch resistant
Resistente al graffio

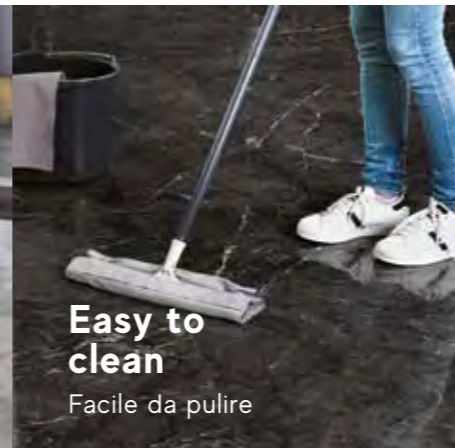

Easy to clean
Facile da pulire



Stain resistant
Resistente alle macchie



Resistant to chemicals
Resistente agli agenti chimici

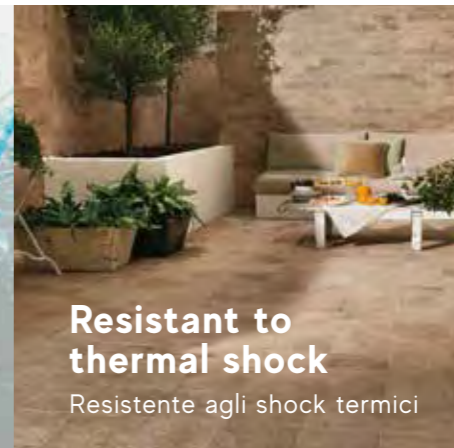

Resistant to thermal shock
Resistente agli shock termici



Resistant to acids
Resistente agli acidi

1.

2. HEALTH

3. SAFETY

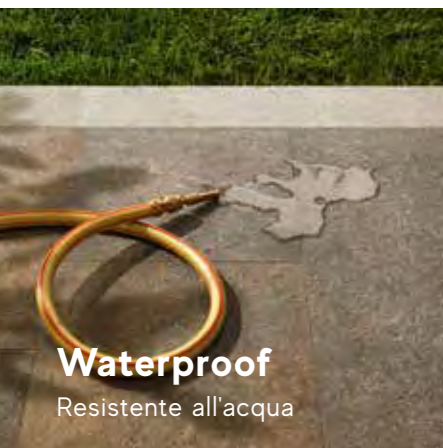

Waterproof
Resistente all'acqua



Frost resistant
Resistente al ghiaccio

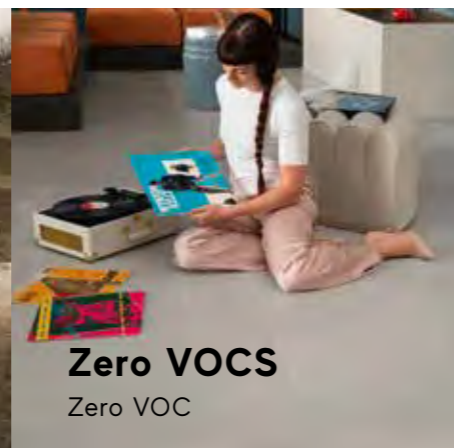

Zero VOCS
Zero VOC



Zero PVC
Zero PVC

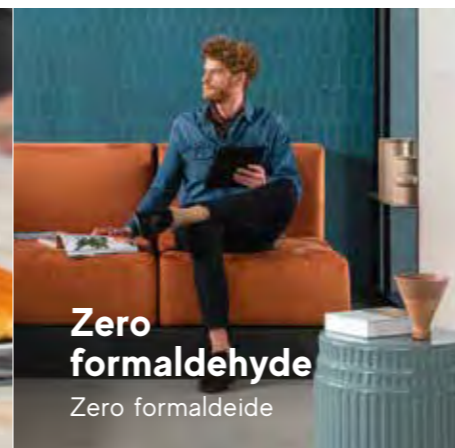

Zero formaldehyde
Zero formaldeide

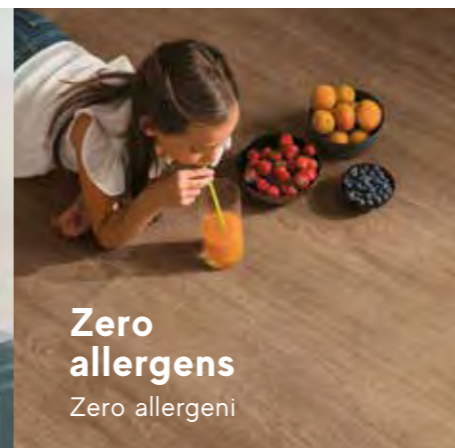

Zero allergens
Zero allergeni



Prevent bacterial growth
Previene la crescita batterica

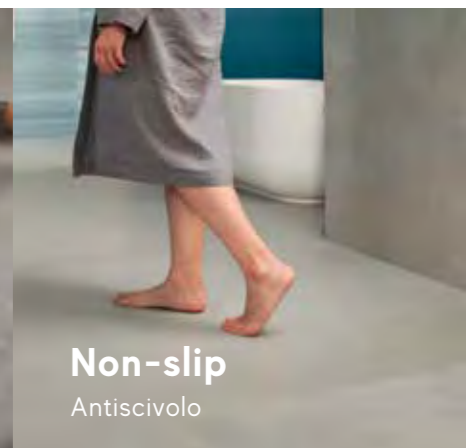

Non-slip
Antiscivolo

3.

4. ENVIRONMENT

5. WALL TILES BENEFITS



Fire resistant
Resistente al fuoco

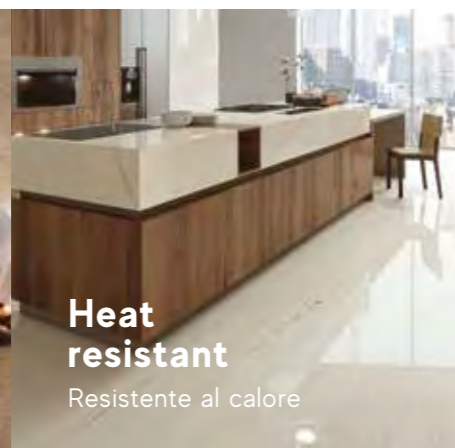

Heat resistant
Resistente al calore



Energy efficiency
Efficienza energetica

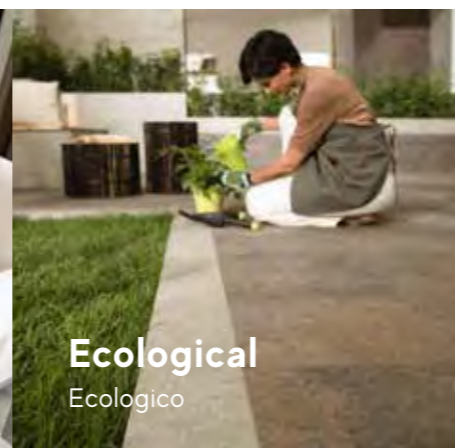

Ecological
Ecologico

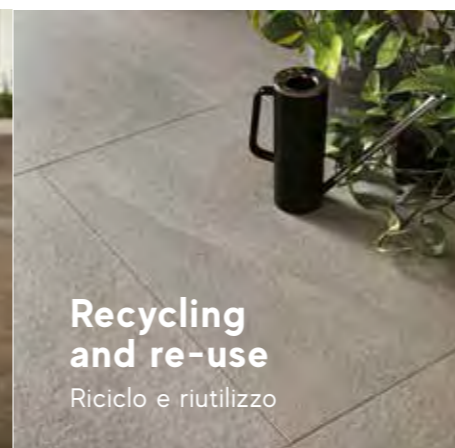

Recycling and re-use
Riciclo e riutilizzo

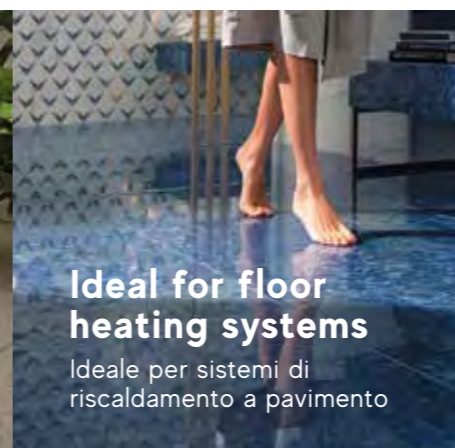

Ideal for floor heating systems
Ideale per sistemi di riscaldamento a pavimento



Ease of installation
Facilità di lavorazione

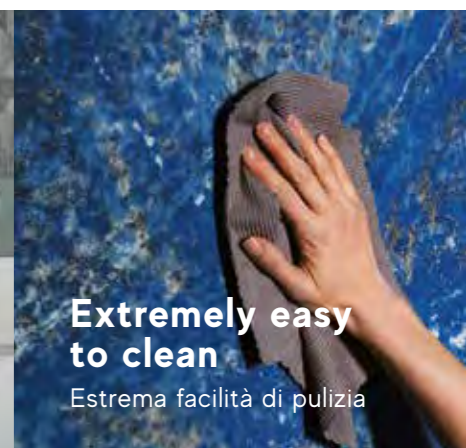

Extremely easy to clean
Estrema facilità di pulizia



Product range sum up

- 30 PORCELAIN TILES
- 48 WALL TILES
- 58 PORCELAIN TILE DECORS
- 86 WALL TILE DECORS

Porcelain tiles | Concrete & Resin Look

Gres porcellanato



PRODUCT RANGE SUM UP | PORCELAIN TILES

PRODUCT RANGE SUM UP | PORCELAIN TILES

Porcelain tiles | Concrete & Resin Look

Gres porcellanato

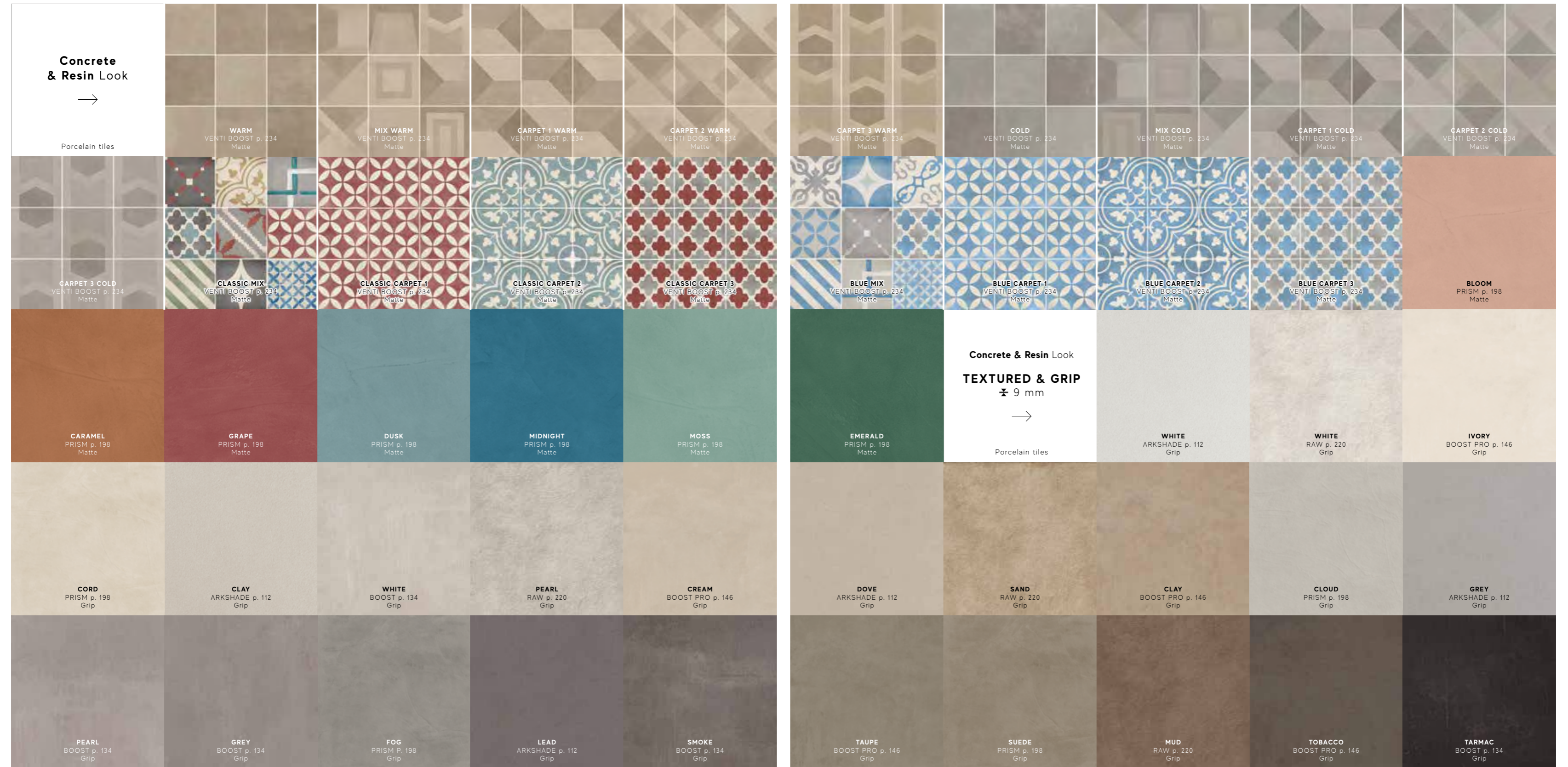

PRODUCT RANGE SUM UP | PORCELAIN TILES

PRODUCT RANGE SUM UP | PORCELAIN TILES

Porcelain tiles | Concrete & Resin Look

Gres porcellanato



PRODUCT RANGE SUM UP | PORCELAIN TILES

PRODUCT RANGE SUM UP | PORCELAIN TILES

Porcelain tiles | Metal Look

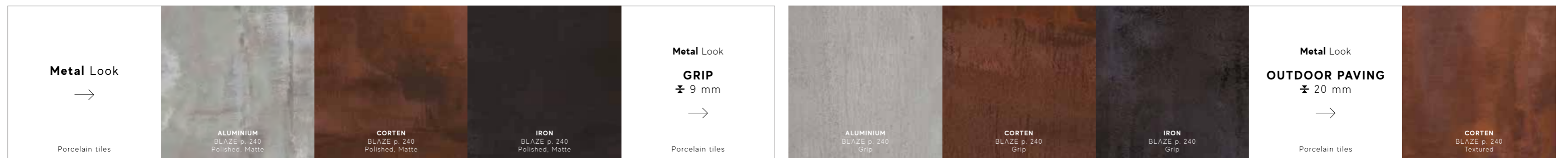

February 2021

Porcelain tiles | Marble Look

Gres porcellanato

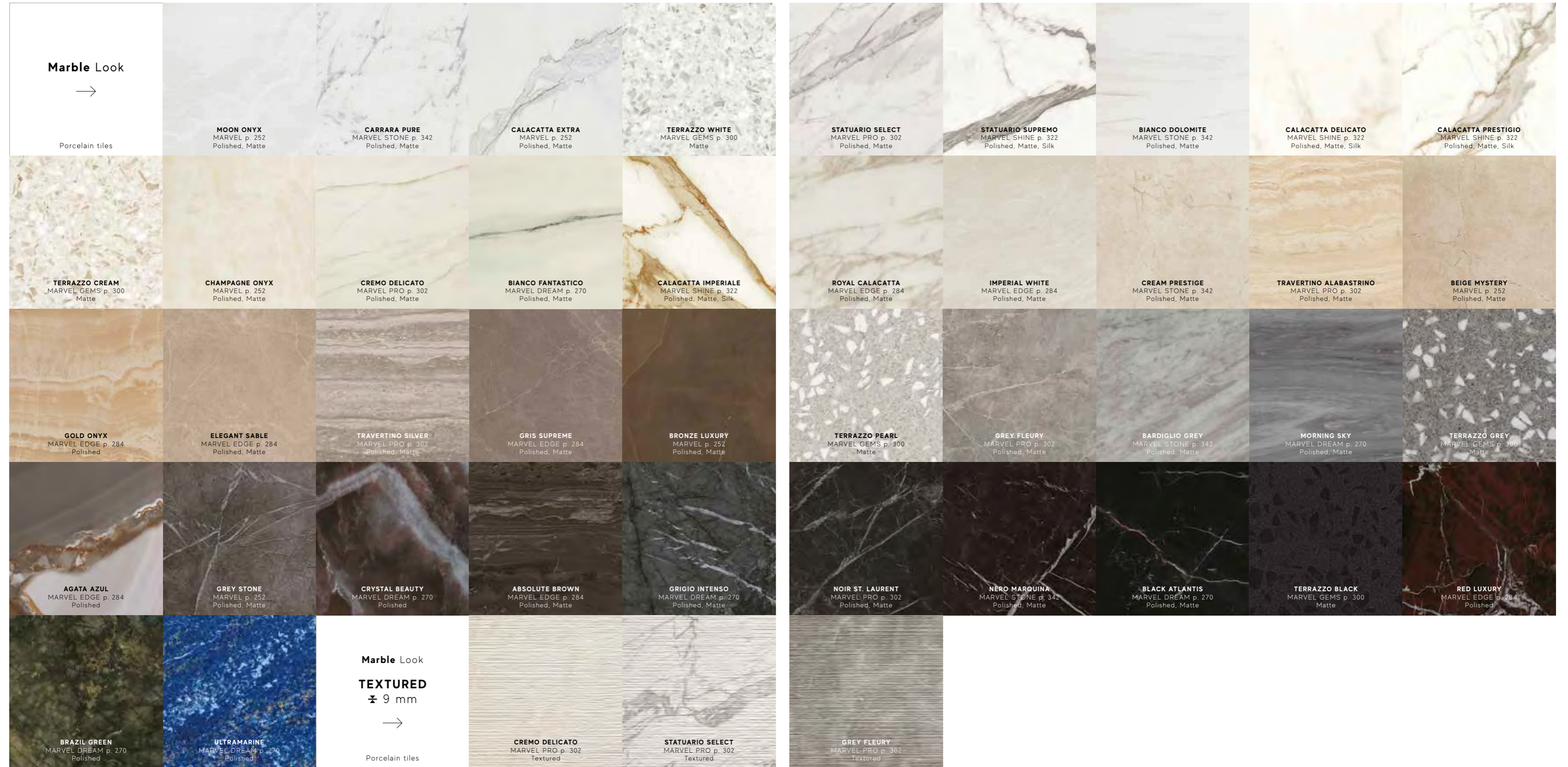

PRODUCT RANGE SUM UP | PORCELAIN TILES

PRODUCT RANGE SUM UP | PORCELAIN TILES

Porcelain tiles | Stone Look

Gres porcellanato



PRODUCT RANGE SUM UP | PORCELAIN TILES

PRODUCT RANGE SUM UP | PORCELAIN TILES

Porcelain tiles | Stone Look

Gres porcellanato



PRODUCT RANGE SUM UP | PORCELAIN TILES

PRODUCT RANGE SUM UP | PORCELAIN TILES



Porcelain tiles | Stone Look

Gres porcellanato

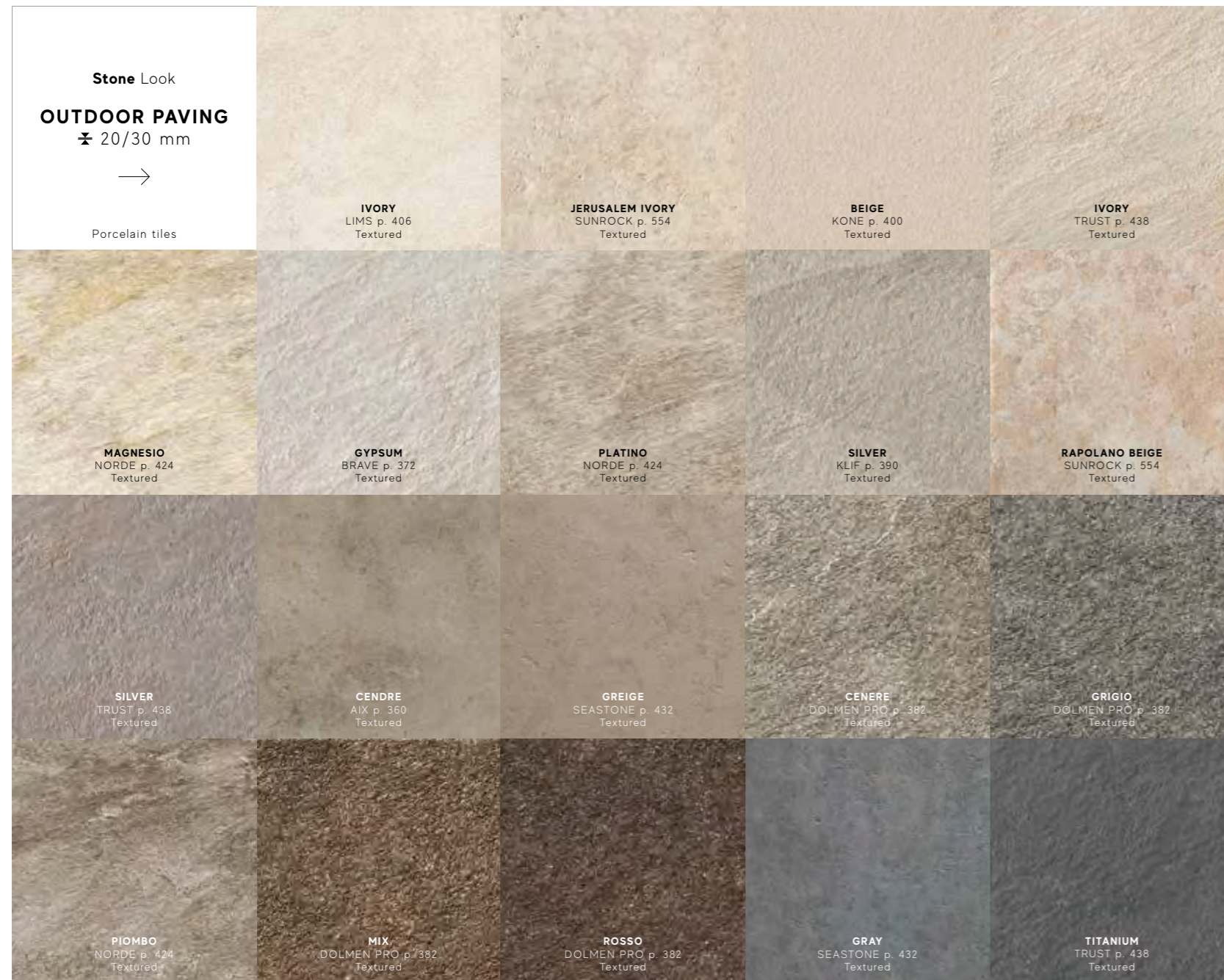

PRODUCT RANGE SUM UP | PORCELAIN TILES

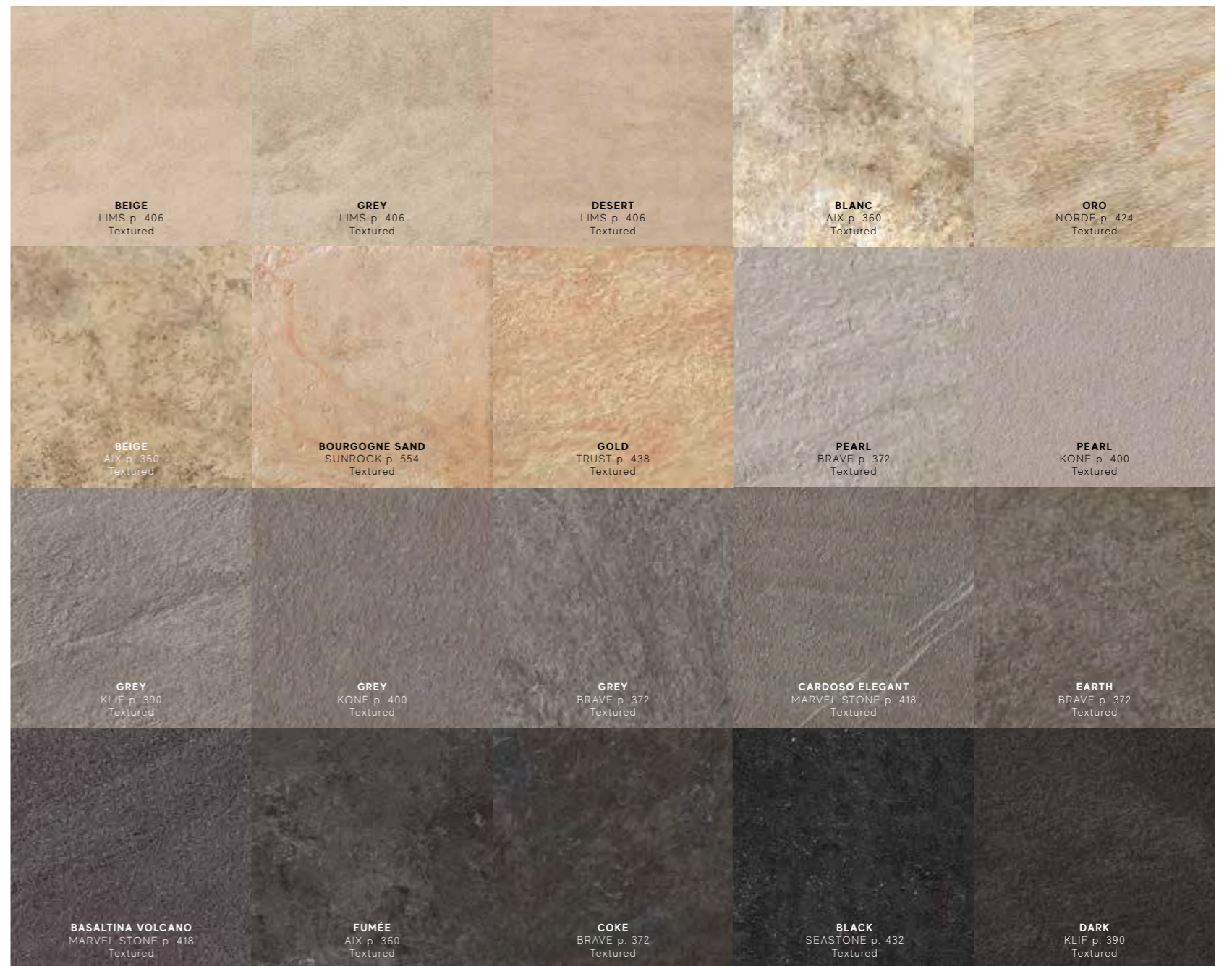

PRODUCT RANGE SUM UP | PORCELAIN TILES

Porcelain tiles | Wood Look

Gres porcellanato

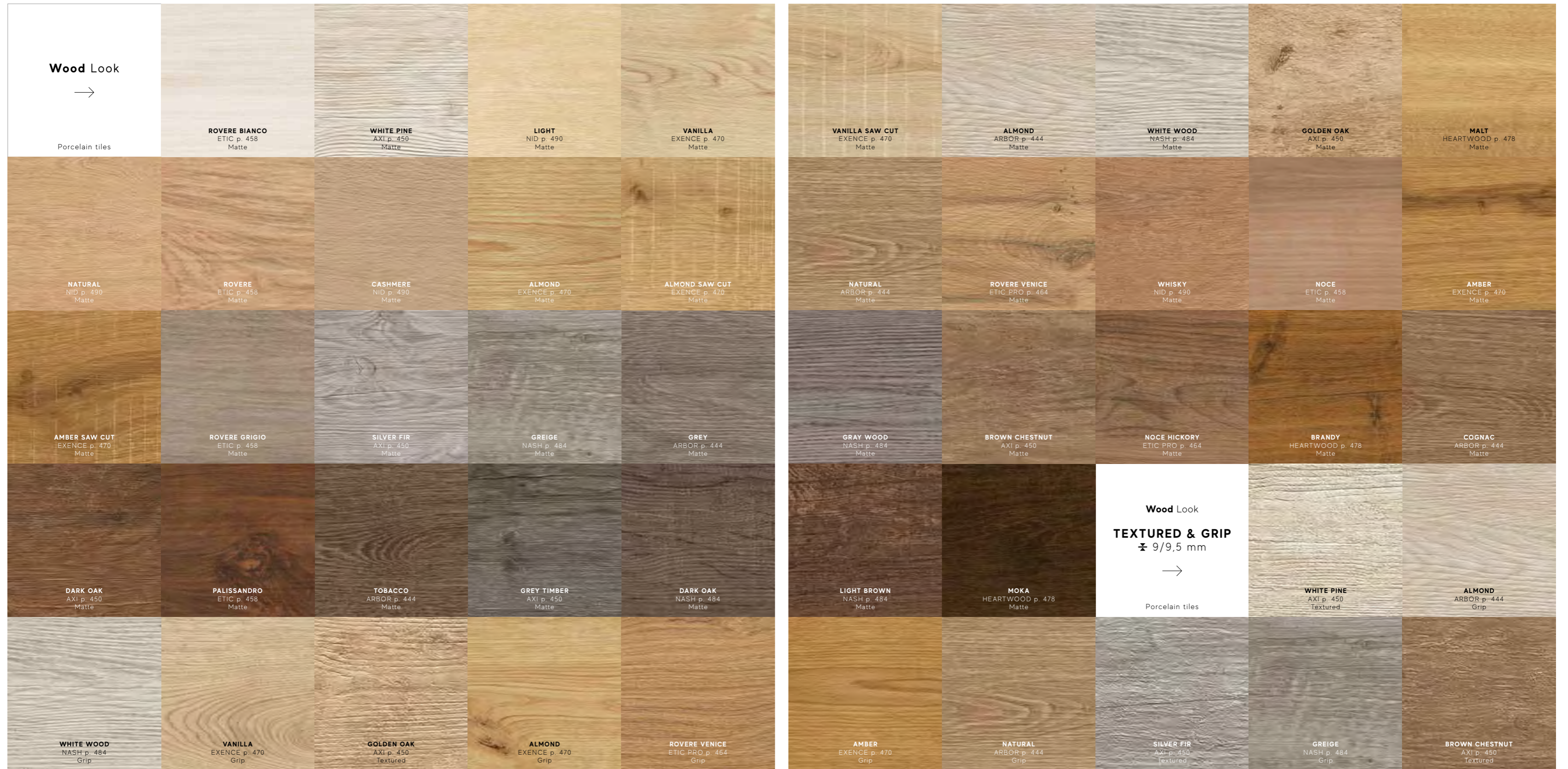

PRODUCT RANGE SUM UP | PORCELAIN TILES

PRODUCT RANGE SUM UP | PORCELAIN TILES

Porcelain tiles | Wood Look

Gres porcellanato

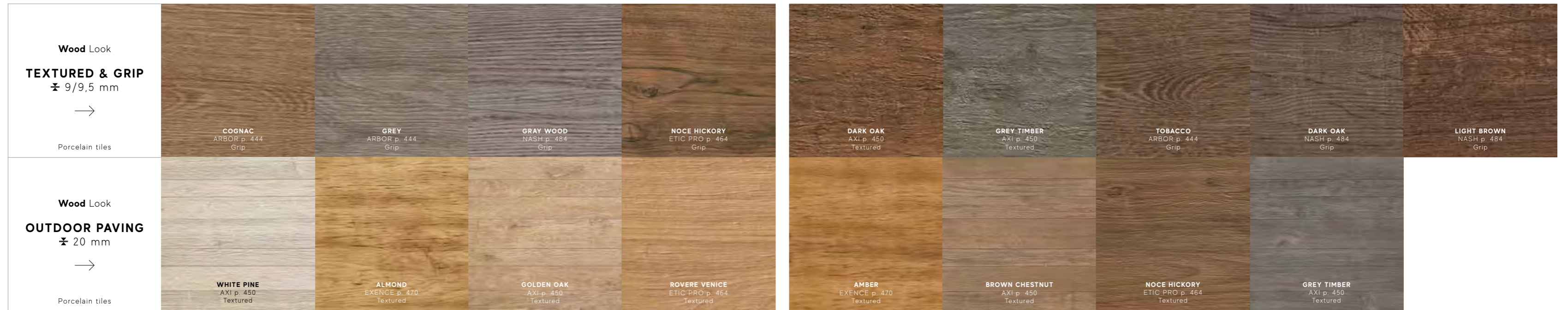

PRODUCT RANGE SUM UP | PORCELAIN TILES

PRODUCT RANGE SUM UP | PORCELAIN TILES

Wall tiles | Concrete & Resin + Metal Look

Rivestimenti



PRODUCT RANGE SUM UP | WALL TILES

PRODUCT RANGE SUM UP | WALL TILES

Wall tiles | Marble Look

Rivestimenti

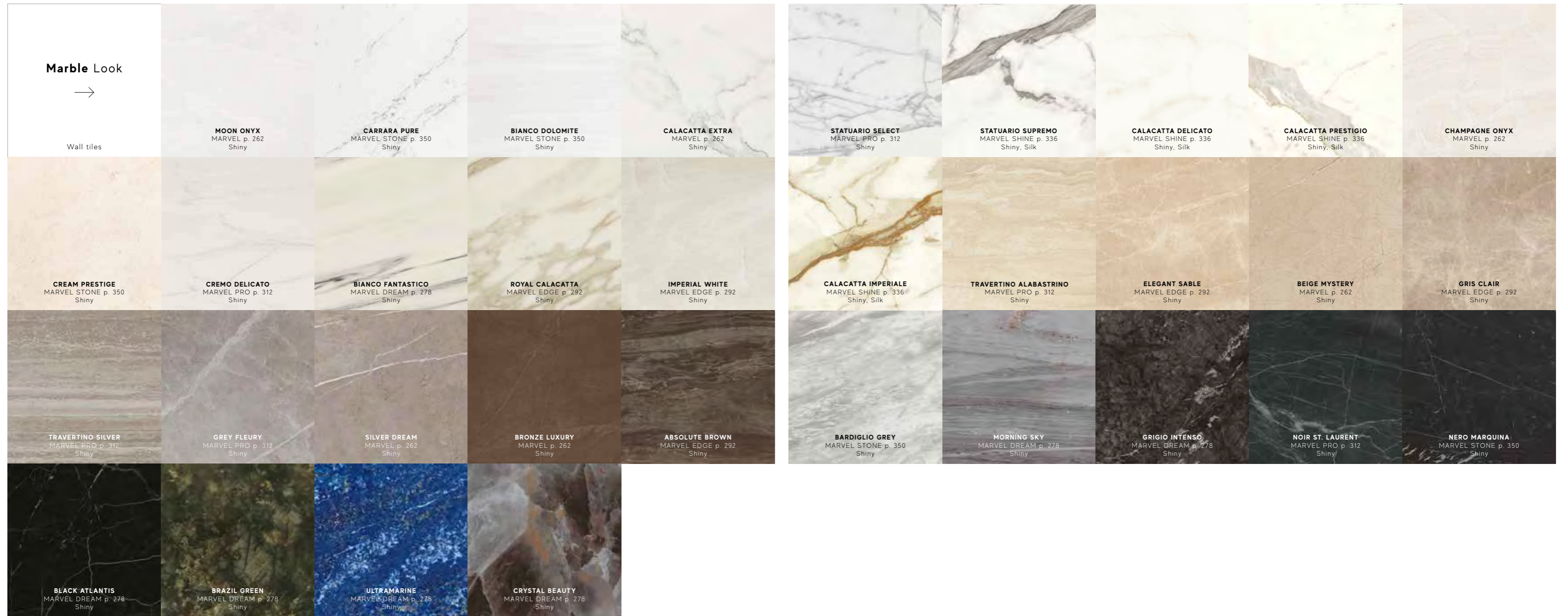

PRODUCT RANGE SUM UP | WALL TILES

PRODUCT RANGE SUM UP | WALL TILES

Wall tiles | Stone Look

Rivestimenti

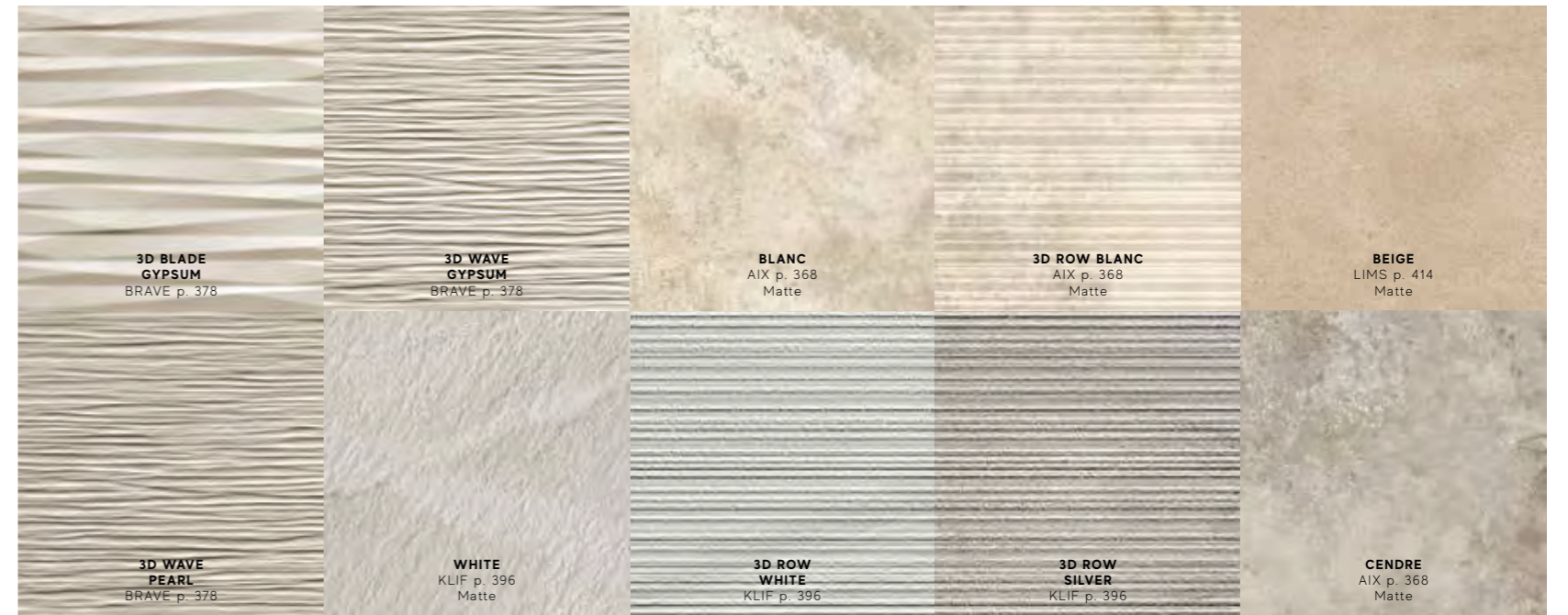

Wall tiles | Color Look

Rivestimenti

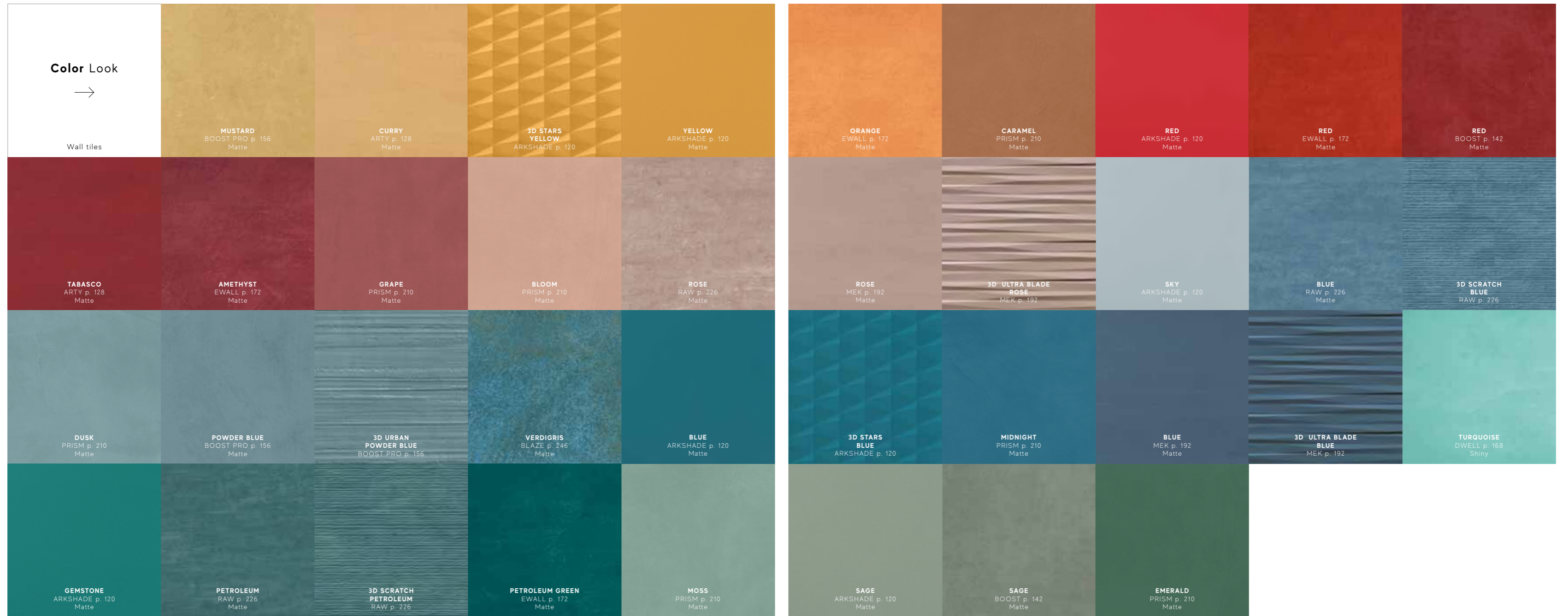

PRODUCT RANGE SUM UP | WALL TILES

PRODUCT RANGE SUM UP | WALL TILES

Wall tiles | 3D Wall Design

Rivestimenti p. 100



PRODUCT RANGE SUM UP | WALL TILES

PRODUCT RANGE SUM UP | WALL TILES

Porcelain tile decors | Concrete & Resin Look

Decori in gres porcellanato

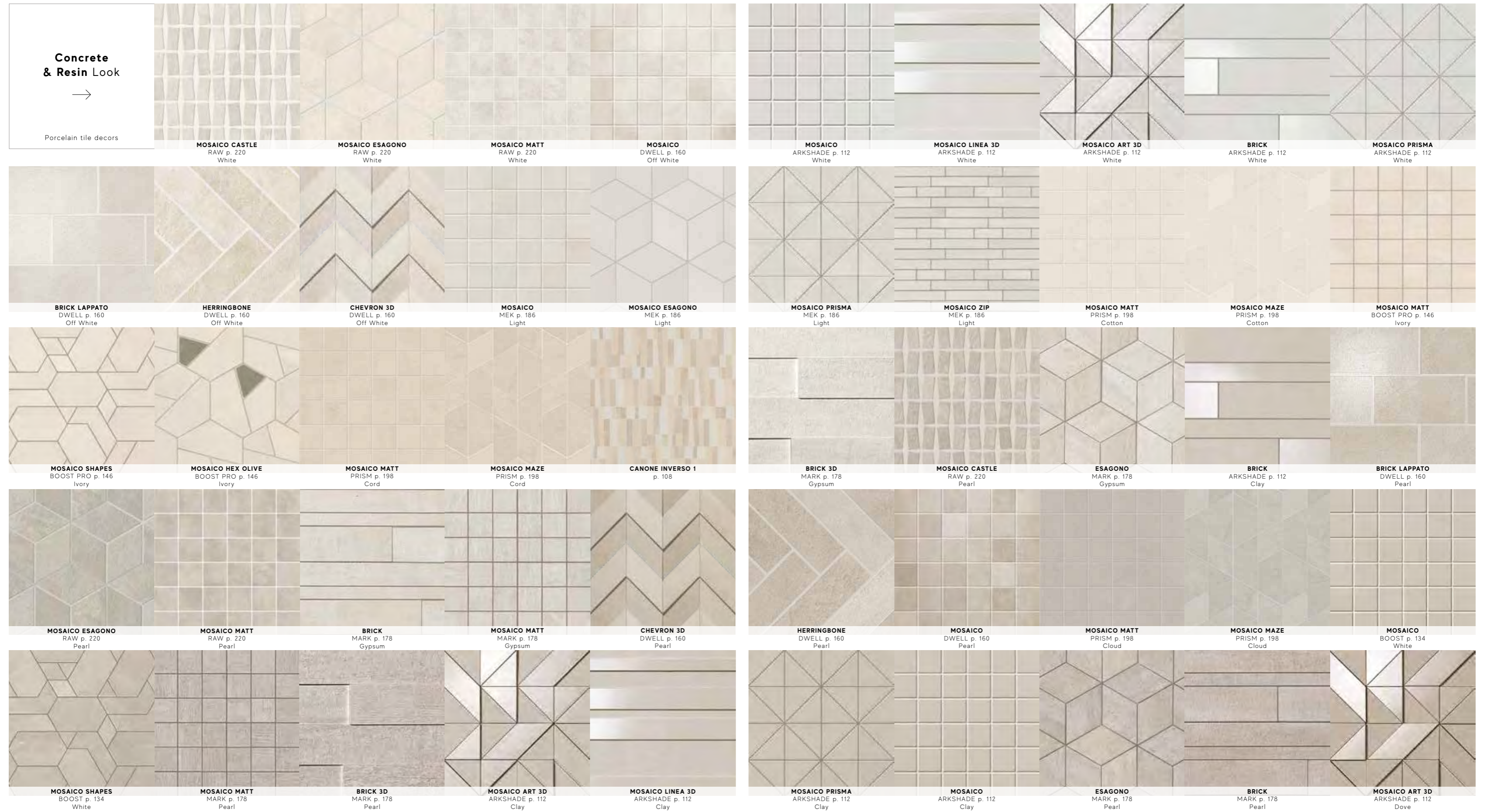

PRODUCT RANGE SUM UP | PORCELAIN TILE DECORS

PRODUCT RANGE SUM UP | PORCELAIN TILE DECORS

Porcelain tile decors | Concrete & Resin Look

Decori in gres porcellanato

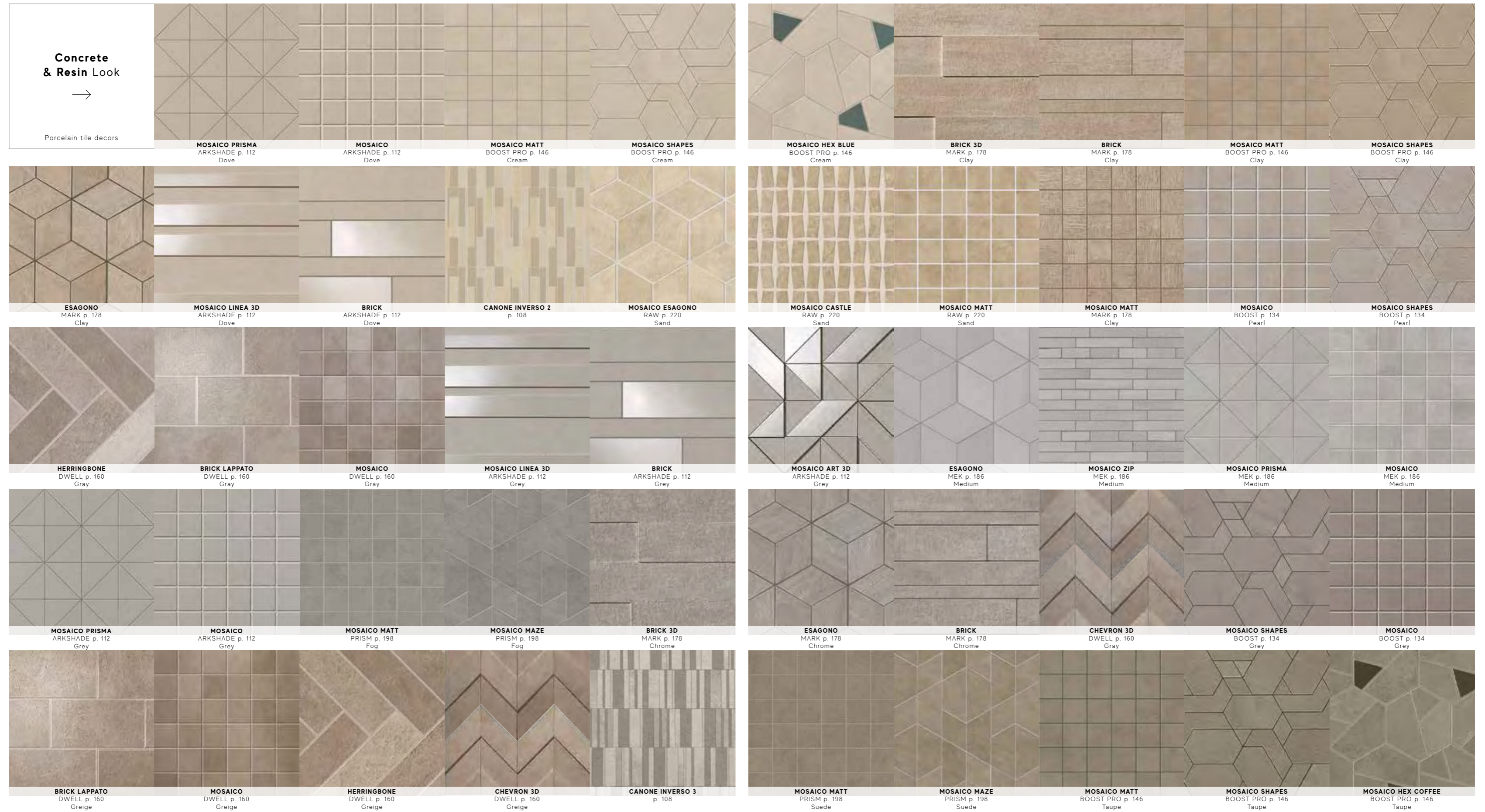

PRODUCT RANGE SUM UP | PORCELAIN TILE DECORS

PRODUCT RANGE SUM UP | PORCELAIN TILE DECORS

Porcelain tile decors | Concrete & Resin Look

Decori in gres porcellanato

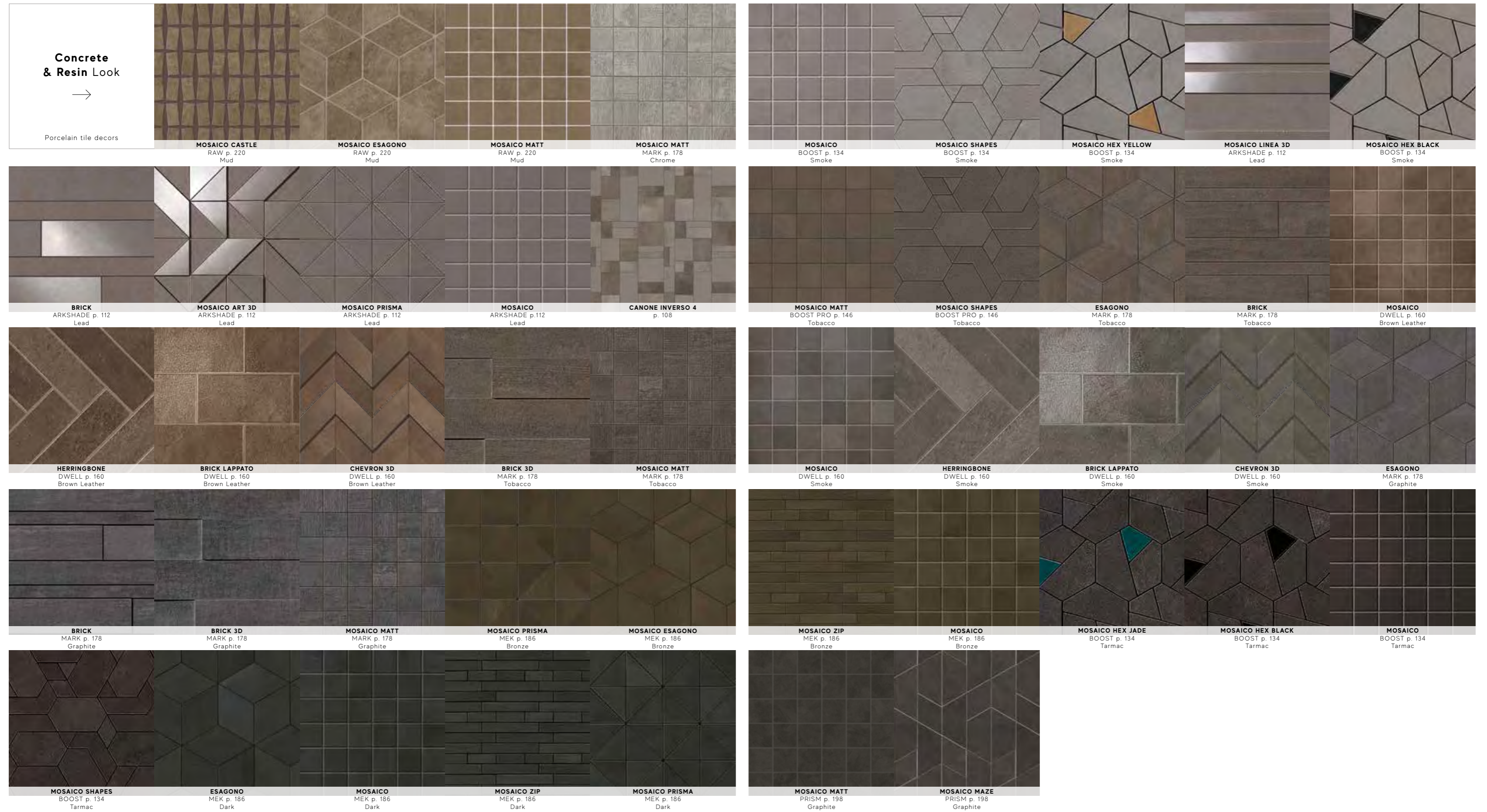

PRODUCT RANGE SUM UP | PORCELAIN TILE DECORS

PRODUCT RANGE SUM UP | PORCELAIN TILE DECORS

Porcelain tile decors | Concrete & Resin Look

Decori in gres porcellanato

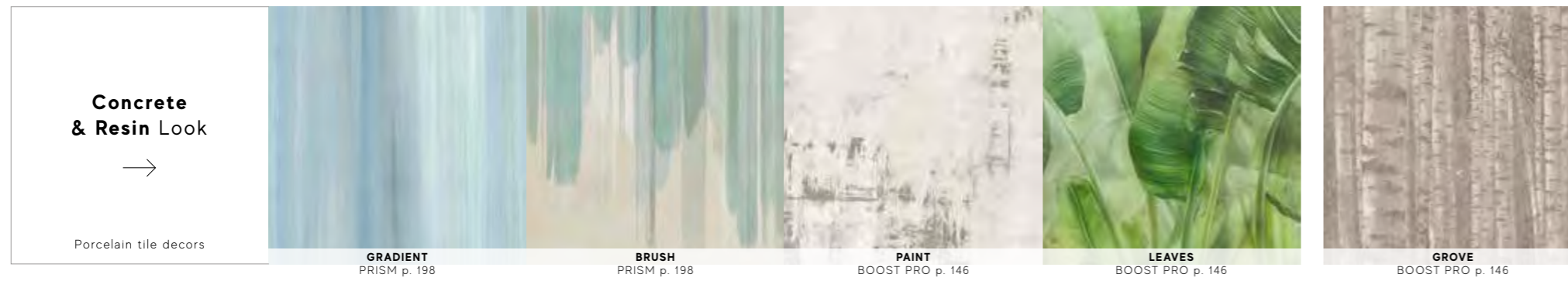

Porcelain tile decors | Metal Look

Decori in gres porcellanato



Porcelain tile decors | Marble Look

Decori in gres porcellanato

Marble Look



Porcelain tile decors

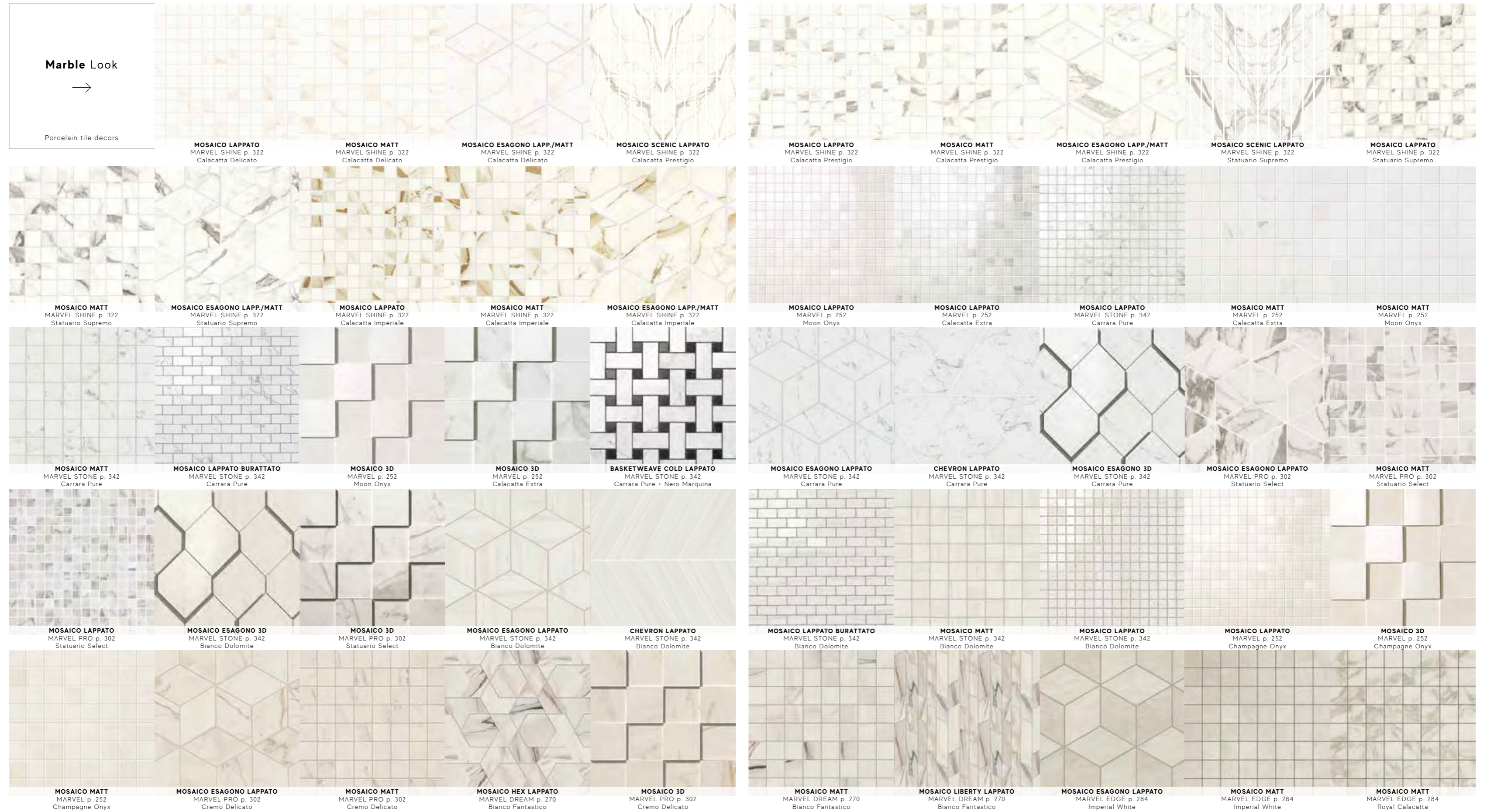

PRODUCT RANGE SUM UP | PORCELAIN TILE DECORS

PRODUCT RANGE SUM UP | PORCELAIN TILE DECORS

Porcelain tile decors | Marble Look

Decori in gres porcellanato



PRODUCT RANGE SUM UP | PORCELAIN TILE DECORS

PRODUCT RANGE SUM UP | PORCELAIN TILE DECORS

Porcelain tile decors | Marble Look

Decori in gres porcellanato



PRODUCT RANGE SUM UP | PORCELAIN TILE DECORS

PRODUCT RANGE SUM UP | PORCELAIN TILE DECORS

Porcelain tile decors | Marble Look

Decori in gres porcellanato

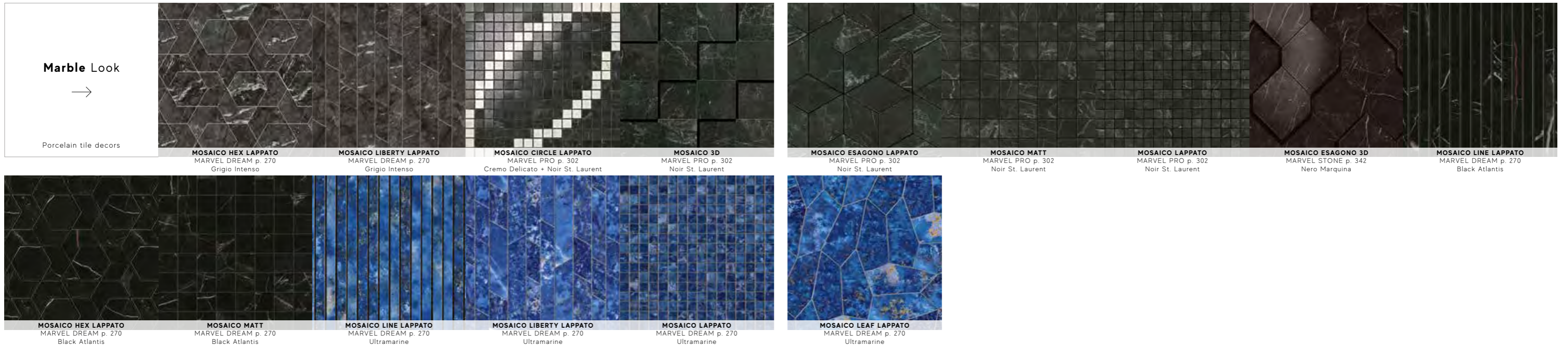

PRODUCT RANGE SUM UP | PORCELAIN TILE DECORS

PRODUCT RANGE SUM UP | PORCELAIN TILE DECORS

Porcelain tile decors | Stone Look

Decori in gres porcellanato

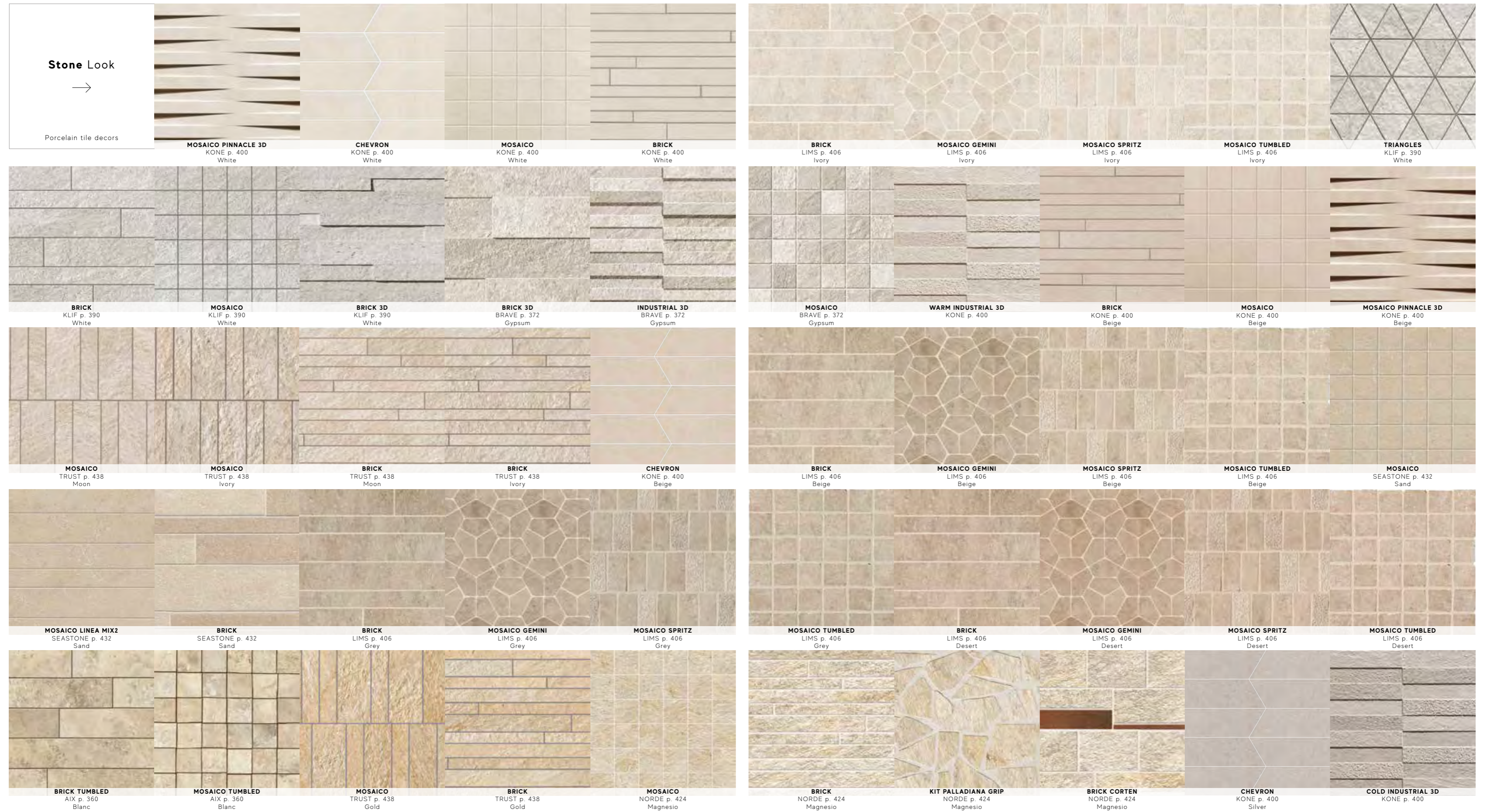

PRODUCT RANGE SUM UP | PORCELAIN TILE DECORS

PRODUCT RANGE SUM UP | PORCELAIN TILE DECORS

Porcelain tile decors | Stone Look

Decori in gres porcellanato

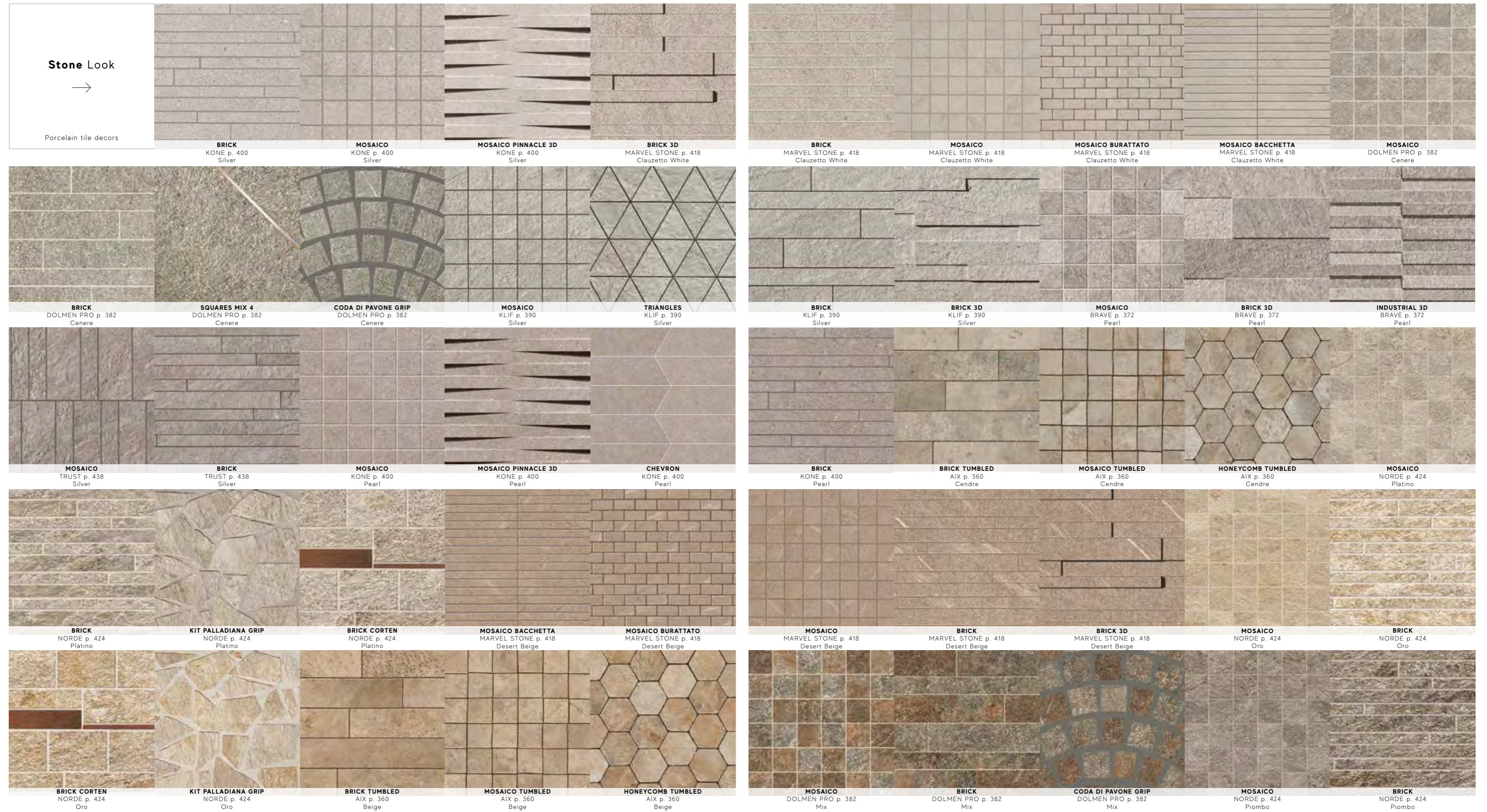

PRODUCT RANGE SUM UP | PORCELAIN TILE DECORS

PRODUCT RANGE SUM UP | PORCELAIN TILE DECORS

Porcelain tile decors | Stone Look

Decori in gres porcellanato

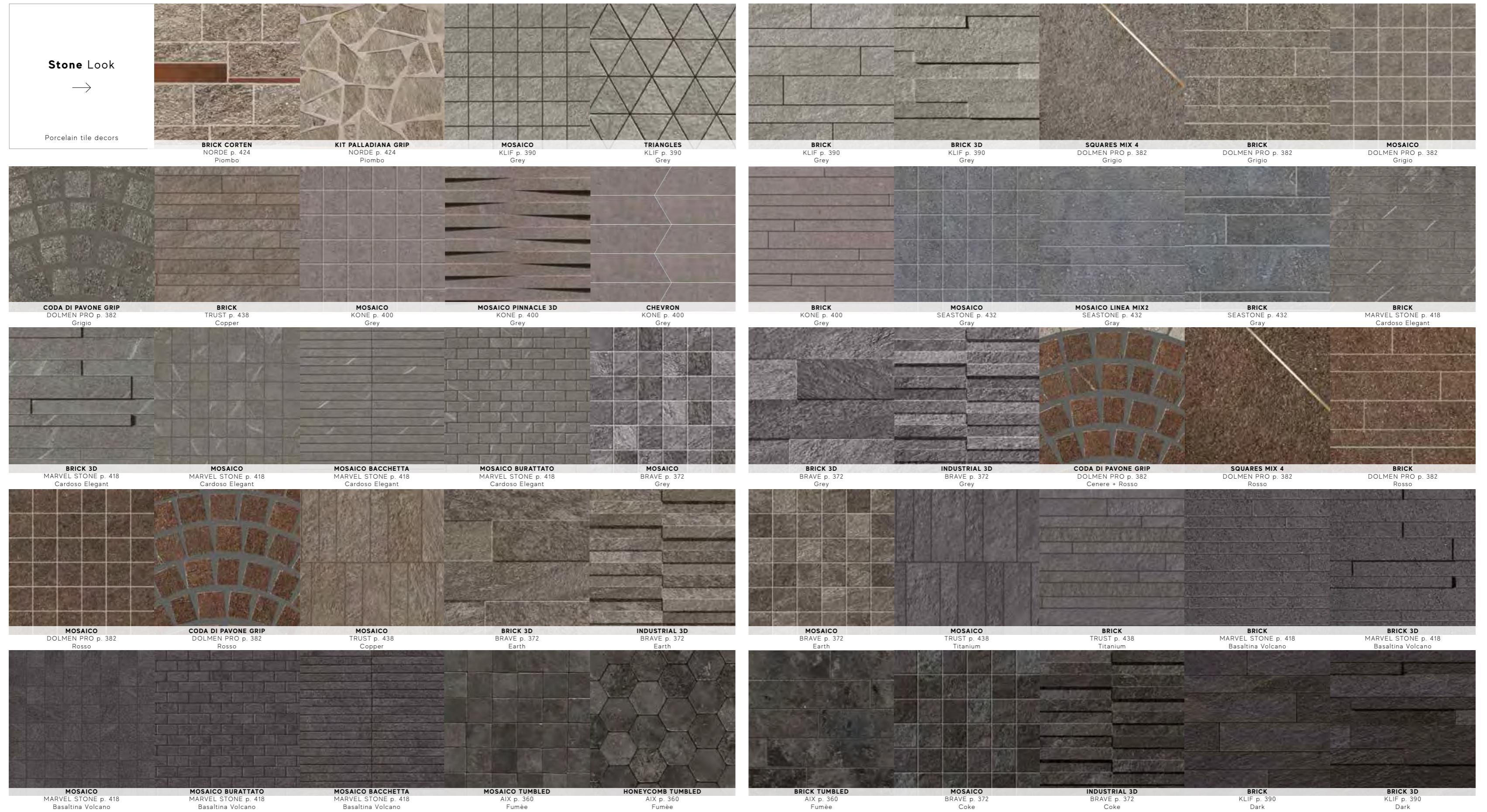

PRODUCT RANGE SUM UP | PORCELAIN TILE DECORS

PRODUCT RANGE SUM UP | PORCELAIN TILE DECORS

Porcelain tile decors | Stone Look

Decori in gres porcellanato



Porcelain tile decors | Wood Look

Decori in gres porcellanato

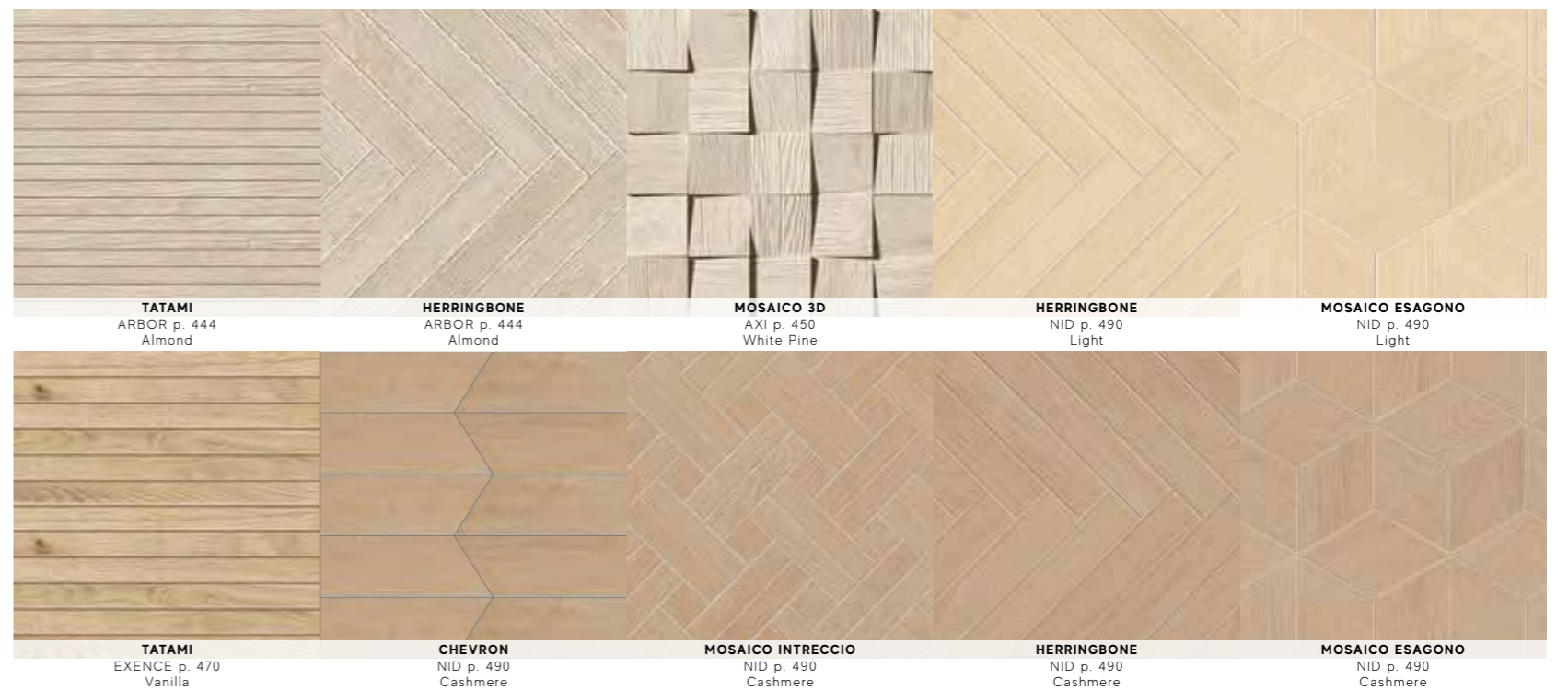

Porcelain tile decors | Wood Look

Decori in gres porcellanato



PRODUCT RANGE SUM UP | PORCELAIN TILE DECORS

PRODUCT RANGE SUM UP | PORCELAIN TILE DECORS

Porcelain tile decors | Wood Look

Decori in gres porcellanato



TATAMI NASH p. 484 Dark Oak
TATAMI ARBOR p. 444 Tobacco
HERRINGBONE ARBOR p. 444 Tobacco
TATAMI NASH p. 484 Light Brown



MOSAICO 3D AXI p. 450 Dark Oak
TATAMI HEARTWOOD p. 478 Moka
MANSION WEAVE HEARTWOOD p. 478 Moka
MARBLE CHEVRON HEARTWOOD p. 478 Moka + Black Atlantis
CHEVRON NASH p. 484 White Wood



CHEVRON NASH p. 484 Greige
TATAMI NASH p. 484 Greige
TATAMI ARBOR p. 444 Grey
HERRINGBONE ARBOR p. 444 Grey
TRECCIA AXI p. 450 Grey Timber



CHEVRON NASH p. 484 Light Brown
TATAMI AXI p. 450 Dark Oak
TRECCIA AXI p. 450 Dark Oak
TATAMI ETIC p. 458 Palissandro
BRICK 3D AXI p. 450 Dark Oak



TATAMI NASH p. 484 White Wood
BRICK 3D AXI p. 450 Silver Fir
MOSAICO 3D AXI p. 450 Silver Fir
TATAMI AXI p. 450 Silver Fir
TRECCIA AXI p. 450 Silver Fir



TATAMI AXI p. 450 Grey Timber
TATAMI NASH p. 484 Gray Wood
CHEVRON NASH p. 484 Gray Wood
MOSAICO 3D AXI p. 450 Grey Timber
BRICK 3D AXI p. 450 Grey Timber

PRODUCT RANGE SUM UP | PORCELAIN TILE DECORS

PRODUCT RANGE SUM UP | PORCELAIN TILE DECORS

Wall tile decors | Concrete & Resin + Metal Look

Decori da rivestimento



Concrete & Resin
+ Metal Look



Wall tile decors



MOSAICO Q
PRISM p. 210
Cotton

MOSAICO BEAD
PRISM p. 210
Cotton

WIGGLE
PRISM p. 210
Cotton

MINIBRICK
ARTY p. 128
Milk

MINIBRICK
BOOST p. 142
White

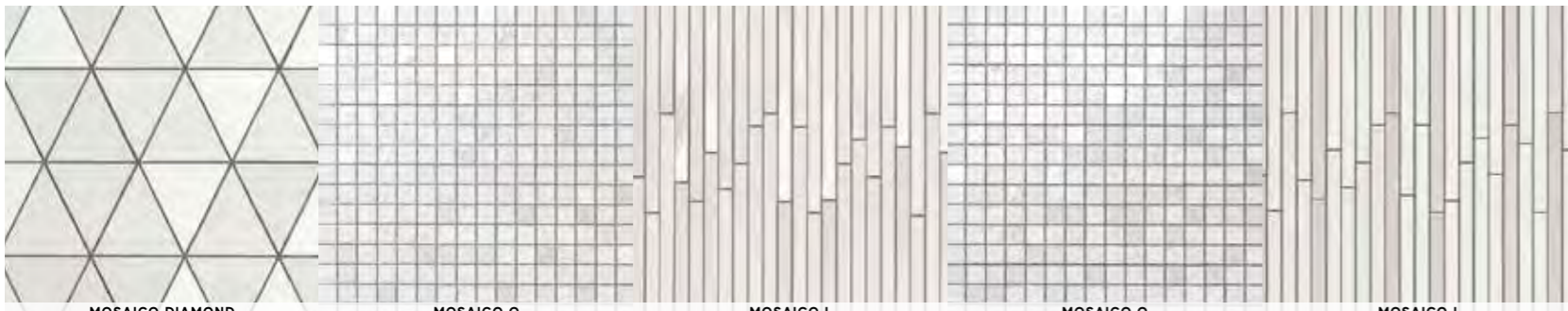

MOSAICO DIAMOND
MEK p. 192
Light

MOSAICO Q
DWELL p. 168
Ice

MOSAICO L
DWELL p. 168
Off White

MOSAICO Q
DWELL p. 168
Off White

MOSAICO L
DWELL p. 168
Ice



URBAN C2
ARTY p. 128
Sugar

MOSAICO FLAG
ARKSHADE p. 120
Light Clay

MINIBRICK
EWALL p. 172
White

GOLD DAMASK
EWALL p. 172
White

MOSAICO FLAG
ARKSHADE p. 120
Cream



MOSAICO Q
ARKSHADE p. 120
Taupe

MOSAICO FLAG
ARKSHADE p. 120
Taupe

GOLD
RAW p. 226
Pearl

MOSAICO BRICK
DWELL p. 168
Silver

MOSAICO L
DWELL p. 168
Silver



MINIBRICK
ARTY p. 128
Sugar

TEXTILE
ARTY p. 128
Milk

MINIBRICK
EWALL p. 172
Pure

TRACE
ARKSHADE p. 120
White

DROPS
ARKSHADE p. 120
White



MOSAICO Q
PRISM p. 210
Cord

MOSAICO BEAD
PRISM p. 210
Cord

MINIBRICK PRO OLIVE
BOOST PRO p. 156
Ivory

MOSAICO Q
MEK p. 192
Light

MOSAICO CHEVRON
MEK p. 192
Light

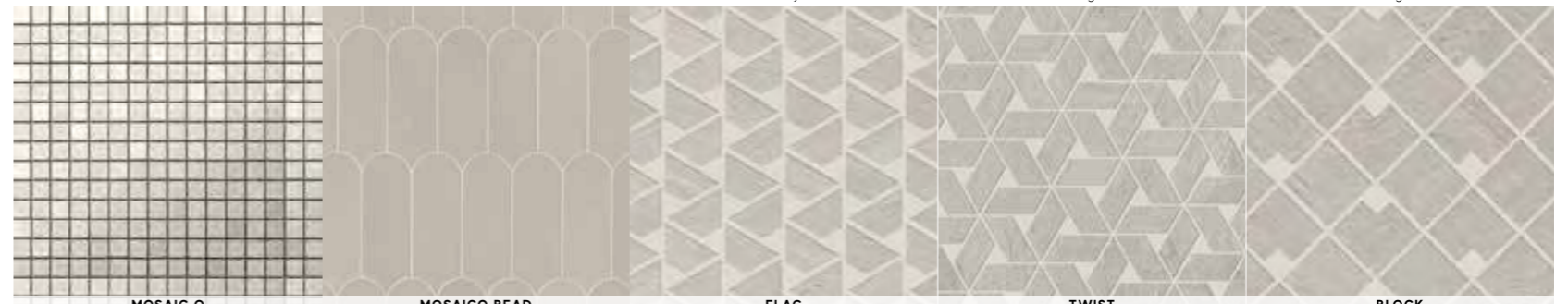

MOSAICO Q
PRISM p. 210
Cloud

MOSAICO BEAD
PRISM p. 210
Cloud

FLAG
RAW p. 226
Pearl

TWIST
RAW p. 226
Pearl

BLOCK
RAW p. 226
Pearl



MOSAICO Q
ARKSHADE p. 120
Cream

FLAG
RAW p. 226
Sand

TWIST
RAW p. 226
Sand

BLOCK
RAW p. 226
Sand

MOSAICO Q
ARKSHADE p. 120
Light Clay



MOSAICO Q
DWELL p. 168
Silver

GOLD
RAW p. 226
Sand

MINIBRICK
EWALL p. 172
Suede

MINIBRICK PRO BLUE
BOOST PRO p. 156
Cream

MINIBRICK
ARTY p. 128
Malt

PRODUCT RANGE SUM UP | WALL TILE DECORS

PRODUCT RANGE SUM UP | WALL TILE DECORS

Wall tile decors | Concrete & Resin + Metal Look

Decori da rivestimento



Concrete & Resin + Metal Look
Wall tile decors



DROPS ARKSHADE p. 120 Taupe
MINIBRICK PRO COFFEE BOOST PRO p. 156 Clay
MOSAICO NEST BLAZE p. 246 Aluminium
TEXTURE BLAZE p. 246 Aluminium

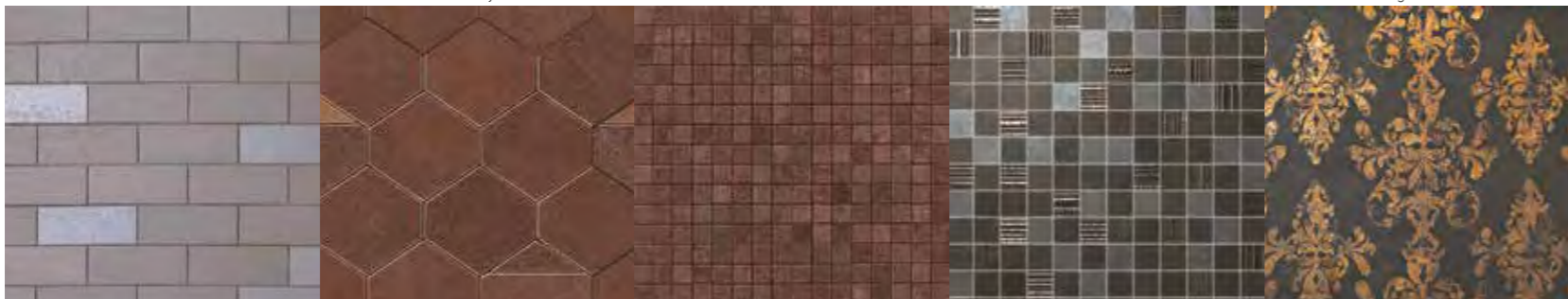

MINIBRICK BOOST p. 142 Pearl
MINIBRICK BOOST p. 142 Grey
MINIBRICK EWALL p. 172 Concrete
ENIGMA PRISM p. 210
MOSAICO FLAG ARKSHADE p. 120 Light Dove



MINIBRICK ARTY p. 128 Charcoal
MOSAICO NEST BLAZE p. 246 Corten
MOSAICO Q BLAZE p. 246 Corten
MOSAIC EWALL p. 172 Platinum
GOLD DAMASK EWALL p. 172 Moka

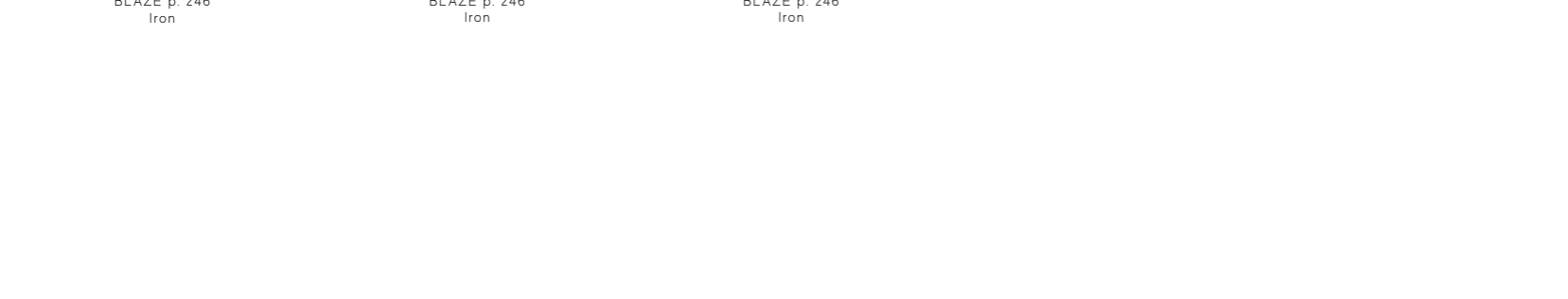

MOSAICO NEST BLAZE p. 246 Iron
MOSAICO Q BLAZE p. 246 Iron
STRIPES BLAZE p. 246 Iron



MOSAICO Q BLAZE p. 246 Aluminium
MOSAICO DIAMOND MEK p. 192 Medium
MOSAICO CHEVRON MEK p. 192 Medium
MOSAICO Q ARKSHADE p. 120 Light Dove
MOSAICO Q MEK p. 192 Medium



MOSAICO Q PRISM p. 210 Suede
MOSAICO BEAD PRISM p. 210 Suede
MINIBRICK BOOST p. 142 Smoke
MOSAICO FLAG ARKSHADE p. 120 Deep Grey
MOSAICO Q ARKSHADE p. 120 Deep Grey



STRIPES EWALL p. 172 Moka
MINIBRICK EWALL p. 172 Moka
MOSAICO Q PRISM p. 210 Graphite
MOSAICO BEAD PRISM p. 210 Graphite
MINIBRICK EWALL p. 172 Night

PRODUCT RANGE SUM UP | WALL TILE DECORS

PRODUCT RANGE SUM UP | WALL TILE DECORS

Wall tile decors | Marble Look

Decori da rivestimento



PRODUCT RANGE SUM UP | WALL TILE DECORS

PRODUCT RANGE SUM UP | WALL TILE DECORS

Wall tile decors | Marble Look

Decori da rivestimento

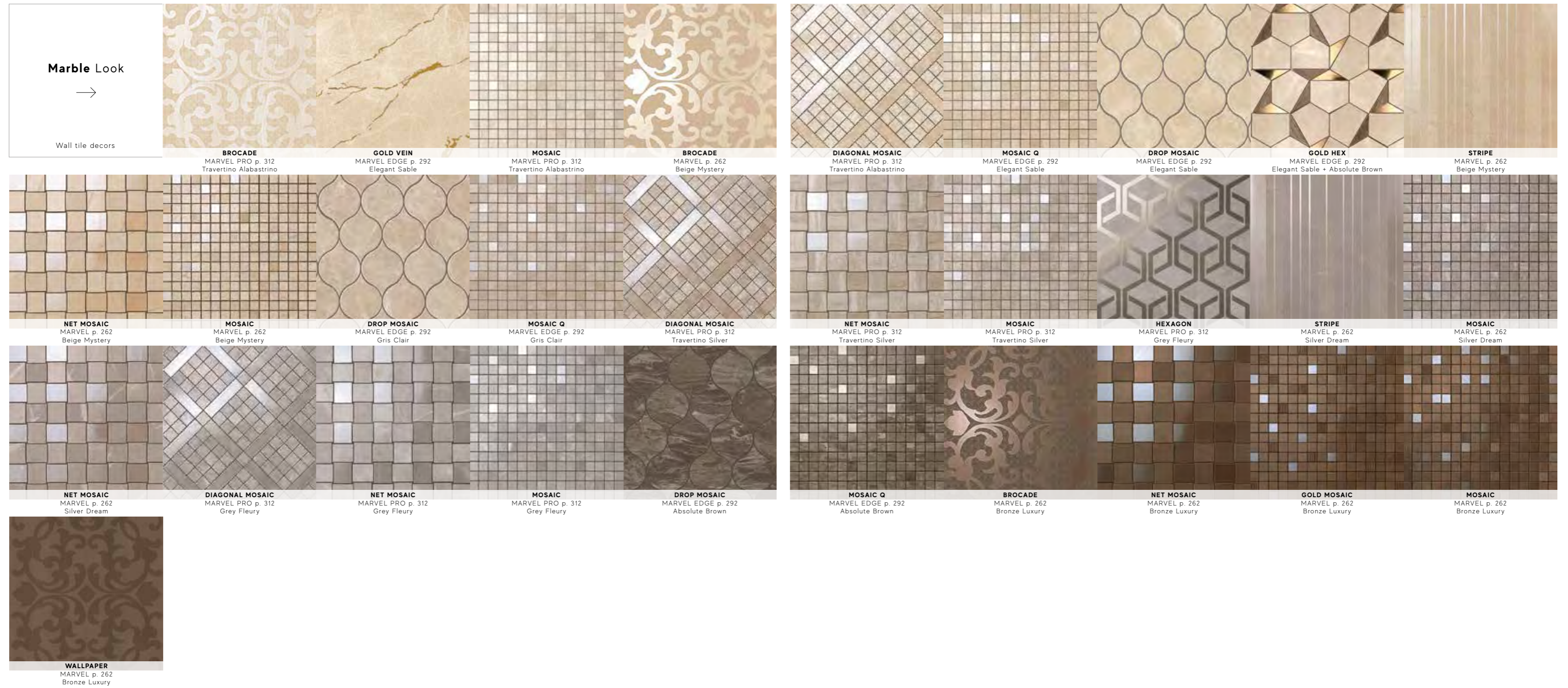

PRODUCT RANGE SUM UP | WALL TILE DECORS

PRODUCT RANGE SUM UP | WALL TILE DECORS

Wall tile decors | Marble Look

Decori da rivestimento

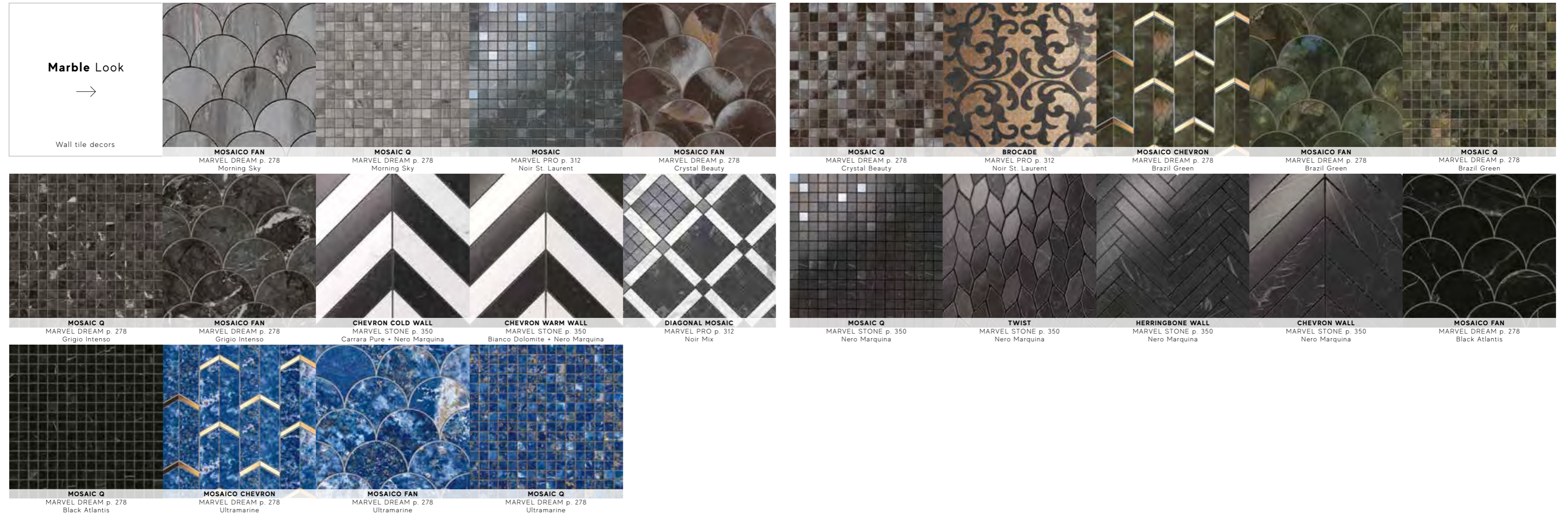

PRODUCT RANGE SUM UP | WALL TILE DECORS

PRODUCT RANGE SUM UP | WALL TILE DECORS

Wall tile decors | Color Look

Decori da rivestimento



PRODUCT RANGE SUM UP | WALL TILE DECORS

PRODUCT RANGE SUM UP | WALL TILE DECORS

Wall tile decors | Color Look & Stone Look

Decori da rivestimento



MOSAICO Q ARKSHADE p. 120 Blue
MOSAICO NEST BLAZE p. 246 Verdigris
MOSAICO Q PRISM p. 210 Dusk
MOSAICO BEAD PRISM p. 210 Dusk



STRIPES EWALL p. 172 Petroleum Green
FLAG RAW p. 226 Petroleum
TWIST RAW p. 226 Petroleum
BLOCK RAW p. 226 Petroleum
MOSAICO Q ARKSHADE p. 120 Gemstone



MOSAICO Q PRISM p. 210 Moss
MOSAICO BEAD PRISM p. 210 Moss
WIGGLE PRISM p. 210 Moss
MIX 4 DWELL p. 168 Turquoise
MOSAICO MIX DWELL p. 168 Turquoise

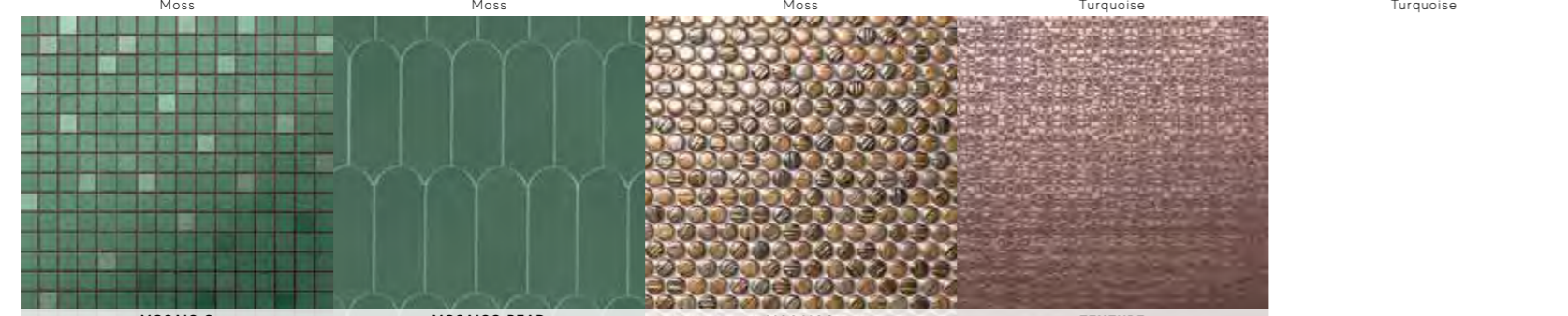

MOSAICO Q PRISM p. 210 Emerald
MOSAICO BEAD PRISM p. 210 Emerald
MOSAICO GOLD CIRCLES MEK p. 192
TEXTURE BLAZE p. 246 Corten



MOSAIC BRAVE p. 378 Gypsum
MINIBRICK TUMBLED AIX p. 368 Blanc
MOSAIC BRAVE p. 378 Pearl
MINIBRICK TUMBLED AIX p. 368 Cendre

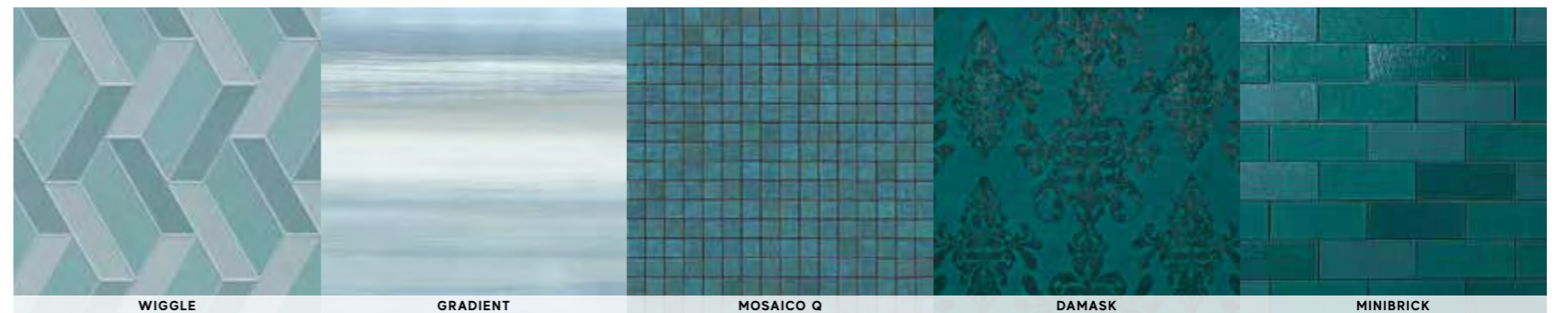

WIGGLE PRISM p. 210 Dusk
GRADIENT PRISM p. 210
MOSAICO Q BLAZE p. 246 Verdigris
DAMASK EWALL p. 172 Petroleum Green
MINIBRICK EWALL p. 172 Petroleum Green

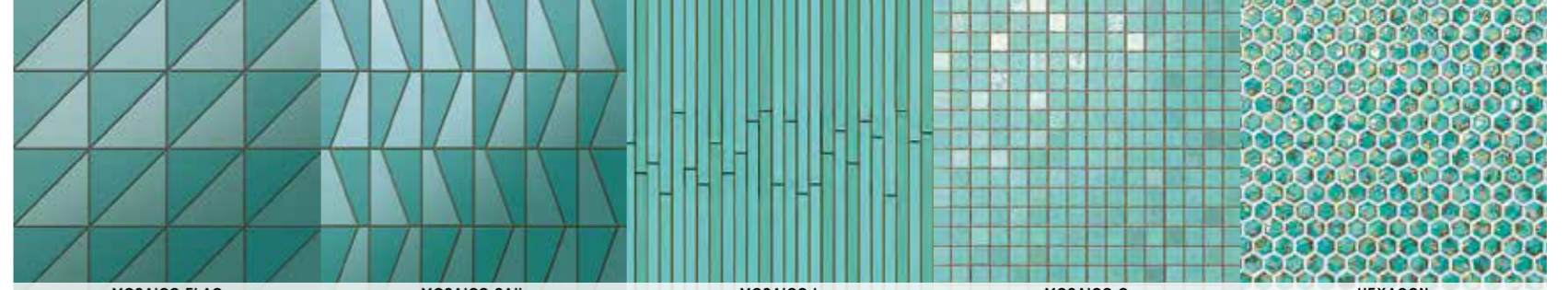

MOSAICO FLAG ARKSHADE p. 120 Gemstone
MOSAICO SAIL ARKSHADE p. 120 Gemstone
MOSAICO L DWELL p. 168 Turquoise
MOSAICO Q DWELL p. 168 Turquoise
HEXAGON DWELL p. 168 Turquoise

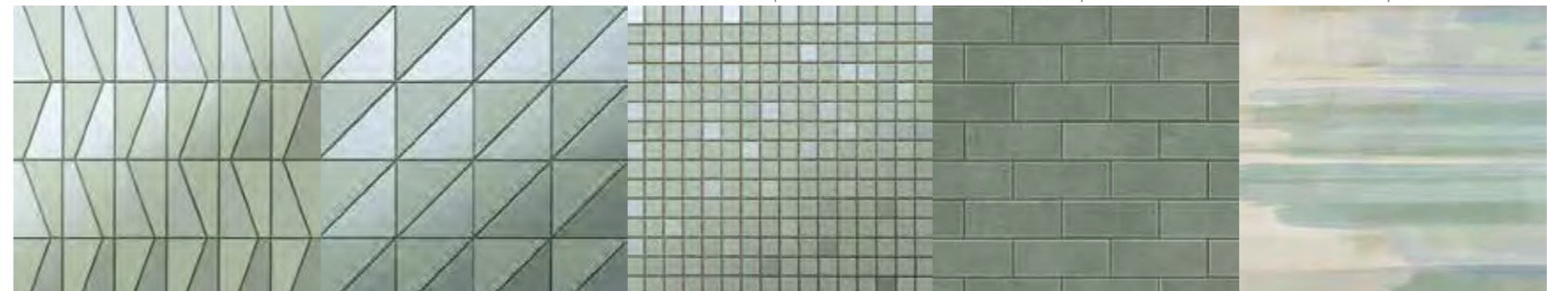

MOSAICO SAIL ARKSHADE p. 120 Sage
MOSAICO FLAG ARKSHADE p. 120 Sage
MOSAICO Q ARKSHADE p. 120 Sage
MINIBRICK BOOST p. 142 Sage
BRUSH PRISM p. 210



MINIBRICK TUMBLED AIX p. 368 Beige
MOSAIC BRAVE p. 378 Grey

PRODUCT RANGE SUM UP | WALL TILE DECORS

PRODUCT RANGE SUM UP | WALL TILE DECORS



3D Wall Tiles / Rivestimento 3D

WHITEBODY WALL TILES - RECTIFIED MONOCALIBER
RIVESTIMENTI IN PASTA BIANCA - RETTIFICATO MONOCALIBRO

Sinuous Design

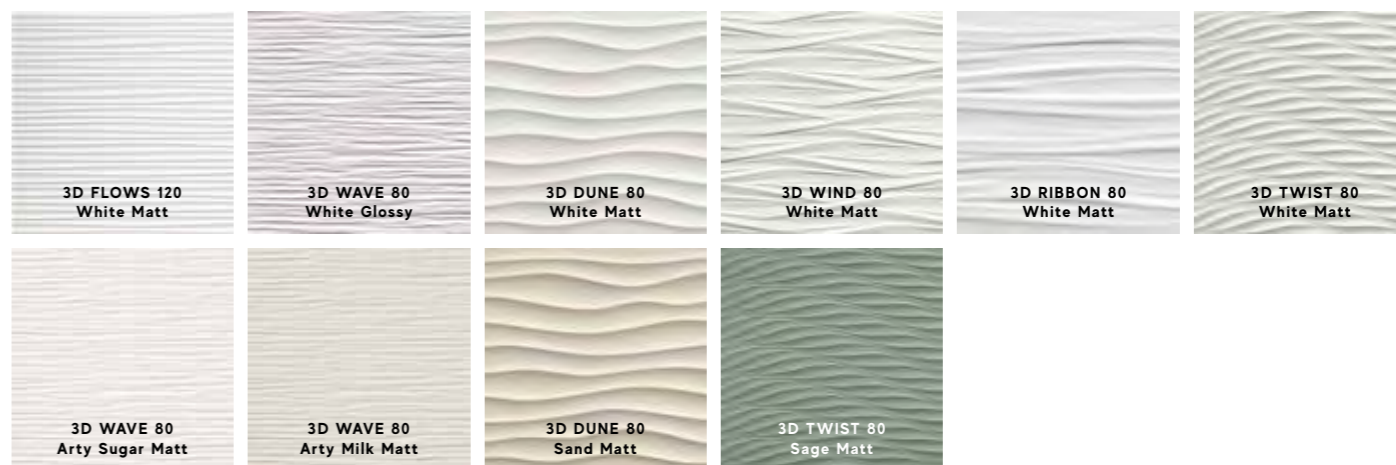

Multi-Faceted Design



Geometric Design



Sizes	Thickness	Surface finish
50x120 cm - 19 ⁵ / ₈ "x47 ¹ / ₄ "	± 11 mm	Matte, Shiny
40x80 cm - 15 ³ / ₄ "x31 ¹ / ₂ "	± 10 mm	Matte, Shiny
30,5x56 cm - 12"x22"	± 9,5 mm	Matte

Solid Design ± 8,5 mm



Sizes	Thickness	Surface finish
50x120 cm - 19 ⁵ / ₈ "x47 ¹ / ₄ "	± 8,5 mm	Matte, Shiny
40x80 cm - 15 ³ / ₄ "x31 ¹ / ₂ "	± 8,5 mm	Matte, Shiny
30,5x56 cm - 12"x22"	± 8,5 mm	Matte

3D WALL Tiles / Rivestimento 3D

MATTE SURFACE / SUPERFICIE MATT



A6BJ 3D Ultra Blade White Matt 120 *
50x120 cm - 19⁵/₈"x47¹/₄"



A6BH 3D Line White Matt 120 *
50x120 cm - 19⁵/₈"x47¹/₄"



A6BI 3D Flows White Matt 120 *
50x120 cm - 19⁵/₈"x47¹/₄"

* Registered Community Design



8DMA 3D Angle White Matt 80 *
40x80 cm - 15³/₄"x31¹/₂"



8DBW 3D Blade White Matt 80 *
40x80 cm - 15³/₄"x31¹/₂"



8DWF 3D Flake White Matt 80 *
40x80 cm - 15³/₄"x31¹/₂"

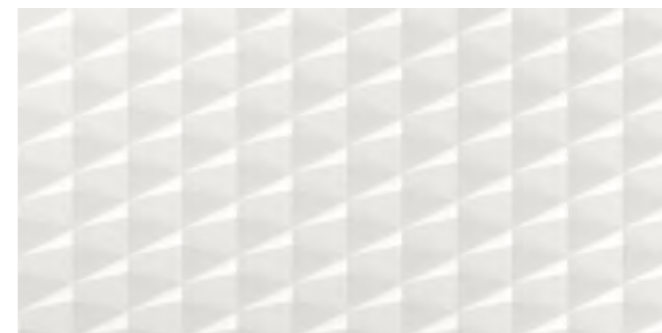

8DAW 3D Stars White Matt 80 *
40x80 cm - 15³/₄"x31¹/₂"



8DMH 3D Mesh White Matt 80 *
40x80 cm - 15³/₄"x31¹/₂"



8DDI 3D Diamond White Matt 80 *
40x80 cm - 15³/₄"x31¹/₂"



8DFW 3D Flash White Matt 80 *
40x80 cm - 15³/₄"x31¹/₂"



8DDN 3D Diamond Night Matt 80 *
40x80 cm - 15³/₄"x31¹/₂"

* Registered Community Design



V1
UNIFORM
VARIATION

MATTE SURFACE | SUPERFICIE MATT | Surface Mat | Matt oberfläche | Superficie Mate | Матовая поверхность



V1
UNIFORM
VARIATION

103

3D WALL Tiles / Rivestimento 3D

MATTE SURFACE / SUPERFICIE MATT



8DUW 3D Dune White Matt 80 *
40x80 cm - 15³/₄"x31¹/₂"



8DUS 3D Dune Sand Matt 80 *
40x80 cm - 15³/₄"x31¹/₂"



8DWM 3D Twist White Matt 80 *
40x80 cm - 15³/₄"x31¹/₂"

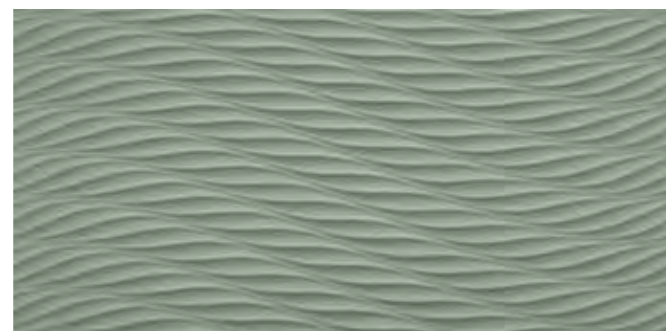

8DSM 3D Twist Sage Matt 80 *
40x80 cm - 15³/₄"x31¹/₂"



8DMW 3D Wind White Matt 80 *
40x80 cm - 15³/₄"x31¹/₂"

* Registered Community Design

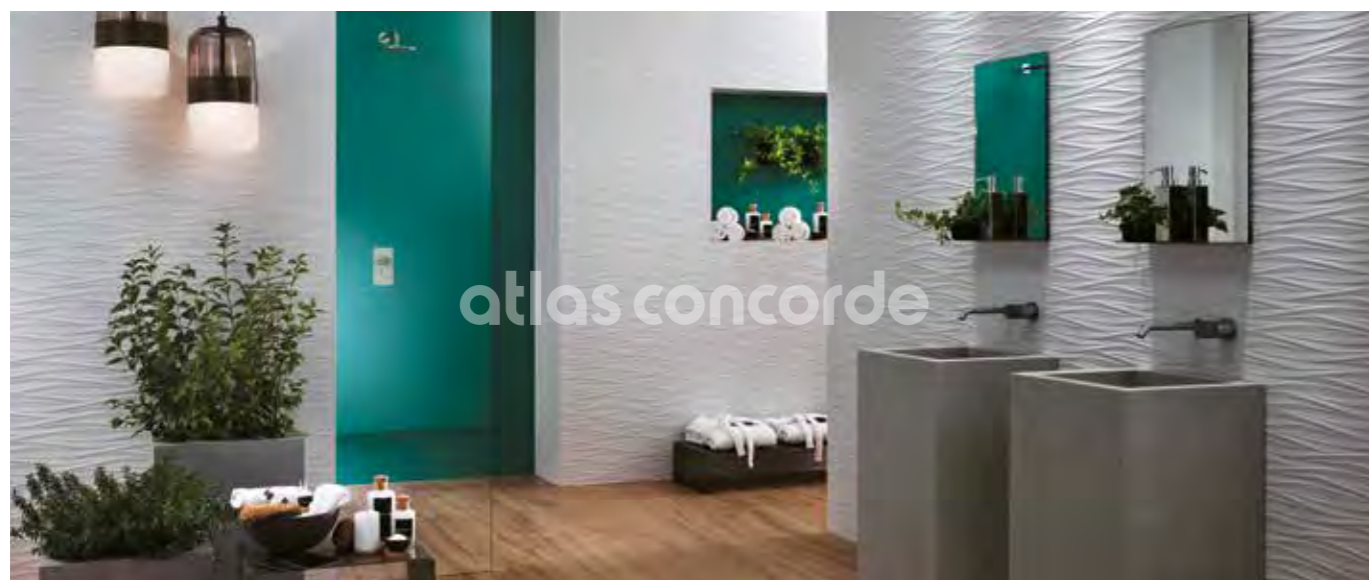

MATTE SURFACE | SUPERFICIE MATT | Surface Mat | Matt oberfläche | Superficie Mate | Матовая поверхность



8AWS Arty Sugar Wave Matt 80 *
40x80 cm - 15³/₄"x31¹/₂"



8AWM Arty Milk Wave Matt 80 *
40x80 cm - 15³/₄"x31¹/₂"



8SBW 3D Ribbon White Matt 80 *
40x80 cm - 15³/₄"x31¹/₂"

SHINY SURFACE / SUPERFICIE LUCIDA



8DWG 3D Wave White Glossy 80 *
40x80 cm - 15³/₄"x31¹/₂"

* Registered Community Design

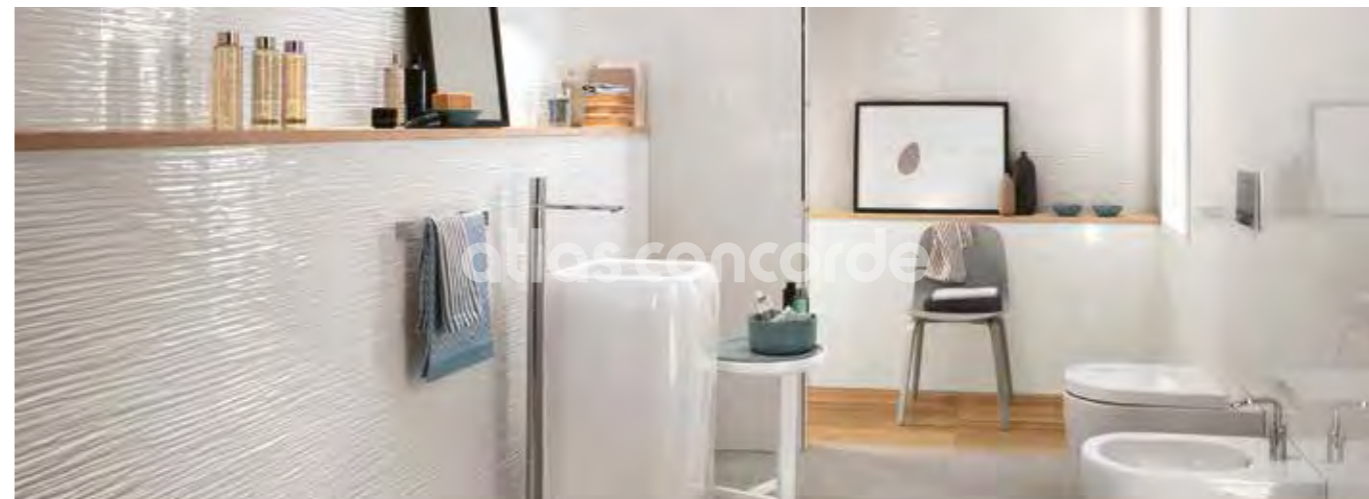

MATTE SURFACE | SUPERFICIE MATT | Surface Mat | Matt oberfläche | Superficie Mate | Матовая поверхность
SHINY SURFACE | SUPERFICIE LUCIDA | Surface brillante | Glänzende oberfläche | Superficie brillante | Глянцевая поверхность



V1
UNIFORM
VARIATION



V1
UNIFORM
VARIATION

3D WALL Tiles / Rivestimento 3D

MATTE SURFACE / SUPERFICIE MATT

9D5B 3D Ultra Blade White Matt 56 *
30,5x56 cm - 12"x22"9D5L 3D Line White Matt 56 *
30,5x56 cm - 12"x22"9D5W 3D Wave White Matt 56 *
30,5x56 cm - 12"x22"

DECOR RANGE / GAMMA DECORI

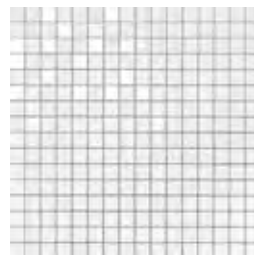
9DSM Solid White Mosaic
30,5x30,5 - 12"x12"

TRIM TILES / PEZZI SPECIALI

LDWM Spigolo 10mm White Matt *
1x20 cm - 3/8"x7 7/8"LDWG Spigolo 10mm White Glossy *
1x20 cm - 3/8"x7 7/8"LDAM Spigolo 10mm Sand Matt *
1x20 cm - 3/8"x7 7/8"LDNM Spigolo 10mm Night Matt *
1x20 cm - 3/8"x7 7/8"

* THESE PARTS ARE SUPPLIED TO ORDER . I PEZZI SONO DISPONIBILI SU ORDINAZIONE
Les pièces sont disponibles sur commande | Die Teile sind auf Bestellung lieferbar | Las piezas se hacen por encargo | Изготавливаются на заказ

* Registered Community Design



The 10 mm edge matches three-dimensional wall tiles having a 10-11 mm thickness / Lo spigolo 10 mm si abbina a rivestimenti tridimensionali di spessore 10-11 mm/ Le bord 10 mm s'adapte aux revêtements tridimensionnels épaisseur 10-11 mm / Die 10 mm Kante ist mit dreidimensionalen Wandfliesen mit einer Dicke von 10-11 mm kombinierbar / La arista de 10 mm se combina con revestimientos tridimensionales de 10 -11 mm de grosor / Угловой элемент 10 мм сочетается с трехмерной настенной плиткой толщиной 10-11 мм

MATTE SURFACE | SUPERFICIE MATT | Surface Mat | Matt oberfläche | Superficie Mate | Матовая поверхность



3D WALL Tiles / Rivestimento 3D

MATTE&SHINY SURFACE / SUPERFICIE MATT E LUCIDA ± 8,5 mm

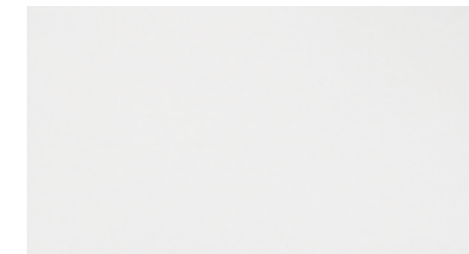
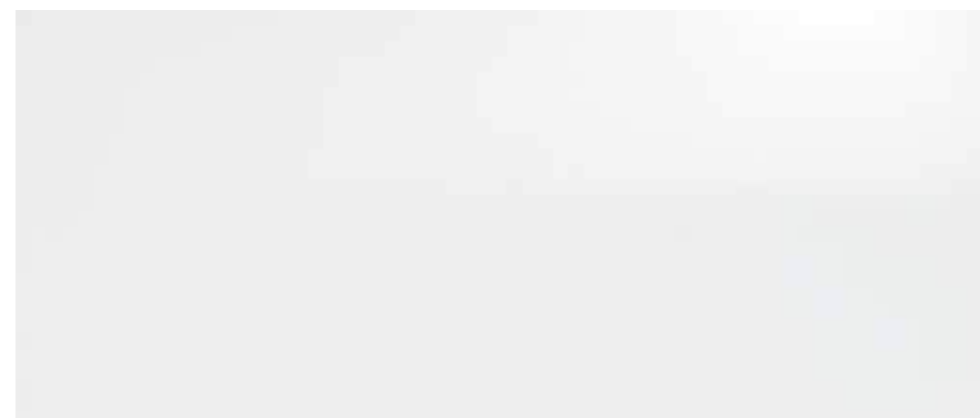
A6BF Solid White Matt 120
50x120 cm - 19 3/8"x47 1/4"9D5S Solid White Matt 56
30,5x56 cm - 12"x22"A6BG Solid White Glossy 120
50x120 cm - 19 3/8"x47 1/4"

TRIM TILES / PEZZI SPECIALI

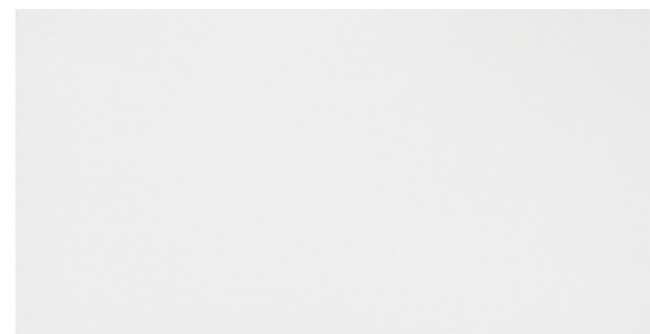
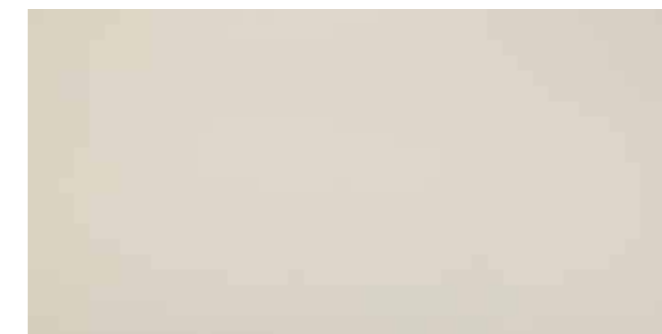
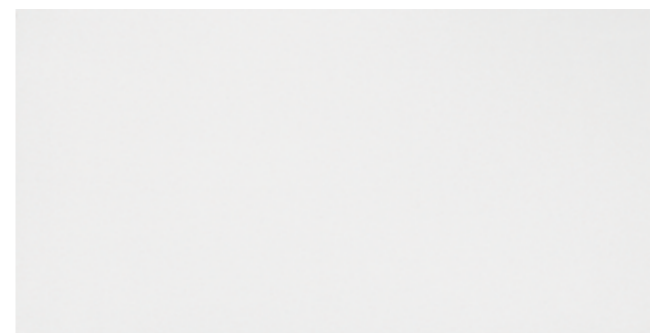
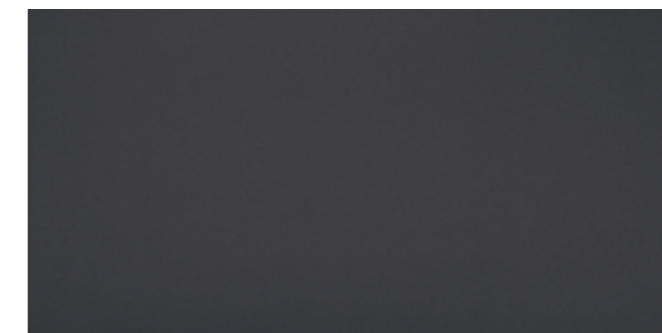
LD8W Spigolo 8,5mm White Matt
0,8x20 cm - 3/8"x7 7/8"A8DW Spigolo 8,5mm White Matt A.E.
0,8x0,8 cm - 3/8"x3/8"8DSO Solid White Matt 80
40x80 cm - 15 3/4"x31 1/2"8DSA Solid Sand Matt 80
40x80 cm - 15 3/4"x31 1/2"8DSL Solid White Glossy 80
40x80 cm - 15 3/4"x31 1/2"8DSI Solid Night Matt 80
40x80 cm - 15 3/4"x31 1/2"

V1
UNIFORM
VARIATION

MATTE SURFACE | SUPERFICIE MATT | Surface Mat | Matt oberfläche | Superficie Mate | Матовая поверхность
SHINY SURFACE | SUPERFICIE LUCIDA | Surface brillante | Glänzende oberfläche | Superficie brillante | Плещ поверхность



V1
UNIFORM
VARIATION

FACTORY ATLAS
CONCORDE
CREATIVE
BUREAU

Piero Lissoni
Canone Inverso

PORCELAIN TILES

The Atlas Concorde decor collection

by Piero Lissoni

Each decoration goes perfectly with the collection it is made from.

Canone Inverso reflects a combination of fluidity and materiality. It interprets the vision that Atlas Concorde had given Piero Lissoni: create decorative elements for wall and floor tiles. The collection offers designers the possibility of combining each module/mosaic with Atlas Concorde floor and wall tiles.

Canone Inverso riflette una combinazione di fluidità e matericità e si fa interprete del pensiero progettuale che Atlas Concorde ha condiviso con Piero Lissoni: ideare elementi decorativi, mosaici, tagli, per rivestimenti murali e da pavimento. La collezione offre ai progettisti la possibilità di abbinare ciascun modulo/mosaico ai rivestimenti per pavimento e per pareti di Atlas Concorde.

"The four compositions of the Canone Inverso collection are the variants of a model, a scheme that is composed and recomposed to create a harmonious relationship that like in a musical score is formed by the assembly of different notes, or rather the forms that make it up".

"Le quattro composizioni della collezione Canone Inverso sono le varianti di un modello, uno schema che viene composto e ricomposto per dare vita a un rapporto armonico che, come in una partitura musicale, è formato dall'assemblaggio delle diverse note, ovvero dalle forme che lo costituiscono."

Canone Inverso 1

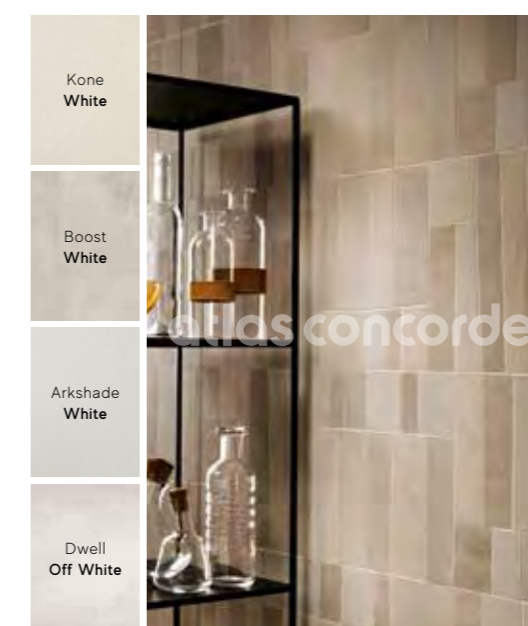

Canone Inverso 2



Canone Inverso 3

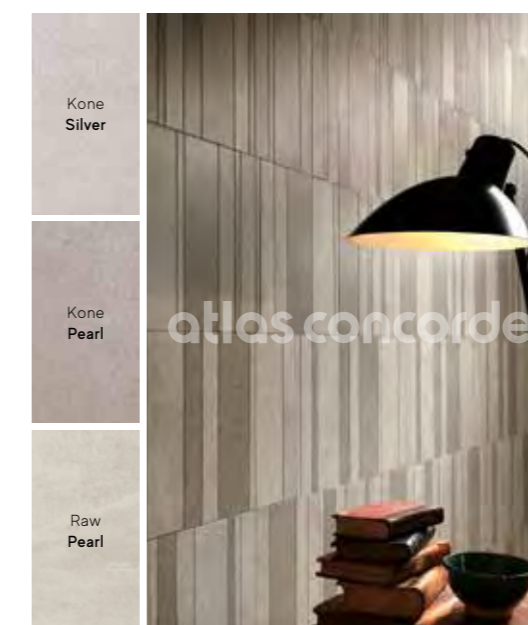

Canone Inverso 4



CANONE INVERSO

Porcelain Tiles / Gres Porcellanato

Canone Inverso 1

81x32 cm 31⁷/₈"x12⁵/₈"
A19U Canone Inverso 1

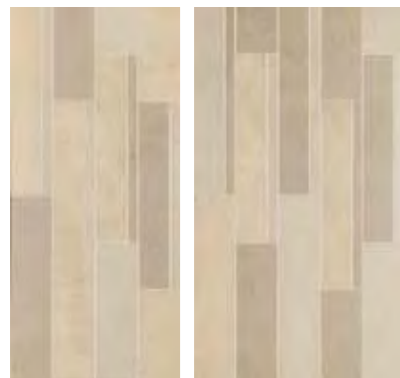
**Canone Inverso 2**

59x59 cm 23"x23"
A19V Canone Inverso 2

**Canone Inverso 3**

47x147 cm 18¹/₂"x57¹/₈"
A2US Canone Inverso 3

Canone Inverso 4

59x78 cm 23¹/₄"x30³/₄"
A19X Canone Inverso 4





ARKSHADE

PORCELAIN&WALL TILES

Porcelain Tiles / Gres Porcellanato

COLOURED BODY PORCELAIN TILES - RECTIFIED MONOCALIBER
GRES PORCELLANATO COLORATO IN MASSA - RETTIFICATO MONOCALIBRO



Sizes	Thickness	Surface finish
75x150 cm - 29 ¹ / ₂ "x59"	± 9 mm	Matte R10 A
60x60 cm - 23 ⁵ / ₈ "x23 ⁵ / ₈ "	± 9 mm	Polished Matte R10 A
30x60 cm - 11 ³ / ₄ "x23 ⁵ / ₈ "	± 9 mm	Polished Matte R10 A

Outdoor Paving and Wet Areas

OUTDOOR PAVING p. 554

Sizes	Thickness	Surface finish
30x60 cm - 11 ³ / ₄ "x23 ⁵ / ₈ "	± 9 mm	Grip R11 A+B

Wall Tiles / Rivestimento

WHITEBODY WALL TILES - RECTIFIED MONOCALIBER
RIVESTIMENTI IN PASTA BIANCA - RETTIFICATO MONOCALIBRO



Sizes	Thickness	Surface finish
40x80 cm - 15 ³ / ₄ "x31 ¹ / ₂ "	± 8,5 mm	Matte

3D Wall Tiles

Sizes	Thickness	Surface finish
40x80 cm - 15 ³ / ₄ "x31 ¹ / ₂ "	± 10 mm	Matte

ARKSHADE Porcelain Tiles / Gres Porcellanato

MATTE SURFACE / SUPERFICIE MATT



75x150 cm 29 1/2" x 59"
 AUF0 Arkshade White 75x150
 AUFP Arkshade Clay 75x150
 AUFQ Arkshade Dove 75x150
 AUFR Arkshade Grey 75x150
 AUFS Arkshade Lead 75x150

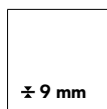

60x60 cm 23 5/8" x 23 5/8"
 AUF8 Arkshade White 60x60
 AUF9 Arkshade Clay 60x60
 AUGA Arkshade Dove 60x60
 AUGB Arkshade Grey 60x60
 AUGC Arkshade Lead 60x60

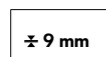

30x60 cm 11 3/4" x 23 5/8"
 D205 Arkshade White 30x60
 D206 Arkshade Clay 30x60
 D207 Arkshade Dove 30x60
 D208 Arkshade Grey 30x60
 D209 Arkshade Lead 30x60

GRIP SURFACE / SUPERFICIE GRIP

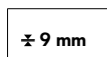

30x60 cm 11 3/4" x 23 5/8"
 D210 Arkshade White 30x60 Grip
 D211 Arkshade Clay 30x60 Grip
 D213 Arkshade Dove 30x60 Grip
 D214 Arkshade Grey 30x60 Grip
 D215 Arkshade Lead 30x60 Grip

POLISHED SURFACE / SUPERFICIE LAPPATA

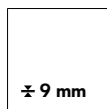

60x60 cm 23 5/8" x 23 5/8"
 AUGD Arkshade White 60x60 Lappato
 AUGE Arkshade Clay 60x60 Lappato
 AUGF Arkshade Dove 60x60 Lappato
 AUGG Arkshade Grey 60x60 Lappato
 AUGH Arkshade Lead 60x60 Lappato

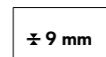

30x60 cm 11 3/4" x 23 5/8"
 D195 Arkshade White 30x60 Lappato
 D196 Arkshade Clay 30x60 Lappato
 D197 Arkshade Dove 30x60 Lappato
 D198 Arkshade Grey 30x60 Lappato
 D199 Arkshade Lead 30x60 Lappato

The glossy polished finish is suitable for residential or low-traffic commercial floors, where no anti-slip performance is required, and for walls. The glossy polished surface finish, surprisingly brilliant and bright, features slight irregularities. The extraordinary brilliance and the easy cleaning of the surface are the result of in-depth research aimed at guaranteeing its durability over time. If the product is in direct contact with the outdoors, provide devices for absorbing moisture and dirt to prevent scratches. / La finitura lappata lucida è indicata per pavimenti residenziali o commerciali poco sollecitati, laddove non siano richieste prestazioni antiscivolo, e per rivestimenti. La finitura lappata lucida offre una superficie sorprendentemente brillante e specchiante, con lievi irregolarità. La straordinaria lucentezza e l'elevata pulibilità della superficie sono frutto di studi approfonditi e accurate ricerche tecniche volte a garantirne la persistenza nel tempo. Se il prodotto è a diretto contatto con l'esterno, prevedere dei dispositivi di assorbimento dell'umidità e della sporcizia per prevenire la formazione di graffi.

MATTE SURFACE | SUPERFICIE MATT | Surface Mat | Matt oberfläche | Superficie Mate | Матовая поверхность
GRIP SURFACE | SUPERFICIE GRIP | Surface grip | Grip oberfläche | Superficie Grip | Grip поверхность
POLISHED SURFACE | SUPERFICIE LAPPATA | Surface aducil | Gelappt oberfläche | Superficie brufido | Полуполированный поверхность

V1
UNIFORM
APPEARANCE

MATTE / GRIP



WHITE



CLAY



DOVE



GREY



LEAD

POLISHED



WHITE



CLAY



DOVE



GREY



LEAD

ARKSHADE Porcelain Tiles / Gres Porcellanato

DECOR RANGE / GAMMA DECORI



AUID Arkshade White Mosaico Prisma 36x36 - 14¹/₈"x14¹/₈"
 AUIE Arkshade Clay Mosaico Prisma 36x36 - 14¹/₈"x14¹/₈"
 AUIF Arkshade Dove Mosaico Prisma 36x36 - 14¹/₈"x14¹/₈"
 AUIG Arkshade Grey Mosaico Prisma 36x36 - 14¹/₈"x14¹/₈"
 AUIH Arkshade Lead Mosaico Prisma 36x36 - 14¹/₈"x14¹/₈"

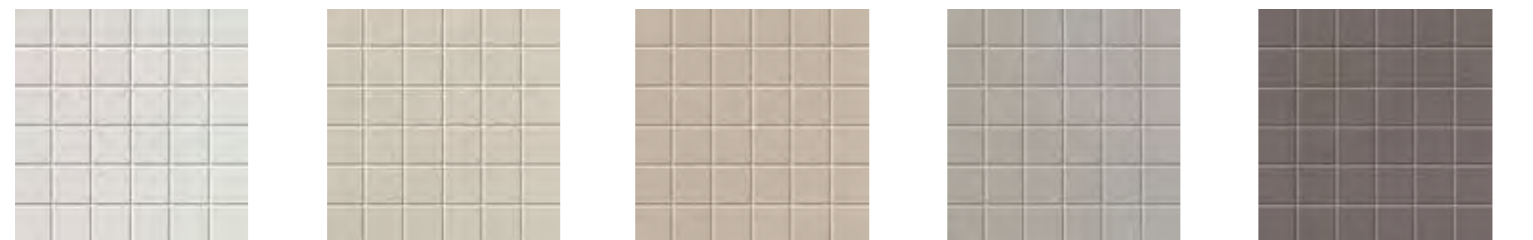

AUHA Arkshade White Mosaico 30x30 - 11³/₄"x11³/₄"
 AUHB Arkshade Clay Mosaico 30x30 - 11³/₄"x11³/₄"
 AUHC Arkshade Dove Mosaico 30x30 - 11³/₄"x11³/₄"
 AUHD Arkshade Grey Mosaico 30x30 - 11³/₄"x11³/₄"
 AUHE Arkshade Lead Mosaico 30x30 - 11³/₄"x11³/₄"



AUII Arkshade White Mosaico Art 3D * 35,4x35,4 - 14"x14"
 AUIJ Arkshade Clay Mosaico Art 3D * 35,4x35,4 - 14"x14"
 AUIK Arkshade Dove Mosaico Art 3D * 35,4x35,4 - 14"x14"
 AUIL Arkshade Grey Mosaico Art 3D * 35,4x35,4 - 14"x14"
 AUIM Arkshade Lead Mosaico Art 3D * 35,4x35,4 - 14"x14"

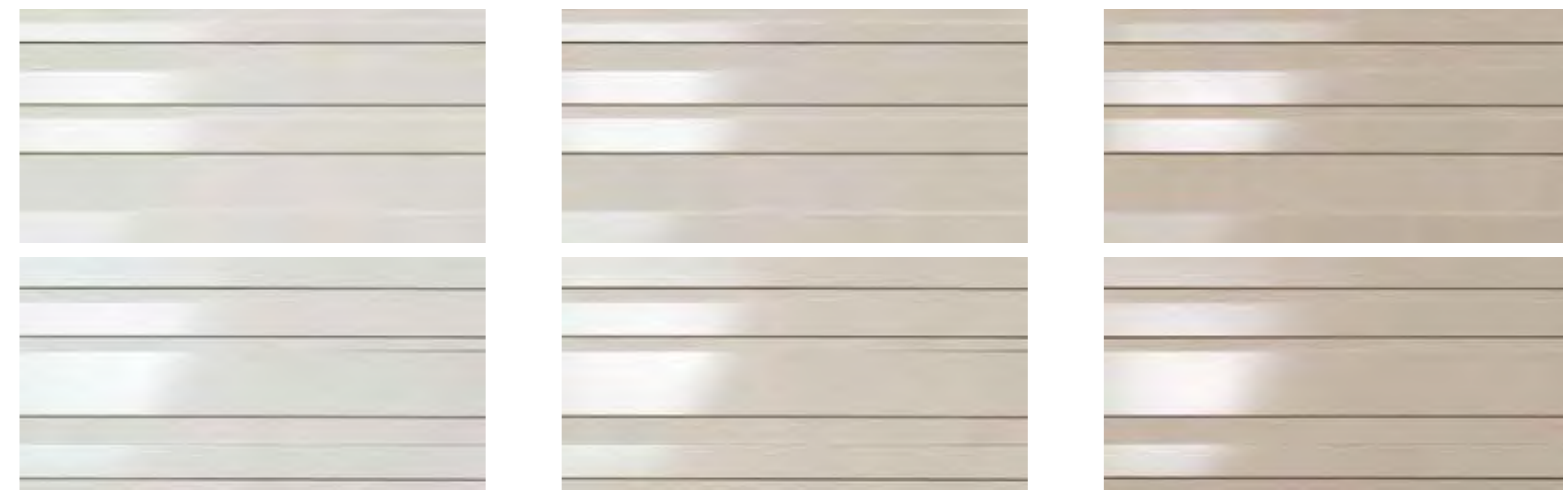

AUH0 Arkshade White Mosaico Linea 3D * 30x60 - 11³/₄"x23⁵/₈"
 AUH1 Arkshade Clay Mosaico Linea 3D * 30x60 - 11³/₄"x23⁵/₈"
 AUH2 Arkshade Dove Mosaico Linea 3D * 30x60 - 11³/₄"x23⁵/₈"



AUH3 Arkshade Grey Mosaico Linea 3D * 30x60 - 11³/₄"x23⁵/₈"
 AUH4 Arkshade Lead Mosaico Linea 3D * 30x60 - 11³/₄"x23⁵/₈"

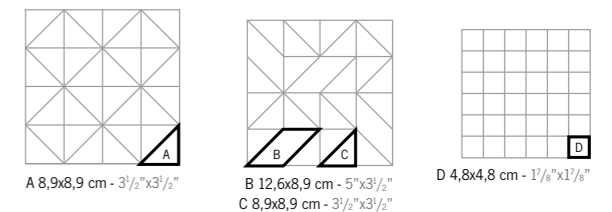

* MULTI-THICKNESS MOSAIC, CLOSE JOINT INSTALLATION WITHOUT GROUTING.
 MOSAICO MULTISPESORE, POSA SENZA STUCCATURA A GIUNTO UNITO.
 Mosaïque multi-épaisseur, pose sans mastic avec joint nul.
 Mosaik mit verschieden Stärken, fugenlose Verlegung ohne Mörtel.
 Mosaico multiespesor, colocación sin mástique y sin juntas.
 Мозаика разной толщины; укладка встык без затирки швов.

THE DECORATION CAN ONLY BE LAID ON THE WALL | IL DECORO SI PUÒ POSARE SOLO A RIVESTIMENTO
 Décor uniquement mural | Das Dekor kann nur an der Wand verlegt werden | La decoración se puede colocar únicamente en paredes | Декор может быть уложен только на стену.

ARKSHADE Porcelain Tiles / Gres Porcellanato

DECOR RANGE / GAMMA DECORI



AUH5 Arkshade White Brick
30x60 - 11³/₄"x23⁵/₈"



AUH8 Arkshade Grey Brick
30x60 - 11³/₄"x23⁵/₈"



AUH6 Arkshade Clay Brick
30x60 - 11³/₄"x23⁵/₈"



AUH9 Arkshade Lead Brick
30x60 - 11³/₄"x23⁵/₈"



AUH7 Arkshade Dove Brick
30x60 - 11³/₄"x23⁵/₈"

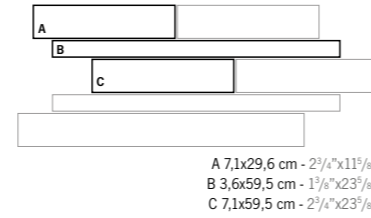

AUG5 Arkshade White Listello 8x60
8x60 - 3¹/₈"x23⁵/₈"

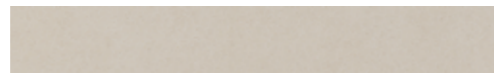

AUG6 Arkshade Clay Listello 8x60
8x60 - 3¹/₈"x23⁵/₈"



AUG7 Arkshade Dove Listello 8x60
8x60 - 3¹/₈"x23⁵/₈"



AUG8 Arkshade Grey Listello 8x60
8x60 - 3¹/₈"x23⁵/₈"



AUG9 Arkshade Lead Listello 8x60
8x60 - 3¹/₈"x23⁵/₈"

TRIM TILES / PEZZI SPECIALI

p. 568

		Battiscopa 7,2x60 2 ⁷ / ₈ "x23 ⁵ / ₈ "	Battiscopa Lappato 7,2x60 2 ⁷ / ₈ "x23 ⁵ / ₈ "	Gradino * 30x60 11 ³ / ₄ "x23 ⁵ / ₈ "	Scalino * 33x150 13"x59"	Scalino * 33x60 13"x23 ⁵ / ₈ "	Scalino Angolare * 33x33 13"x13"	Battiscopa Sag. Scala 7,2x30 - 2 ⁷ / ₈ "x11 ⁵ / ₈ "		Elemento L Grip * 15x60 H. 4 5 ⁷ / ₈ "x23 ⁵ / ₈ " H. 1 ⁵ / ₈ "
		DX *	SX *							
	White	AUIU	AUIP	AUI9	A8KA	AUJE	AUJT	AUIZ	AUI4	A8J5
	Clay	AUIV	AUIQ	AUJA	A8KB	AUJF	AUJU	AUIØ	AUI5	A8J6
	Dove	AUIW	AUIR	AUJB	A8KC	AUJG	AUJV	AUI1	AUI6	A8J7
	Grey	AUIX	AUIS	AUJC	A8KD	AUJH	AUJW	AUI2	AUI7	A8J8
	Lead	AUIY	AUIT	AUJD	A8KE	AUJI	AUJX	AUI3	AUI8	A8J9

* THESE PARTS ARE SUPPLIED TO ORDER . I PEZZI SONO DISPONIBILI SU ORDINAZIONE I Les pièces sont disponibles sur commande I Die Teile sind auf Bestellung lieferbar I Las piezas se hacen por encargo I Изготавливаются на заказ

UPEC p. 595





ARKSHADE

WALL TILES



Wall Tiles / Rivestimento

WHITEBODY WALL TILES - RECTIFIED MONOCALIBER
RIVESTIMENTI IN PASTA BIANCA - RETTIFICATO MONOCALIBRO

Sizes	Thickness	Surface finish
40x80 cm - 15 ³ / ₄ "x31 ¹ / ₂ "	± 8,5 mm	Matte

3D Wall Tiles

Sizes	Thickness	Surface finish
40x80 cm - 15 ³ / ₄ "x31 ¹ / ₂ "	± 10 mm	Matte

DECORATIVE RANGE / GAMMA DECORATIVA

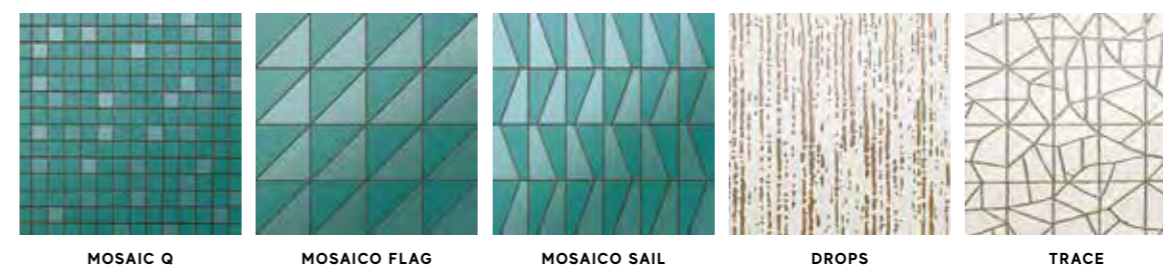

ARKSHADE Wall Tiles / Rivestimento

MATTE SURFACE / SUPERFICIE MATT



8DSO Solid White Matt
40x80 - 15³/₄"x31¹/₂"



8AKL Arkshade Light Clay 40X80
40x80 - 15³/₄"x31¹/₂"



8AKV Arkshade Light Dove 40X80
40x80 - 15³/₄"x31¹/₂"

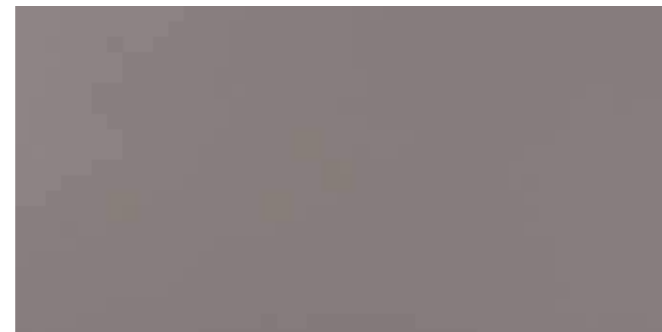

8AKE Arkshade Deep Grey 40X80
40x80 - 15³/₄"x31¹/₂"

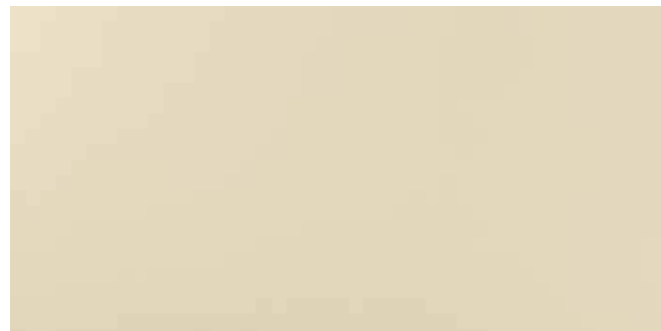

8AKA Arkshade Cream 40X80
40x80 - 15³/₄"x31¹/₂"

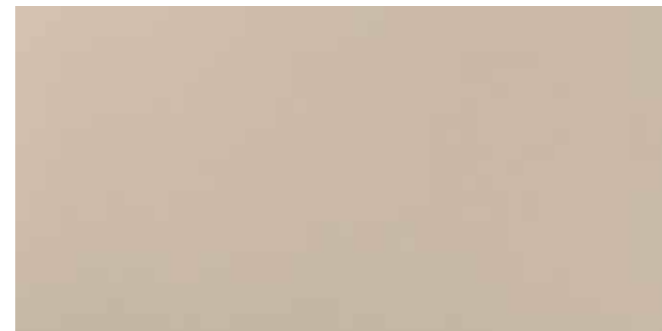

8AKP Arkshade Taupe 40X80
40x80 - 15³/₄"x31¹/₂"



8AKF Arkshade Sage 40X80
40x80 - 15³/₄"x31¹/₂"



8AKH Arkshade Sky 40X80
40x80 - 15³/₄"x31¹/₂"



8AKN Arkshade Gemstone 40X80
40x80 - 15³/₄"x31¹/₂"



8AKU Arkshade Blue 40X80
40x80 - 15³/₄"x31¹/₂"









8AKW Arkshade Yellow 40X80
40x80 - 15³/₄"x31¹/₂"













8AKD Arkshade Red 40X80
40x80 - 15³/₄"x31¹/₂"

TRIM TILES / PEZZI SPECIALI

 LD8W Spigolo 8,5 mm White Matt 0,8x20 cm - ³ / ₈ "x7 ⁷ / ₈ "	 A8DW Spigolo 8,5 mm A.E. 0,8x0,8 cm - ³ / ₈ "x ³ / ₈ "
 LAKD Arkshade Light Dove Spigolo 0,8x20 cm - ³ / ₈ "x7 ⁷ / ₈ "	 AAKD Arkshade Light Dove Spigolo A.E. 0,8x0,8 cm - ³ / ₈ "x ³ / ₈ "
 LAKE Arkshade Cream Spigolo 0,8x20 cm - ³ / ₈ "x7 ⁷ / ₈ "	 AAKE Arkshade Cream Spigolo A.E. 0,8x0,8 cm - ³ / ₈ "x ³ / ₈ "

 LAKC Arkshade Light Clay Spigolo 0,8x20 cm - ³ / ₈ "x7 ⁷ / ₈ "	 AAKC Arkshade Light Clay Spigolo A.E. 0,8x0,8 cm - ³ / ₈ "x ³ / ₈ "
 LAKG Arkshade Deep Grey Spigolo 0,8x20 cm - ³ / ₈ "x7 ⁷ / ₈ "	 AAKF Arkshade Deep Grey Spigolo A.E. 0,8x0,8 cm - ³ / ₈ "x ³ / ₈ "
 LAKT Arkshade Taupe Spigolo 0,8x20 cm - ³ / ₈ "x7 ⁷ / ₈ "	 AAKT Arkshade Taupe Spigolo A.E. 0,8x0,8 cm - ³ / ₈ "x ³ / ₈ "

TRIM TILES / PEZZI SPECIALI

 LAKS Arkshade Sage Spigolo 0,8x20 cm - ³ / ₈ "x7 ⁷ / ₈ "	 AAKS Arkshade Sage Spigolo A.E. 0,8x0,8 cm - ³ / ₈ "x ³ / ₈ "	 LAKK Arkshade Sky Spigolo 0,8x20 cm - ³ / ₈ "x7 ⁷ / ₈ "	 AAKK Arkshade Sky Spigolo A.E. 0,8x0,8 cm - ³ / ₈ "x ³ / ₈ "
 LAKO Arkshade Gemstone Spigolo 0,8x20 cm - ³ / ₈ "x7 ⁷ / ₈ "	 AAKM Arkshade Gemstone Spigolo A.E. 0,8x0,8 cm - ³ / ₈ "x ³ / ₈ "	 LAKB Arkshade Blue Spigolo 0,8x20 cm - ³ / ₈ "x7 ⁷ / ₈ "	 AAKB Arkshade Blue Spigolo A.E. 0,8x0,8 cm - ³ / ₈ "x ³ / ₈ "
 LAKY Arkshade Yellow Spigolo 0,8x20 cm - ³ / ₈ "x7 ⁷ / ₈ "	 AAKY Arkshade Yellow Spigolo A.E. 0,8x0,8 cm - ³ / ₈ "x ³ / ₈ "	 LAKR Arkshade Red Spigolo 0,8x20 cm - ³ / ₈ "x7 ⁷ / ₈ "	 AAKR Arkshade Red Spigolo A.E. 0,8x0,8 cm - ³ / ₈ "x ³ / ₈ "



V1
UNIFORM
VARIATION

MATTE SURFACE | SUPERFICIE MATT | Surface Mat | Matt oberfläche | Superficie Mate | Матовая поверхность



V1
UNIFORM
VARIATION

MATTE SURFACE | SUPERFICIE MATT | Surface Mat | Matt oberfläche | Superficie Mate | Матовая поверхность

ARKSHADE Wall Tiles / Rivestimento

MATTE SURFACE / SUPERFICIE MATT



8ASC Arkshade 3D Stars Light Clay 40X80
40x80 - 15³/₄"x31¹/₂"



8ASD Arkshade 3D Stars Light Dove 40X80
40x80 - 15³/₄"x31¹/₂"



8ASB Arkshade 3D Stars Blue 40X80
40x80 - 15³/₄"x31¹/₂"

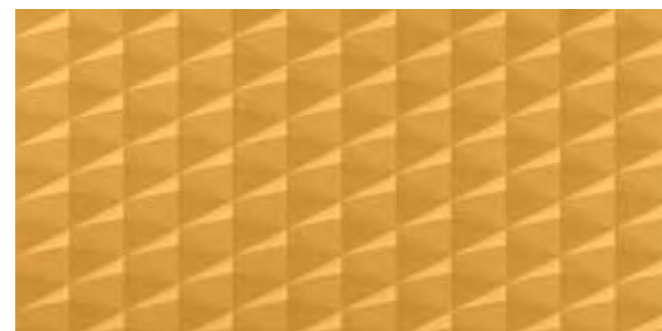

8ASY Arkshade 3D Stars Yellow 40X80
40x80 - 15³/₄"x31¹/₂"

TRIM TILES / PEZZI SPECIALI

L1AC Arkshade Light Clay
Spigolo 10mm
0,8x20 cm - ³/₈"x7⁷/₈"

L1AD Arkshade Light Dove
Spigolo 10mm
0,8x20 cm - ³/₈"x7⁷/₈"

L1AB Arkshade Blue
Spigolo 10mm
0,8x20 cm - ³/₈"x7⁷/₈"

L1AY Arkshade Yellow
Spigolo 10mm
0,8x20 cm - ³/₈"x7⁷/₈"



atlas concorde

ARKSHADE Wall Tiles / Rivestimento

DECOR RANGE / GAMMA DECORI

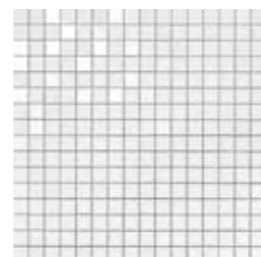

9DSM Solid White Mosaic
30,5x30,5 - 12"x12"

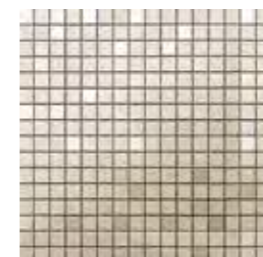

9AQL Arkshade Light Clay
Mosaico Q
30,5x30,5 - 12"x12"

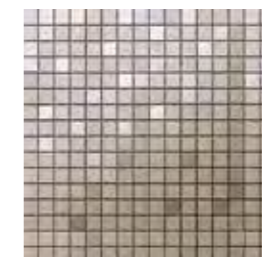

9AQD Arkshade Light Dove
Mosaico Q
30,5x30,5 - 12"x12"

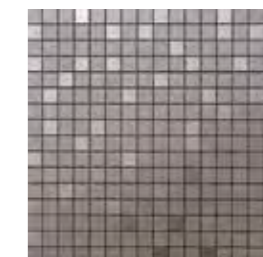

9AQE Arkshade Deep Grey
Mosaico Q
30,5x30,5 - 12"x12"

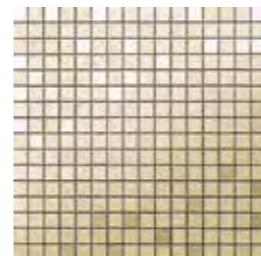

9AQM Arkshade Cream
Mosaico Q
30,5x30,5 - 12"x12"

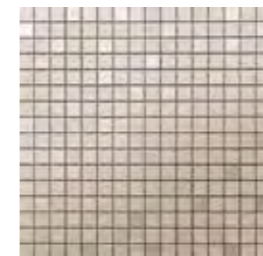

9AQP Arkshade Taupe
Mosaico Q
30,5x30,5 - 12"x12"

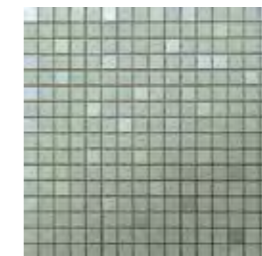

9AQS Arkshade Sage
Mosaico Q
30,5x30,5 - 12"x12"

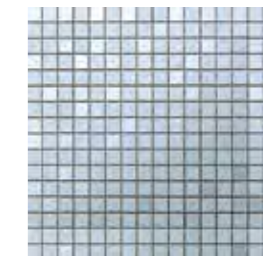

9AQK Arkshade Sky
Mosaico Q
30,5x30,5 - 12"x12"

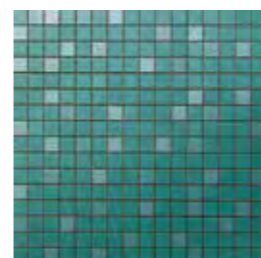

9AQT Arkshade Gemstone
Mosaico Q
30,5x30,5 - 12"x12"

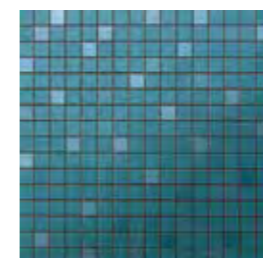

9AQU Arkshade Blue
Mosaico Q
30,5x30,5 - 12"x12"

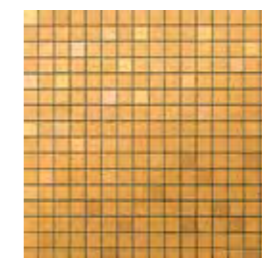

9AQY Arkshade Yellow
Mosaico Q
30,5x30,5 - 12"x12"

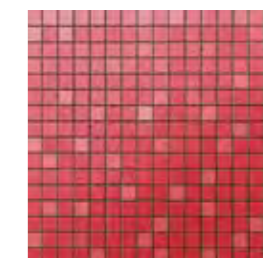

9AQR Arkshade Red
Mosaico Q
30,5x30,5 - 12"x12"



V1
UNIFORM
VARIATION



atlas concorde

The 10 mm edge matches three-dimensional wall tiles having a 10-11 mm thickness / Lo spigolo 10 mm si abbina a rivestimenti tridimensionali di spessore 10-11 mm / Le bord 10 mm s'adapte aux revêtements tridimensionnels épaisseur 10-11 mm / Die 10 mm Kante ist mit dreidimensionalen Wandfliesen mit einer Dicke von 10-11 mm kombinierbar / La arista de 10 mm se combina con revestimientos tridimensionales de 10 -11 mm de grosor / Угловой элемент 10 мм сочетается с трехмерной настенной плиткой толщиной 10-11 мм

MATTE SURFACE | SUPERFICIE MATT | Surface Mat | Matt Oberfläche | Superficie Mate | Матовая поверхность

ARKSHADE Wall Tiles / Rivestimento

DECOR RANGE / GAMMA DECORI



9AFC Arkshade Light Clay
Mosaico Flag
30,5x30,5 - 12"x12"



9AFD Arkshade Light Dove
Mosaico Flag
30,5x30,5 - 12"x12"

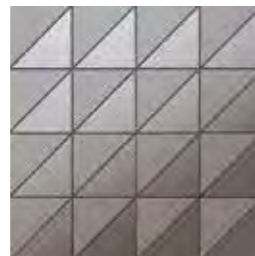

9AFG Arkshade Deep Grey
Mosaico Flag
30,5x30,5 - 12"x12"



9AFE Arkshade Cream
Mosaico Flag
30,5x30,5 - 12"x12"



9AFT Arkshade Taupe
Mosaico Flag
30,5x30,5 - 12"x12"



9AFS Arkshade Sage
Mosaico Flag
30,5x30,5 - 12"x12"

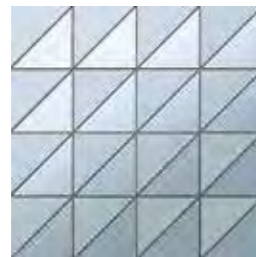

9AFK Arkshade Sky
Mosaico Flag
30,5x30,5 - 12"x12"

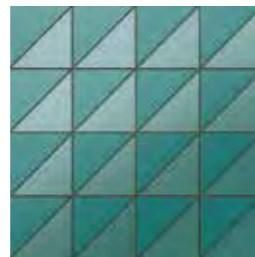

9AFM Arkshade Gemstone
Mosaico Flag
30,5x30,5 - 12"x12"



9AFB Arkshade Blue
Mosaico Flag
30,5x30,5 - 12"x12"

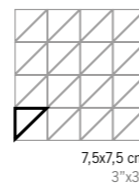

9AAE Arkshade Sage
Mosaico Sail
30,5x30,5 - 12"x12"



9AAK Arkshade Sky
Mosaico Sail
30,5x30,5 - 12"x12"



9AAG Arkshade Gemstone
Mosaico Sail
30,5x30,5 - 12"x12"



9AAB Arkshade Blue
Mosaico Sail
30,5x30,5 - 12"x12"

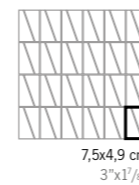

8ADW Arkshade White Drops •
40x80 - 15 3/4"x31 1/2"

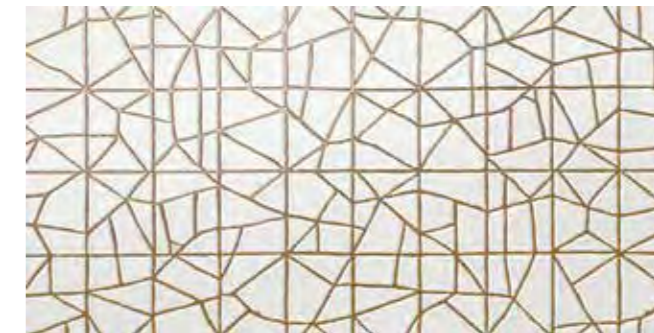

8ATW Arkshade White Trace •
40x80 - 15 3/4"x31 1/2"

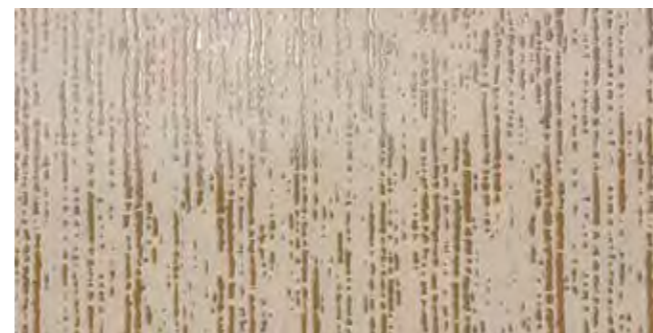

8ADT Arkshade Taupe Drops •
40x80 - 15 3/4"x31 1/2"

• **DECOR WITH GOLD INSERT.**
DECORO CON INSERTO IN ORO.
Décor avec insert en OR.
Dekor mit Einlage GOLD.
Decoración con aplicación de ORO.
Декор с ЗОЛОТОЙ вставкой.





ARTY
WALL TILES



Wall Tiles / Rivestimento

WHITEBODY WALL TILES - RECTIFIED MONOCALIBER
RIVESTIMENTI IN PASTA BIANCA - RETTIFICATO MONOCALIBRO

Sizes	Thickness	Surface finish
40x80 cm - 15 ³ / ₄ "x31 ¹ / ₂ "	± 8,5 mm	Matte

3D Wall Tiles

Sizes	Thickness	Surface finish
40x80 cm - 15 ³ / ₄ "x31 ¹ / ₂ "	± 10 mm	Matte

DECORATIVE RANGE / GAMMA DECORATIVA



MINIBRICK

URBAN C2

TEXTILE



WHITEBODY WALL TILES | RIVESTIMENTI IN PASTA BIANCA | Revêtements en pâte blanche | Weißscherbige Wandfliesen | Revestimientos en pasta blanca | Настенная плитка из белой глины
RECTIFIED MONOCALIBER | RETTIFICATO MONOCALIBRO | Rectifié mono-calibre | Geschliffen einkalibrig | Rectificado monocalibrre | Ретицированный в одном калибре

ARTY Wall Tiles / Rivestimento

MATTE SURFACE / SUPERFICIE MATT



SARU Arty Sugar 40X80
40x80 - 15³/₄"x31¹/₂"



SARL Arty Milk 40X80
40x80 - 15³/₄"x31¹/₂"



SARA Arty Charcoal 40X80
40x80 - 15³/₄"x31¹/₂"



SARN Arty Malt 40X80
40x80 - 15³/₄"x31¹/₂"



SARD Arty Curry 40X80
40x80 - 15³/₄"x31¹/₂"



SARB Arty Tabasco 40X80
40x80 - 15³/₄"x31¹/₂"

TRIM TILES / PEZZI SPECIALI

	LASS Arty Sugar Spigolo 0,8x20 - 3 ¹ / ₈ "x7 ⁷ / ₈ "		AASS Spigolo A.E. 0,8x0,8 - 3 ¹ / ₈ "x3 ¹ / ₈ "
	LASH Arty Charcoal Spigolo 0,8x20 - 3 ¹ / ₈ "x7 ⁷ / ₈ "		AASH Spigolo A.E. 0,8x0,8 - 3 ¹ / ₈ "x3 ¹ / ₈ "
	LASC Arty Curry Spigolo 0,8x20 - 3 ¹ / ₈ "x7 ⁷ / ₈ "		AASU Spigolo A.E. 0,8x0,8 - 3 ¹ / ₈ "x3 ¹ / ₈ "
	LASK Arty Milk Spigolo 0,8x20 - 3 ¹ / ₈ "x7 ⁷ / ₈ "		AASI Spigolo A.E. 0,8x0,8 - 3 ¹ / ₈ "x3 ¹ / ₈ "
	LASD Arty Malt Spigolo 0,8x20 - 3 ¹ / ₈ "x7 ⁷ / ₈ "		AASM Spigolo A.E. 0,8x0,8 - 3 ¹ / ₈ "x3 ¹ / ₈ "
	LASO Arty Tabasco Spigolo 0,8x20 - 3 ¹ / ₈ "x7 ⁷ / ₈ "		AASO Spigolo A.E. 0,8x0,8 - 3 ¹ / ₈ "x3 ¹ / ₈ "

ARTY 3D WALL Tiles / Rivestimento 3D

MATTE SURFACE / SUPERFICIE MATT



8AWS Arty Sugar Wave 40X80
40x80 - 15³/₄"x31¹/₂"

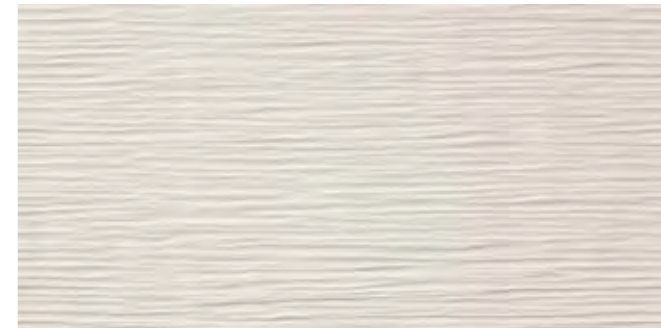

8AWM Arty Milk Wave 40X80
40x80 - 15³/₄"x31¹/₂"

DECOR RANGE / GAMMA DECORI



9ASS Arty Sugar Minibrick
30,5x30,5 - 12"x12"



9ASH Arty Charcoal Minibrick
30,5x30,5 - 12"x12"



9ASC Arty Curry Minibrick
30,5x30,5 - 12"x12"



9ASI Arty Milk Minibrick
30,5x30,5 - 12"x12"



9ASM Arty Malt Minibrick
30,5x30,5 - 12"x12"



9AST Arty Tabasco Minibrick
30,5x30,5 - 12"x12"

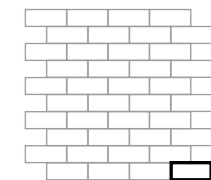

2,8x7,3 cm
1¹/₈"x2⁷/₈"



MATTE SURFACE | SUPERFICIE MATT | Surface Mat | Matt oberfläche | Superficie Mate | Матовая поверхность



V1
UNIFORM
VARIATION



V1
UNIFORM
VARIATION

ARTY Wall Tiles / Rivestimento

DECOR RANGE / GAMMA DECORI



SATM Arty Milk Texture
40x80 - 15³/₄"x31¹/₂"



8ATT Arty Tabasco Texture
40x80 - 15³/₄"x31¹/₂"



8A2S Arty Sugar Urban C2
80x80 - 31¹/₂"x31¹/₂"



8A2C Arty Curry Urban C2
80x80 - 31¹/₂"x31¹/₂"

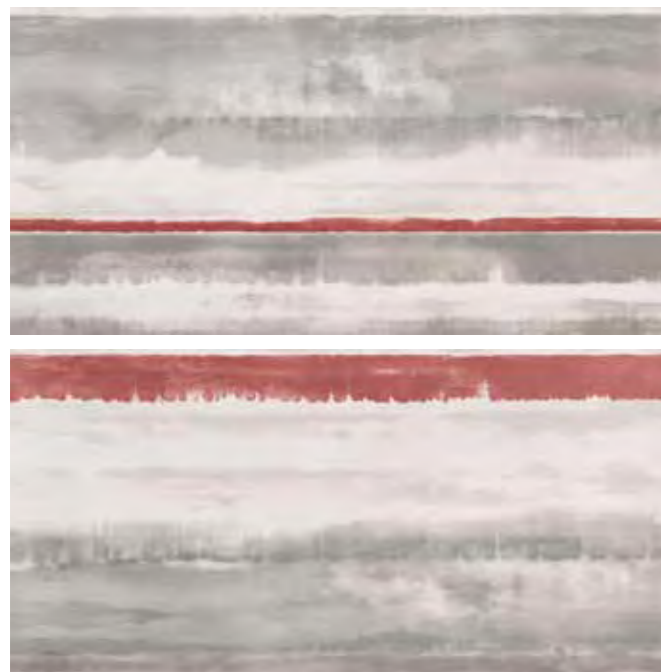

8A2T Arty Tabasco Urban C2
80x80 - 31¹/₂"x31¹/₂"



ARTY Wall tiles / Rivestimento

MATCHING FLOOR / PAVIMENTI CONSIGLIATI

WOOD LOOK	WOOD LOOK					
	Sugar	Milk	Malt	Charcoal	Curry	Tabasco
CONCRETE LOOK	EXENCE					
	Vanilla	Vanilla	Almond	Almond	Amber	Amber
	Almond	Almond	Amber	Amber		
	Amber	Amber				
	HEARTWOOD					
	Malt	Malt	Brandy	Malt	Moka	Moka
	Brandy	Brandy	Moka	Brandy		
		Moka				
	ETIC PRO					
	Rovere Venice	Rovere Venice	Rovere Venice		Rovere Venice	
BOOST PRO						
Clay	Clay	Taupe		Taupe		
Taupe		Tobacco		Tobacco		
BOOST						
White	Pearl	Pearl	White	Pearl	White	
				Smoke	Pearl	
PRISM						
Suede	Suede	Suede	Graphite	Suede	Fog	
Cord				Cord		
Cloud				Fog		
Fog						
DWELL						
Gray					Smoke	
Pearl						



BOOST

PORCELAIN&WALL TILES

Porcelain Tiles / Gres Porcellanato

COLOURED BODY PORCELAIN TILES - RECTIFIED MONOCALIBER
GRES PORCELLANATO COLORATO IN MASSA - RETTIFICATO MONOCALIBRO

LARGE SIZES p. 500

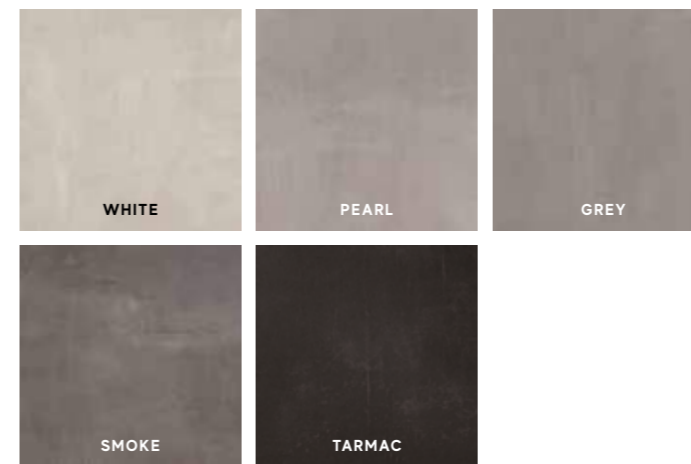

Sizes	Thickness	Surface finish
162x324 cm - 63 ³ / ₄ "x127 ¹ / ₂ " * NON RECTIFIED - NON RETTIFICATO	± 6-12-20 mm	Hammered
160x320 cm - 63"x126"	± 6 mm	Matte R9 A
160x160 cm - 63"x63"	± 6 mm	Matte R9 A
120x278 cm - 47 ¹ / ₄ "x109 ¹ / ₂ "	± 6 mm	Matte R9 A
120x240 cm - 47 ¹ / ₄ "x94 ¹ / ₂ "	± 9 mm	Matte R10 A+B
120x120 cm - 47 ¹ / ₄ "x47 ¹ / ₄ "	± 6 mm ± 9 mm	Matte R9 A Matte R10 A+B
75x150 cm - 29 ¹ / ₂ "x59"	± 9 mm	Matte R10 A+B
60x120 cm - 23 ⁵ / ₈ "x47 ¹ / ₄ "	± 9 mm	Matte R10 A+B
75x75 cm - 29 ¹ / ₂ "x29 ¹ / ₂ "	± 9 mm	Matte R10 A+B
37,5x75 cm - 14 ³ / ₄ "x29 ¹ / ₂ "	± 9 mm	Matte R10 A+B
60x60 cm - 23 ⁵ / ₈ "x23 ⁵ / ₈ "	± 9 mm	Matte R10 A+B
30x60 cm - 11 ³ / ₄ "x23 ⁵ / ₈ "	± 9 mm	Matte R10 A+B

Outdoor Paving and Wet Areas

OUTDOOR PAVING p. 554

Sizes	Thickness	Surface finish
120x120 cm - 47 ¹ / ₄ "x47 ¹ / ₄ "	± 9 mm	Grip R11 A+B+C
120x240 cm - 47 ¹ / ₄ "x94 ¹ / ₂ "	± 20 mm	Textured R11 A+B+C
120x120 cm - 47 ¹ / ₄ "x47 ¹ / ₄ "	± 20 mm	Textured R11 A+B+C
60x120 cm - 23 ⁵ / ₈ "x47 ¹ / ₄ "	± 20 mm	Textured R11 A+B+C
90x90 cm - 35 ³ / ₈ "x35 ³ / ₈ "	± 20 mm	Textured R11 A+B+C
60x60 cm - 23 ⁵ / ₈ "x23 ⁵ / ₈ "	± 20 mm	Textured R11 A+B+C



Wall Tiles / Rivestimento

WHITEBODY WALL TILES - RECTIFIED MONOCALIBER
RIVESTIMENTI IN PASTA BIANCA - RETTIFICATO MONOCALIBRO

Sizes	Thickness	Surface finish
40x80 cm - 15 ³ / ₄ "x31 ¹ / ₂ "	± 8,5 mm	Matte

3D Wall Tiles

Sizes	Thickness	Surface finish
40x80 cm - 15 ³ / ₄ "x31 ¹ / ₂ "	± 10 mm	Matte

BOOST Porcelain Tiles / Gres Porcellanato

MATTE SURFACE / SUPERFICIE MATT



HAMMERED / HAMMERED
162x324 cm 63³/₄"x127¹/₂"
 > **NON RECTIFIED / NON RETTIFICATO**
 AN1M Boost White Hammered ± 6 mm ST *
 AN1O Boost Smoke Hammered ± 6 mm ST *
 ANVX Boost White Hammered ± 12 mm ST *
 ANVØ Boost Smoke Hammered ± 12 mm ST *
 A2XV Boost Smoke Hammered ± 20 mm

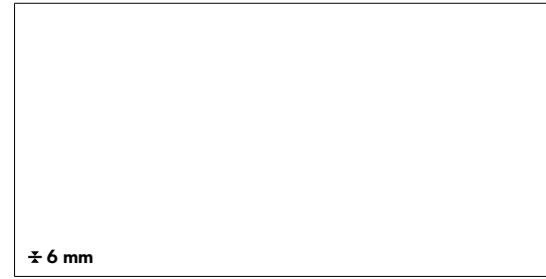

160x320 cm 63"x126"
 A05Z Boost White 160x320RT
 A05Ø Boost Smoke 160x320RT

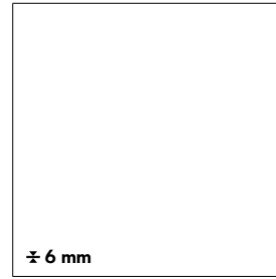

160x160 cm 63"x63"
 A0DE Boost White 160x160RT
 A0DF Boost Smoke 160x160RT



120x278 cm 47¹/₄"x109¹/₂"
 A0BD Boost White 120x278
 A0BE Boost Pearl 120x278
 A0BF Boost Grey 120x278
 A0BG Boost Smoke 120x278
 A0QB Boost Tarmac 120x278

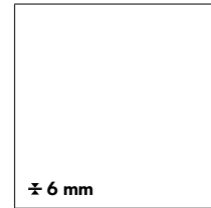

120x120 cm 47¹/₄"x47¹/₄"
 A2TK Boost White 120x120 6mm
 A2TM Boost Pearl 120x120 6mm
 A2TN Boost Grey 120x120 6mm
 A2TO Boost Smoke 120x120 6mm
 A2TP Boost Tarmac 120x120 6mm



120x240 cm 47¹/₄"x94¹/₂"
 AMGD Boost White 120x240
 AMGE Boost Pearl 120x240
 AMGF Boost Grey 120x240
 AMGG Boost Smoke 120x240
 AMGH Boost Tarmac 120x240

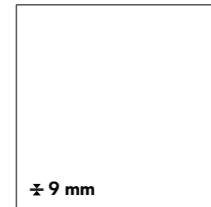

120x120 cm 47¹/₄"x47¹/₄"
 AMGI Boost White 120x120
 AMGJ Boost Pearl 120x120
 AMGK Boost Grey 120x120
 AMGL Boost Smoke 120x120
 AMGM Boost Tarmac 120x120

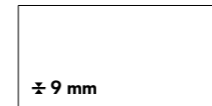

60x120 cm 23³/₈"x47¹/₄"
 A0MO Boost White 60x120
 A0MP Boost Pearl 60x120
 A0MQ Boost Grey 60x120
 A0MR Boost Smoke 60x120
 A0MS Boost Tarmac 60x120



75x150 cm 29¹/₂"x59"
 AME4 Boost White 75x150
 AME5 Boost Pearl 75x150
 AMGS Boost Grey 75x150
 AMGT Boost Smoke 75x150
 AMGU Boost Tarmac 75x150

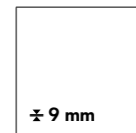

75x75 cm 29¹/₂"x29¹/₂"
 AME6 Boost White 75x75
 AME7 Boost Pearl 75x75
 AMGV Boost Grey 75x75
 AMGW Boost Smoke 75x75
 AMGX Boost Tarmac 75x75

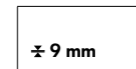

37,5x75 cm 14³/₈"x29¹/₂"
 A0N8 Boost White 37,5x75
 A0N9 Boost Pearl 37,5x75
 A0OA Boost Grey 37,5x75
 A0OB Boost Smoke 37,5x75
 A0OC Boost Tarmac 37,5x75

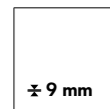

60x60 cm 23³/₈"x23³/₈"
 AMH3 Boost White 60x60
 AMH4 Boost Pearl 60x60
 AMH5 Boost Grey 60x60
 AMH6 Boost Smoke 60x60
 AMH7 Boost Tarmac 60x60

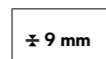

30x60 cm 11³/₄"x23³/₈"
 AMH8 Boost White 30x60
 AMH9 Boost Pearl 30x60
 AMIA Boost Grey 30x60
 AMIC Boost Smoke 30x60
 AMID Boost Tarmac 30x60

MATTE SURFACE | SUPERFICIE MATT | Surface Mat | Matt oberfläche | Superficie Mate | Матовая поверхность

* WITH FIBERGLASS MESH | VERSIONE STUOIATA | Version à nattes | Ausführung mit Glasfasermatte | Versión con malla | С упрочнением из стекловолоконка
 NON RECTIFIED | NON RETTIFICATO | Non rectifié | Nicht rektifiziert | No rectificada | Неретифицированные



V3
 MODERATE
 VARIATION



WHITE



PEARL



GREY

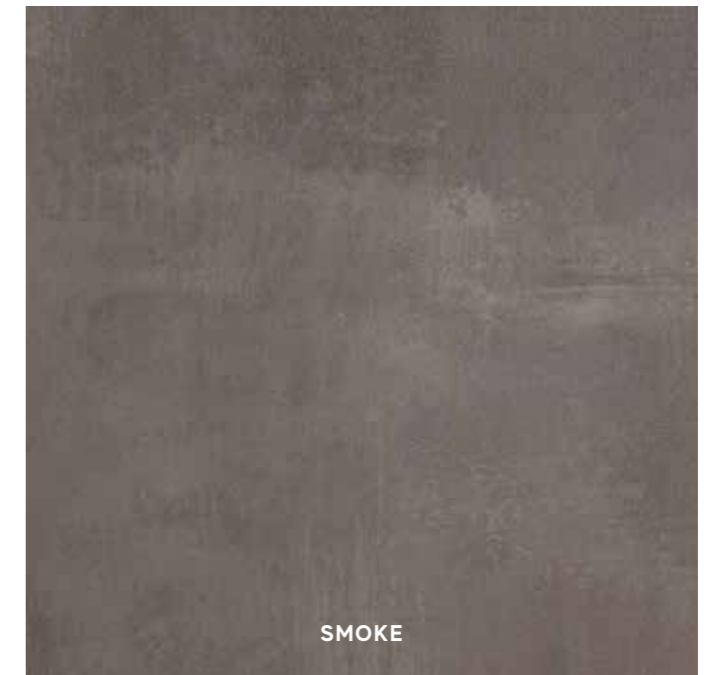

SMOKE

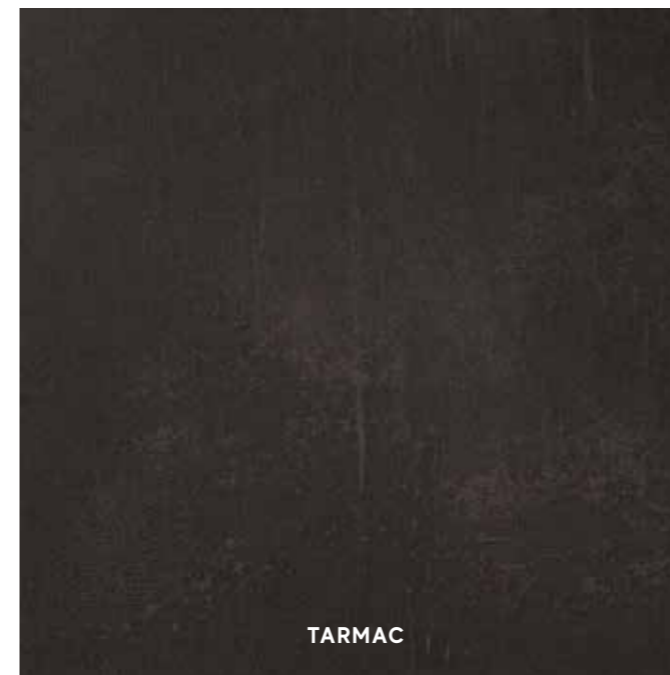

TARMAC

BOOST Porcelain Tiles / Gres Porcellanato

GRIP SURFACE / SUPERFICIE GRIP

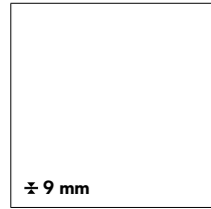

120x120 cm 47¹/₄"x47¹/₄"

AMGN Boost White 120x120 Grip
AMGO Boost Pearl 120x120 Grip
AMGP Boost Grey 120x120 Grip
AMGQ Boost Smoke 120x120 Grip
AMGR Boost Tarmac 120x120 Grip

OUTDOOR PAVING ± 20 mm / PAVIMENTI DA ESTERNO ± 20 mm

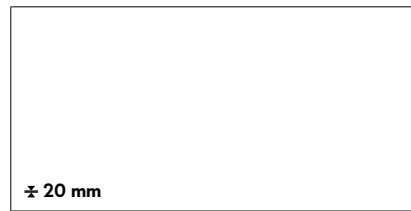

120x240 cm 47¹/₄"x94¹/₂"

A2R0 Boost White 120x240 20mm
A2R9 Boost Grey 120x240 20mm

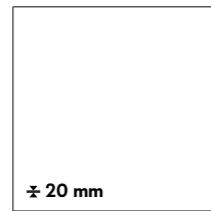

120x120 cm 47¹/₄"x47¹/₄"

AMG3 Boost White 120x120 Lastra 20 mm
AMG5 Boost Grey 120x120 Lastra 20 mm
AMG6 Boost Smoke 120x120 Lastra 20 mm
AMG7 Boost Tarmac 120x120 Lastra 20 mm



60x120 cm 23⁵/₈"x47¹/₄"

AL80 Boost White 60x120 Lastra 20 mm
AL81 Boost Grey 60x120 Lastra 20 mm
AL82 Boost Smoke 60x120 Lastra 20 mm
AL83 Boost Tarmac 60x120 Lastra 20 mm

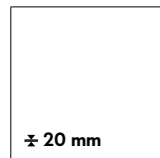

90x90 cm 35⁵/₈"x35⁵/₈"

AMB0 Boost White 90x90 Lastra 20 mm
AMB1 Boost Grey 90x90 Lastra 20 mm
AMB2 Boost Smoke 90x90 Lastra 20 mm
AMCK Boost Tarmac 90x90 Lastra 20 mm

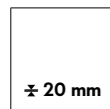

60x60 cm 23⁵/₈"x23⁵/₈"

A3TJ Boost White 60x60 20 mm
A3TK Boost Grey 60x60 20 mm
A3TL Boost Smoke 60x60 20 mm
A3TM Boost Tarmac 60x60 20 mm

GRIP / OUTDOOR PAVING ± 20 mm



WHITE



PEARL



GREY

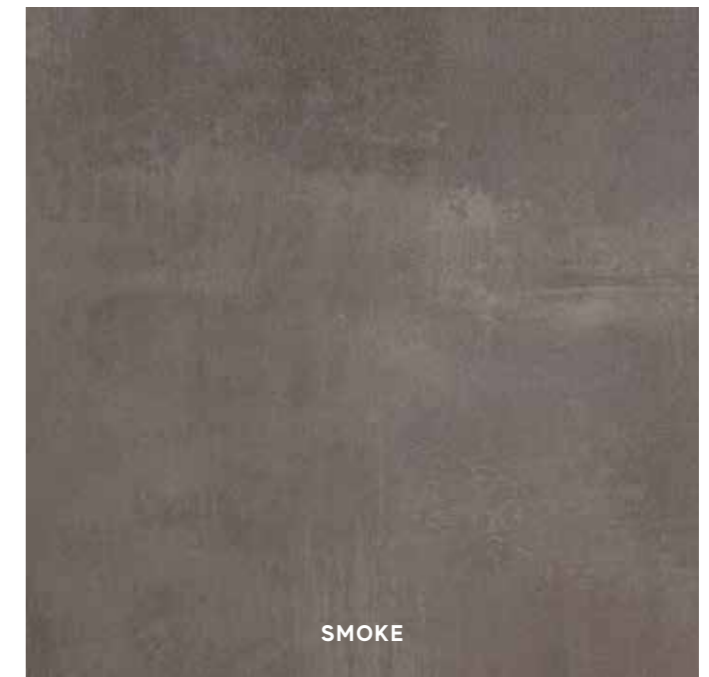

SMOKE

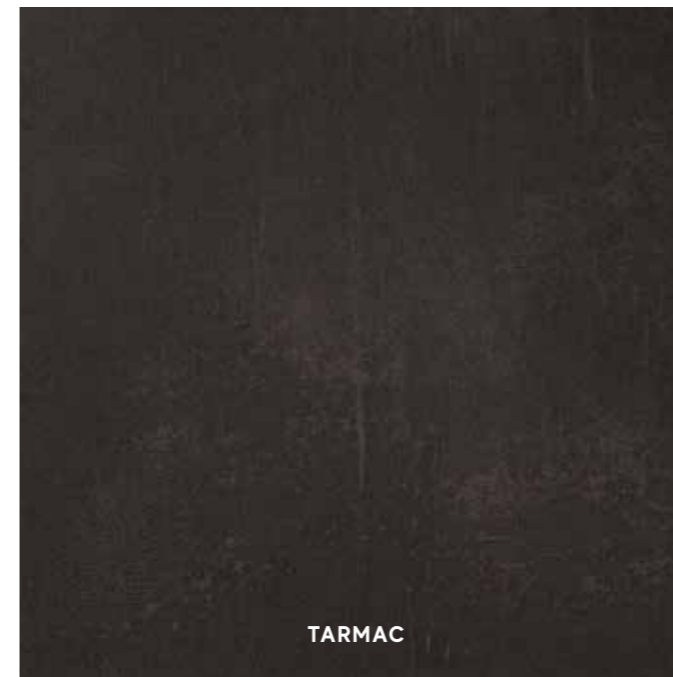

TARMAC



V3
MODERATE
VARIATION

BOOST Porcelain Tiles / Gres Porcellanato

DECOR RANGE / GAMMA DECORI

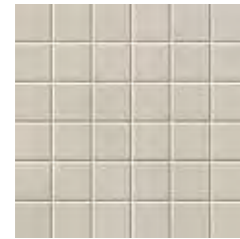

AN6X Boost White Mosaico
30x30 - 11³/₄"x11³/₄"



AN6Y Boost Pearl Mosaico
30x30 - 11³/₄"x11³/₄"

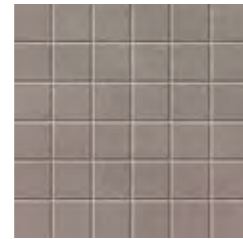

AN6Z Boost Grey Mosaico
30x30 - 11³/₄"x11³/₄"

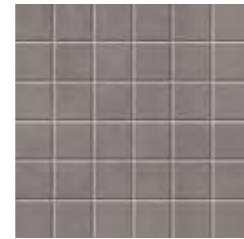

AN61 Boost Smoke Mosaico
30x30 - 11³/₄"x11³/₄"



AN62 Boost Tarmac Mosaico
30x30 - 11³/₄"x11³/₄"

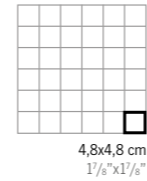

AN63 Boost White Mosaico Shapes
31x33,5 - 12¹/₄"x13³/₄"



AN64 Boost Pearl Mosaico Shapes
31x33,5 - 12¹/₄"x13³/₄"



AN65 Boost Grey Mosaico Shapes
31x33,5 - 12¹/₄"x13³/₄"



AN66 Boost Smoke Mosaico Shapes
31x33,5 - 12¹/₄"x13³/₄"



AN67 Boost Tarmac Mosaico Shapes
31x33,5 - 12¹/₄"x13³/₄"

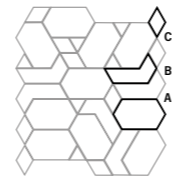

A 11,4x6,5 cm - 4¹/₂"x2¹/₂"
B 11,4x6,5 cm - 4¹/₂"x2¹/₂"
C 6,3x3,2 cm - 2¹/₂"x1¹/₄"

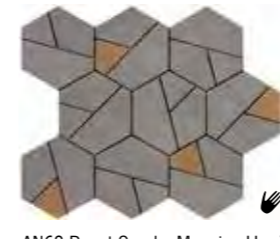

AN68 Boost Smoke Mosaico Hex Yellow
25x28,5 - 9⁷/₈"x11¹/₄"

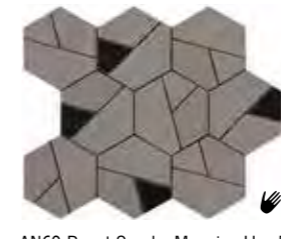

AN69 Boost Smoke Mosaico Hex Black
25x28,5 - 9⁷/₈"x11¹/₄"



AN7A Boost Tarmac Mosaico Hex Jade
25x28,5 - 9⁷/₈"x11¹/₄"



AN7B Boost Tarmac Mosaico Hex Black
25x28,5 - 9⁷/₈"x11¹/₄"

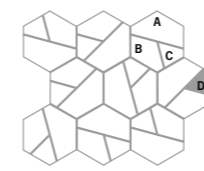

A 9,7x3,8 cm - 3⁷/₈"x1¹/₂"
B 4,8x3,8 cm - 1⁷/₈"x1¹/₂"
C 4,6x3,6 cm - 1¹/₄"x1¹/₂"
D 4,6x3,6 cm - 1¹/₄"x1¹/₂"



TRIM TILES / PEZZI SPECIALI

p. 568

UPEC p. 595

		Battiscopa 7,2x60 2 ⁷ / ₈ "x23 ⁵ / ₈ "	Battiscopa Digitale 4,6x60 1 ³ / ₄ "x23 ⁵ / ₈ "	Gradino * 30x60 11 ³ / ₄ "x23 ⁵ / ₈ "	Scalino * 33x150 13"x59"	Scalino * 33x120 13"x47 ¹ / ₄ "	Scalino * 33x60 13"x23 ⁵ / ₈ "	Scalino Angolare * 33x33 13"x13"	Battiscopa Sag. Scala 7,2x30 - 2 ⁷ / ₈ "x11 ³ / ₄ "		Elemento L Grip 33x120 H.4 cm 13"x47 ¹ / ₄ " H.1 ⁵ / ₈ "
		DX *	SX *								
	White	AMIO	AMIU	AMJA	AMJP	AN7Ø	AMJF	AMJK	AMIZ	AMI5	AOEI
	Pearl	AMIQ	AMIV	AMJB	AMJQ	AN71	AMJG	AMJL	AMIØ	AMI6	AOEJ
	Grey	AMIR	AMIW	AMJC	AMJR	AN72	AMJH	AMJM	AMI1	AMI7	AOEK
	Smoke	AMIS	AMIX	AMJD	AMJS	AN73	AMJI	AMJN	AMI3	AMI8	AOEL
	Tarmac	AMIT	AMIY	AMJE	AMJT	AN74	AMJJ	AMJO	AMI4	AMI9	AOEM

* THESE PARTS ARE SUPPLIED TO ORDER | I PEZZI SONO DISPONIBILI SU ORDINAZIONE | Les pièces sont disponibles sur commande | Die Teile sind auf Bestellung lieferbar | Las piezas se hacen por encargo | Изготавливаются на заказ

THE DECORATION CAN ONLY BE LAID ON THE WALL | IL DECORO SI PUÒ POSARE SOLO A RIVESTIMENTO
Décor uniquement mural | Das Dekor kann nur an der Wand verlegt werden | La decoración se puede colocar únicamente en paredes | Декор может быть уложен только на стену.



atlas concorde

BOOST

WALL TILES



Wall Tiles / Rivestimento

WHITEBODY WALL TILES - RECTIFIED MONOCALIBER
RIVESTIMENTI IN PASTA BIANCA - RETTIFICATO MONOCALIBRO

Sizes	Thickness	Surface finish
40x80 cm - 15 ³ / ₄ "x31 ¹ / ₂ "	± 8,5 mm	Matte

3D Wall Tiles

Sizes	Thickness	Surface finish
40x80 cm - 15 ³ / ₄ "x31 ¹ / ₂ "	± 10 mm	Matte

DECORATIVE RANGE / GAMMA DECORATIVA



MINIBRICK



atlas concorde

BOOST Wall Tiles / Rivestimento

MATTE SURFACE / SUPERFICIE MATT



8B8W Boost White 40x80
40x80 - 15³/₄"x31¹/₂"



8B8P Boost Pearl 40x80
40x80 - 15³/₄"x31¹/₂"



8B8G Boost Grey 40x80
40x80 - 15³/₄"x31¹/₂"



8B8K Boost Smoke 40x80
40x80 - 15³/₄"x31¹/₂"



8B8S Boost Sage 40x80
40x80 - 15³/₄"x31¹/₂"



8B8R Boost Red 40x80
40x80 - 15³/₄"x31¹/₂"

TRIM TILES / PEZZI SPECIALI

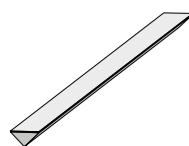

1,4x40 cm - 5/8"x15³/₄"
LBBW Boost White Corner 40 •
LBBP Boost Pearl Corner 40 •
LBBY Boost Grey Corner 40 •
LBBH Boost Smoke Corner 40 •
LBBT Boost Sage Corner 40 •
LBBQ Boost Red Corner 40 •



1,4x1,4 cm - 5/8"x5/8"
A0AW Boost White Corner A.E. •
A0AP Boost Pearl Corner A.E. •
A0AG Boost Grey Corner A.E. •
A0AK Boost Smoke Corner A.E. •
A0AS Boost Sage Corner A.E. •
A0AR Boost Red Corner A.E. •

3D TRIM TILES / PEZZI SPECIALI 3D

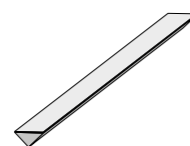

1,4x40 cm - 5/8"x15³/₄"
LB3W Boost White 3D Corner 40 •
LB3P Boost Pearl 3D Corner 40 •
LB3G Boost Grey 3D Corner 40 •

* THESE PARTS ARE SUPPLIED TO ORDER . I PEZZI SONO DISPONIBILI SU ORDINAZIONE
Les pièces sont disponibles sur commande | Die Teile sind auf Bestellung lieferbar | Las piezas se hacen por encargo | Изготавливаются на заказ

MATTE SURFACE | SUPERFICIE MATT | Surface Mat | Matt oberfläche | Superficie Mate | Матовая поверхность



BOOST 3D Wall Tiles / Rivestimento 3D

MATTE SURFACE / SUPERFICIE MATT



8BUW Boost 3D Urban White 40x80
40x80 - 15³/₄"x31¹/₂"



8BUP Boost 3D Urban Pearl 40x80
40x80 - 15³/₄"x31¹/₂"

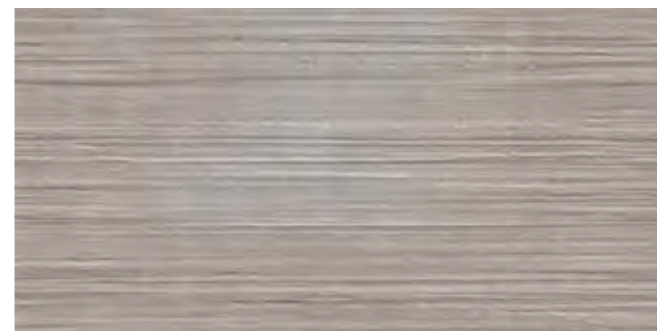

8BUG Boost 3D Urban Grey 40x80
40x80 - 15³/₄"x31¹/₂"

DECOR RANGE / GAMMA DECORI



9BMW Boost White Minibrick
30,5x30,5 - 12"x12"



9BME Boost Pearl Minibrick
30,5x30,5 - 12"x12"



9BMY Boost Grey Minibrick
30,5x30,5 - 12"x12"



9BMK Boost Smoke Minibrick
30,5x30,5 - 12"x12"



9BMM Boost Sage Minibrick
30,5x30,5 - 12"x12"



9BMQ Boost Red Minibrick
30,5x30,5 - 12"x12"

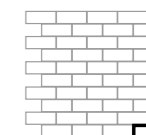

2,9x7,5 cm
1¹/₈"x3"



V2
SLIGHT
VARIATION

MATTE SURFACE | SUPERFICIE MATT | Surface Mat | Matt oberfläche | Superficie Mate | Матовая поверхность



V2
SLIGHT
VARIATION



atlas concorde

BOOST PRO

PORCELAIN&WALL TILES



Porcelain Tiles / Gres Porcellanato

COLOURED BODY PORCELAIN TILES - RECTIFIED MONOCALIBER
GRES PORCELLANATO COLORATO IN MASSA - RETTIFICATO MONOCALIBRO

LARGE SIZES p. 500

Sizes	Thickness	Surface finish
160x320 cm - 63"x126"	± 6 mm	Matte R9 A
160x160 cm - 63"x63"	± 6 mm	Matte R9 A
120x278 cm - 47 ¹ / ₄ "x109 ¹ / ₂ "	± 6 mm	Matte R9 A
120x240 cm - 47 ¹ / ₄ "x94 ¹ / ₂ "	± 9 mm	Matte R10 A+B
120x120 cm - 47 ¹ / ₄ "x47 ¹ / ₄ "	± 6 mm ± 9 mm	Matte R9 A Matte R10 A+B
75x150 cm - 29 ¹ / ₂ "x59"	± 9 mm	Matte R10 A+B
60x120 cm - 23 ⁵ / ₈ "x47 ¹ / ₄ "	± 9 mm	Matte R10 A+B
75x75 cm - 29 ¹ / ₂ "x29 ¹ / ₂ "	± 9 mm	Matte R10 A+B
37,5x75 cm - 14 ³ / ₄ "x29 ¹ / ₂ "	± 9 mm	Matte R10 A+B
60x60 cm - 23 ⁵ / ₈ "x23 ⁵ / ₈ "	± 9 mm	Matte R10 A+B
30x60 cm - 11 ³ / ₄ "x23 ⁵ / ₈ "	± 9 mm	Matte R10 A+B

Outdoor Paving and Wet Areas

OUTDOOR PAVING p. 554

Sizes	Thickness	Surface finish
120x120 cm - 47 ¹ / ₄ "x47 ¹ / ₄ "	± 9 mm	Grip R11 A+B+C
120x120 cm - 47 ¹ / ₄ "x47 ¹ / ₄ "	± 20 mm	Textured R11 A+B+C
60x120 cm - 23 ⁵ / ₈ "x47 ¹ / ₄ "	± 20 mm	Textured R11 A+B+C
90x90 cm - 35 ³ / ₈ "x35 ³ / ₈ "	± 20 mm	Textured R11 A+B+C
60x60 cm - 23 ⁵ / ₈ "x23 ⁵ / ₈ "	± 20 mm	Textured R11 A+B+C



Wall Tiles / Rivestimento

WHITEBODY WALL TILES - RECTIFIED MONOCALIBER
RIVESTIMENTI IN PASTA BIANCA - RETTIFICATO MONOCALIBRO

Sizes	Thickness	Surface finish
40x80 cm - 15 ³ / ₄ "x31 ¹ / ₂ "	± 8,5 mm	Matte

3D Wall Tiles

Sizes	Thickness	Surface finish
40x80 cm - 15 ³ / ₄ "x31 ¹ / ₂ "	± 10 mm	Matte

BOOST PRO Porcelain Tiles / Gres Porcellanato

MATTE SURFACE / SUPERFICIE MATT

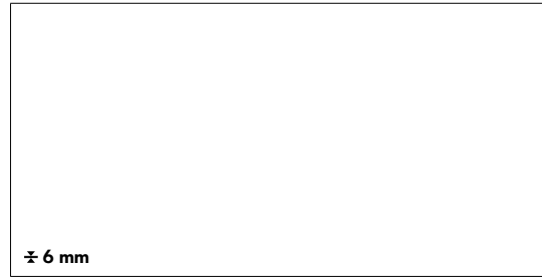

160x320 cm 63"x126"
A0QE Boost Pro Clay 160x320
A0QF Boost Pro Taupe 160x320

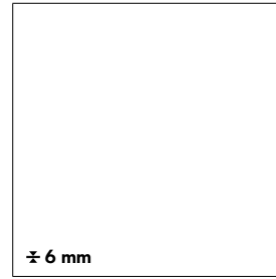

160x160 cm 63"x63"
A0QG Boost Pro Clay 160x160RT
A0QH Boost Pro Taupe 160x160RT



120x278 cm 47 1/4"x109 1/2"
A0CK Boost Pro Ivory 120x278
A0CM Boost Pro Cream 120x278
A0CN Boost Pro Clay 120x278
A0CO Boost Pro Taupe 120x278
A0CP Boost Pro Tobacco 120x278

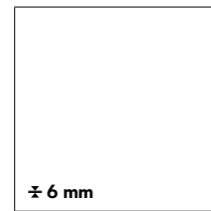

120x120 cm 47 1/4"x47 1/4"
A0CQ Boost Pro Ivory 120x120 6mm
A0CR Boost Pro Cream 120x120 6mm
A0CS Boost Pro Clay 120x120 6mm
A0CT Boost Pro Taupe 120x120 6mm
A0CU Boost Pro Tobacco 120x120 6mm

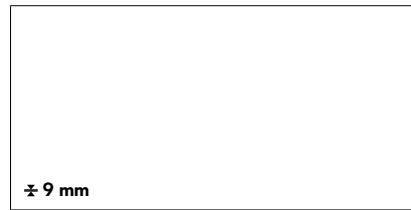

120x240 cm 47 1/4"x94 1/2"
A0CF Boost Pro Ivory 120x240
A0CG Boost Pro Cream 120x240
A0CJ Boost Pro Clay 120x240
A0CH Boost Pro Taupe 120x240
A0CI Boost Pro Tobacco 120x240

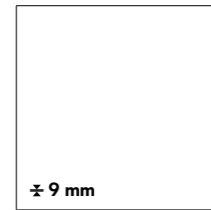

120x120 cm 47 1/4"x47 1/4"
A0AF Boost Pro Ivory 120x120
A0AH Boost Pro Cream 120x120
A0AJ Boost Pro Clay 120x120
A0AL Boost Pro Taupe 120x120
A0AN Boost Pro Tobacco 120x120



60x120 cm 23 5/8"x47 1/4"
A0BY Boost Pro Ivory 60x120
A0BZ Boost Pro Cream 60x120
A0B0 Boost Pro Clay 60x120
A0B8 Boost Pro Taupe 60x120
A0B9 Boost Pro Tobacco 60x120



75x150 cm 29 1/2"x59"
A21P Boost Pro Ivory 75x150
A28B Boost Pro Cream 75x150
A28C Boost Pro Clay 75x150
A28E Boost Pro Taupe 75x150
A21Q Boost Pro Tobacco 75x150

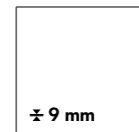

75x75 cm 29 1/2"x29 1/2"
A28F Boost Pro Ivory 75x75
A28G Boost Pro Cream 75x75
A28H Boost Pro Clay 75x75
A28I Boost Pro Taupe 75x75
A28J Boost Pro Tobacco 75x75

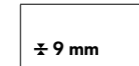

37,5x75 cm 14 3/4"x29 1/2"
A28K Boost Pro Ivory 37,5x75
A28M Boost Pro Cream 37,5x75
A28N Boost Pro Clay 37,5x75
A28O Boost Pro Taupe 37,5x75
A28P Boost Pro Tobacco 37,5x75

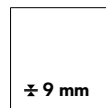

60x60 cm 23 5/8"x23 5/8"
A0C3 Boost Pro Ivory 60x60
A0C4 Boost Pro Cream 60x60
A0C5 Boost Pro Clay 60x60
A0C6 Boost Pro Taupe 60x60
A0C7 Boost Pro Tobacco 60x60

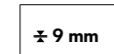

30x60 cm 11 3/4"x23 5/8"
A0C8 Boost Pro Ivory 30x60
A0C9 Boost Pro Cream 30x60
A0DA Boost Pro Clay 30x60
A0DB Boost Pro Taupe 30x60
A0DC Boost Pro Tobacco 30x60



IVORY



CREAM



CLAY



TAUPE



TOBACCO



V3
MODERATE
VARIATION

BOOST PRO Porcelain Tiles / Gres Porcellanato

GRIP SURFACE / SUPERFICIE GRIP

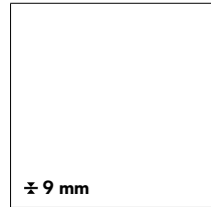

120x120 cm 47¹/₄"x47¹/₄"

- A0AO Boost Pro Ivory 120x120 Grip
- A0AQ Boost Pro Cream 120x120 Grip
- A0BV Boost Pro Clay 120x120 Grip
- A0BW Boost Pro Taupe 120x120 Grip
- A0BX Boost Pro Tobacco 120x120 Grip

GRIP



IVORY



CREAM



CLAY



TAUPE



TOBACCO

OUTDOOR PAVING ± 20 mm / PAVIMENTI DA ESTERNO ± 20 mm

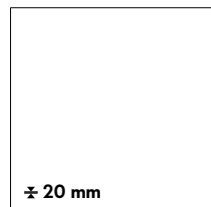

120x120 cm 47¹/₄"x47¹/₄"

- A3DD Boost Pro Cream 120x120 20 mm
- A3DE Boost Pro Clay 120x120 20 mm
- A3DF Boost Pro Taupe 120x120 20 mm
- A3DH Boost Pro Tobacco 120x120 20 mm



60x120 cm 23⁵/₈"x47¹/₄"

- A4XU Boost Pro Cream 60x120 20 mm
- A4XV Boost Pro Clay 60x120 20 mm
- A4XW Boost Pro Taupe 60x120 20 mm
- A4XX Boost Pro Tobacco 60x120 20 mm

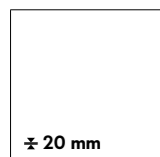

90x90 cm 35⁵/₈"x35⁵/₈"

- A4XM Boost Pro Cream 90x90 20 mm
- A4XN Boost Pro Clay 90x90 20 mm
- A4XO Boost Pro Taupe 90x90 20 mm
- A4XP Boost Pro Tobacco 90x90 20 mm

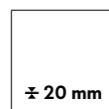

60x60 cm 23⁵/₈"x23⁵/₈"

- A4XQ Boost Pro Cream 60x60 20 mm
- A4XR Boost Pro Clay 60x60 20 mm
- A4XS Boost Pro Taupe 60x60 20 mm
- A4XT Boost Pro Tobacco 60x60 20 mm

OUTDOOR PAVING ± 20 mm



CREAM

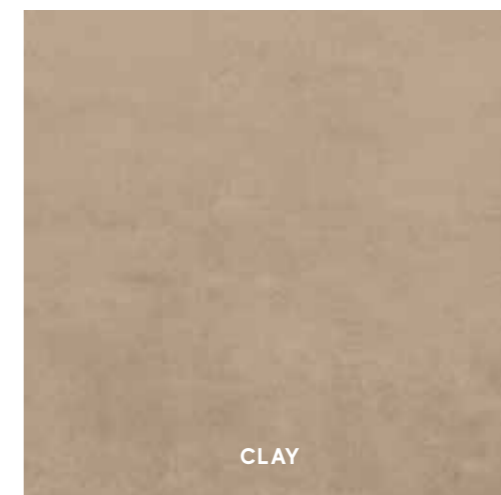

CLAY

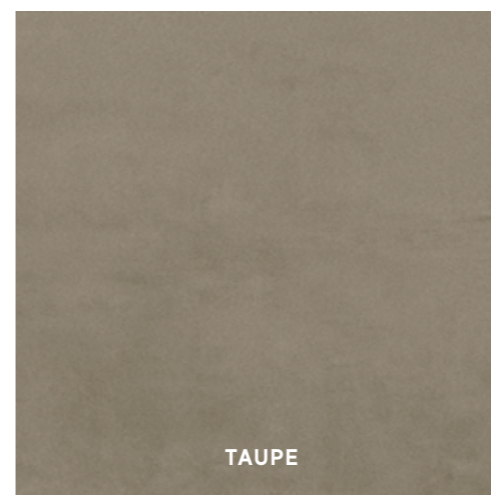

TAUPE

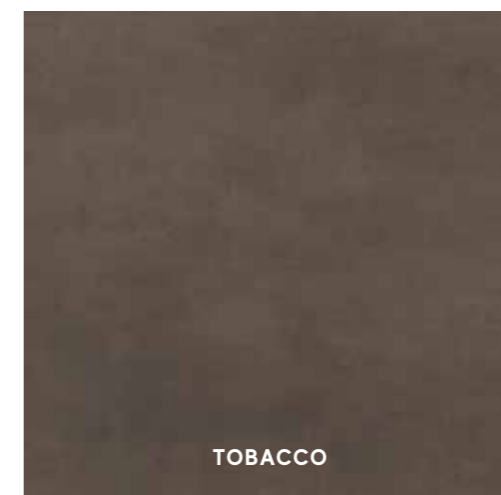

TOBACCO



V3
MODERATE
VARIATION

GRIP SURFACE | SUPERFICIE GRIP | Surface grip | Grip oberfläche | Superficie Grip | Grip поверхность
OUTDOOR PAVING | PAVIMENTI DA ESTERNO | Sols d'extérieur | Außenbereiche | Pavimentos para exteriores | Уличная плитка

BOOST PRO Porcelain Tiles / Gres Porcellanato

DECOR RANGE / GAMMA DECORI



AØLX Boost Pro Paint 120x278 ••
120x278 - 47 1/4" x 109 1/2"



A3HE Boost Pro Leaves A 120x278 •
A3M2 Boost Pro Leaves B 120x278
120x278 - 47 1/4" x 109 1/2"



AØLW Boost Pro Grove 120x278 ••
120x278 - 47 1/4" x 109 1/2"



Module Assembly

- **THE USE OF A COMMON MILD DETERGENT IS RECOMMENDED. AVOID USING ACIDIC OR ALKALINE PRODUCTS, WAXES, STEEL WOOL, OR ABRASIVES.**
 SI CONSIGLIA L'UTILIZZO DI UN COMUNE DETERGENTE NEUTRO. EVITARE L'UTILIZZO DI PRODOTTI ACIDI O ALCALINI, CERANTI, PAGLIETTE DI METALLO O ABRASIVE.
 Nous vous conseillons d'utiliser des détergents neutres courants. Éviter l'utilisation de cires et de produits acides ou alcalins, ainsi que les pailles métalliques ou abrasives.
 Es empfiehlt sich, ein haushaltsübliches, neutrales Reinigungsmittel zu verwenden. Saure oder alkalische Produkte, Wachs sowie Metallwolle- bzw. Scheuerschwämme sind zu vermeiden.
 Recomendamos utilizar un detergente neutro común. Hay que evitar el uso de productos ácidos o alcalinos, ceras y estropajos de metal o abrasivos.
 Рекомендуется чистить обычным нейтральным моющим средством. Не рекомендуется использовать кислотные, щелочные, восковые средства, а также металлические мочалки.
- **THE PRODUCTION PROCESS DOES NOT GUARANTEE THE PRESENCE OF THE EXACT SEQUENCE OF THE GRAPHICS INSIDE THE PACKAGING.**
 IL PROCESSO PRODUTTIVO NON GARANTISCE LA PRESENZA DELL'ESATTA SEQUENZA DELLE GRAFICHE ALL'INTERNO DELL'IMBALLLO.
 Le processus de fabrication ne garantit pas la présence de la séquence exacte des graphismes l'intérieur de l'emballage.
 Der Produktionsprozess garantiert nicht die exakte Sequenz der Grafiken in der Verpackung.
 El proceso de producción no garantiza la presencia de la secuencia exacta de los gráficos dentro del embalaje.
 Процесс производства не обеспечивает наличие точно совпадающих рисунков поверхности внутри упаковки.

☞ **THE DECORATION CAN ONLY BE LAID ON THE WALL | IL DECORO SI PUÒ POSARE SOLO A RIVESTIMENTO**
 Decor uniquement mural | Das Dekor kann nur an der Wand verlegt werden | La decoración se puede colocar únicamente en paredes | Декор может быть уложен только на стену.

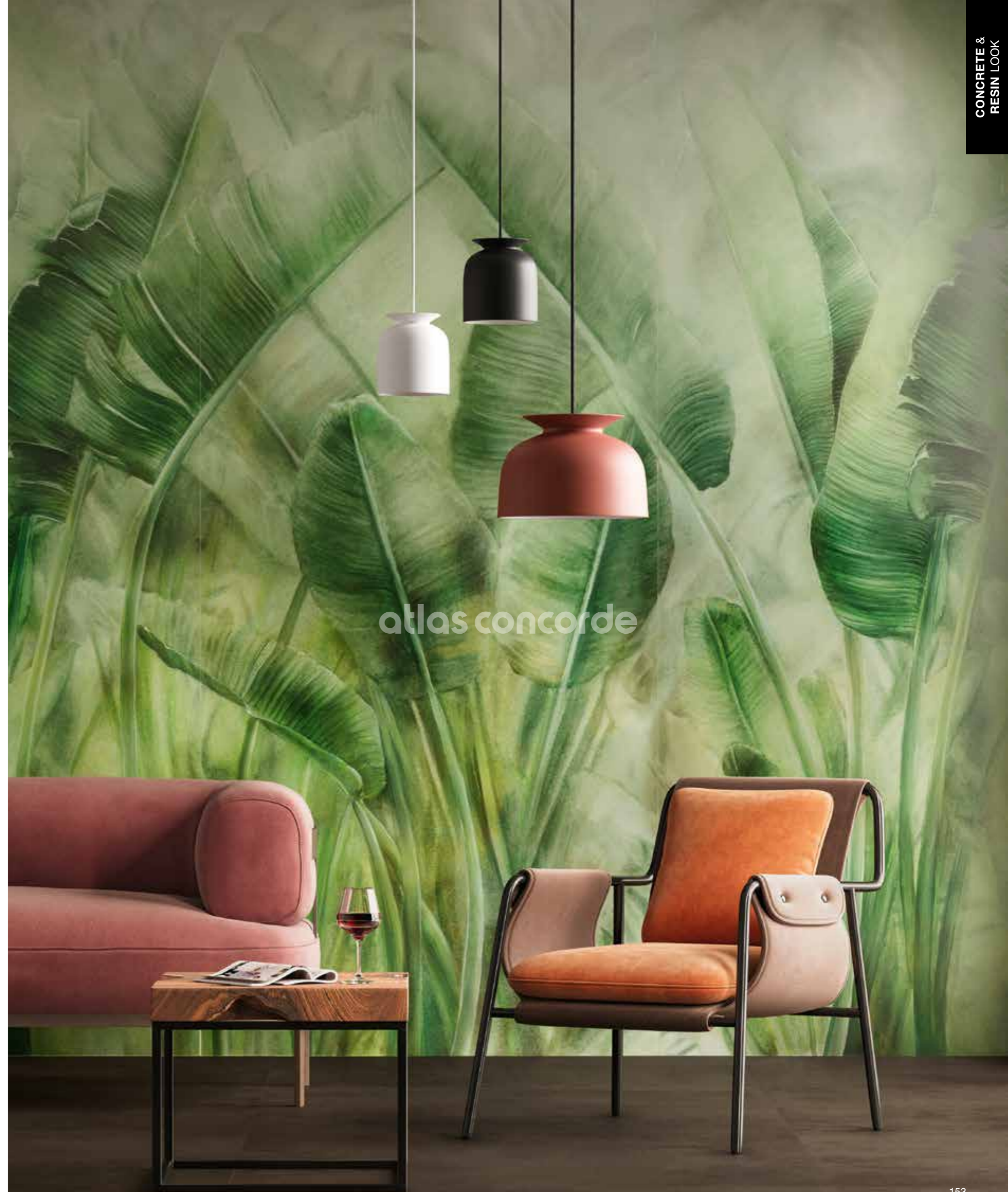

BOOST PRO Porcelain Tiles / Gres Porcellanato

DECOR RANGE / GAMMA DECORI

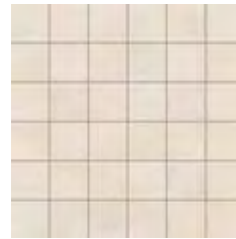

A0QQ Boost Pro Ivory Mosaico Matt
30x30 - 11³/₄"x11³/₄"

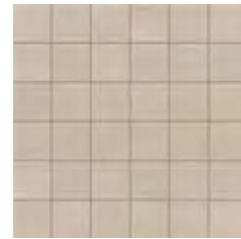

A0QR Boost Pro Cream Mosaico Matt
30x30 - 11³/₄"x11³/₄"



A0QS Boost Pro Clay Mosaico Matt
30x30 - 11³/₄"x11³/₄"



A0QT Boost Pro Taupe Mosaico Matt
30x30 - 11³/₄"x11³/₄"



A0QU Boost Pro Tobacco Mosaico Matt
30x30 - 11³/₄"x11³/₄"

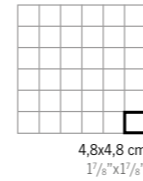

A0P8 Boost Pro Ivory Mosaico Shapes
31x33,5 - 12¹/₄"x13³/₄"



A0P9 Boost Pro Cream Mosaico Shapes
31x33,5 - 12¹/₄"x13³/₄"



A0QB Boost Pro Clay Mosaico Shapes
31x33,5 - 12¹/₄"x13³/₄"

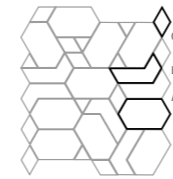

A0QC Boost Pro Taupe Mosaico Shapes
31x33,5 - 12¹/₄"x13³/₄"



A0QD Boost Pro Tobacco Mosaico Shapes
31x33,5 - 12¹/₄"x13³/₄"



A0QN Boost Pro Ivory Mosaico Hex Olive
25x28,5 - 9⁷/₈"x11¹/₄"



A0QO Boost Pro Cream Mosaico Hex Blue
25x28,5 - 9⁷/₈"x11¹/₄"



A0QP Boost Pro Taupe Mosaico Hex Coffee
25x28,5 - 9⁷/₈"x11¹/₄"

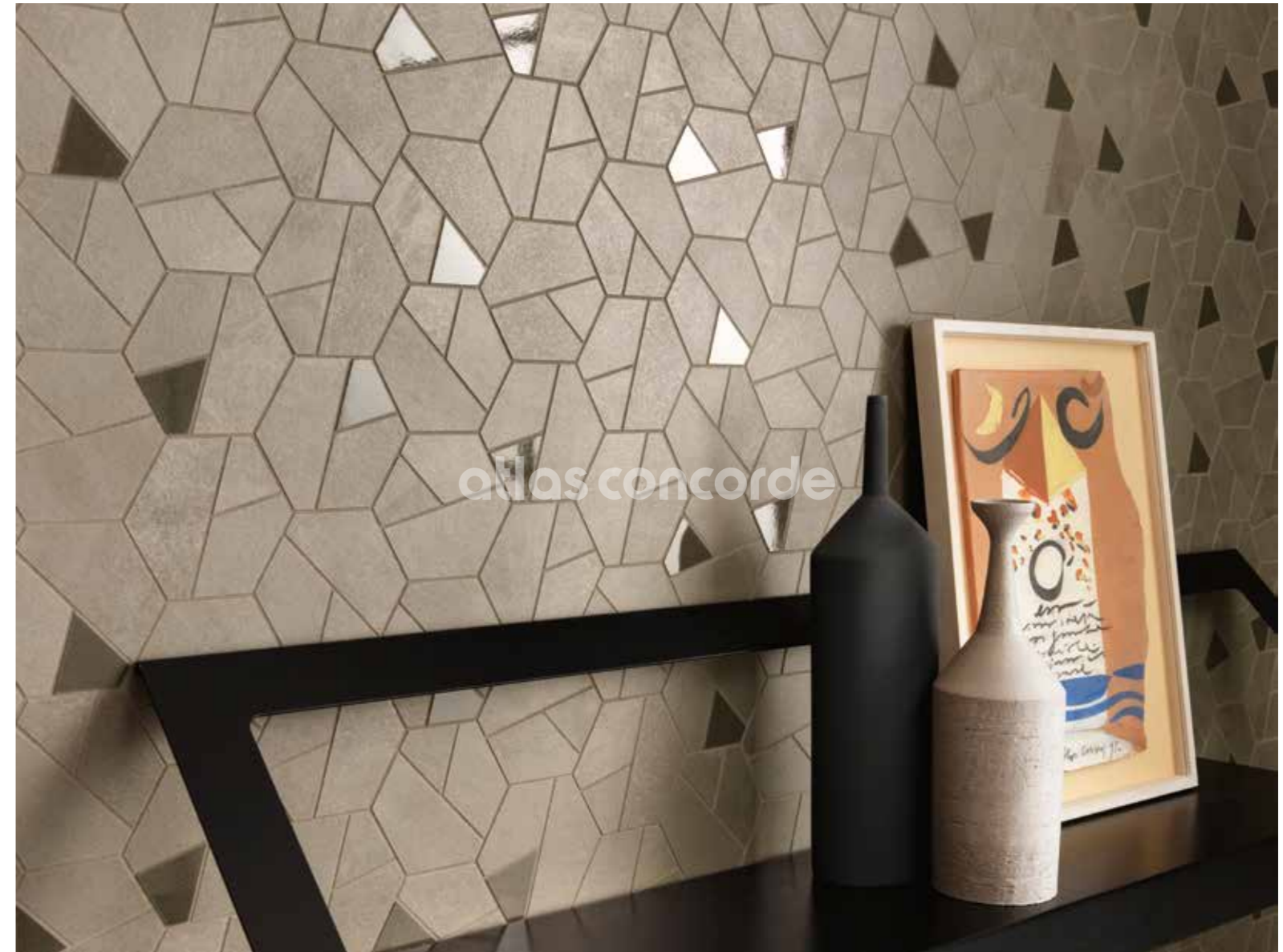

TRIM TILES / PEZZI SPECIALI

p. 568

UPEC p. 595

	Battiscopa 7,2x60 2 ⁷ / ₈ "x23 ⁵ / ₈ "	Battiscopa Digitale 4,6x60 1 ³ / ₄ "x23 ⁵ / ₈ "	Gradino * 30x60 11 ³ / ₄ "x23 ⁵ / ₈ "	Scalino * 33x150 13"x59"	Scalino * 33x120 13"x47 ¹ / ₄ "	Scalino * 33x60 13"x23 ⁵ / ₈ "	Scalino Angolare * 33x33 13"x13"	Battiscopa Sag. Scala 7,2x30 - 2 ⁷ / ₈ "x11 ³ / ₄ "		Elemento L Grip 33x120 H.4 cm 13"x47 ¹ / ₄ " H.1 ⁵ / ₈ "
								DX *	SX *	
Ivory	A0QI	A0QV	A280	A3CY	A3CT	A3CO	A3C3	A0Q0	A0RX	A3C8
Cream	A0QJ	A0QW	A283	A3CZ	A3CU	A3CP	A3C4	A0Q8	A0RY	A3C9
Clay	A0QK	A0QX	A284	A3C0	A3CV	A3CQ	A3C5	A0Q9	A0WQ	A3DA
Taupe	A0QL	A0QY	A285	A3C1	A3CW	A3CR	A3C6	A0RA	A04M	A3DB
Tobacco	A0QM	A0QZ	A289	A3C2	A3CX	A3CS	A3C7	A0RM	A28Z	A3DC

* THESE PARTS ARE SUPPLIED TO ORDER . I PEZZI SONO DISPONIBILI SU ORDINAZIONE I Les pièces sont disponibles sur commande I Die Teile sind auf Bestellung lieferbar I Las piezas se hacen por encargo I Изготавливаются на заказ



BOOST PRO

WALL TILES



Wall Tiles / Rivestimento

WHITEBODY WALL TILES - RECTIFIED MONOCALIBER
RIVESTIMENTI IN PASTA BIANCA - RETTIFICATO MONOCALIBRO

Sizes	Thickness	Surface finish
40x80 cm - 15 ³ / ₄ "x31 ¹ / ₂ "	± 8,5 mm	Matte

3D Wall Tiles

Sizes	Thickness	Surface finish
40x80 cm - 15 ³ / ₄ "x31 ¹ / ₂ "	± 10 mm	Matte

DECORATIVE RANGE / GAMMA DECORATIVA



MINIBRICK



WHITEBODY WALL TILES | RIVESTIMENTI IN PASTA BIANCA | Revêtements en pâte blanche | Weißscherbige Wandfliesen | Revestimientos en pasta blanca | Настенная плитка из белой глины
RECTIFIED MONOCALIBER | RETTIFICATO MONOCALIBRO | Rectifié mono-calibre | Geschliffen einkalibrig | Rectificado monocalibré | Ретицированный в одном калибре

BOOST PRO Wall Tiles / Rivestimento

MATTE SURFACE / SUPERFICIE MATT



8B8I Boost Pro Ivory 40x80
40x80 - 15³/₄"x31¹/₂"



8B8E Boost Pro Cream 40x80
40x80 - 15³/₄"x31¹/₂"



8B8C Boost Pro Clay 40x80
40x80 - 15³/₄"x31¹/₂"



8B8M Boost Pro Mustard 40x80
40x80 - 15³/₄"x31¹/₂"

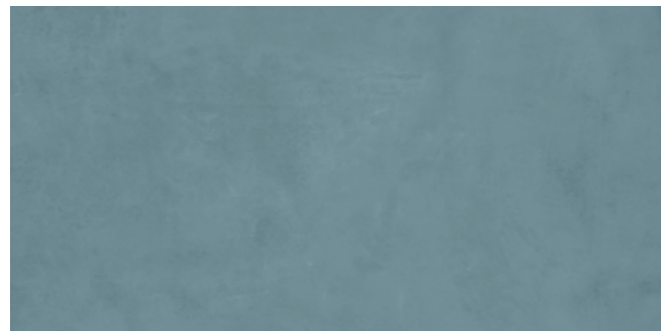

8B8B Boost Pro Powder Blue 40x80
40x80 - 15³/₄"x31¹/₂"

TRIM TILES / PEZZI SPECIALI

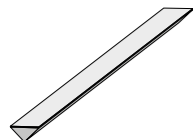

- 1,4x40 cm - 5⁵/₈"x15³/₄"
- LBBI Boost Pro Ivory Corner 40 •
 - LBBM Boost Pro Cream Corner 40 •
 - LBBA Boost Pro Clay Corner 40 •
 - LBBU Boost Pro Mustard Corner 40 •
 - LBBG Boost Pro Powder Blue Corner 40 •



- 1,4x1,4 cm - 5⁵/₈"x5⁵/₈"
- AQAI Boost Pro Ivory Corner A.E. •
 - AQAE Boost Pro Cream Corner A.E. •
 - AQAC Boost Pro Clay Corner A.E. •
 - AQAM Boost Pro Mustard Corner A.E. •
 - AQAB Boost Pro Powder Blue Corner A.E. •

3D TRIM TILES / PEZZI SPECIALI 3D

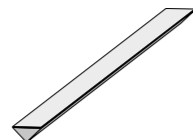

- 1,4x40 cm - 5⁵/₈"x15³/₄"
- LB3I Boost Pro Ivory 3D Corner 40 •
 - LB3C Boost Pro Clay 3D Corner 40 •
 - LB3B Boost Pro Powder Blue 3D Corner 40 •



BOOST PRO 3D Wall Tiles / Rivestimento 3D

MATTE SURFACE / SUPERFICIE MATT



8BUI Boost Pro 3D Urban Ivory 40x80
40x80 - 15³/₄"x31¹/₂"



8BUC Boost Pro 3D Urban Clay 40x80
40x80 - 15³/₄"x31¹/₂"

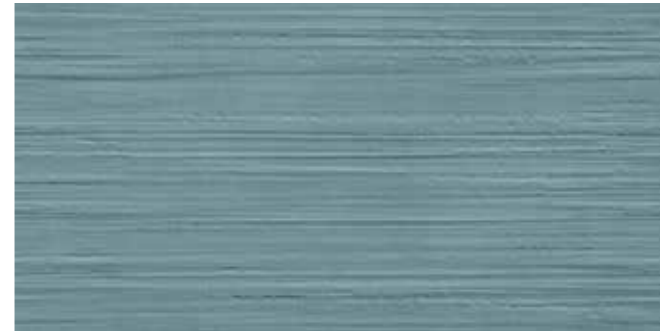

8BUB Boost Pro 3D Urban Powder Blue 40x80
40x80 - 15³/₄"x31¹/₂"

DECOR RANGE / GAMMA DECORI



9BMI Boost Pro Ivory
Minibrick Pro Olive
29,7x33,3 - 11⁵/₈"x13³/₄"



9BMV Boost Pro Cream
Minibrick Pro Blue
29,7x33,3 - 11⁵/₈"x13³/₄"



9BMZ Boost Pro Clay
Minibrick Pro Coffee
29,7x33,3 - 11⁵/₈"x13³/₄"



9BMT Boost Pro Mustard
Minibrick Pro Yellow
29,7x33,3 - 11⁵/₈"x13³/₄"



9BMU Boost Pro Powder Blue
Minibrick Pro Ocean
29,7x33,3 - 11⁵/₈"x13³/₄"

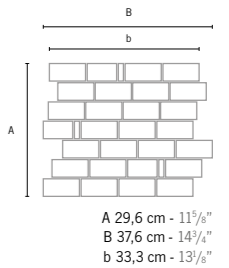

V2
SLIGHT
VARIATION

MATTE SURFACE | SUPERFICIE MATT | Surface Mat | Matt oberfläche | Superficie Mate | Матовая поверхность



V2
SLIGHT
VARIATION

159



atlas concorde

dwell
PORCELAIN & WALL TILES

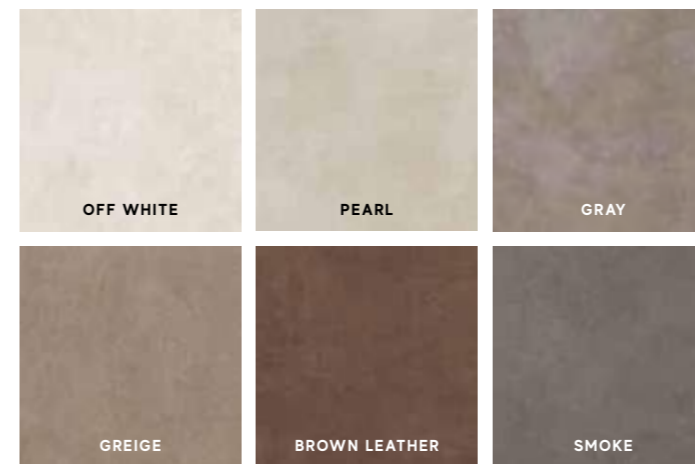

Porcelain Tiles / Gres Porcellanato

COLOURED BODY PORCELAIN TILES - RECTIFIED MONOCALIBER
GRES PORCELLANATO COLORATO IN MASSA - RETTIFICATO MONOCALIBRO

LARGE SIZES p. 500

Sizes	Thickness	Surface finish
120x120 cm - 47 ¹ / ₄ "x47 ¹ / ₄ "	± 9 mm	Matte R9 A
75x150 cm - 29 ¹ / ₂ "x59"	± 9 mm	Polished Matte R9 A
75x75 cm - 29 ¹ / ₂ "x29 ¹ / ₂ "	± 9 mm	Polished Matte R9 A
60x60 cm - 23 ⁵ / ₈ "x23 ⁵ / ₈ "	± 9 mm	Polished Matte R9 A
30x60 cm - 11 ³ / ₄ "x23 ⁵ / ₈ "	± 9 mm	Polished Matte R9 A

Outdoor Paving and Wet Areas

OUTDOOR PAVING p. 554

Sizes	Thickness	Surface finish
90x90 cm - 35 ³ / ₈ "x35 ³ / ₈ "	± 20 mm	Textured R11 A+B+C

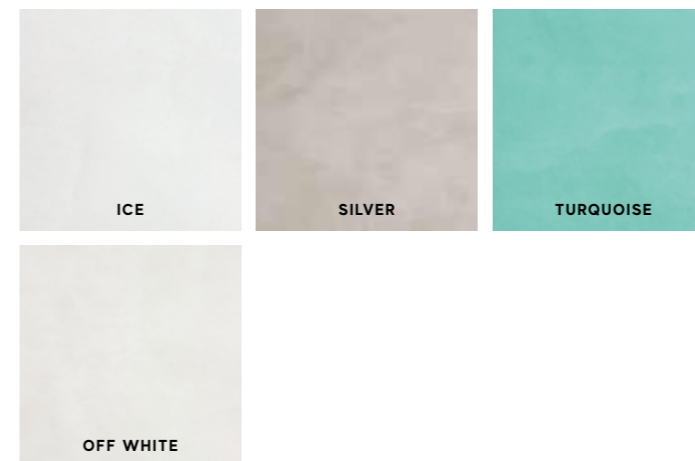

Wall Tiles / Rivestimento

WHITEBODY WALL TILES - RECTIFIED MONOCALIBER
RIVESTIMENTI IN PASTA BIANCA - RETTIFICATO MONOCALIBRO

Sizes	Thickness	Surface finish
40x80 cm - 15 ³ / ₄ "x31 ¹ / ₂ "	± 8,5 mm	Shiny

DWELL Porcelain Tiles / Gres Porcellanato

MATTE SURFACE / SUPERFICIE MATT

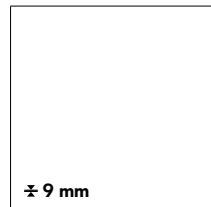
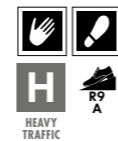

120x120 cm 47¹/₄"x47¹/₄"

- A1QJ Dwell Off White 120x120
- A1QK Dwell Gray 120x120
- A1QL Dwell Greige 120x120
- A1QM Dwell Smoke 120x120



75x150 cm 29¹/₂"x59"

- AW7V Dwell Off White 75x150
- AW7W Dwell Pearl 75x150
- AW7X Dwell Gray 75x150
- AW7Y Dwell Greige 75x150
- AW7Z Dwell Brown Leather 75x150
- AW7Ø Dwell Smoke 75x150

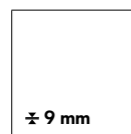

75x75 cm 29¹/₂"x29¹/₂"

- AW78 Dwell Off White 75x75
- AW8A Dwell Pearl 75x75
- AW8B Dwell Gray 75x75
- AW8C Dwell Greige 75x75
- AW8D Dwell Brown Leather 75x75
- AW8E Dwell Smoke 75x75

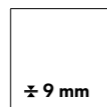

60x60 cm 23⁵/₈"x23⁵/₈"

- AW8Y Dwell Off White 60x60
- AW8Z Dwell Pearl 60x60
- AW8Ø Dwell Gray 60x60
- AW81 Dwell Greige 60x60
- AW82 Dwell Brown Leather 60x60
- AW83 Dwell Smoke 60x60

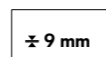

30x60 cm 11³/₄"x23⁵/₈"

- DØ61 Dwell Off White 30x60
- DØ62 Dwell Pearl 30x60
- DØ63 Dwell Gray 30x60
- DØ64 Dwell Greige 30x60
- DØ65 Dwell Brown Leather 30x60
- DØ66 Dwell Smoke 30x60

OUTDOOR PAVING ± 20 mm / PAVIMENTI DA ESTERNO ± 20 mm

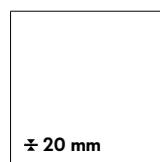

90x90 cm 35³/₈"x35³/₈"

- AL78 Dwell Off White 90x90 Lastra 20 mm
- AL79 Dwell Pearl 90x90 Lastra 20 mm
- AL8A Dwell Gray 90x90 Lastra 20 mm
- AL8B Dwell Smoke 90x90 Lastra 20 mm

MATTE



OFF WHITE



PEARL



GREIGE



BROWN LEATHER

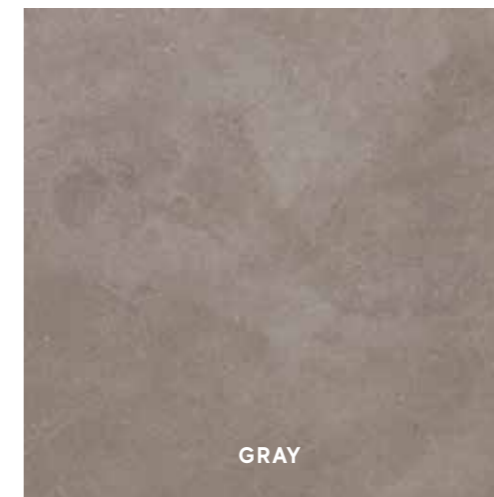

GRAY



SMOKE

OUTDOOR PAVING ± 20 mm



OFF WHITE



PEARL



GRAY



SMOKE



V2
SLIGHT
VARIATION

DWELL Porcelain Tiles / Gres Porcellanato

POLISHED SURFACE / SUPERFICIE LAPPATA

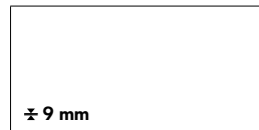

75x150 cm 29 1/2" x 59"

- AW7P Dwell Off White 75x150 Lappato
- AW7Q Dwell Pearl 75x150 Lappato
- AW7R Dwell Gray 75x150 Lappato
- AW7S Dwell Greige 75x150 Lappato
- AW7T Dwell Brown Leather 75x150 Lappato
- AW7U Dwell Smoke 75x150 Lappato

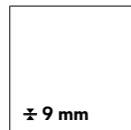

75x75 cm 29 1/2" x 29 1/2"

- AW71 Dwell Off White 75x75 Lappato
- AW72 Dwell Pearl 75x75 Lappato
- AW73 Dwell Gray 75x75 Lappato
- AW74 Dwell Greige 75x75 Lappato
- AW75 Dwell Brown Leather 75x75 Lappato
- AW77 Dwell Smoke 75x75 Lappato

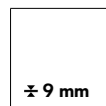

60x60 cm 23 3/8" x 23 3/8"

- AW9C Dwell Off White 60x60 Lappato
- AW9D Dwell Pearl 60x60 Lappato
- AW9E Dwell Gray 60x60 Lappato
- AW9F Dwell Greige 60x60 Lappato
- AW9G Dwell Brown Leather 60x60 Lappato
- AW9H Dwell Smoke 60x60 Lappato

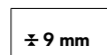

30x60 cm 11 1/4" x 23 3/8"

- D001 Dwell Off White 30x60 Lappato
- D002 Dwell Pearl 30x60 Lappato
- D003 Dwell Gray 30x60 Lappato
- D004 Dwell Greige 30x60 Lappato
- D005 Dwell Brown Leather 30x60 Lappato
- D006 Dwell Smoke 30x60 Lappato



The glossy polished finish is suitable for residential or low-traffic commercial floors, where no anti-slip performance is required, and for walls. The glossy polished surface finish, surprisingly brilliant and bright, features slight irregularities. The extraordinary brilliance and the easy cleaning of the surface are the result of in-depth research aimed at guaranteeing its durability over time. If the product is in direct contact with the outdoors, provide devices for absorbing moisture and dirt to prevent scratches. / La finitura Lappata lucida è indicata per pavimenti residenziali o commerciali poco sollecitati, laddove non siano richieste prestazioni antiscivolo, e per rivestimenti. La finitura lappata lucida offre una superficie sorprendentemente brillante e specchiante, con lievi irregolarità. La straordinaria lucentezza e l'elevata pulibilità della superficie sono frutto di studi approfonditi e accurate ricerche tecniche volte a garantirne la persistenza nel tempo. Se il prodotto è a diretto contatto con l'esterno, prevedere dei dispositivi di assorbimento dell'umidità e della sporcizia per prevenire la formazione di graffi.

If the product is in direct contact with the outdoors, provide devices for absorbing moisture and dirt to prevent scratches. / Se il prodotto è a diretto contatto con l'esterno, prevedere dei dispositivi di assorbimento dell'umidità e della sporcizia per prevenire la formazione di graffi.

POLISHED SURFACE | SUPERFICIE LAPPATA | Surface adouci | Geläpopt oberfläche | Superficie brufido | Полуполированный поверхность



V2
SLIGHT
VARIATION



OFF WHITE



GREIGE



PEARL



BROWN LEATHER



GRAY



SMOKE

DWELL Porcelain Tiles / Gres Porcellanato

DECOR RANGE / GAMMA DECORI

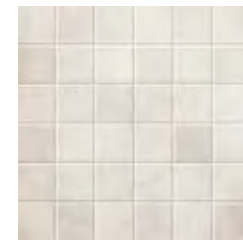

A1CX Dwell Off White Mosaico
30x30 - 11³/₄"x11³/₄"

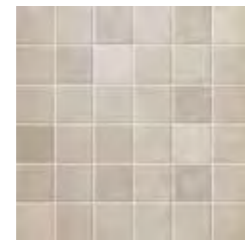

A1CY Dwell Pearl Mosaico
30x30 - 11³/₄"x11³/₄"

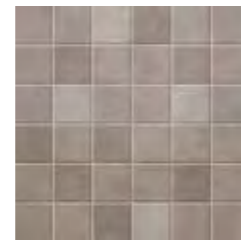

A1CZ Dwell Gray Mosaico
30x30 - 11³/₄"x11³/₄"

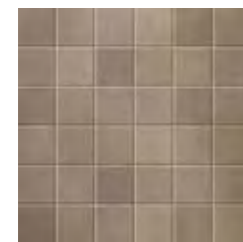
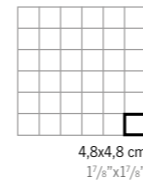

A1C0 Dwell Greige Mosaico
30x30 - 11³/₄"x11³/₄"

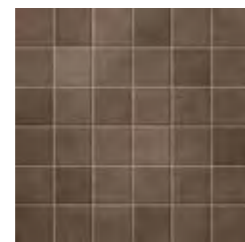

A1C1 Dwell Brown Leather Mosaico
30x30 - 11³/₄"x11³/₄"

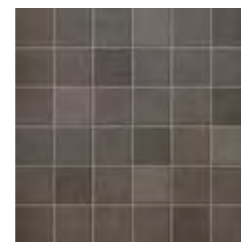

A1C2 Dwell Smoke Mosaico
30x30 - 11³/₄"x11³/₄"



A1C9 Dwell Off White Herringbone
36,2x41,2 - 14¹/₈"x16¹/₈"



A1DA Dwell Pearl Herringbone
36,2x41,2 - 14¹/₈"x16¹/₈"



A1DC Dwell Gray Herringbone
36,2x41,2 - 14¹/₈"x16¹/₈"

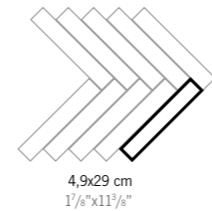

A1DD Dwell Greige Herringbone
36,2x41,2 - 14¹/₈"x16¹/₈"



A1DE Dwell Brown Leather Herringbone
36,2x41,2 - 14¹/₈"x16¹/₈"



A1DF Dwell Smoke Herringbone
36,2x41,2 - 14¹/₈"x16¹/₈"



A1YA Dwell Off White Listello
8x60 - 3¹/₈"x23³/₈"



A1YB Dwell Pearl Listello
8x60 - 3¹/₈"x23³/₈"



A1X8 Dwell Gray Listello
8x60 - 3¹/₈"x23³/₈"



A1X9 Dwell Greige Listello
8x60 - 3¹/₈"x23³/₈"



A1X7 Dwell Brown Leather Listello
8x60 - 3¹/₈"x23³/₈"



A1YC Dwell Smoke Listello
8x60 - 3¹/₈"x23³/₈"



A1DQ Dwell Off White Brick Lappato
21,7x43,6 - 8¹/₂"x17¹/₈"



A1E3 Dwell Pearl Brick Lappato
21,7x43,6 - 8¹/₂"x17¹/₈"

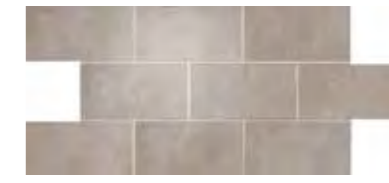

A1E4 Dwell Gray Brick Lappato
21,7x43,6 - 8¹/₂"x17¹/₈"

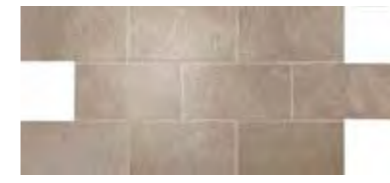
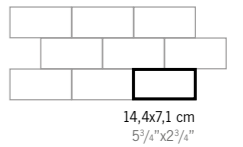

A1E5 Dwell Greige Brick Lappato
21,7x43,6 - 8¹/₂"x17¹/₈"

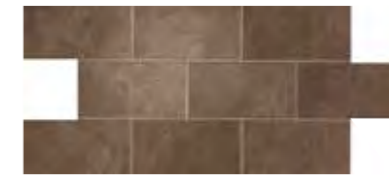

A1E6 Dwell Brown Leather Brick Lappato
21,7x43,6 - 8¹/₂"x17¹/₈"

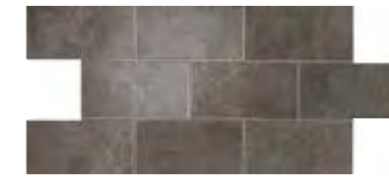

A1E7 Dwell Smoke Brick Lappato
21,7x43,6 - 8¹/₂"x17¹/₈"



A1DK Dwell Off White Chevron 3D *
30,8x35,1 - 12"x13³/₄"



A1DL Dwell Pearl Chevron 3D *
30,8x35,1 - 12"x13³/₄"



A1DM Dwell Gray Chevron 3D *
30,8x35,1 - 12"x13³/₄"

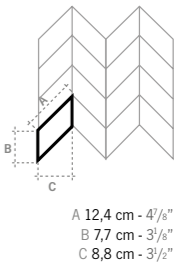

A1DN Dwell Greige Chevron 3D *
30,8x35,1 - 12"x13³/₄"



A1DO Dwell Brown Leather Chevron 3D *
30,8x35,1 - 12"x13³/₄"



A1DP Dwell Smoke Chevron 3D *
30,8x35,1 - 12"x13³/₄"

• **MULTI-THICKNESS MOSAIC, CLOSE JOINT INSTALLATION WITHOUT GROUTING.**
MOSAICO MULTISPESORE, POSA SENZA STUCCATURA A GIUNTO UNITO.
 Mosaïque multi-épaisseur, pose sans mastic avec joint nul.
 Mosaik mit verschiedenen Stärken, fugenlose Verlegung ohne Mörtel.
 Mosaico multispesor, colocación sin mástico y sin juntas.
 Мозаика разной толщины; укладка встык без затирки швов.

TRIM TILES / PEZZI SPECIALI

p. 568

UPEC p. 595

	Battiscopa		Gradino *	Scalino *	Scalino *	Scalino *	Scalino Angolare	Battiscopa Sag. Scala		
	7,2x60 2 ⁷ / ₈ "x23 ⁵ / ₈ "	Battiscopa Lappato 7,2x60 2 ⁷ / ₈ "x23 ⁵ / ₈ "	30x60 11 ³ / ₄ "x23 ⁵ / ₈ "	33x150 13"x59"	33x75 13"x29 ¹ / ₂ "	33x60 13"x23 ⁵ / ₈ "	33x33 - 13"x13"	DX *	SX *	DX *
Off White	A1E8	A1FG	A1KE	AZUC	A1KQ	A1KW	A1K8	A1K2	A1LK	A1LE
Pearl	A1E9	A1FH	A1KF	AZFF	A1KR	A1KX	A1K9	A1K3	A1LL	A1LF
Gray	A1FC	A1FI	A1KG	AZUD	A1KS	A1KY	A1LA	A1K4	A1LM	A1LG
Greige	A1FD	A1FJ	A1KH	AZUE	A1KT	A1KZ	A1LB	A1K5	A1LN	A1LH
Brown Leather	A1FE	A1FK	A1KI	AZUF	A1KU	A1K0	A1LC	A1K6	A1LO	A1LI
Smoke	A1FF	A1FL	A1KJ	AZUG	A1KV	A1K1	A1LD	A1K7	A1LP	A1LJ

* THESE PARTS ARE SUPPLIED TO ORDER | I PEZZI SONO DISPONIBILI SU ORDINAZIONE | Les pièces sont disponibles sur commande | Die Teile sind auf Bestellung lieferbar | Las piezas se hacen por encargo | Изготавливаются на заказ

THE DECORATION CAN ONLY BE LAID ON THE WALL | IL DECORO SI PUÒ POSARE SOLO A RIVESTIMENTO
 Décor uniquement mural | Das Dekor kann nur an der Wand verlegt werden | La decoración se puede colocar únicamente en paredes | Декор может быть уложен только на стену.



atlas concorde

dwell
WALL TILES



Wall Tiles / Rivestimento

WHITEBODY WALL TILES - RECTIFIED MONOCALIBER
RIVESTIMENTI IN PASTA BIANCA - RETTIFICATO MONOCALIBRO

Sizes	Thickness	Surface finish
40x80 cm - 15 ³ / ₄ "x31 ¹ / ₂ "	± 8,5 mm	Shiny

DECORATIVE RANGE / GAMMA DECORATIVA



WHITEBODY WALL TILES | RIVESTIMENTI IN PASTA BIANCA | Revêtements en pâte blanche | Weißscherbige Wandfliesen | Revestimientos en pasta blanca | Настенная плитка из белой глины
RECTIFIED MONOCALIBER | RETTIFICATO MONOCALIBRO | Rectifié mono-calibre | Geschliffen einkalibrig | Rectificado monocalibril | Ретифицированный в одном калибре

DWELL Wall Tiles / Rivestimento

SHINY SURFACE / SUPERFICIE LUCIDA

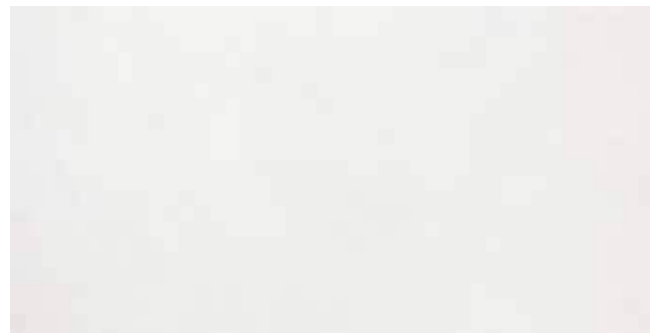

8DWH Dwell Off White 40x80
40x80 cm - 15³/₄"x31¹/₂"

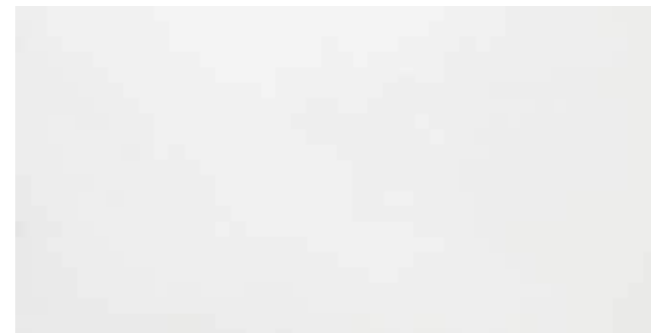

8DWC Dwell Ice 40x80
40x80 cm - 15³/₄"x31¹/₂"



8DWL Dwell Silver 40x80
40x80 cm - 15³/₄"x31¹/₂"



8DWQ Dwell Turquoise 40x80
40x80 cm - 15³/₄"x31¹/₂"

TRIM TILES / PEZZI SPECIALI

- | | |
|---|---|
| LDPI Dwell Ice Spigolo
0,8x20 cm - 3 ¹ / ₈ "x7 ⁷ / ₈ " | A1DI Dwell Ice Spigolo A.E.
0,8x0,8 cm - 3 ¹ / ₈ "x3 ¹ / ₈ " |
| LDPS Dwell Silver Spigolo
0,8x20 cm - 3 ¹ / ₈ "x7 ⁷ / ₈ " | A1DS Dwell Silver Spigolo A.E.
0,8x0,8 cm - 3 ¹ / ₈ "x3 ¹ / ₈ " |
| LDPT Dwell Turquoise Spigolo
0,8x20 cm - 3 ¹ / ₈ "x7 ⁷ / ₈ " | A1DT Dwell Turquoise Spigolo A.E.
0,8x0,8 cm - 3 ¹ / ₈ "x3 ¹ / ₈ " |
| LDPW Dwell Off White Spigolo
0,8x20 cm - 3 ¹ / ₈ "x7 ⁷ / ₈ " | A1DW Dwell Off White Spigolo A.E.
0,8x0,8 cm - 3 ¹ / ₈ "x3 ¹ / ₈ " |



V2
SLIGHT
VARIATION

DWELL Wall Tiles / Rivestimento

DECOR RANGE / GAMMA DECORI

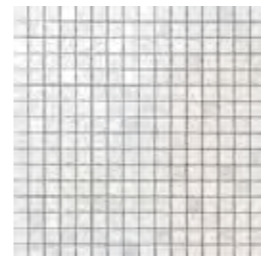

9DQI Dwell Ice Mosaico Q
30,5x30,5 - 12"x12"

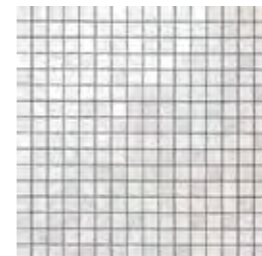

9DQW Dwell Off White Mosaico Q
30,5x30,5 - 12"x12"

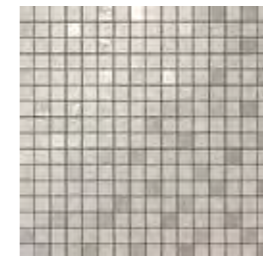

9DQS Dwell Silver Mosaico Q
30,5x30,5 - 12"x12"

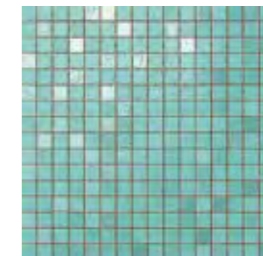

9DQT Dwell Turquoise Mosaico Q
30,5x30,5 - 12"x12"

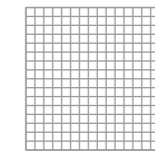

1,7x1,7 cm
5⁵/₈"x5⁵/₈"



9DLI Dwell Ice Mosaico L
30,5x26 - 12"x10¹/₄"



9DLW Dwell Off White Mosaico L
30,5x26 - 12"x10¹/₄"



9DLS Dwell Silver Mosaico L
30,5x26 - 12"x10¹/₄"

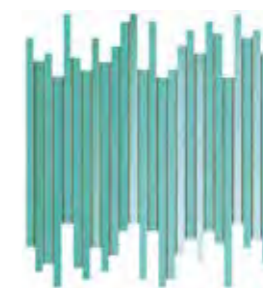

9DLT Dwell Turquoise Mosaico L
30,5x26 - 12"x10¹/₄"



1x26 cm
3³/₈"x10¹/₄"



9DBV Dwell Silver Mosaico Brick
30,5x30,5 - 12"x12"

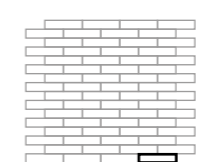

1,7x7,4 cm
5⁵/₈"x2⁷/₈"

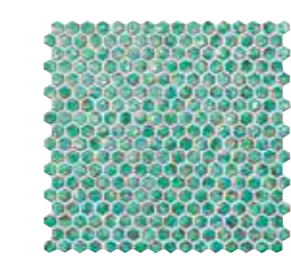

6DHT Dwell Turquoise Hexagon Gold
30x28,5 - 11³/₄"x11¹/₄"

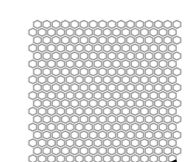

0,9 cm
3³/₈"

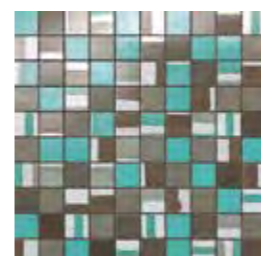

9DMT Dwell Turquoise Mosaico Mix
30,5x30,5 - 12"x12"

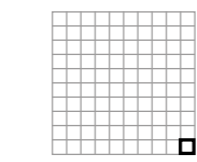

2,8x2,8 cm
1¹/₈"x1¹/₈"



6DMU Dwell Turquoise Mix 4
20x40 - 7⁷/₈"x15³/₄"

■ ENGRAVED MOSAIC WITH PROFILED EDGES.
MOSAICO INCISO CON BORDI SAGOMATI.
Mosaïque gravé avec bords bombés.
Mosaik graviert mit profilierten Kanten.
Mosaico grabado con bordes perfilados.
Высеченная мозаика с фасонными кромками.

• DECOR WITH GOLD INSERT.
DECORO CON INSERTO IN ORO.
Décor avec insert en OR.
Dekor mit Einlage GOLD.
Decoración con aplicación de ORO.
Декор с ЗОЛОТОЙ вставкой.



atlas concorde

eWALL
WALL TILES



Wall Tiles / Rivestimento

COLOURED BODY PORCELAIN TILES - RECTIFIED MONOCALIBER
GRES PORCELLANATO COLORATO IN MASSA - RETTIFICATO MONOCALIBRO

Sizes	Thickness	Surface finish
40x80 cm - 15 ³ / ₄ "x31 ¹ / ₂ "	± 8 mm	Matte

DECORATIVE RANGE / GAMMA DECORATIVA



EWALL Wall Tiles / Rivestimento

MATTE SURFACE / SUPERFICIE MATT

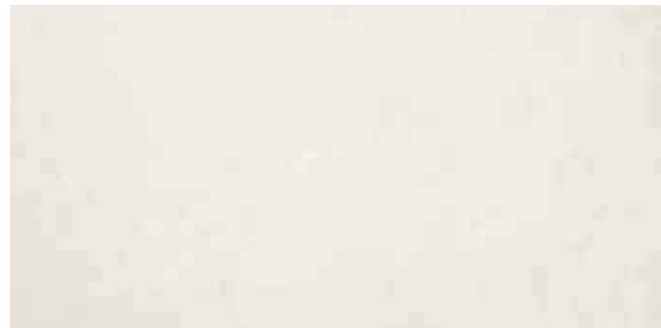

8E4L Ewall Pure 40X80
40x80 - 15³/₄"x31¹/₂"



8E4Z Ewall White 40X80
40x80 - 15³/₄"x31¹/₂"



8E4V Ewall Suede 40X80
40x80 - 15³/₄"x31¹/₂"



8E4D Ewall Concrete 40X80
40x80 - 15³/₄"x31¹/₂"



8E4K Ewall Moka 40X80
40x80 - 15³/₄"x31¹/₂"



8E4H Ewall Night 40X80
40x80 - 15³/₄"x31¹/₂"



8E4B Ewall Amethyst 40X80
40x80 - 15³/₄"x31¹/₂"



8E4G Ewall Orange 40X80
40x80 - 15³/₄"x31¹/₂"



8E4Q Ewall Red 40X80
40x80 - 15³/₄"x31¹/₂"



8E4F Ewall Petroleum Green 40X80
40x80 - 15³/₄"x31¹/₂"

TRIM TILES / PEZZI SPECIALI

LESP Ewall Pure Spigolo 0,8x20 - 3/8"x7 7/8"	AESP Spigolo A.E. 0,8x0,8 - 3/8"x3/8"	LESW Ewall White Spigolo 0,8x20 - 3/8"x7 7/8"	AESW Spigolo A.E. 0,8x0,8 - 3/8"x3/8"
LESS Ewall Suede Spigolo 0,8x20 - 3/8"x7 7/8"	AESD Spigolo A.E. 0,8x0,8 - 3/8"x3/8"	LESC Ewall Concrete Spigolo 0,8x20 - 3/8"x7 7/8"	AESC Spigolo A.E. 0,8x0,8 - 3/8"x3/8"
LESM Ewall Moka Spigolo 0,8x20 - 3/8"x7 7/8"	AESM Spigolo A.E. 0,8x0,8 - 3/8"x3/8"	LESN Ewall Night Spigolo 0,8x20 - 3/8"x7 7/8"	AESN Spigolo A.E. 0,8x0,8 - 3/8"x3/8"

TRIM TILES / PEZZI SPECIALI

LESR Ewall Red Spigolo 0,8x20 - 3/8"x7 7/8"	AESR Spigolo A.E. 0,8x0,8 - 3/8"x3/8"	LESO Ewall Orange Spigolo 0,8x20 - 3/8"x7 7/8"	AESO Spigolo A.E. 0,8x0,8 - 3/8"x3/8"
LESA Ewall Amethyst Spigolo 0,8x20 - 3/8"x7 7/8"	AESA Spigolo A.E. 0,8x0,8 - 3/8"x3/8"	LESE Ewall Petroleum Green Spigolo 0,8x20 - 3/8"x7 7/8"	AESE Spigolo A.E. 0,8x0,8 - 3/8"x3/8"



V2
SLIGHT
VARIATION



V2
SLIGHT
VARIATION

EWALL Wall Tiles / Rivestimento

DECOR RANGE / GAMMA DECORI



9EMI Ewall Pure MiniBrick ✓
30,5x30,5 - 12"x12"



9EMC Ewall Concrete MiniBrick ✓
30,5x30,5 - 12"x12"



9EMN Ewall Night MiniBrick ✓
30,5x30,5 - 12"x12"

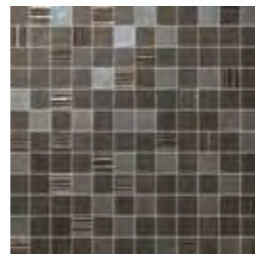

9EMP Ewall Platinum Mosaic • ✓
30,5x30,5 - 12"x12"

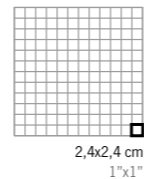

2,4x2,4 cm
1"x1"



9EMW Ewall White MiniBrick ✓
30,5x30,5 - 12"x12"



9EMS Ewall Suede MiniBrick ✓
30,5x30,5 - 12"x12"



9EMM Ewall Moka MiniBrick ✓
30,5x30,5 - 12"x12"

• **DECOR WITH PLATINUM INSERT.**
DECORO CON INSERTO IN PLATINO.
Décor avec insert en PLATINE.
Dekor mit Einlage PLATIN.
Decoración con aplicación de PLATINO.
Декор с ПЛАТИНОВОЙ вставкой

✓ **MATCHING WITH BOTH SIZES 40x80 AND 30.5x56.**
ABBINABILI A ENTRAMBI I FORMATI 40x80 E 30,5x56.
Combinables avec les deux formats 40x80 et 30,5x56.
Kombinierbar mit den beiden Formaten 40x80 und 30,5x56.
Combinables con ambos formatos 40x80 y 30,5x56.
Сочетается с обоими форматами: 40x80 и 30,5x56.



9EMO Ewall Orange MiniBrick ✓
30,5x30,5 - 12"x12"



9EMR Ewall Red MiniBrick ✓
30,5x30,5 - 12"x12"



9EMA Ewall Amethyst MiniBrick ✓
30,5x30,5 - 12"x12"



9EME Ewall Petroleum Green MiniBrick ✓
30,5x30,5 - 12"x12"

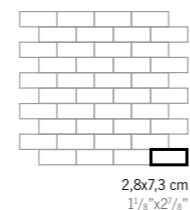

2,8x7,3 cm
1 1/8"x2 7/8"



8EDW Ewall White Gold Damask •
40x80 - 15 3/4"x31 1/2"



8EDH Ewall Petroleum Green Damask
40x80 - 15 3/4"x31 1/2"



8EDK Ewall Moka Gold Damask •
40x80 - 15 3/4"x31 1/2"



8ERW Ewall White Roses
40x80 - 15 3/4"x31 1/2"

• **DECOR WITH GOLD INSERT.** | DECORO CON INSERTO IN ORO. | Décor avec insert en OR. | Dekor mit Einlage GOLD. | Decoración con aplicación de ORO. | Декор с ЗОЛОТОЙ вставкой.



8EEO Ewall Orange Stripes
40x80 - 15 3/4"x31 1/2"



8EEA Ewall Amethyst Stripes
40x80 - 15 3/4"x31 1/2"



8EER Ewall Red Stripes
40x80 - 15 3/4"x31 1/2"



8EEP Ewall Petroleum Green Stripes
40x80 - 15 3/4"x31 1/2"



8EEM Ewall Moka Gold Stripes •
40x80 - 15 3/4"x31 1/2"



MARK

PORCELAIN TILES



Porcelain Tiles / Gres Porcellanato

COLOURED BODY PORCELAIN TILES - RECTIFIED MONOCALIBER
GRES PORCELLANATO COLORATO IN MASSA - RETTIFICATO MONOCALIBRO

Sizes	Thickness	Surface finish
60x60 cm - 23 ⁵ / ₈ "x23 ⁵ / ₈ "	± 9 mm	Matte R10 A
30x60 cm - 11 ³ / ₄ "x23 ⁵ / ₈ "	± 9 mm	Matte R10 A

MARK Porcelain Tiles / Gres Porcellanato

MATTE SURFACE / SUPERFICIE MATT

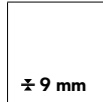

± 9 mm

60x60 cm 23⁵/₁₆"x23⁵/₁₆"

- AS6N Mark Gypsum 60 R10
- AS6O Mark Pearl 60 R10
- AS6P Mark Chrome 60 R10
- AS6Q Mark Clay 60 R10
- AS6S Mark Tobacco 60 R10
- AS6T Mark Graphite 60 R10

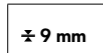

± 9 mm

30x60 cm 11³/₄"x23⁵/₁₆"

- D089 Mark Gypsum 30X60 R10
- D090 Mark Pearl 30X60 R10
- D091 Mark Chrome 30X60 R10
- D092 Mark Clay 30X60 R10
- D093 Mark Tobacco 30X60 R10
- D094 Mark Graphite 30X60 R10



GYPSUM



PEARL



CLAY



CHROME



TOBACCO

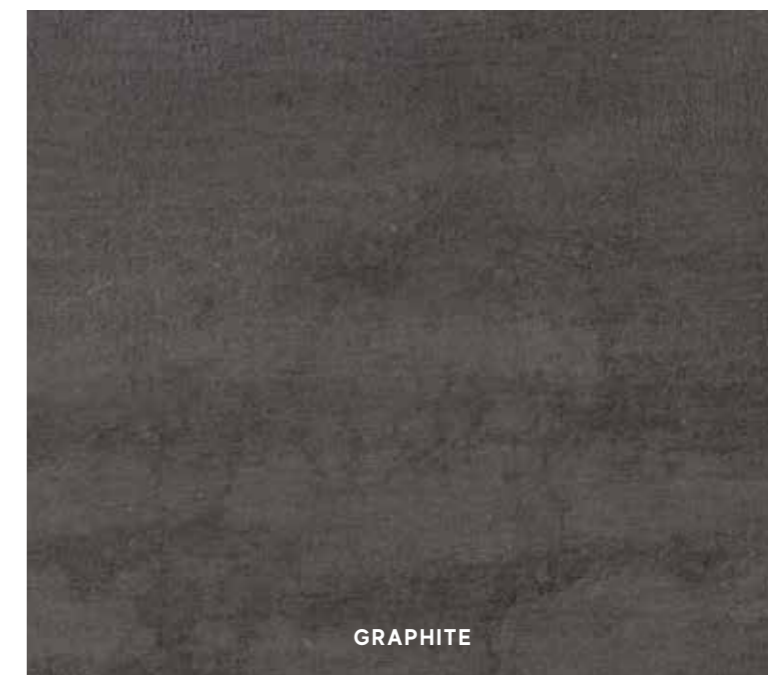

GRAPHITE



V3
MODERATE
VARIATION

MARK Porcelain Tiles / Gres Porcellanato

DECOR RANGE / GAMMA DECORI



AMX9 Mark Gypsum Mosaico Matt
30x30 - 11³/₄"x11³/₄"



AMYA Mark Pearl Mosaico Matt
30x30 - 11³/₄"x11³/₄"

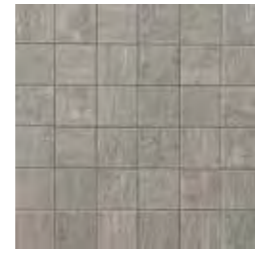

AMYB Mark Chrome Mosaico Matt
30x30 - 11³/₄"x11³/₄"

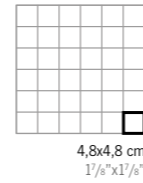

AMYC Mark Clay Mosaico Matt
30x30 - 11³/₄"x11³/₄"



AMYD Mark Tobacco Mosaico Matt
30x30 - 11³/₄"x11³/₄"



AMEY Mark Graphite Mosaico Matt
30x30 - 11³/₄"x11³/₄"



AM2K Mark Gypsum Esagono
30x35 - 11³/₄"x13³/₄"



AM2L Mark Pearl Esagono
30x35 - 11³/₄"x13³/₄"



AM2M Mark Chrome Esagono
30x35 - 11³/₄"x13³/₄"

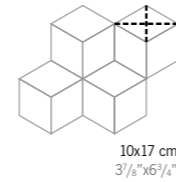

AM2N Mark Clay Esagono
30x35 - 11³/₄"x13³/₄"



AM2O Mark Tobacco Esagono
30x35 - 11³/₄"x13³/₄"



AM2P Mark Graphite Esagono
30x35 - 11³/₄"x13³/₄"



AMYR Mark Gypsum Brick
30x60 - 11³/₄"x23⁵/₈"



AMYU Mark Clay Brick
30x60 - 11³/₄"x23⁵/₈"



AMYS Mark Pearl Brick
30x60 - 11³/₄"x23⁵/₈"



AMYV Mark Tobacco Brick
30x60 - 11³/₄"x23⁵/₈"



AMYT Mark Chrome Brick
30x60 - 11³/₄"x23⁵/₈"



AMYW Mark Graphite Brick
30x60 - 11³/₄"x23⁵/₈"

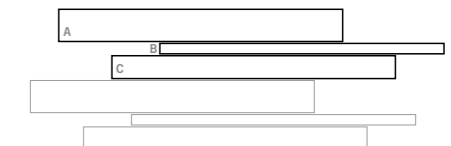

A 4,7x59,5 cm - 1⁷/₈"x11³/₈"
B 2,5x59,5 cm - 1"x23⁵/₈"
C 7,1x59,5 cm - 2⁷/₈"x23⁵/₈"



atlas concorde

• MULTI-THICKNESS MOSAIC, CLOSE JOINT INSTALLATION WITHOUT GROUTING.
MOSAICO MULTISPESORE, POSA SENZA STUCCATURA A GIUNTO UNITO.
Mosaïque multi-épaisseur, pose sans mastic avec joint nu.
Mosaik mit verschiedenen Stärken, fugentlose Verlegung ohne Mörtel.
Mosaico multiespesor, colocación sin mástique y sin juntas.
Мозаика разной толщины; укладка встык без затирки швов.

MARK Porcelain Tiles / Gres Porcellanato

DECOR RANGE / GAMMA DECORI

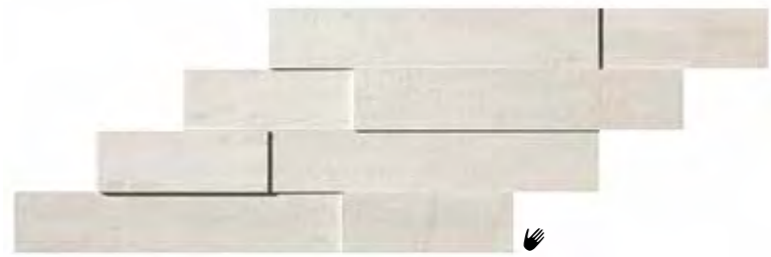

AM2R Mark Gypsum Brick 3D *
29x59 - 11³/₈"x23³/₄"



AM2U Mark Clay Brick 3D *
29x59 - 11³/₈"x23³/₄"



AM2S Mark Pearl Brick 3D *
29x59 - 11³/₈"x23³/₄"



AM2V Mark Tobacco Brick 3D *
29x59 - 11³/₈"x23³/₄"



AM2T Mark Chrome Brick 3D *
29x59 - 11³/₈"x23³/₄"





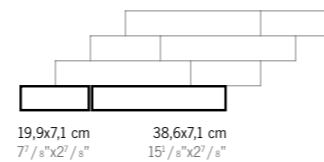





AM2W Mark Graphite Brick 3D *
29x59 - 11³/₈"x23³/₄"

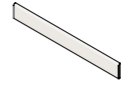
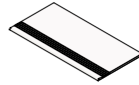
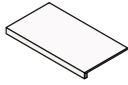
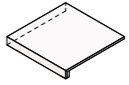

TRIM TILES / PEZZI SPECIALI

p. 568

UPEC p. 595

							
		Battiscopa 7,2x60 2 ⁷ / ₈ "x23 ³ / ₈ "	Gradino * 30x60 11 ³ / ₄ "x23 ³ / ₈ "	Scalino * 33x60 13"x23 ³ / ₈ "	Scalino Angolare * 33x33 13"x13"	Battiscopa Sag. Scala 7,2x30 - 2 ⁷ / ₈ "x11 ³ / ₄ "	
						DX *	SX *
	Gypsum	AMY9	AMØS	AM1K	AM1Q	AMZO	AMZW
	Pearl	AMZA	AMØT	AM1L	AM1R	AMZQ	AM1W
	Chrome	AMZC	AMØU	AM1M	AM1S	AMZR	AM1X
	Clay	AMZD	AMØV	AM1N	AM1T	AMZS	AM1Y
	Tobacco	AMZE	AMØW	AM1O	AM1U	AMZU	ANQY
	Graphite	AMZF	AMØX	AM1P	AM1V	AMZV	AM1Z

* THESE PARTS ARE SUPPLIED TO ORDER | I PEZZI SONO DISPONIBILI SU ORDINAZIONE | Les pièces sont disponibles sur commande | Die Teile sind auf Bestellung lieferbar | Las piezas se hacen por encargo | Изготавливаются на заказ



atlas concorde

mek
PORCELAIN&WALL TILES

Porcelain Tiles / Gres Porcellanato

COLOURED BODY PORCELAIN TILES - RECTIFIED MONOCALIBER
GRES PORCELLANATO COLORATO IN MASSA - RETTIFICATO MONOCALIBRO

LARGE SIZES p. 500

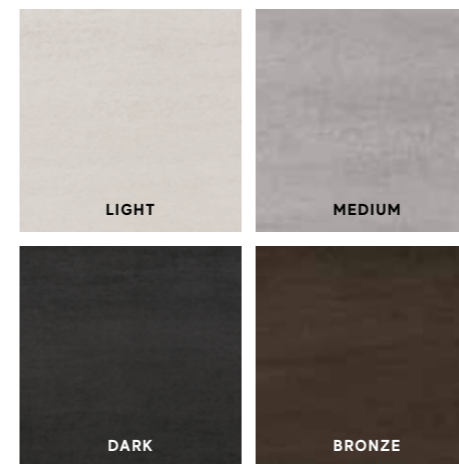

Sizes	Thickness	Surface finish
162x324 cm - 63 ³ / ₄ "x127 ¹ / ₂ " NON RECTIFIED - NON RETTIFICATO	± 12 mm	Matte
75x150 cm - 29 ¹ / ₂ "x59"	± 9 mm	Matte R10 A
45x90 cm - 17 ³ / ₄ "x35 ³ / ₈ "	± 9 mm	Matte R10 A
60x60 cm - 23 ⁵ / ₈ "x23 ⁵ / ₈ "	± 9 mm	Matte R10 A
30x60 cm - 11 ³ / ₄ "x23 ⁵ / ₈ "	± 9 mm	Matte R10 A

Wall Tiles / Rivestimento

WHITEBODY WALL TILES - RECTIFIED MONOCALIBER
RIVESTIMENTI IN PASTA BIANCA - RETTIFICATO MONOCALIBRO



Sizes	Thickness	Surface finish
50x120 cm - 19 ⁵ / ₈ "x47 ¹ / ₄ "	± 8,5 mm	Matte

3D Wall Tiles

Sizes	Thickness	Surface finish
50x120 cm - 19 ⁵ / ₈ "x47 ¹ / ₄ "	± 11 mm	Matte

COLOURED BODY PORCELAIN TILES | GRES PORCELLANATO COLORATO IN MASSA | Grès cérame coloré dans la masse | Durchgefärbtes Feinsteinzeug | Gres porcelánico coloreado en masa | Керамический гранит окрашенный в массу
 WHITEBODY WALL TILES | RIVESTIMENTI IN PASTA BIANCA | Revêtements en pâte blanche | Weißscherbige Wandfliesen | Revestimientos en pasta blanca | Настенная плитка из белой глины
 RECTIFIED MONOCALIBER | RETTIFICATO MONOCALIBRO | Rectifié mono-calibre | Geschliffen einkalibrig | Rectificado monocalibre | Ретифицированный в одном калибре
 NON RECTIFIED | NON RETTIFICATO | Non rectifié | Nicht rektifiziert | No rectificada | Неретифицированные

MEK Porcelain Tiles / Gres Porcellanato

MATTE SURFACE / SUPERFICIE MATT



atlasPLAN p. 500



MATTE / MATT
162x324 cm 63³/₄"x127¹/₂"
 > **NON RECTIFIED / NON RETTIFICATO**
 ANVR Mek Dark Matt ± 12 mm ST *
 ANVV Mek Medium Matt ± 12 mm ST *



75x150 cm 29¹/₂"x59"
 AT9Y Mek Light 75x150
 AT9Z Mek Medium 75x150
 AT9Ø Mek Bronze 75x150
 AT91 Mek Dark 75x150

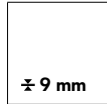

60x60 cm 23³/₈"x23³/₈"
 AUAA Mek Light 60x60
 AUAC Mek Medium 60x60
 AUAD Mek Bronze 60x60
 AUAF Mek Dark 60x60

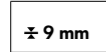

30x60 cm 11³/₄"x23³/₈"
 D226 Mek Light 30x60
 D227 Mek Medium 30x60
 D228 Mek Bronze 30x60
 D229 Mek Dark 30x60



45x90 cm 17³/₄"x35³/₈"
 AT96 Mek Light 45x90
 AT97 Mek Medium 45x90
 AT98 Mek Bronze 45x90
 AT99 Mek Dark 45x90

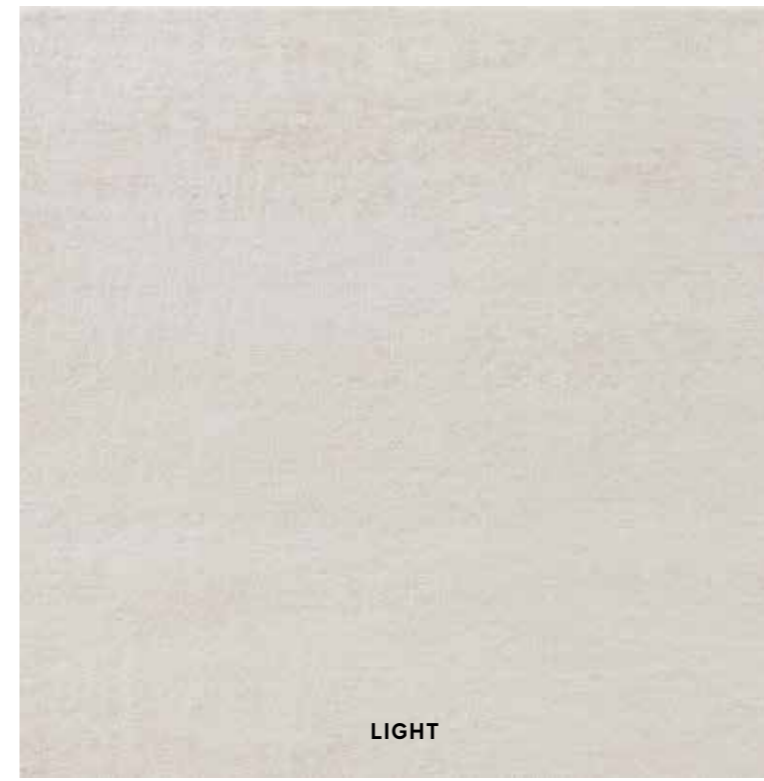

LIGHT

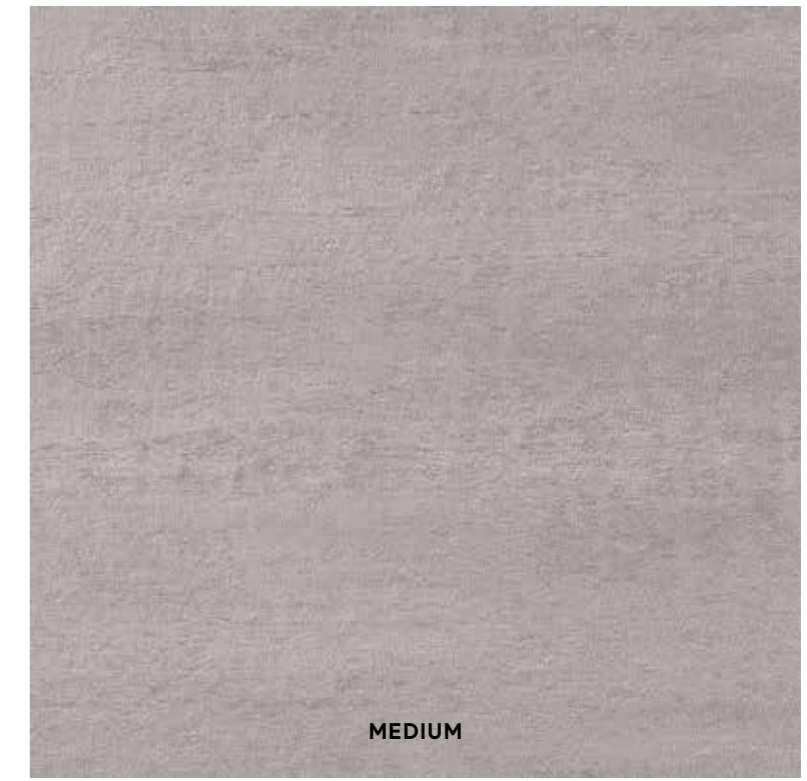

MEDIUM



BRONZE

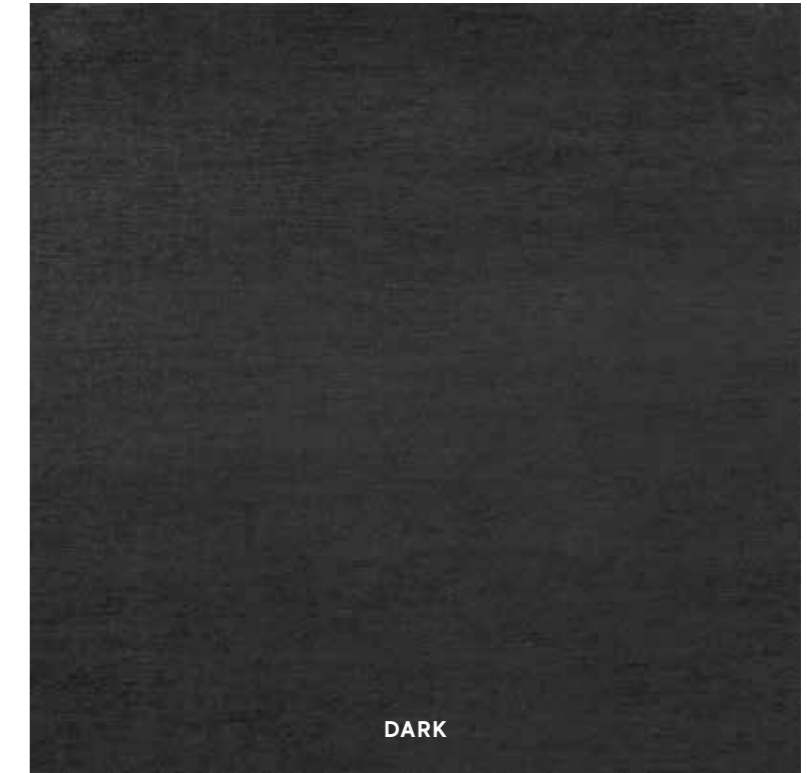

DARK



MATTE SURFACE | SUPERFICIE MATT | Surface Mat | Matt oberfläche | Superficie Mate | Матовая поверхность

* WITH FIBERGLASS MESH | VERSIONE STUOIATA | Version à nattes | Ausführung mit Glasfasermatte | Versión con malla | С упрочнением из стекловолоконна
 NON RECTIFIED | NON RETTIFICATO | Non rectifié | Nicht rektifiziert | No rectificada | Неретифицированные



V2
SLIGHT
VARIATION

MEK Porcelain Tiles / Gres Porcellanato

DECOR RANGE / GAMMA DECORI

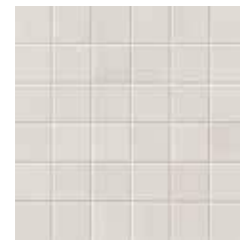

AMKY Mek Light Mosaico
30x30 - 11³/₄"x11³/₄"



AMKZ Mek Medium Mosaico
30x30 - 11³/₄"x11³/₄"

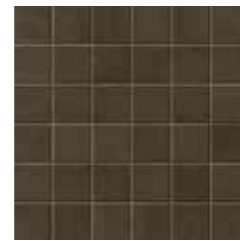

AMKØ Mek Bronze Mosaico
30x30 - 11³/₄"x11³/₄"

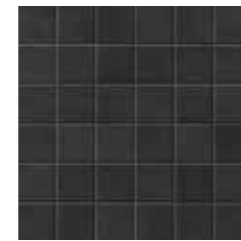

AMK1 Mek Dark Mosaico
30x30 - 11³/₄"x11³/₄"

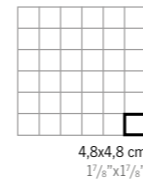

4,8x4,8 cm
1⁷/₈"x1⁷/₈"



AMKJ Mek Light Mosaico Zip
27x28 - 10⁵/₈"x11"



AMKK Mek Medium Mosaico Zip
27x28 - 10⁵/₈"x11"



AMKN Mek Bronze Mosaico Zip
27x28 - 10⁵/₈"x11"



AMKO Mek Dark Mosaico Zip
27x28 - 10⁵/₈"x11"

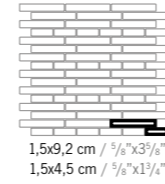

1,5x9,2 cm / 3/₈"x3³/₈"
1,5x4,5 cm / 1/₂"x1¹/₄"



AMKQ Mek Light Mosaico Prisma
36x36 - 14¹/₈"x14¹/₈"



AMKV Mek Medium Mosaico Prisma
36x36 - 14¹/₈"x14¹/₈"

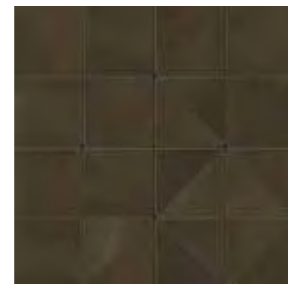

AMKW Mek Bronze Mosaico Prisma
36x36 - 14¹/₈"x14¹/₈"



AMKX Mek Dark Mosaico Prisma
36x36 - 14¹/₈"x14¹/₈"

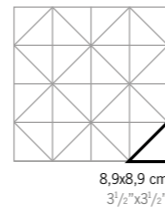

8,9x8,9 cm
3¹/₂"x3¹/₂"



AMKG Mek Light Esagono
30x35 - 11³/₄"x13³/₄"



AMKF Mek Medium Esagono
30x35 - 11³/₄"x13³/₄"



AMKH Mek Bronze Esagono
30x35 - 11³/₄"x13³/₄"



AMKI Mek Dark Esagono
30x35 - 11³/₄"x13³/₄"

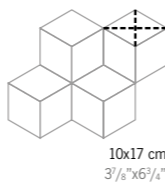

10x17 cm
3³/₈"x6⁷/₈"

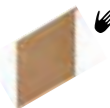

AMPJ Mek Rombo Gold *
10x17 - 3³/₈"x6⁷/₈"

* **LOOSE TILES TO ADD FREELY TO THE ESAGONO MOSAIC.**
TESSERE SFUSE DA INSERIRE LIBERAMENTE ALL'INTERNO DI MOSAICO ESAGONO.
Pièces à utiliser librement pour Mosaico Esagono.
Lose Steinchen, die frei innerhalb des Sechseckigen Mosaiks eingefügt werden können.
Teselas a granel para insertar libremente en el interior de Mosaico Hexagonal.
Мозаичные элементы для произвольного включения в мозаику Esagono.

THE DECORATION CAN ONLY BE LAID ON THE WALL | IL DECORO SI PUÒ POSARE SOLO A RIVESTIMENTO
Décor uniquement mural | Das Dekor kann nur an der Wand verlegt werden | La decoración se puede colocar únicamente en paredes | Декор может быть уложен только на стену.

TRIM TILES / PEZZI SPECIALI

p. 568

		Battiscopa 7,2x60 2 ⁷ / ₈ "x23 ⁵ / ₈ "	Battiscopa Digitale 4,6x60 1 ³ / ₄ "x23 ⁵ / ₈ "	Gradino * 30x60 11 ³ / ₄ "x23 ⁵ / ₈ "	Scalino * 33x150 13"x59"	Scalino * 33x60 13"x23 ⁵ / ₈ "	Scalino Angolare 33x33 - 13"x13"	DX *	SX *
Light	AMPN	AMPU	AMPY	AMQD	AMP9	AMQH	AMQL	AMQP	AMQT
Medium	AMPO	AMPV	AMPZ	AMQE	AMQA	AMQI	AMQM	AMQQ	AMQU
Bronze	AMPQ	AMPW	AMPØ	AMQF	AMQB	AMQJ	AMQN	AMQR	AMQV
Dark	AMPR	AMPX	AMP8	AMQG	AMQC	AMQK	AMQO	AMQS	AMQW

* THESE PARTS ARE SUPPLIED TO ORDER | PEZZI SONO DISPONIBILI SU ORDINAZIONE | Les pièces sont disponibles sur commande | Die Teile sind auf Bestellung lieferbar | Las piezas se hacen por encargo | Изготавливаются на заказ





mek
WALL TILES



Wall Tiles / Rivestimento

WHITEBODY WALL TILES - RECTIFIED MONOCALIBER
RIVESTIMENTI IN PASTA BIANCA - RETTIFICATO MONOCALIBRO

Sizes	Thickness	Surface finish
50x120 cm - 19 ⁵ / ₈ "x47 ¹ / ₄ "	± 8,5 mm	Matte

3D Wall Tiles

Sizes	Thickness	Surface finish
50x120 cm - 19 ⁵ / ₈ "x47 ¹ / ₄ "	± 11 mm	Matte

DECORATIVE RANGE / GAMMA DECORATIVA



MOSAICO Q WALL MOSAICO CHEVRON WALL MOSAICO DIAMOND WALL GOLD CIRCLES HEXAGON WALLPAPER



WHITEBODY WALL TILES | RIVESTIMENTI IN PASTA BIANCA | Revêtements en pâte blanche | Weißscherbige Wandfliesen | Revestimientos en pasta blanca | Настенная плитка из белой глины
RECTIFIED MONOCALIBER | RETTIFICATO MONOCALIBRO | Rectifié mono-calibre | Geschliffen einkalibrig | Rectificado monocalibré | Ретицированный в одном калибре

MEK Wall Tiles / Rivestimento

MATTE SURFACE / SUPERFICIE MATT



A4SQ Mek Light 50x120 50x120 cm - 19⁵/₈"x47¹/₄"



A4SR Mek Medium 50x120 50x120 cm - 19⁵/₈"x47¹/₄"



A4SS Mek Rose 50x120 50x120 cm - 19⁵/₈"x47¹/₄"



A4SP Mek Blue 50x120 50x120 cm - 19⁵/₈"x47¹/₄"

TRIM TILES / PEZZI SPECIALI

LMPK Mek Light Spigolo
0,8x25 cm - 3¹/₈"x8⁷/₈"

AMKL Mek Light Spigolo A.E.
0,8x0,8 cm - 3¹/₈"x3⁷/₈"

LMPH Mek Medium Spigolo
0,8x25 cm - 3¹/₈"x8⁷/₈"

AMKM Mek Medium Spigolo A.E.
0,8x0,8 cm - 3¹/₈"x3⁷/₈"

LMPQ Mek Rose Spigolo
0,8x25 cm - 3¹/₈"x8⁷/₈"

AMKR Mek Rose Spigolo A.E.
0,8x0,8 cm - 3¹/₈"x3⁷/₈"

LMPU Mek Blue Spigolo
0,8x25 cm - 3¹/₈"x8⁷/₈"

AMKU Mek Blue Spigolo A.E.
0,8x0,8 cm - 3¹/₈"x3⁷/₈"



V2
SLIGHT
VARIATION

MEK 3D Wall Tiles / Rivestimento 3D

MATTE SURFACE / SUPERFICIE MATT



A4S8 Mek 3D Fold Light 50x120 cm - 19⁵/₈"x47¹/₄"



A4R9 Mek 3D Fold Medium 50x120 cm - 19⁵/₈"x47¹/₄"



A4S9 Mek 3D Ultra Blade Rose 50x120 cm - 19⁵/₈"x47¹/₄"

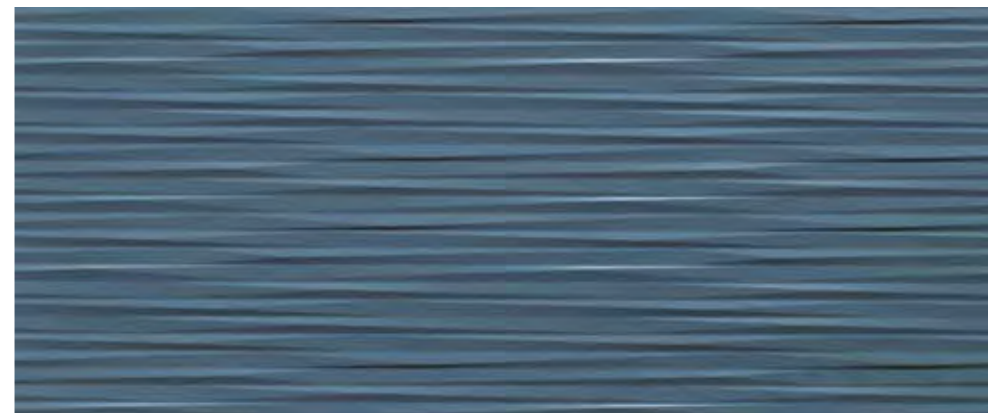

A4TA Mek 3D Ultra Blade Blue 50x120 cm - 19⁵/₈"x47¹/₄"

The 10 mm edge matches three-dimensional wall tiles having a 10-11 mm thickness / Lo spigolo 10 mm si abbina a rivestimenti tridimensionali di spessore 10-11 mm / Le bord 10 mm s'adapte aux revêtements tridimensionnels épaisseur 10-11 mm / Die 10 mm Kante ist mit dreidimensionalen Wandfliesen mit einer Dicke von 10-11 mm kombinierbar / La arista de 10 mm se combina con revestimientos tridimensionales de 10 -11 mm de grosor / Угловой элемент 10 мм сочетается с трехмерной настенной плиткой толщиной 10-11 мм

MATTE SURFACE | SUPERFICIE MATT | Surface Mat | Matt oberfläche | Superficie Mate | Матовая поверхность



V2
SLIGHT
VARIATION

TRIM TILES / PEZZI SPECIALI

LM1L Mek Light Spigolo 10mm •
1x20 cm - 3¹/₈"x7⁷/₈"

LM1M Mek Medium Spigolo 10mm •
1x20 cm - 3¹/₈"x7⁷/₈"

LM1R Mek Rose Spigolo 10mm •
1x20 cm - 3¹/₈"x7⁷/₈"

LM1U Mek Blue Spigolo 10mm •
1x20 cm - 3¹/₈"x7⁷/₈"

• THESE PARTS ARE SUPPLIED TO ORDER
I PEZZI SONO DISPONIBILI SU ORDINAZIONE
Les pièces sont disponibles sur commande
Die Teile sind auf Bestellung lieferbar
Las piezas se hacen por encargo
Изготавливаются на заказ

MEK Wall Tiles / Rivestimento

DECOR RANGE / GAMMA DECORI

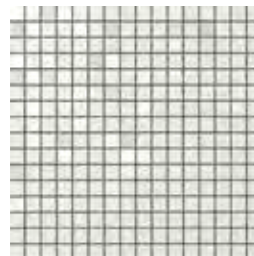

9MQL Mek Light Mosaico Q Wall
30,5x30,5 - 12"x12"

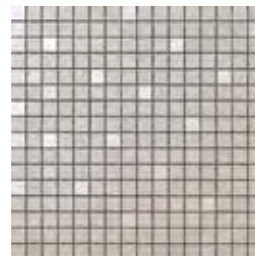

9MQM Mek Medium Mosaico Q Wall
30,5x30,5 - 12"x12"

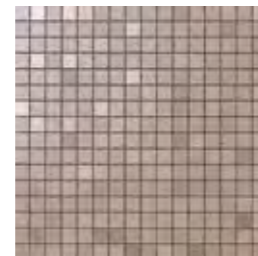

9MQR Mek Rose Mosaico Q Wall
30,5x30,5 - 12"x12"

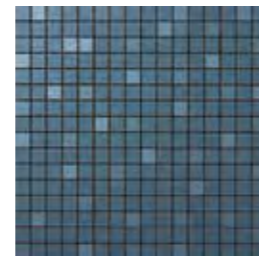

9MQU Mek Blue Mosaico Q Wall
30,5x30,5 - 12"x12"

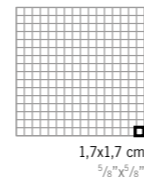

9MCH Mek Light Mosaico Chevron Wall
30,5x30,5 - 12"x12"



9MCE Mek Medium Mosaico Chevron Wall
30,5x30,5 - 12"x12"



9MCR Mek Rose Mosaico Chevron Wall
30,5x30,5 - 12"x12"

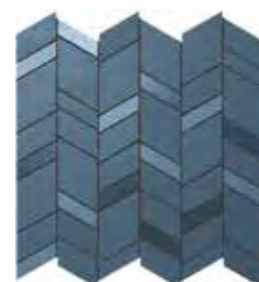

9MCU Mek Blue Mosaico Chevron Wall
30,5x30,5 - 12"x12"

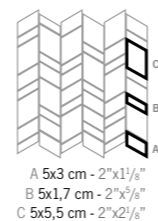

9MDL Mek Light Mosaico Diamond Wall
30,5x30,5 - 12"x12"



9MDM Mek Medium Mosaico Diamond Wall
30,5x30,5 - 12"x12"



9MDR Mek Rose Mosaico Diamond Wall
30,5x30,5 - 12"x12"



9MDU Mek Blue Mosaico Diamond Gold Wall
30,5x30,5 - 12"x12"

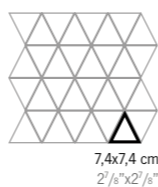

4MKC Mek Gold Circles
29x31 - 11 3/8"x12 1/4"



DECOR WITH GOLD INSERT.
 DECORO CON INSERTO IN ORO.
 Décor avec insert en OR.
 Dekor mit Einlage GOLD.
 Decoración con aplicación de ORO.
 Декор с ЗОЛОТОЙ вставкой.



A4T9 Mek Rose Hexagon
50x120 - 19 5/8"x47 1/4"



A4UA Mek Rose Wallpaper
50x120 - 19 5/8"x47 1/4"



A4UB Mek Blue Wallpaper
50x120 - 19 5/8"x47 1/4"



PRISM

With Prism, Atlas Concorde colors **the world of the resin effect with 13 soft tones**. The color palette, selected for Atlas Concorde by the Lissoni & Partners studio led by Piero Lissoni, makes it possible to design refined, bright environments combining shapes and colors in an innovative fusion that reflects the latest trends in contemporary design.

Con Prism, Atlas Concorde colora **il mondo dell'effetto resina con tredici tonalità morbide**. La palette cromatica, selezionata per Atlas Concorde dallo studio Lissoni&Partners guidato da Piero Lissoni, consente di progettare ambienti ricercati e luminosi, combinando forme e colori in una sintesi innovativa che interpreta al meglio le tendenze più attuali del design contemporaneo.



A COLOR CONCEPT BY PIERO LISSONI

“ We based the concept on the effect of light through a prism. These colors are what we imagined would be the result of prism light transformed into a rainbow. We then worked on this refracted light to try to reproduce it on the tile surface, a palette modified to become domestic colors or architectural colors.

Abbiamo provato a ragionare sull'effetto della luce attraverso un prisma, questi colori sono quello che ci siamo immaginati possa essere il risultato di una luce prismatica che si trasforma in un arcobaleno. Siamo poi intervenuti su questa rifrazione luminosa per cercare di portarla sulle superfici, una spezzettatura cromatica modificata per diventare colori domestici o colori dell'architettura.

Piero Lissoni





PRISM

PORCELAIN & WALL TILES



Porcelain Tiles / Gres Porcellanato

COLOURED BODY PORCELAIN TILES - RECTIFIED MONOCALIBER
GRES PORCELLANATO COLORATO IN MASSA - RETTIFICATO MONOCALIBRO

LARGE SIZES p. 500

Sizes	Thickness	Surface finish
120x278 cm - 47 ¹ / ₄ "x109 ¹ / ₂ "	± 6 mm	Matte R9 A
120x120 cm - 47 ¹ / ₄ "x47 ¹ / ₄ "	± 9 mm	Silk Matte R10 A+B
60x120 cm - 23 ⁵ / ₈ "x47 ¹ / ₄ "	± 9 mm	Matte R10 A+B
60x60 cm - 23 ⁵ / ₈ "x23 ⁵ / ₈ "	± 9 mm	Silk Matte R10 A+B
30x60 cm - 11 ³ / ₄ "x23 ⁵ / ₈ "	± 9 mm	Silk Matte R10 A+B

Outdoor Paving and Wet Areas

OUTDOOR PAVING p. 554

Sizes	Thickness	Surface finish
120x120 cm - 47 ¹ / ₄ "x47 ¹ / ₄ "	± 9 mm	Grip R11 A+B+C
120x120 cm - 47 ¹ / ₄ "x47 ¹ / ₄ "	± 20 mm	Textured R11 A+B+C
80x80 cm - 31 ¹ / ₂ "x31 ¹ / ₂ "	± 20 mm	Textured R11 A+B+C

GLAZED PORCELAIN TILES
GRES PORCELLANATO SMALTATO

Sizes	Thickness	Surface finish
120x278 cm - 47 ¹ / ₄ "x109 ¹ / ₂ "	± 6 mm	Matte



Wall Tiles / Rivestimento

WHITEBODY WALL TILES - RECTIFIED MONOCALIBER
RIVESTIMENTI IN PASTA BIANCA - RETTIFICATO MONOCALIBRO

Sizes	Thickness	Surface finish
50x120 cm - 19 ⁵ / ₈ "x47 ¹ / ₄ "	± 8,5 mm	Matte

COLOURED BODY PORCELAIN TILES | GRES PORCELLANATO COLORATO IN MASSA | Grés cérame coloré dans la masse | Durchgefärbtes Feinsteinzeug | Gres porcelánico coloreado en masa | Керамический гранит окрашенный в массу
GLAZED PORCELAIN TILES | GRES PORCELLANATO SMALTATO | Grés cérame émaillé | Glasiertes Feinsteinzeug | Gres porcelánico esmaltado | Глазурованный керамический гранит
WHITEBODY WALL TILES | RIVESTIMENTI IN PASTA BIANCA | Revêtements en pâte blanche | Weißscherbige Wandfliesen | Revestimientos en pasta blanca | Настенная плитка из белой глины
RECTIFIED MONOCALIBER | RETTIFICATO MONOCALIBRO | Rectifié mono-calibre | Geschliffen einkalibrig | Rectificado monocalibre | Ретицированный в одном калибре

PRISM Porcelain Tiles / Gres Porcellanato

MATTE SURFACE / SUPERFICIE MATT



120x278 cm 47¹/₄"x109¹/₂"
 A4UP Prism Suede 120x278
 A4UQ Prism Cord 120x278
 A4UR Prism Cotton 120x278
 A4US Prism Cloud 120x278
 A4UT Prism Fog 120x278
 A4UU Prism Graphite 120x278

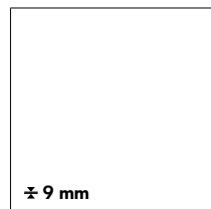

120x120 cm 47¹/₄"x47¹/₄"
 A40G Prism Suede 120x120
 A40H Prism Cord 120x120
 A40I Prism Cotton 120x120
 A40J Prism Cloud 120x120
 A40K Prism Fog 120x120
 A40L Prism Graphite 120x120



60x120 cm 23³/₈"x47¹/₄"
 A40S Prism Suede 60x120
 A40T Prism Cord 60x120
 A40U Prism Cotton 60x120
 A40V Prism Cloud 60x120
 A40W Prism Fog 60x120
 A40X Prism Graphite 60x120

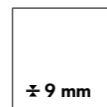

60x60 cm 23³/₈"x23³/₈"
 A4UV Prism Suede 60x60
 A4UW Prism Cord 60x60
 A4UX Prism Cotton 60x60
 A4UY Prism Cloud 60x60
 A4UZ Prism Fog 60x60
 A4UØ Prism Graphite 60x60

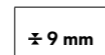

30x60 cm 11³/₄"x23³/₈"
 A4U1 Prism Suede 30x60
 A4U2 Prism Cord 30x60
 A4U3 Prism Cotton 30x60
 A4U4 Prism Cloud 30x60
 A4U5 Prism Fog 30x60
 A4U6 Prism Graphite 30x60



GRIP SURFACE / SUPERFICIE GRIP

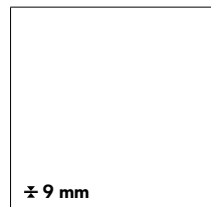

120x120 cm 47¹/₄"x47¹/₄"
 A50I Prism Suede 120x120 Grip
 A50J Prism Cord 120x120 Grip
 A50K Prism Cloud 120x120 Grip
 A50L Prism Fog 120x120 Grip



OUTDOOR PAVING ± 20 mm / PAVIMENTI DA ESTERNO ± 20 mm

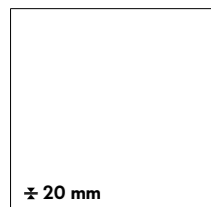

120x120 cm 47¹/₄"x47¹/₄"
 A50M Prism Suede 120x120 20mm
 A50N Prism Cord 120x120 20mm
 A50O Prism Cloud 120x120 20mm
 A50P Prism Fog 120x120 20mm

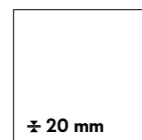

80x80 cm 31¹/₂"x31¹/₂"
 A56H Prism Suede 80x80 20mm
 A56I Prism Cord 80x80 20mm
 A56J Prism Cloud 80x80 20mm
 A56K Prism Fog 80x80 20mm



MATTE SURFACE | SUPERFICIE MATT | Surface Mat | Matt oberfläche | Superficie Mate | Матовая поверхность
GRIP SURFACE | SUPERFICIE GRIP | Surface grip | Grip oberfläche | Superficie Grip | Grip поверхность
OUTDOOR PAVING | PAVIMENTI DA ESTERNO | Sols d'extérieur | Bodenbeläge für Außenbereiche | Pavimentos para exteriores | Уличная плитка

MATTE



SUEDE



CORD



COTTON

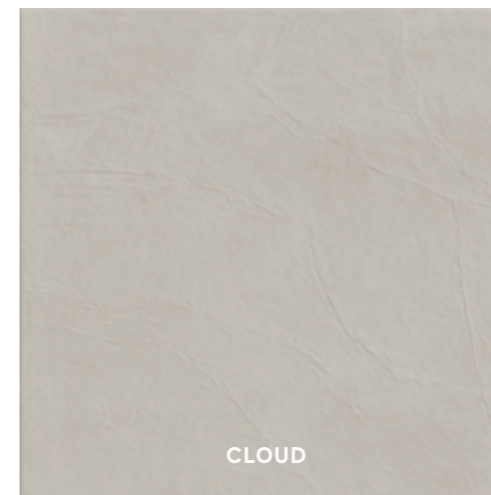

CLOUD



FOG

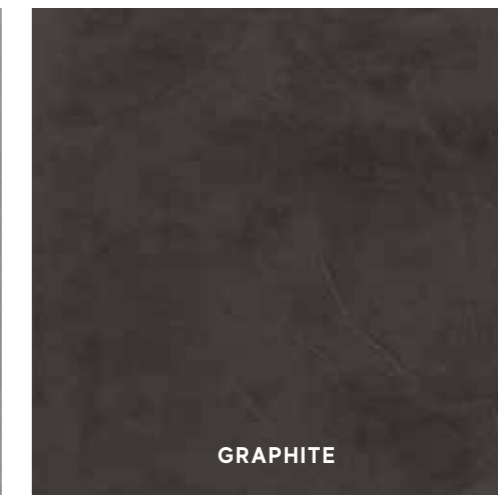

GRAPHITE

GRIP



SUEDE



CORD



CLOUD



FOG

OUTDOOR PAVING ± 20 mm



SUEDE



CORD



CLOUD



FOG

PRISM Porcelain Tiles / Gres Porcellanato

SILK SURFACE / SUPERFICIE SILK

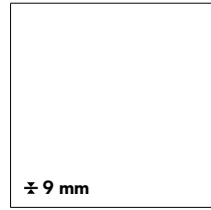

120x120 cm 47¹/₄"x47¹/₄"
 A40M Prism Suede 120x120 Silk
 A40N Prism Cord 120x120 Silk
 A40O Prism Cotton 120x120 Silk
 A40P Prism Cloud 120x120 Silk
 A40Q Prism Fog 120x120 Silk
 A40R Prism Graphite 120x120 Silk

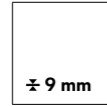

60x60 cm 23⁵/₈"x23⁵/₈"
 A5RV Prism Suede 60x60 Silk
 A5RW Prism Cord 60x60 Silk
 A5RX Prism Cotton 60x60 Silk
 A5RY Prism Cloud 60x60 Silk
 A5RZ Prism Fog 60x60 Silk
 A5RØ Prism Graphite 60x60 Silk

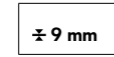

30x60 cm 11³/₄"x23⁵/₈"
 A5R2 Prism Suede 30x60 Silk
 A5R6 Prism Cord 30x60 Silk
 A5R7 Prism Cotton 30x60 Silk
 A5SA Prism Cloud 30x60 Silk
 A5SB Prism Fog 30x60 Silk
 A5SC Prism Graphite 30x60 Silk

Glazed Porcelain Tiles / Gres Porcellanato Smaltato

MATTE SURFACE / SUPERFICIE MATT

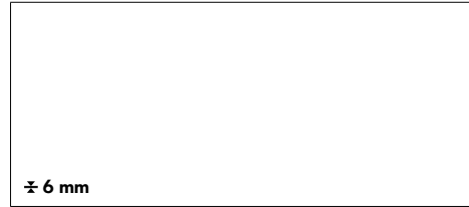

120x278 cm 47¹/₄"x109¹/₂" *
 A4VH Prism Bloom 120x278
 A4VI Prism Caramel 120x278
 A4VJ Prism Grape 120x278
 A4VK Prism Dusk 120x278
 A4VL Prism Midnight 120x278
 A4VM Prism Moss 120x278
 A4VN Prism Emerald 120x278

* THE USE OF A COMMON MILD DETERGENT IS RECOMMENDED. AVOID USING ACIDIC OR ALKALINE PRODUCTS, WAXES, STEEL WOOL, OR ABRASIVES.
 SI CONSIGLIA L'UTILIZZO DI UN COMUNE DETERGENTE NEUTRO. EVITARE L'UTILIZZO DI PRODOTTI ACIDI O ALCALINI, CERANTI, PAGLIETTE DI METALLO O ABRASIVE.
 Nous vous conseillons d'utiliser des détergents neutres courants. Éviter l'utilisation de cires et de produits acides ou alcalins, ainsi que les pailles métalliques ou abrasives.
 Es empfiehlt sich, ein haushaltsübliches, neutrales Reinigungsmittel zu verwenden. Saure oder alkalische Produkte, Wachs sowie Metallwolle- bzw. Scheuerschwämme sind zu vermeiden.
 Recomendamos utilizar un detergente neutro común. Hay que evitar el uso de productos ácidos o alcalinos, ceras y estropajos de metal o abrasivos.
 Рекомендуется чистить обычным нейтральным моющим средством. Не рекомендуется использовать кислотные, щелочные, восковые средства, а также металлические мочалки.

SILK SURFACE | SUPERFICIE SILK | Surface Silk | Silk oberfläche | Superficie Silk | Поверхность Silk
 MATTE SURFACE | SUPERFICIE MATT | Surface Mat | Matt oberfläche | Superficie Mate | Матовая поверхность



SILK



SUEDE



CORD

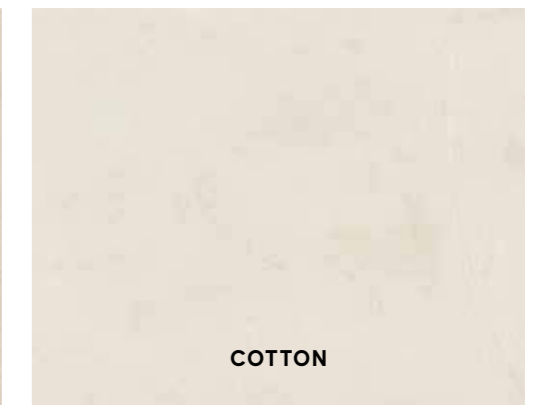

COTTON

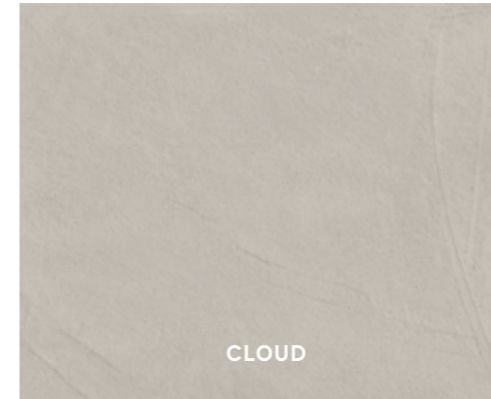

CLOUD



FOG

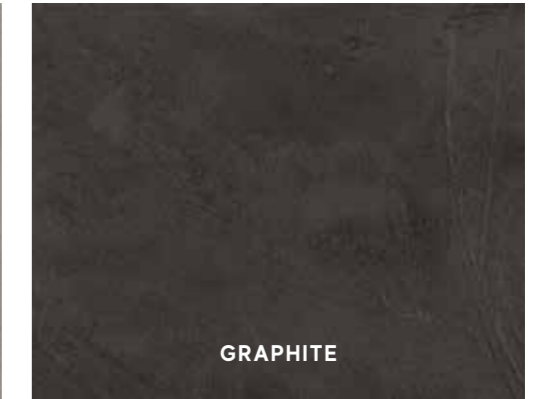

GRAPHITE

MATTE



BLOOM

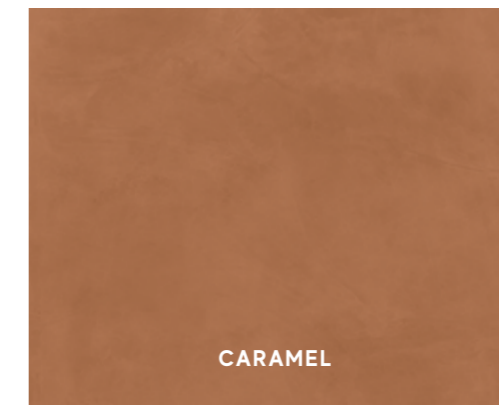

CARAMEL



GRAPE

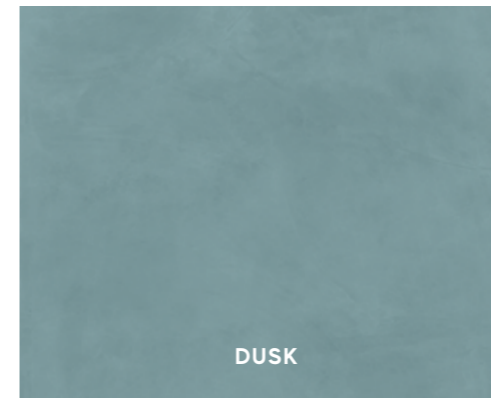

DUSK

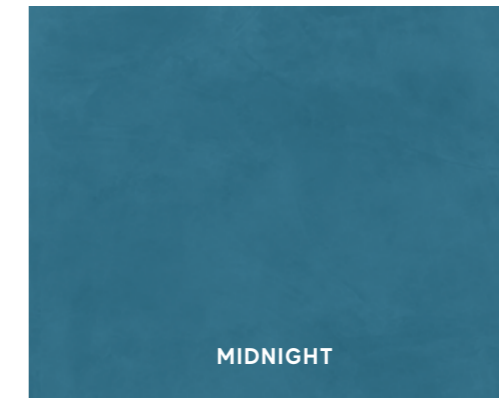

MIDNIGHT

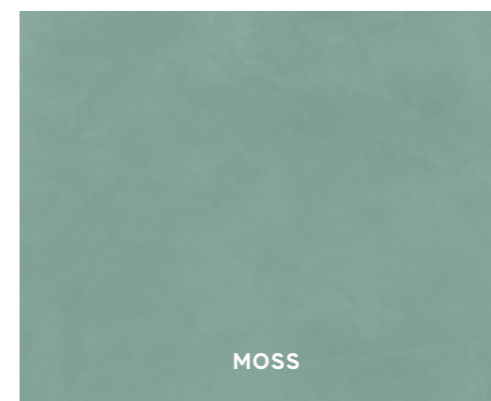

MOSS

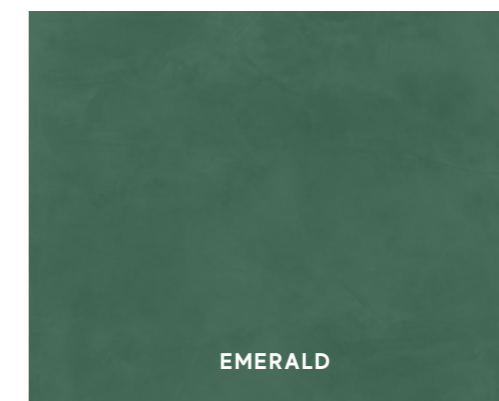

EMERALD

PRISM Porcelain Tiles / Gres Porcellanato

DECOR RANGE / GAMMA DECORI

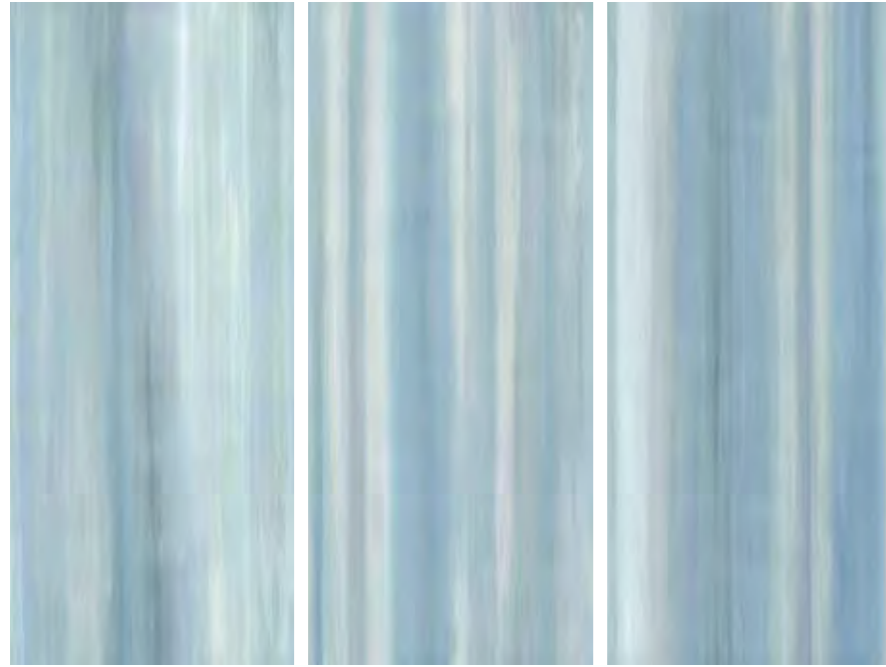

A4VO Prism Gradient XL 120x278 •
120x278 - 47¹/₄"x109¹/₂"

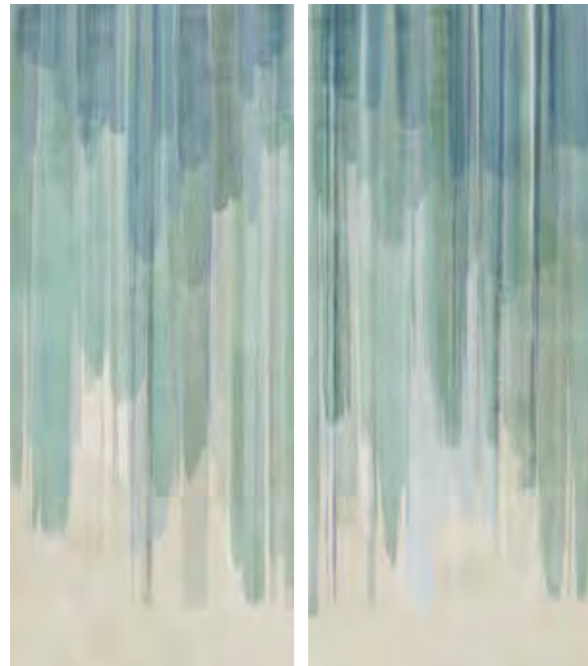

A4VP Prism Brush XL 120x278 •
120x278 - 47¹/₄"x109¹/₂"



• **THE USE OF A COMMON MILD DETERGENT IS RECOMMENDED. AVOID USING ACIDIC OR ALKALINE PRODUCTS, WAXES, STEEL WOOL, OR ABRASIVES.**
 SI CONSIGLIA L'UTILIZZO DI UN COMUNE DETERGENTE NEUTRO. EVITARE L'UTILIZZO DI PRODOTTI ACIDI O ALCALINI, CERANTI, PAGLIETTE DI METALLO O ABRASIVE.
 Nous vous conseillons d'utiliser des détergents neutres courants. Éviter l'utilisation de cires et de produits acides ou alcalins, ainsi que les pailles métalliques ou abrasives.
 Es empfiehlt sich, ein haushaltübliches, neutrales Reinigungsmittel zu verwenden. Saure oder alkalische Produkte, Wachs sowie Metallwolle- bzw. Scheuerschwämme sind zu vermeiden.
 Recomendamos utilizar un detergente neutro común. Hay que evitar el uso de productos ácidos o alcalinos, ceras y estropajos de metal o abrasivos.
 Рекомендуется чистить обычным нейтральным моющим средством. Не рекомендуется использовать кислотные, щелочные, восковые средства, а также металлические мочалки.

• **THE DECORATION CAN ONLY BE LAID ON THE WALL | IL DECORO SI PUÒ POSARE SOLO A RIVESTIMENTO**
 Décor uniquement mural | Das Dekor kann nur an der Wand verlegt werden | La decoración se puede colocar únicamente en paredes | Декор может быть уложен только на стену.



PRISM Porcelain Tiles / Gres Porcellanato

DECOR RANGE / GAMMA DECORI



A41S Prism Cotton
Mosaico Maze
31x35,7 - 12¹/₄"x14"



A41R Prism Cord
Mosaico Maze
31x35,7 - 12¹/₄"x14"



A41Q Prism Suede
Mosaico Maze
31x35,7 - 12¹/₄"x14"

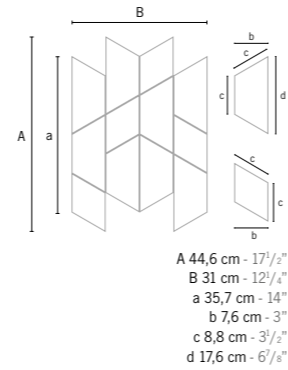

A41T Prism Cloud
Mosaico Maze
31x35,7 - 12¹/₄"x14"



A41U Prism Fog
Mosaico Maze
31x35,7 - 12¹/₄"x14"



A41V Prism Graphite
Mosaico Maze
31x35,7 - 12¹/₄"x14"



A41Y Prism Cotton
Mosaico Maze Silk
31x35,7 - 12¹/₄"x14"



A41X Prism Cord
Mosaico Maze Silk
31x35,7 - 12¹/₄"x14"



A41W Prism Suede
Mosaico Maze Silk
31x35,7 - 12¹/₄"x14"



A41Z Prism Cloud
Mosaico Maze Silk
31x35,7 - 12¹/₄"x14"



A411 Prism Fog
Mosaico Maze Silk
31x35,7 - 12¹/₄"x14"



A412 Prism Graphite
Mosaico Maze Silk
31x35,7 - 12¹/₄"x14"



A4V1 Prism Cotton
Mosaico Matt
30x30 - 11³/₄"x11³/₄"

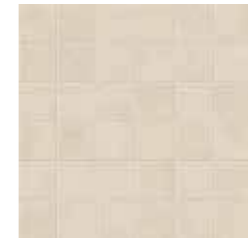

A4V0 Prism Cord
Mosaico Matt
30x30 - 11³/₄"x11³/₄"



A4VZ Prism Suede
Mosaico Matt
30x30 - 11³/₄"x11³/₄"

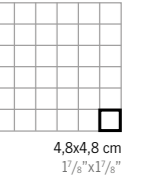

A4V2 Prism Cloud
Mosaico Matt
30x30 - 11³/₄"x11³/₄"

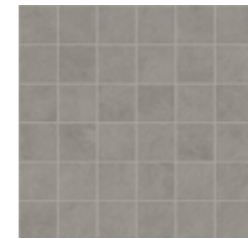

A4V3 Prism Fog
Mosaico Matt
30x30 - 11³/₄"x11³/₄"

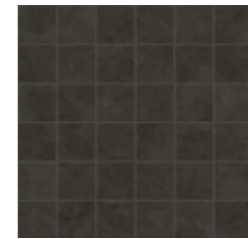

A4V4 Prism Graphite
Mosaico Matt
30x30 - 11³/₄"x11³/₄"

TRIM TILES / PEZZI SPECIALI

p. 568

UPEC p. 595

	Battiscopa 7,2x60 2 ⁷ / ₈ "x23 ⁵ / ₈ "		Gradino 30x60 11 ³ / ₄ "x23 ⁵ / ₈ "		Scalino 33x120 13"x47 ¹ / ₄ "		Scalino 33x60 13"x23 ⁵ / ₈ "		Scalino Angolare 33x33 13"x13"		Corner ± 6 mm * 1x120 - 3 ³ / ₈ "x47 ¹ / ₄ "	Corner A.E. ± 6 mm * 1x1 - 3 ³ / ₈ "x3 ³ / ₈ "	Battiscopa Sag. Scala 7,2x30 2 ⁷ / ₈ "x11 ³ / ₄ "				Elemento L Grip * 33x120 H. 4 13"x47 ¹ / ₄ " H. 1 ⁵ / ₈ "
	Matt	Silk	Matt *	Silk *	Matt *	Silk *	Matt *	Silk *	Matt *	Silk *			Matt *	Silk *	SX *	DX *	
Cotton	A4X0	A5SH	A4YI	A5SX	A4YU	A4Y6	A4YO	A5S3	A4Y0	A4ZD	A4ZJ	A4ZP	A4YC	A4X6	A5SR	A5SL	
Cord	A4XZ	A5SE	A4YH	A5SW	A4YT	A4Y5	A4YN	A5S2	A4YZ	A4ZC	A4ZI	A4ZO	A4YB	A4X5	A5SQ	A5SK	A5OZ
Suede	A4XY	A5SD	A4YG	A5SV	A4YS	A4Y4	A4YM	A5S1	A4YY	A4ZB	A4ZH	A4ZN	A4YA	A4X4	A5SP	A5SJ	A5OY
Cloud	A4X1	A5SF	A4YJ	A5SY	A4YV	A4Y7	A4YP	A5S4	A4Y1	A4ZE	A4ZK	A4ZQ	A4YD	A4X7	A5SS	A5SM	A5O0
Fog	A4X2	A5SG	A4YK	A5SZ	A4YW	A4Y9	A4YQ	A5S5	A4Y2	A4ZF	A4ZL	A4ZR	A4YE	A4X8	A5ST	A5SN	A5O1
Graphite	A4X3	A5SI	A4YL	A5S0	A4YX	A4ZA	A4YR	A5S6	A4Y3	A4ZG	A4ZM	A4ZS	A4YF	A4X9	A5SU	A5SO	

* THESE PARTS ARE SUPPLIED TO ORDER . I PEZZI SONO DISPONIBILI SU ORDINAZIONE ! Les pièces sont disponibles sur commande ! Die Teile sind auf Bestellung lieferbar ! Las piezas se hacen por encargo ! Изготавливаются на заказ



PRISM

WALL TILES



Wall Tiles / Rivestimento

WHITEBODY WALL TILES - RECTIFIED MONOCALIBER
RIVESTIMENTI IN PASTA BIANCA - RETTIFICATO MONOCALIBRO

Sizes	Thickness	Surface finish
50x120 cm - 19 ⁵ / ₈ "x47 ¹ / ₄ "	± 8,5 mm	Matte

DECORATIVE RANGE / GAMMA DECORATIVA

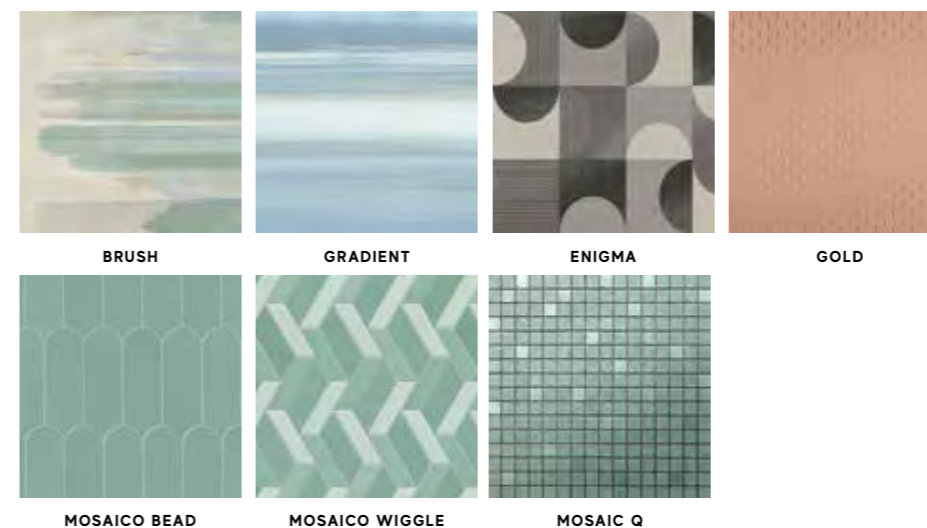

PRISM Wall Tiles / Rivestimento

MATTE SURFACE / SUPERFICIE MATT



A4TF Prism Suede 50x120
50x120 cm - 19⁵/₈"x47¹/₄"



A4TG Prism Cord 50x120
50x120 cm - 19⁵/₈"x47¹/₄"

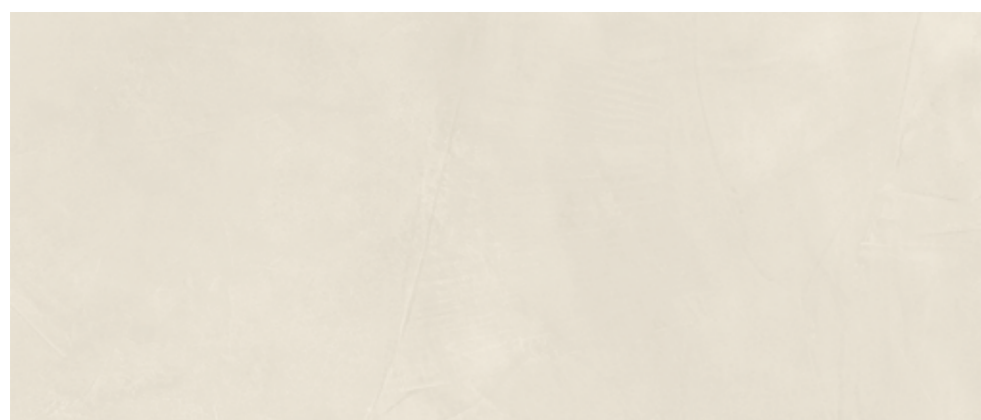

A4TH Prism Cotton 50x120
50x120 cm - 19⁵/₈"x47¹/₄"



A4TI Prism Cloud 50x120
50x120 cm - 19⁵/₈"x47¹/₄"

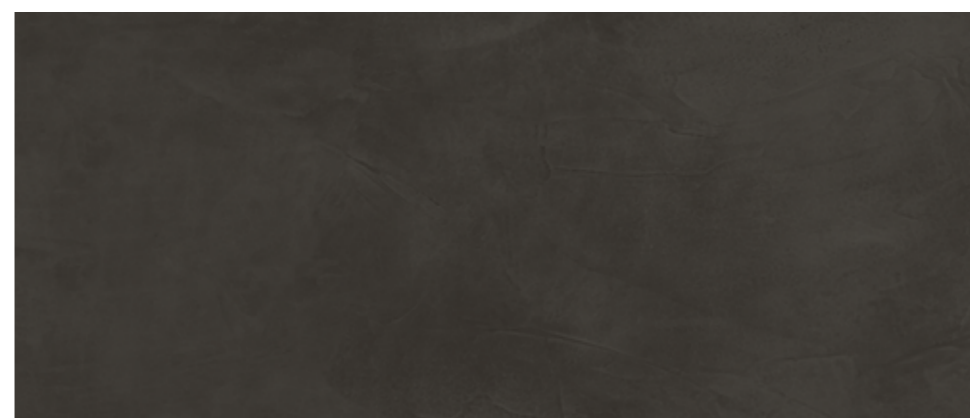

A4TJ Prism Graphite 50x120
50x120 cm - 19⁵/₈"x47¹/₄"



PRISM Wall Tiles / Rivestimento

MATTE SURFACE / SUPERFICIE MATT



A4TK Prism Bloom 50x120
50x120 cm - 19⁵/₈"x47¹/₄"

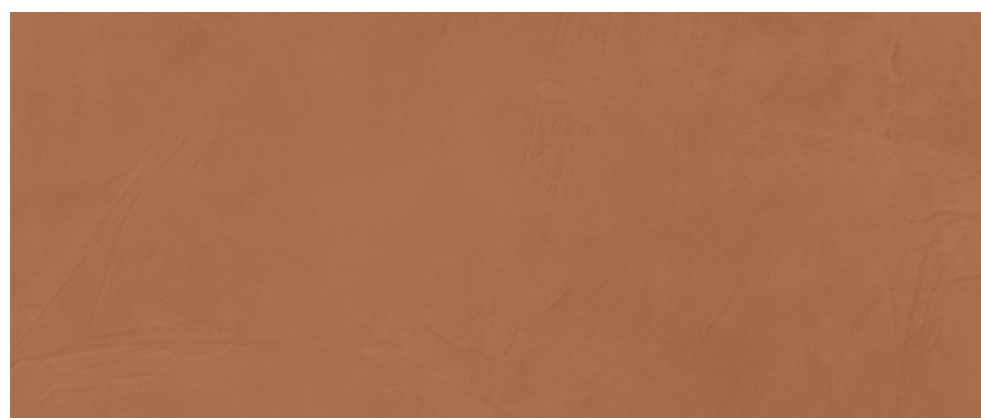

A4TL Prism Caramel 50x120
50x120 cm - 19⁵/₈"x47¹/₄"



A4TM Prism Grape 50x120
50x120 cm - 19⁵/₈"x47¹/₄"



V2
SLIGHT
VARIATION



A4TN Prism Dusk 50x120
50x120 cm - 19⁵/₈"x47¹/₄"



A4TO Prism Midnight 50x120
50x120 cm - 19⁵/₈"x47¹/₄"



A4TP Prism Moss 50x120
50x120 cm - 19⁵/₈"x47¹/₄"



A4TQ Prism Emerald 50x120
50x120 cm - 19⁵/₈"x47¹/₄"



V2
SLIGHT
VARIATION

PRISM Wall Tiles / Rivestimento

DECOR RANGE / GAMMA DECORI



A4TS Prism Brush 50x120 •
50x120 cm - 19⁵/₈"x47¹/₄"

8 patterns / 8 patterns



A4TR Prism Gradient 50x120 •
50x120 cm - 19⁵/₈"x47¹/₄"

12 patterns / 12 patterns

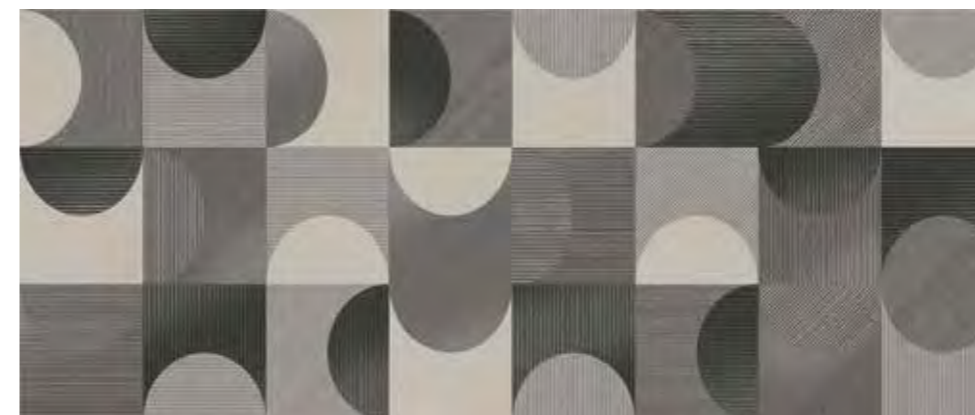

A4ZT Prism Enigma 50x120
50x120 cm - 19⁵/₈"x47¹/₄"

This item matches with the following colors / Questo articolo si abbina ai colori seguenti:
Cloud 50x120, Graphite 50x120, Cotton 50x120



A4ZU Prism Gold 50x120 ♦
50x120 cm - 19⁵/₈"x47¹/₄"

This item matches with the following colors / Questo articolo si abbina ai colori seguenti:
Bloom 50x120, Caramel 50x120, Grape 50x120, Cord 50x120, Cloud 50x120, Suede 50x120, Cotton 50x120

• Item sold by square meter. / Articolo venduto al mq. / Article vendu au mètre carré. / Artikel pro m verkauft. / Artículo vendido por m. / Артикул продается квадратными метрами.

♦ Contains gold. The use of a common mild detergent is recommended. Avoid using acidic or alkaline products, waxes, steel wool, or abrasives. / Parti in oro. Si consiglia l'utilizzo di un comune detergente neutro. Evitare l'utilizzo di prodotti acidi o alcalini, ceranti, pagliette di metallo o abrasive. / Parties dorées. Nous vous conseillons d'utiliser des détergents neutres courants. Éviter l'utilisation de cires et de produits acides ou alcalins, ainsi que les pailles métalliques ou abrasives. / Teile aus Gold. Es empfiehlt sich, ein haushaltsübliches, neutrales Reinigungsmittel zu verwenden. Saure oder alkalische Produkte, Wachs sowie Metallwolle- bzw. Scheuerschwämme sind zu vermeiden. / Partes doradas. Recomendamos utilizar un detergente neutro común. Hay que evitar el uso de productos ácidos o alcalinos, ceras y estropajos de metal o abrasivos. / Золотые детали. Рекомендуется чистить обычным нейтральным моющим средством. Не рекомендуется использовать кислотные, щелочные, восковые средства, а также металлические мочалки.

PRISM Wall Tiles / Rivestimento

DECOR RANGE / GAMMA DECORI



A4ZX Prism Cotton
Mosaico Bead
29,7x29,6 - 11⁵/₈"x11⁵/₈"



A4ZW Prism Cord
Mosaico Bead
29,7x29,6 - 11⁵/₈"x11⁵/₈"



A4ZV Prism Suede
Mosaico Bead
29,7x29,6 - 11⁵/₈"x11⁵/₈"



A4ZY Prism Cloud
Mosaico Bead
29,7x29,6 - 11⁵/₈"x11⁵/₈"

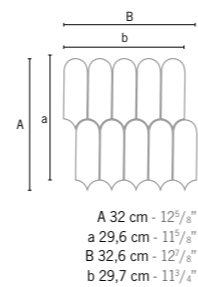

A4ZZ Prism Graphite
Mosaico Bead
29,7x29,6 - 11⁵/₈"x11⁵/₈"



A4ZØ Prism Bloom
Mosaico Bead
29,7x29,6 - 11⁵/₈"x11⁵/₈"



A4Z1 Prism Caramel
Mosaico Bead
29,7x29,6 - 11⁵/₈"x11⁵/₈"



A4Z2 Prism Grape
Mosaico Bead
29,7x29,6 - 11⁵/₈"x11⁵/₈"



A4Z3 Prism Dusk
Mosaico Bead
29,7x29,6 - 11⁵/₈"x11⁵/₈"



A4Z4 Prism Midnight
Mosaico Bead
29,7x29,6 - 11⁵/₈"x11⁵/₈"



A4Z5 Prism Moss
Mosaico Bead
29,7x29,6 - 11⁵/₈"x11⁵/₈"



A4Z6 Prism Emerald
Mosaico Bead
29,7x29,6 - 11⁵/₈"x11⁵/₈"



A4Z7 Prism Cotton
Wiggle
30,6x32,4 - 12"x12³/₄"



A4Z8 Prism Bloom
Wiggle
30,6x32,4 - 12"x12³/₄"



A4Z9 Prism Dusk
Wiggle
30,6x32,4 - 12"x12³/₄"



A4ØB Prism Moss
Wiggle
30,6x32,4 - 12"x12³/₄"

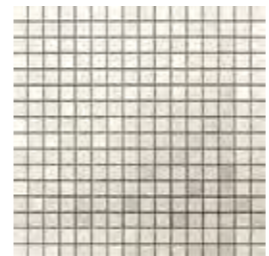
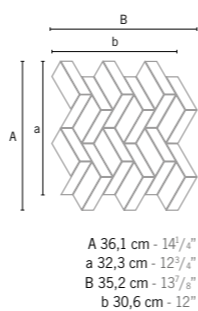

A4ØE Prism Cotton
Mosaic Q
30,5x30,5 - 12"x12"

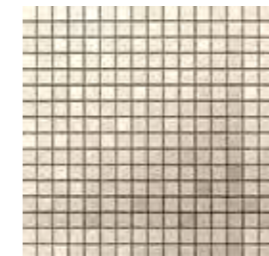

A4ØD Prism Cord
Mosaic Q
30,5x30,5 - 12"x12"

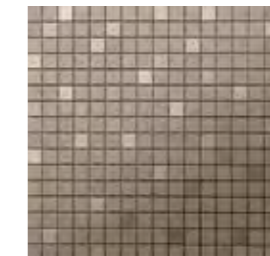

A4ØC Prism Suede
Mosaic Q
30,5x30,5 - 12"x12"

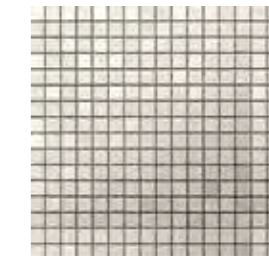

A4ØF Prism Cloud
Mosaic Q
30,5x30,5 - 12"x12"

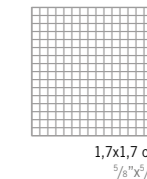

A4ØG Prism Graphite
Mosaic Q
30,5x30,5 - 12"x12"

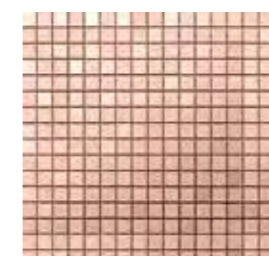

A4ØH Prism Bloom
Mosaic Q
30,5x30,5 - 12"x12"

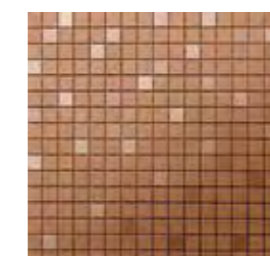

A4ØI Prism Caramel
Mosaic Q
30,5x30,5 - 12"x12"

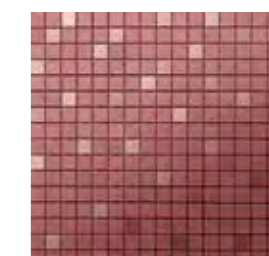

A4ØJ Prism Grape
Mosaic Q
30,5x30,5 - 12"x12"

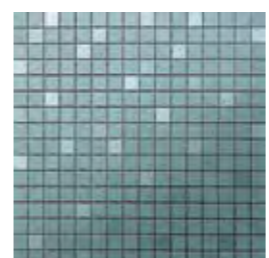

A4ØK Prism Dusk
Mosaic Q
30,5x30,5 - 12"x12"

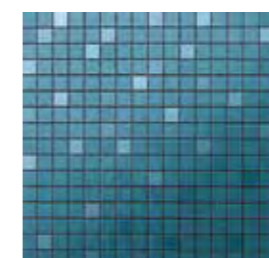

A4ØL Prism Midnight
Mosaic Q
30,5x30,5 - 12"x12"

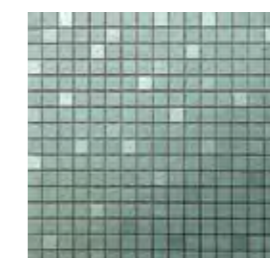

A4ØM Prism Moss
Mosaic Q
30,5x30,5 - 12"x12"

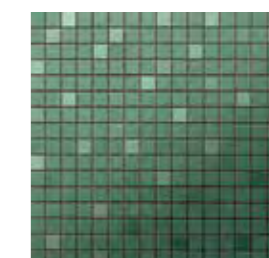

A4ØN Prism Emerald
Mosaic Q
30,5x30,5 - 12"x12"

TRIM TILES / PEZZI SPECIALI

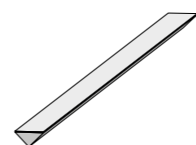

- 1,4x50 cm - 5/8"x19⁵/₈"
- A4Ø0 Prism Suede Corner 50 *
 - A4ØP Prism Cord Corner 50 *
 - A4ØQ Prism Cotton Corner 50 *
 - A4ØR Prism Cloud Corner 50 *
 - A4ØS Prism Graphite Corner 50 *
 - A4ØT Prism Bloom Corner 50 *
 - A4ØU Prism Caramel Corner 50 *
 - A4ØV Prism Grape Corner 50 *
 - A4ØW Prism Dusk Corner 50 *
 - A4ØX Prism Midnight Corner 50 *
 - A4ØY Prism Moss Corner 50 *
 - A4ØZ Prism Emerald Corner 50 *



- 1,4x1,4 cm - 5/8"x5/8"
- A4Ø1 Prism Suede Corner A.E. *
 - A4Ø2 Prism Cord Corner A.E. *
 - A4Ø3 Prism Cotton Corner A.E. *
 - A4Ø4 Prism Cloud Corner A.E. *
 - A4Ø5 Prism Graphite Corner A.E. *
 - A4Ø6 Prism Bloom Corner A.E. *
 - A4Ø7 Prism Caramel Corner A.E. *
 - A4Ø8 Prism Grape Corner A.E. *
 - A4Ø9 Prism Dusk Corner A.E. *
 - A41A Prism Midnight Corner A.E. *
 - A41B Prism Moss Corner A.E. *
 - A41C Prism Emerald Corner A.E. *

* THESE PARTS ARE SUPPLIED TO ORDER . I PEZZI SONO DISPONIBILI SU ORDINAZIONE
Les pièces sont disponibles sur commande | Die Teile sind auf Bestellung lieferbar | Las piezas se hacen por encargo | Изготавливаются на заказ



atlas concorde

RAW

PORCELAIN&WALL TILES



Porcelain Tiles / Gres Porcellanato

COLOURED BODY PORCELAIN TILES - RECTIFIED MONOCALIBER
GRES PORCELLANATO COLORATO IN MASSA - RETTIFICATO MONOCALIBRO

LARGE SIZES p. 500

Sizes	Thickness	Surface finish
120x278 cm - 47 ¹ / ₄ "x109 ¹ / ₂ "	± 6 mm	Matte R9 A
120x120 cm - 47 ¹ / ₄ "x47 ¹ / ₄ "	± 9 mm	Matte R10 A+B
75x150 cm - 29 ¹ / ₂ "x59"	± 9 mm	Matte R10 A+B
75x75 cm - 29 ¹ / ₂ "x29 ¹ / ₂ "	± 9 mm	Matte R10 A+B
37,5x75 cm - 14 ³ / ₄ "x29 ¹ / ₂ "	± 9 mm	Matte R10 A+B
60x60 cm - 23 ⁵ / ₈ "x23 ⁵ / ₈ "	± 9 mm	Matte R10 A+B
30x60 cm - 11 ³ / ₄ "x23 ⁵ / ₈ "	± 9 mm	Matte R10 A+B

Outdoor Paving and Wet Areas

OUTDOOR PAVING p. 554

Sizes	Thickness	Surface finish
37,5x75 cm - 14 ³ / ₄ "x29 ¹ / ₂ "	± 9 mm	Grip R11 A+B+C
120x120 cm - 47 ¹ / ₄ "x47 ¹ / ₄ "	± 20 mm	Textured R11 A+B+C
60x120 cm - 23 ⁵ / ₈ "x47 ¹ / ₄ "	± 20 mm	Textured R11 A+B+C



Wall Tiles / Rivestimento

WHITEBODY WALL TILES - RECTIFIED MONOCALIBER
RIVESTIMENTI IN PASTA BIANCA - RETTIFICATO MONOCALIBRO

Sizes	Thickness	Surface finish
50x120 cm - 19 ⁵ / ₈ "x47 ¹ / ₄ "	± 8,5 mm	Matte

3D Wall Tiles

Sizes	Thickness	Surface finish
50x120 cm - 19 ⁵ / ₈ "x47 ¹ / ₄ "	± 10 mm	Matte

RAW Porcelain Tiles / Gres Porcellanato

MATTE SURFACE / SUPERFICIE MATT



120x278 cm 47¹/₄"x109¹/₂"

APMW Raw White 120x278
APMX Raw Pearl 120x278
APMY Raw Sand 120x278
APMZ Raw Mud 120x278

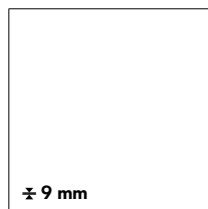

120x120 cm 47¹/₄"x47¹/₄"

APMK Raw White 120x120
APML Raw Pearl 120x120
APMU Raw Sand 120x120
APMV Raw Mud 120x120

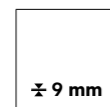

60x60 cm 23⁵/₈"x23⁵/₈"

APMB Raw White 60x60
APMD Raw Pearl 60x60
APME Raw Sand 60x60
APMF Raw Mud 60x60

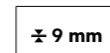

30x60 cm 11³/₄"x23⁵/₈"

APMG Raw White 30x60
APMH Raw Pearl 30x60
APMI Raw Sand 30x60
APMJ Raw Mud 30x60

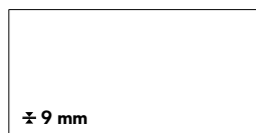

75x150 cm 29¹/₂"x59"

APKC Raw White 75x150
APKD Raw Pearl 75x150
APKE Raw Sand 75x150
APKF Raw Mud 75x150

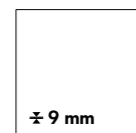

75x75 cm 29¹/₂"x29¹/₂"

APLW Raw White 75x75
APLX Raw Pearl 75x75
APLY Raw Sand 75x75
APLZ Raw Mud 75x75

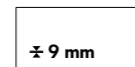

37,5x75 cm 14³/₄"x29¹/₂"

APL0 Raw White 37,5x75
APL1 Raw Pearl 37,5x75
APL2 Raw Sand 37,5x75
APL5 Raw Mud 37,5x75



MATTE / GRIP



WHITE



PEARL



SAND



MUD

GRIP SURFACE / SUPERFICIE GRIP



37,5x75 cm 14³/₄"x29¹/₂"

APL7 Raw White 37,5x75 Grip
APL8 Raw Pearl 37,5x75 Grip
APL9 Raw Sand 37,5x75 Grip
APMA Raw Mud 37,5x75 Grip

OUTDOOR PAVING ± 20 mm / PAVIMENTI DA ESTERNO ± 20 mm

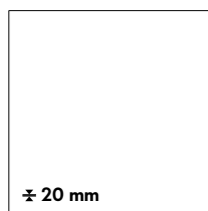

120x120 cm 47¹/₄"x47¹/₄"

A06K Raw White 120x120 20 mm
A06M Raw Pearl 120x120 20 mm
A06O Raw Sand 120x120 20 mm
A06P Raw Mud 120x120 20 mm

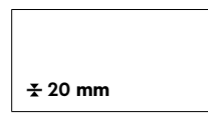

60x120 cm 23⁵/₈"x47¹/₄"

A0JO Raw White 60x120 20 mm
A0JP Raw Pearl 60x120 20 mm
A0JQ Raw Sand 60x120 20 mm
A0JR Raw Mud 60x120 20 mm



V3
MODERATE
VARIATION

OUTDOOR PAVING ± 20 mm



WHITE



PEARL



SAND



MUD

RAW Porcelain Tiles / Gres Porcellanato

DECOR RANGE / GAMMA DECORI

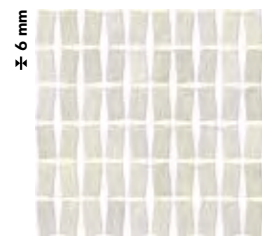

A00J Raw White Mosaico Castle *
29x29,2 - 11³/₈"x11³/₈"

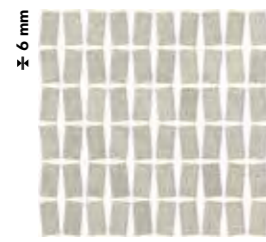

A00K Raw Pearl Mosaico Castle *
29x29,2 - 11³/₈"x11³/₈"

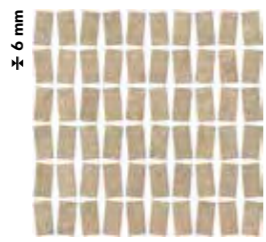

A00L Raw Sand Mosaico Castle *
29x29,2 - 11³/₈"x11³/₈"

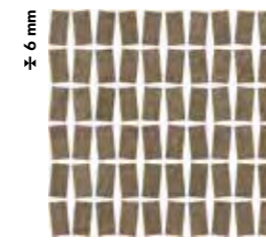

A00M Raw Mud Mosaico Castle *
29x29,2 - 11³/₈"x11³/₈"

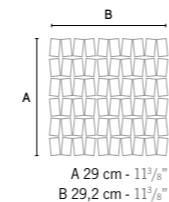

A0Z9 Raw White Mosaico Esagono
35,2x30,5 - 13⁷/₈"x12"



A00C Raw Pearl Mosaico Esagono
35,2x30,5 - 13⁷/₈"x12"



A00D Raw Sand Mosaico Esagono
35,2x30,5 - 13⁷/₈"x12"



A00E Raw Mud Mosaico Esagono
35,2x30,5 - 13⁷/₈"x12"

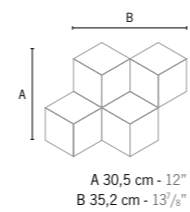

A0Z0 Raw White Mosaico Matt
30x30 - 11³/₄"x11³/₄"



A0Z6 Raw Pearl Mosaico Matt
30x30 - 11³/₄"x11³/₄"

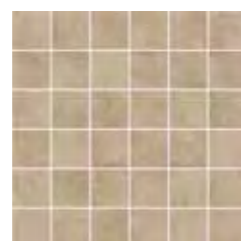

A0Z7 Raw Sand Mosaico Matt
30x30 - 11³/₄"x11³/₄"

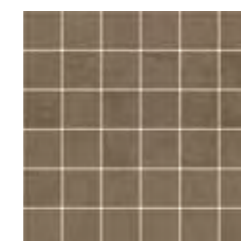

A0Z8 Raw Mud Mosaico Matt
30x30 - 11³/₄"x11³/₄"

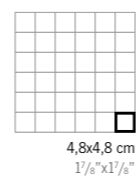

TRIM TILES / PEZZI SPECIALI

p. 568

UPEC p. 595

		Battiscopa 7,2x150 - 2 ⁷ / ₈ "x59"	Battiscopa 7,2x60 - 2 ⁷ / ₈ "x23 ⁵ / ₈ "	Gradino * 37,5x75 - 14 ³ / ₄ "x29 ¹ / ₂ "	Gradino * 30x60 - 11 ³ / ₄ "x23 ⁵ / ₈ "	Scalino * 37,5x150 - 14 ³ / ₄ "x59"	Scalino * 33x120 - 14 ³ / ₄ "x59"	Scalino * 33x60 - 13"x23 ⁵ / ₈ "	Scalino Angolare * 37,5x37,5 - 14 ³ / ₄ "x14 ³ / ₄ "	Scalino Angolare * 33x33 - 13"x13"	Corner ± 6 mm * 1x120 - 3 ¹ / ₈ "x47 ¹ / ₄ "	Corner A.E. ± 6 mm * 1x1 - 3 ³ / ₈ "x2 ¹ / ₈ "	Battiscopa Sag. Scala 7,2x30 - 2 ⁷ / ₈ "x11 ³ / ₄ "	Elemento L Grip * 15x75 H. 4 - 5 ⁷ / ₈ "x29 ¹ / ₂ "
		DX *	SX *											
White	A2AD	A199	A2AT	A2AP	A2A8	A2A4	A2AX	A2BG	A2BC	A191	A195	A2AL	A2AH	A2BK
Pearl	A2AE	A2AA	A2AU	A2AQ	A2A9	A2A5	A2AY	A2BH	A2BD	A192	A196	A2AM	A2AI	A2BL
Sand	A2AF	A2AB	A2AV	A2AR	A2BA	A2A6	A2AZ	A2BI	A2BE	A193	A197	A2AN	A2AJ	A2BM
Mud	A2AG	A2AC	A2AW	A2AS	A2BB	A2A7	A2A3	A2BJ	A2BF	A194	A198	A2AO	A2AK	A2BN

* These mosaics allow you to customize a wall by choosing the color of the grout during the laying phase. The colors presented in these pages are mood suggestions and purely indicative. / Questi mosaici permettono di personalizzare la parete attraverso la scelta del colore dello stucco durante la fase di posa. I colori presentati in queste pagine sono suggerimenti di mood e sono puramente indicativi. / Ces mosaïques permettent de personnaliser le mur moyennant le choix du coloris du joint pendant la phase de pose. Les coloris présentés sur ces pages sont des idées de mood fournies qu'à titre purement indicatif. / Diese Mosaik können zur Personalisierung der Wand mit Fugenmassen in Farben nach Wahl verfugt werden. Die auf diesen Seiten abgebildeten Farben verstehen sich als unverbindliche Beispiele für den erzielbaren Gesamteindruck. / Con estos mosaicos es posible llevar a cabo cualquier idea de personalización de la pared, con la elección del color del estuco durante la fase de colocación. Los colores que les presentamos en estas páginas son sugerencias de estados de ánimo ("mood") y puramente indicativos. / Эта мозаика позволяет индивидуализировать стену путем выбора цвета шовной затирки. Цвета, представленные на этих страницах, приведены в качестве примеров и носят ориентировочный характер.

* THESE PARTS ARE SUPPLIED TO ORDER | I PEZZI SONO DISPONIBILI SU ORDINAZIONE | Les pièces sont disponibles sur commande | Die Teile sind auf Bestellung lieferbar | Las piezas se hacen por encargo | Изготавливаются на заказ



RAW
WALL TILES



Wall Tiles / Rivestimento

WHITEBODY WALL TILES - RECTIFIED MONOCALIBER
RIVESTIMENTI IN PASTA BIANCA - RETTIFICATO MONOCALIBRO

Sizes	Thickness	Surface finish
50x120 cm - 19 ⁵ / ₈ "x47 ¹ / ₄ "	± 8,5 mm	Matte

3D Wall Tiles

Sizes	Thickness	Surface finish
50x120 cm - 19 ⁵ / ₈ "x47 ¹ / ₄ "	± 10 mm	Matte

DECORATIVE RANGE / GAMMA DECORATIVA



WHITEBODY WALL TILES | RIVESTIMENTI IN PASTA BIANCA | Revêtements en pâte blanche | Weißscherbige Wandfliesen | Revestimientos en pasta blanca | Настенная плитка из белой глины
RECTIFIED MONOCALIBER | RETTIFICATO MONOCALIBRO | Rectifié mono-calibre | Geschliffen einkalbrig | Rectificado monocalibre | Ретицированный в одном калибре

RAW Wall Tiles / Rivestimento

MATTE SURFACE / SUPERFICIE MATT



A4S2 Raw White 50x120
50x120 cm - 19⁵/₈"x47¹/₄"



A4SZ Raw Pearl 50x120
50x120 cm - 19⁵/₈"x47¹/₄"



A4S1 Raw Sand 50x120
50x120 cm - 19⁵/₈"x47¹/₄"



A4SX Raw Blue 50x120
50x120 cm - 19⁵/₈"x47¹/₄"



A4S0 Raw Rose 50x120
50x120 cm - 19⁵/₈"x47¹/₄"



A4SY Raw Petroleum 50x120
50x120 cm - 19⁵/₈"x47¹/₄"



V2
SLIGHT
VARIATION



V2
SLIGHT
VARIATION

RAW 3D Wall Tiles / Rivestimento 3D

MATTE SURFACE / SUPERFICIE MATT



A4TE Raw 3D Scratch White 50x120
50x120 cm - 19⁵/₈"x47¹/₄"



A4TD Raw 3D Scratch Pearl 50x120
50x120 cm - 19⁵/₈"x47¹/₄"

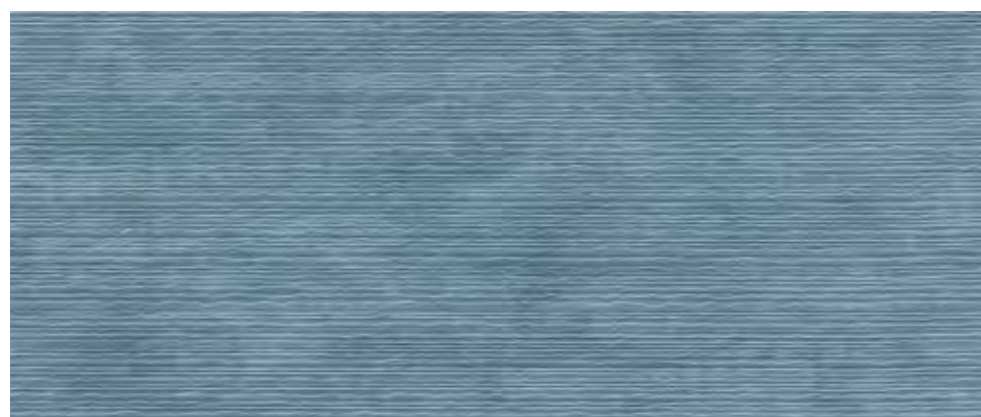

A4TB Raw 3D Scratch Blue 50x120
50x120 cm - 19⁵/₈"x47¹/₄"

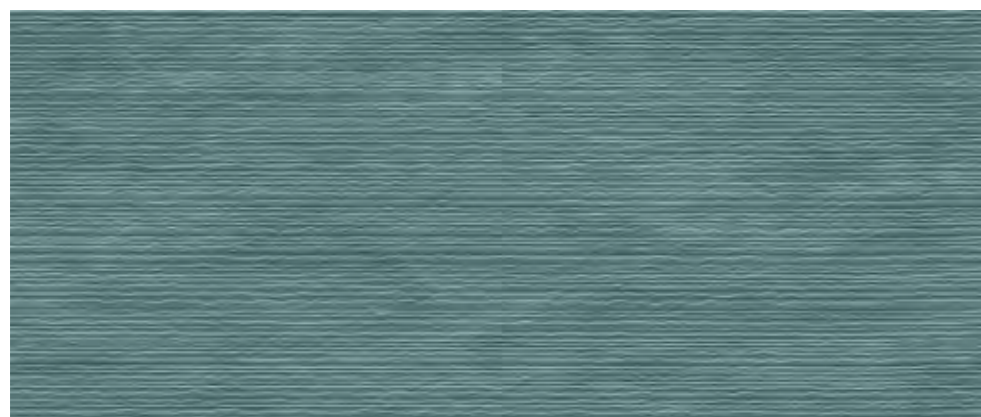

A4TC Raw 3D Scratch Petroleum 50x120
50x120 cm - 19⁵/₈"x47¹/₄"

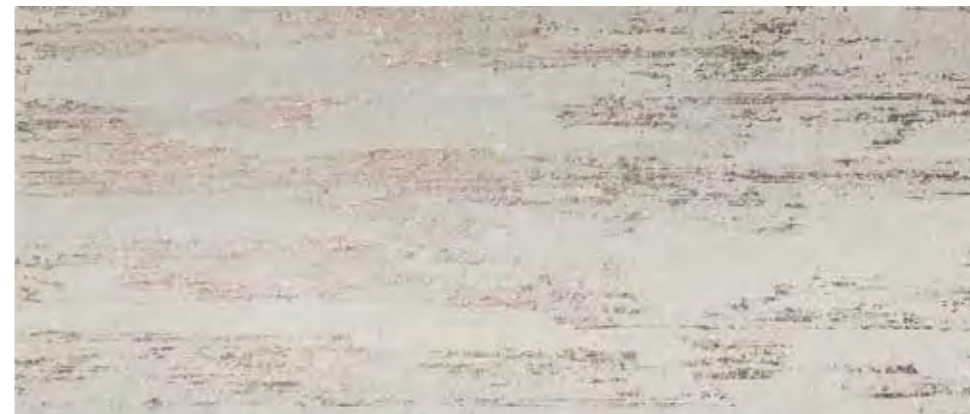

A4UG Raw Pearl Gold ♦
50x120 cm - 19⁵/₈"x47¹/₄"

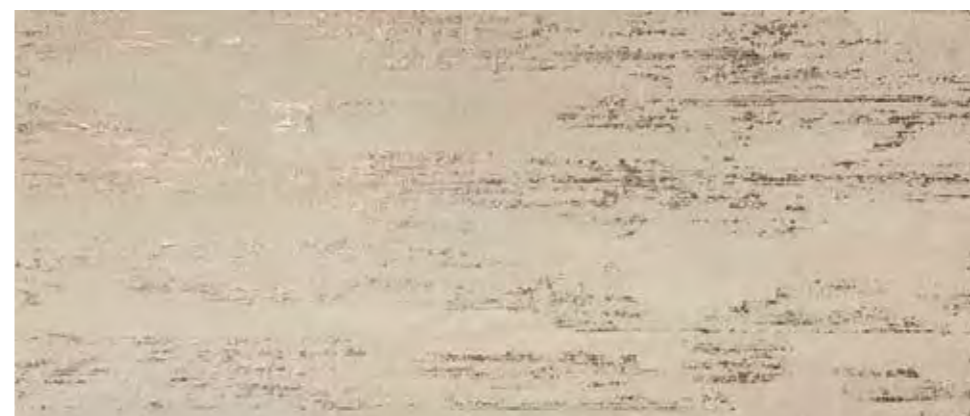

A4UH Raw Sand Gold ♦
50x120 cm - 19⁵/₈"x47¹/₄"



A4UF Raw Blue Gold ♦
50x120 cm - 19⁵/₈"x47¹/₄"



V2
SLIGHT
VARIATION

♦ Contains gold. The use of a common mild detergent is recommended. Avoid using acidic or alkaline products, waxes, steel wool, or abrasives. / Parti in oro. Si consiglia l'utilizzo di un comune detergente neutro. Evitare l'utilizzo di prodotti acidi o alcalini, ceranti, pagliette di metallo o abrasive. / Parties dorées. Nous vous conseillons d'utiliser des détergents neutres courants. Éviter l'utilisation de cires et de produits acides ou alcalins, ainsi que les pailles métalliques ou abrasives. / Teile aus Gold. Es empfiehlt sich, ein haushaltsübliches, neutrales Reinigungsmittel zu verwenden. Saure oder alkalische Produkte, Wachs sowie Metallwolle- bzw. Scheuerschwämme sind zu vermeiden. / Partes doradas. Recomendamos utilizar un detergente neutro común. Hay que evitar el uso de productos ácidos o alcalinos, ceras y estropajos de metal o abrasivos. / Золотые детали. Рекомендуется чистить обычным нейтральным моющим средством. Не рекомендуется использовать кислотные, щелочные, восковые средства, а также металлические мочалки.

RAW Wall Tiles / Rivestimento

DECOR RANGE / GAMMA DECORI



9RTW Raw White Twist *
35,8x31 - 14¹/₈"x12¹/₄"



9RTP Raw Pearl Twist *
35,8x31 - 14¹/₈"x12¹/₄"



9RTS Raw Sand Twist *
35,8x31 - 14¹/₈"x12¹/₄"



9RTB Raw Blue Twist *
35,8x31 - 14¹/₈"x12¹/₄"

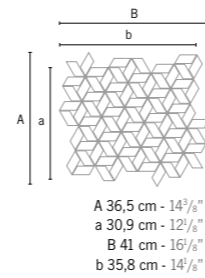

9RTR Raw Rose Twist *
35,8x31 - 14¹/₈"x12¹/₄"



9RTE Raw Petroleum Twist *
35,8x31 - 14¹/₈"x12¹/₄"



9RBW Raw White Block *
28x28 - 11"x11"



9RBP Raw Pearl Block *
28x28 - 11"x11"



9RBS Raw Sand Block *
28x28 - 11"x11"



9RBB Raw Blue Block *
28x28 - 11"x11"

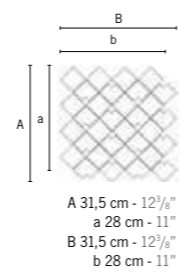

9RBO Raw Rose Block *
28x28 - 11"x11"



9RBE Raw Petroleum Block *
28x28 - 11"x11"



9RFW Raw White Flag *
31,1x31,6 - 12¹/₄"x12¹/₂"

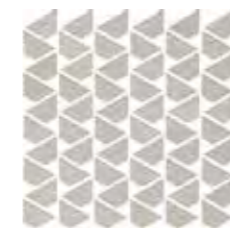

9RFP Raw Pearl Flag *
31,1x31,6 - 12¹/₄"x12¹/₂"



9RFS Raw Sand Flag *
31,1x31,6 - 12¹/₄"x12¹/₂"



9RFB Raw Blue Flag *
31,1x31,6 - 12¹/₄"x12¹/₂"



9RFR Raw Rose Flag *
31,1x31,6 - 12¹/₄"x12¹/₂"



9RFE Raw Petroleum Flag *
31,1x31,6 - 12¹/₄"x12¹/₂"

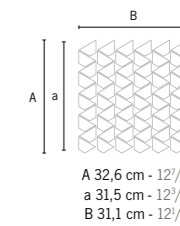

TRIM TILES / PEZZI SPECIALI

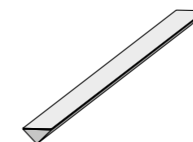

1,4x50 cm - 5⁵/₈"x19⁵/₈"

- LR1W Raw White Corner 50 *
- LR1P Raw Pearl Corner 50 *
- LR1S Raw Sand Corner 50 *
- LR1B Raw Blue Corner 50 *
- LR1R Raw Rose Corner 50 *
- LR1E Raw Petroleum Corner 50 *
- LR3W Raw 3D Scratch White Corner 50 *
- LR3A Raw 3D Scratch Pearl Corner 50 *
- LR3L Raw 3D Scratch Blue Corner 50 *
- LR3E Raw 3D Scratch Petroleum Corner 50 *

1,4x1,4 cm - 5⁵/₈"x5⁵/₈"

- A0RW Raw White Corner A.E. 1,4 *
- A0RP Raw Pearl Corner A.E. 1,4 *
- A0RS Raw Sand Corner A.E. 1,4 *
- A0RB Raw Blue Corner A.E. 1,4 *
- A0RR Raw Rose Corner A.E. 1,4 *
- A0RC Raw Petroleum Corner A.E. 1,4 *

* THESE PARTS ARE SUPPLIED TO ORDER. I PEZZI SONO DISPONIBILI SU ORDINAZIONE
Les pièces sont disponibles sur commande | Die Teile sind auf Bestellung lieferbar | Las piezas se hacen por encargo | Изготавливаются на заказ



atlasconcorde

* For the best performance of the mosaic we recommend the use of epoxy mortars (class RG - EN 13888/ISO 13007) or decorative resins-cement, following the manufacturer's instructions. / Al fine di ottenere una resa ottimale del mosaico, è consigliato l'utilizzo di malte epossidiche (classe RG - EN 13888/ISO 13007) o di resine cementizie attendendosi alle indicazioni di utilizzo fornite dal produttore. / Afin d'obtenir un rendu optimal de la mosaïque, nous vous conseillons d'utiliser des mortiers époxy (classe RG - EN 13888/ISO 13007) ou des résines à base de ciment, en suivant les indications d'utilisation fournies par le fabricant. / Um das Mosaik optimal zur Geltung zu bringen, empfehlen wir die Verwendung von Epoxidharzfugenmörtel (Klasse RG - EN 13888/ISO 13007) oder von vergüteten Fugenmörteln unter Beachtung der vom Hersteller angegebenen Verwendungshinweise. / Para obtener un rendimiento óptimo del mosaico, se aconseja utilizar mortero epoxi (clase RG - EN 13888/ISO 13007) o resinas de cemento siguiendo las indicaciones entregadas por el fabricante. / Для наилучшего эстетического результата при укладке мозаики рекомендуется использовать эпоксидные растворы (класс RG - EN 13888/ISO 13007) или полимерцемент, соблюдая инструкции производителя.

* For the best performance of the mosaic we recommend the use of epoxy mortars (class RG - EN 13888/ISO 13007) or decorative resins-cement, following the manufacturer's instructions. / Al fine di ottenere una resa ottimale del mosaico, è consigliato l'utilizzo di malte epossidiche (classe RG - EN 13888/ISO 13007) o di resine cementizie attendendosi alle indicazioni di utilizzo fornite dal produttore. / Afin d'obtenir un rendu optimal de la mosaïque, nous vous conseillons d'utiliser des mortiers époxy (classe RG - EN 13888/ISO 13007) ou des résines à base de ciment, en suivant les indications d'utilisation fournies par le fabricant. / Um das Mosaik optimal zur Geltung zu bringen, empfehlen wir die Verwendung von Epoxidharzfugenmörtel (Klasse RG - EN 13888/ISO 13007) oder von vergüteten Fugenmörteln unter Beachtung der vom Hersteller angegebenen Verwendungshinweise. / Para obtener un rendimiento óptimo del mosaico, se aconseja utilizar mortero epoxi (clase RG - EN 13888/ISO 13007) o resinas de cemento siguiendo las indicaciones entregadas por el fabricante. / Для наилучшего эстетического результата при укладке мозаики рекомендуется использовать эпоксидные растворы (класс RG - EN 13888/ISO 13007) или полимерцемент, соблюдая инструкции производителя.



atlas concorde

Venti boost

PORCELAIN TILES

Porcelain Tiles / Gres Porcellanato

COLOURED BODY PORCELAIN TILES - NON RECTIFIED
GRES PORCELLANATO COLORATO IN MASSA - NON RETTIFICATO

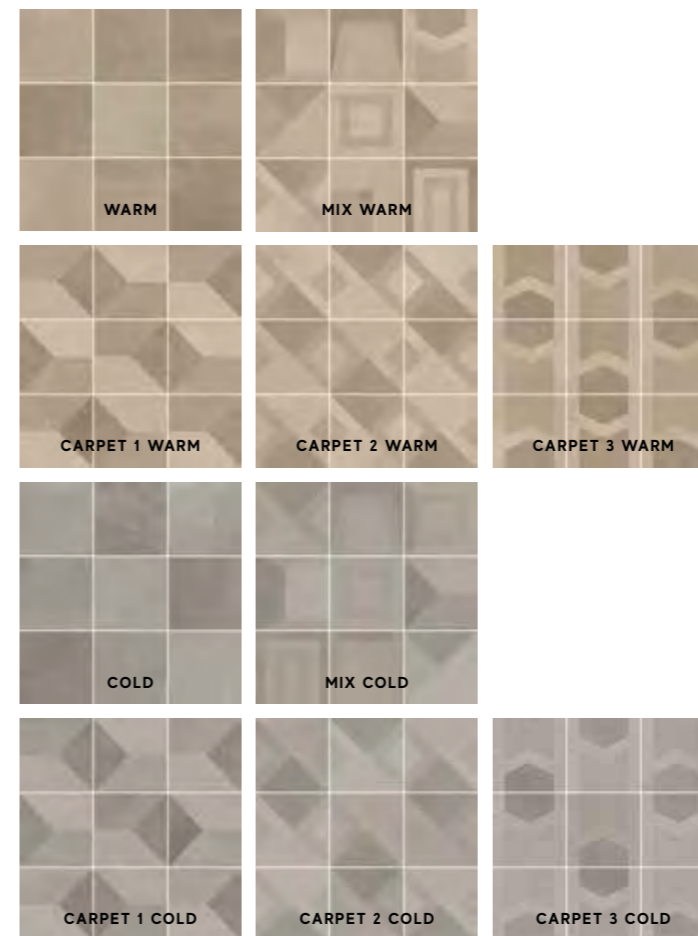

Sizes 20x20 cm - 7⁷/₈"x7⁷/₈"
Thickness ± 9 mm
Surface finish Matte R10 A

Glazed Porcelain Tiles / Gres Porcellanato Smaltato

GLAZED PORCELAIN TILES - NON RECTIFIED
GRES PORCELLANATO SMALTATO - NON RETTIFICATO

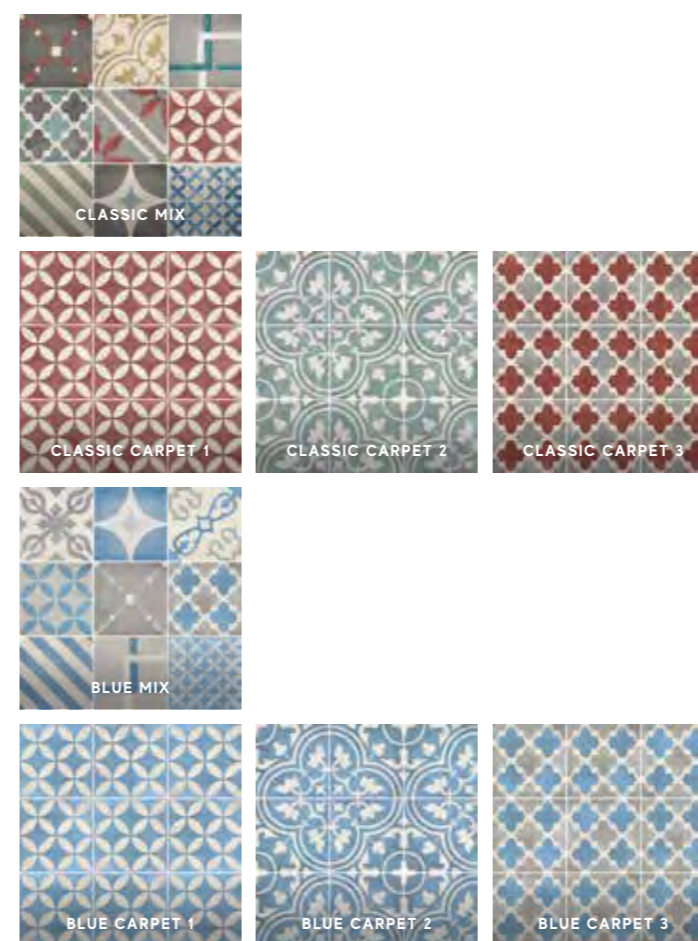

Sizes 20x20 cm - 7⁷/₈"x7⁷/₈"
Thickness ± 9 mm
Surface finish Matte R10 A

GLAZED PORCELAIN TILES | GRES PORCELLANATO SMALTATO | GRÉS CÉRAME EMAILLÉ | Glasiertes Feinsteinzeug | Gres porcelánico esmaltado | Лазурованный керамический гранит
COLOURED BODY PORCELAIN TILES | GRES PORCELLANATO COLORATO IN MASSA | Grés cérame coloré dans la masse | Durchgefärbtes Feinsteinzeug | Gres porcelánico coloreado en masa | Керамический гранит окрашенный в массу
NON RECTIFIED | NON RETTIFICATO | Non rectifié | Nicht rektifiziert | No rectificada | Неректифицированные

VENTI BOOST Porcelain Tiles / Gres Porcellanato

MATTE SURFACE / SUPERFICIE MATT



A30D Venti Boost Warm 20x20
20x20 - 7 7/8" x 7 7/8"



A30C Venti Boost Cold 20x20
20x20 - 7 7/8" x 7 7/8"



A30F Venti Boost Mix Warm 20x20 •
20x20 - 7 7/8" x 7 7/8"



A30J Venti Boost Carpet 1W 20x20
20x20 - 7 7/8" x 7 7/8"

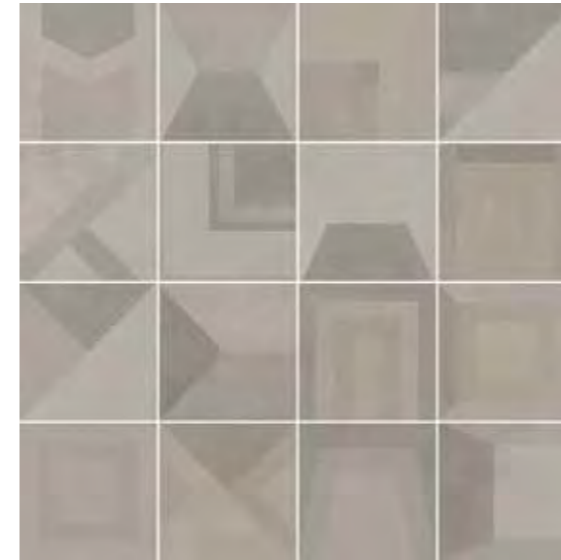

A30E Venti Boost Mix Cold 20x20 •
20x20 - 7 7/8" x 7 7/8"

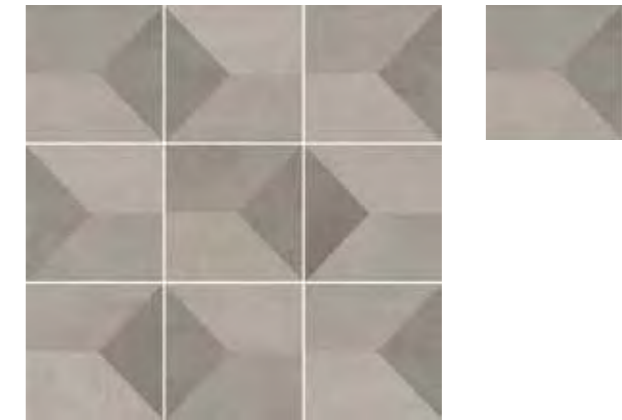

A30G Venti Boost Carpet 1C 20x20
20x20 - 7 7/8" x 7 7/8"

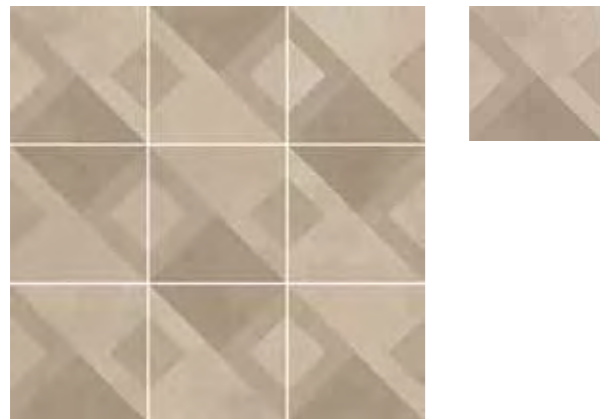

A30K Venti Boost Carpet 2W 20x20
20x20 - 7 7/8" x 7 7/8"



A30L Venti Boost Carpet 3W 20x20
20x20 - 7 7/8" x 7 7/8"

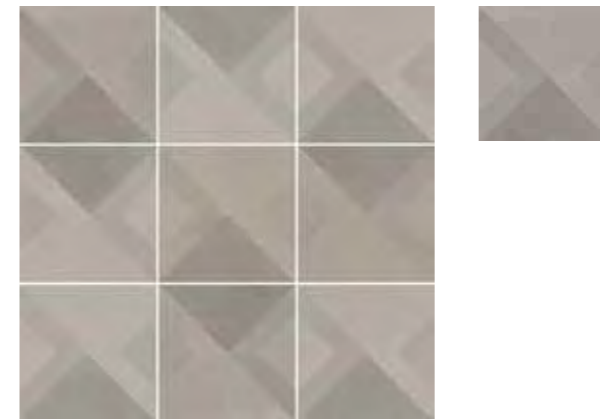

A30H Venti Boost Carpet 2C 20x20
20x20 - 7 7/8" x 7 7/8"



A30I Venti Boost Carpet 3C 20x20
20x20 - 7 7/8" x 7 7/8"



atlasconcorde



**V2
SLIGHT
VARIATION**
Carpet 1 Warm,
Carpet 2 Warm,
Carpet 3 Warm



**V4
SUBSTANTIAL
VARIATION**
Mix Warm



**V2
SLIGHT
VARIATION**
Carpet 1 Cold,
Carpet 2 Cold,
Carpet 3 Cold



**V4
SUBSTANTIAL
VARIATION**
Mix Cold

• Article composed of 16 different graphics, randomly mixed inside the boxes. / Articolo composto da 16 grafiche diverse, miscelate in modo casuale all'interno delle scatole. / Article composé de 16 graphismes différents, mélangés au hasard dans les boîtes. / Artikel mit 16 verschiedenen Grafiken, in den Schachteln nach dem Zufallsprinzip gemischt. / Artículo compuesto por 16 gráficos diferentes, mezclados en manera casual dentro a las cajas. / Артикул состоит из 16 различных рисунков, случайно перемешанных внутри коробок.

VENTI BOOST Glazed Porcelain Tiles / Gres Porcellanato Smaltato

MATTE SURFACE / SUPERFICIE MATT



A30M Venti Boost Classic Mix 20x20 •
20x20 - 7⁷/₈"x7⁷/₈"

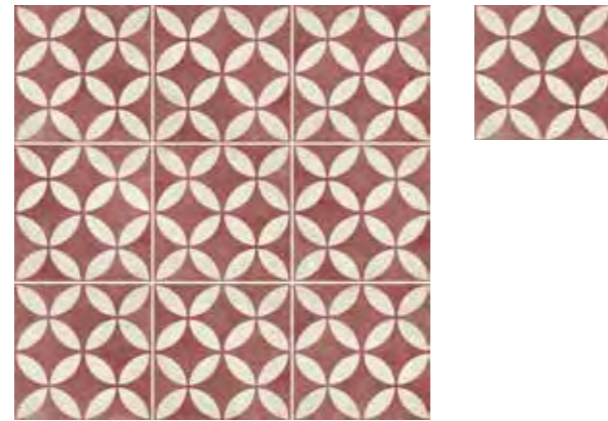

A30N Venti Boost Classic Carpet 1 20x20
20x20 - 7⁷/₈"x7⁷/₈"



A30Q Venti Boost Blue Mix 20x20 •
20x20 - 7⁷/₈"x7⁷/₈"

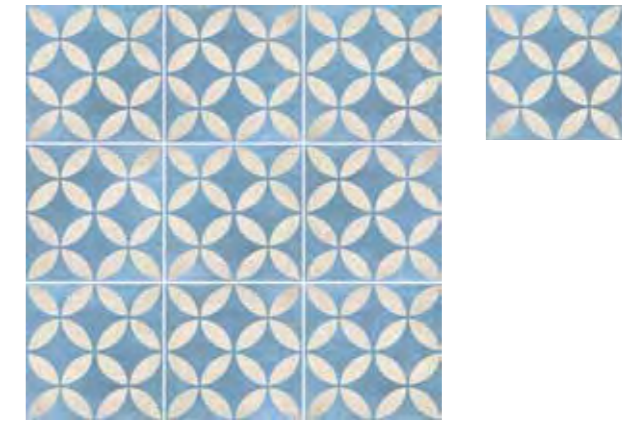

A30R Venti Boost Blue Carpet 1 20x20
20x20 - 7⁷/₈"x7⁷/₈"



A30O Venti Boost Classic Carpet 2 20x20
20x20 - 7⁷/₈"x7⁷/₈"

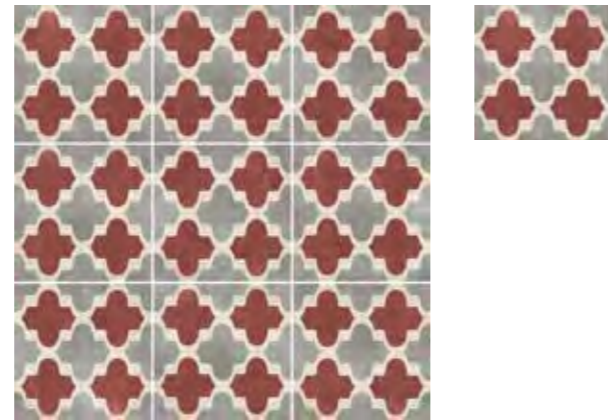

A30P Venti Boost Classic Carpet 3 20x20
20x20 - 7⁷/₈"x7⁷/₈"



A30S Venti Boost Blue Carpet 2 20x20
20x20 - 7⁷/₈"x7⁷/₈"



A30T Venti Boost Blue Carpet 3 20x20
20x20 - 7⁷/₈"x7⁷/₈"



**V2
SLIGHT
VARIATION**
Classic Carpet 1,
Classic Carpet 2,
Classic Carpet 3



**V4
SUBSTANTIAL
VARIATION**
Classic Mix



**V2
SLIGHT
VARIATION**
Blue Carpet 1,
Blue Carpet 2,
Blue Carpet 3



**V4
SUBSTANTIAL
VARIATION**
Blue Mix

• Article composed of 20 different graphics, randomly mixed inside the boxes. / Articolo composto da 20 grafiche diverse, miscelate in modo casuale all'interno delle scatole. / Article composé de 20 graphismes différents, mélangés au hasard dans les boîtes. / Artikel mit 20 verschiedenen Grafiken, in den Schachteln nach dem Zufallsprinzip gemischt. / Artículo compuesto por 20 gráficos diferentes, mezclados en manera casual dentro a las cajas. / Артикул состоит из 20 различных рисунков, случайно перемешанных внутри коробок.



atlas concorde

BLAZE

PORCELAIN & WALL TILES

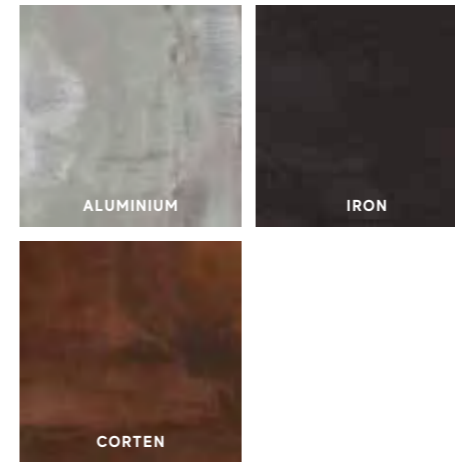

Porcelain Tiles / Gres Porcellanato

COLOURED BODY PORCELAIN TILES - RECTIFIED MONOCALIBER
GRES PORCELLANATO COLORATO IN MASSA - RETTIFICATO MONOCALIBRO

LARGE SIZES p. 500

Sizes	Thickness	Surface finish
162x324 cm - 63 ³ / ₄ "x127 ¹ / ₂ " NON RECTIFIED - NON RETTIFICATO	± 12 mm	Matte
120x278 cm - 47 ¹ / ₄ "x109 ¹ / ₂ "	± 6 mm	Matte R9 A
120x120 cm - 47 ¹ / ₄ "x47 ¹ / ₄ "	± 9 mm	Matte R10 A+B
75x150 cm - 29 ¹ / ₂ "x59"	± 9 mm	Polished Matte R10 A+B
75x75 cm - 29 ¹ / ₂ "x29 ¹ / ₂ "	± 9 mm	Polished Matte R10 A+B
37,5x75 cm - 14 ³ / ₄ "x29 ¹ / ₂ "	± 9 mm	Matte R10 A+B

Outdoor Paving and Wet Areas

OUTDOOR PAVING p. 554

Sizes	Thickness	Surface finish
37,5x75 cm - 14 ³ / ₄ "x29 ¹ / ₂ "	± 9 mm	Grip R11 A+B+C
120x120 cm - 47 ¹ / ₄ "x47 ¹ / ₄ "	± 20 mm	Textured R11 A+B+C
60x60 cm - 23 ⁵ / ₈ "x23 ⁵ / ₈ "	± 20 mm	Textured R11 A+B+C

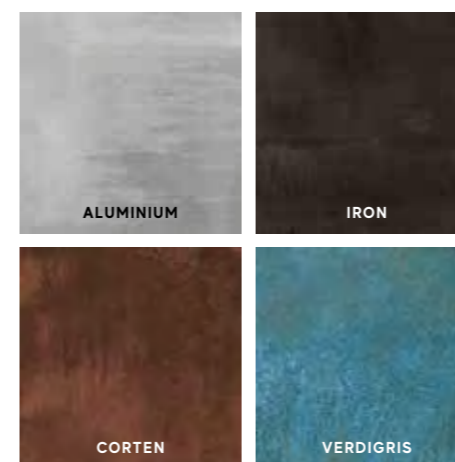

Wall tiles / Rivestimento

WHITEBODY WALL TILES - RECTIFIED MONOCALIBER
RIVESTIMENTI IN PASTA BIANCA - RETTIFICATO MONOCALIBRO

Sizes	Thickness	Surface finish
50x120 cm - 19 ⁵ / ₈ "x47 ¹ / ₄ "	± 8,5 mm	Matte

BLAZE Porcelain Tiles / Gres Porcellanato

MATTE SURFACE / SUPERFICIE MATT



120x278 cm 47¹/₄"x109¹/₂"
 APO7 Blaze Aluminium 120x278
 APO8 Blaze Corten 120x278
 APO9 Blaze Iron 120x278



atlasPLAN p. 500



MATTE / MATT
162x324 cm 63³/₄"x127¹/₂"
 > **NON RECTIFIED / NON RETTIFICATO**
 A3ND Blaze Iron Matt ± 12 mm ST *

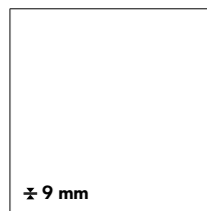

120x120 cm 47¹/₄"x47¹/₄"
 APPK Blaze Aluminium 120x120
 APPW Blaze Corten 120x120
 APPX Blaze Iron 120x120

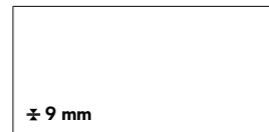

75x150 cm 29¹/₂"x59"
 APNY Blaze Aluminium 75x150
 APNZ Blaze Corten 75x150
 APNØ Blaze Iron 75x150

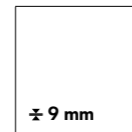

75x75 cm 29¹/₂"x29¹/₂"
 APOU Blaze Aluminium 75x75
 APOV Blaze Corten 75x75
 APOW Blaze Iron 75x75

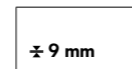

37,5x75 cm 14³/₄"x29¹/₂"
 APOØ Blaze Aluminium 37,5x75
 APO5 Blaze Corten 37,5x75
 APO6 Blaze Iron 37,5x75



POLISHED SURFACE / SUPERFICIE LAPPATA

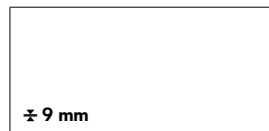

75x150 cm 29¹/₂"x59"
 APOR Blaze Aluminium 75x150 Lapp
 APOS Blaze Corten 75x150 Lapp
 APOT Blaze Iron 75x150 Lapp

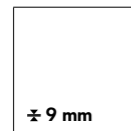

75x75 cm 29¹/₂"x29¹/₂"
 APOX Blaze Aluminium 75x75 Lapp
 APOY Blaze Corten 75x75 Lapp
 APOZ Blaze Iron 75x75 Lapp



GRIP SURFACE / SUPERFICIE GRIP

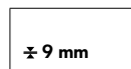

37,5x75 cm 14³/₄"x29¹/₂"
 AØID Blaze Aluminium 37,5x75 Grip
 AØIF Blaze Corten 37,5x75 Grip
 AØIG Blaze Iron 37,5x75 Grip



OUTDOOR PAVING ± 20 mm / PAVIMENTI DA ESTERNO ± 20 mm

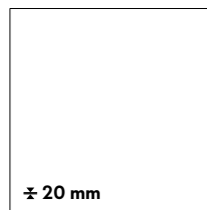

120x120 cm 47¹/₄"x47¹/₄"
 AØ5F Blaze Corten 120x120 20 mm

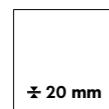

60x60 cm 23³/₈"x23³/₈"
 AØ5G Blaze Corten 60x60 20 mm



MATTE / GRIP



CORTEN

POLISHED



CORTEN

OUTDOOR PAVING ± 20 mm



CORTEN



ALUMINIUM



ALUMINIUM



IRON



IRON

The semi-glossy polished finish is suitable for residential or low-traffic commercial floors, where no anti-slip performance is required. The surface's shine and great ease of cleaning are the result of in-depth studies and technical research aimed at ensuring its durability over time. If the product is in direct contact with the outdoors, moisture and dirt absorption devices must be used to prevent scratching. / La finitura lappata semilucida è indicata per pavimenti residenziali o commerciali poco sollecitati, laddove non siano richieste prestazioni antiscivolo. La lucentezza e l'elevata facilità di pulizia della superficie sono frutto di studi approfonditi e accurate ricerche tecniche volte a garantirne la persistenza nel tempo. Se il prodotto è a diretto contatto con l'esterno, prevedere dei dispositivi di assorbimento dell'umidità e dello sporco per prevenire la formazione di graffi.

POLISHED SURFACE / SUPERFICIE LAPPATA | Surface adouci | Geläppte Oberfläche | Superficie brufido | Полуполированный поверхность

MATTE SURFACE / SUPERFICIE MATT | Surface Mat | Matt Oberfläche | Superficie Mante | Матовая поверхность

GRIP SURFACE / SUPERFICIE GRIP | Surface grip | Grip Oberfläche | Superficie Grip | Grip поверхность

OUTDOOR PAVING / PAVIMENTI DA ESTERNO | Sols d'extérieur | Außenbeläge für Außenbereiche | Pavimentos para exteriores | Уличная плитка

* **WITH FIBERGLASS MESH / VERSIONE STUOIATA** | Version à nattes | Ausführung mit Glasfasermatte | Versión con malla | С упрочнением из стекловолокна

NON RECTIFIED / NON RETTIFICATO | Non rectifié | Nicht rektifiziert | No rectificada | Неректифицированные

BLAZE Porcelain Tiles / Gres Porcellanato

DECOR RANGE / GAMMA DECORI



A0UR Blaze Aluminium
Mosaico 3D Factory
29x29 - 11³/₈"x11³/₈"

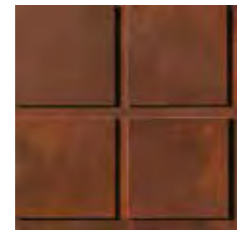

A0US Blaze Corten
Mosaico 3D Factory
29x29 - 11³/₈"x11³/₈"

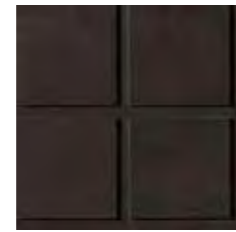

A0UT Blaze Iron
Mosaico 3D Factory
29x29 - 11³/₈"x11³/₈"

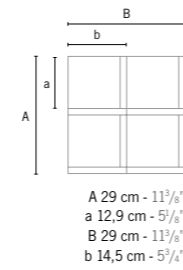

A0UL Blaze Aluminium
Mosaico Esagono Lapp
35,2x30,5 - 13⁷/₈"x12"



A0UM Blaze Corten
Mosaico Esagono Lapp
35,2x30,5 - 13⁷/₈"x12"



A0UN Blaze Iron
Mosaico Esagono Lapp
35,2x30,5 - 13⁷/₈"x12"

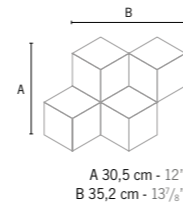

A0UO Blaze Aluminium
Mosaico Esagono Matt
35,2x30,5 - 13⁷/₈"x12"



A0UP Blaze Corten
Mosaico Esagono Matt
35,2x30,5 - 13⁷/₈"x12"



A0UQ Blaze Iron
Mosaico Esagono Matt
35,2x30,5 - 13⁷/₈"x12"



A0UX Blaze Aluminium
Mosaico Matt
30x30 - 11³/₄"x11³/₄"

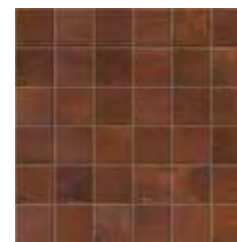

A0UY Blaze Corten
Mosaico Matt
30x30 - 11³/₄"x11³/₄"



A0UZ Blaze Iron
Mosaico Matt
30x30 - 11³/₄"x11³/₄"

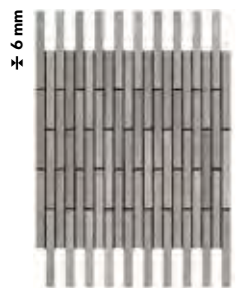
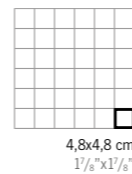

A0UU Blaze Aluminium
Mosaico Twin *♦
36,1x29,4 - 14¹/₄"x11⁵/₈"

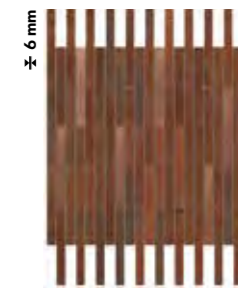

A0UV Blaze Corten
Mosaico Twin *♦
36,1x29,4 - 14¹/₄"x11⁵/₈"



A0UW Blaze Iron
Mosaico Twin *♦
36,1x29,4 - 14¹/₄"x11⁵/₈"

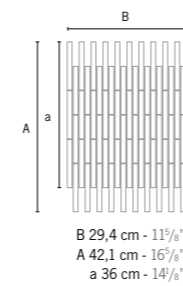

♦ One of the six sheets in the box contains a tile with the Atlas Concorde logo. / Uno dei sei fogli contenuti nella scatola contiene una tessera con logo Atlas Concorde. / Une des six feuilles contenues dans la boîte contient une tesselle décorée du logo Atlas Concorde. / Eines der sechs im Karton enthaltenen Netze enthält einen Mosaikstein mit dem Atlas Concorde-Logo. / Uno dei sei fogli contenuti nella scatola contiene una tessera con logo Atlas Concorde. / En uno de los seis folios que hay dentro de la caja, tiene una tarjeta con el logotipo de Atlas Concorde. / Один из шести листов, помещенных в коробку, содержит табличку с логотипом Atlas Concorde.

* Contains metal. The use of a common mild detergent is recommended. Avoid using acidic or alkaline products, waxes, steel wool, or abrasives. / Parti in metallo. Si consiglia l'utilizzo di un comune detergente neutro. Evitare l'utilizzo di prodotti acidi o alcalini, ceranti e pagliette di metallo o abrasive. / Parties en métal. Nous vous conseillons d'utiliser des détergents neutres courants. Éviter l'utilisation de cires et de produits acides ou alcalins, ainsi que les pailles métalliques ou abrasives. / Metallteile. Es empfiehlt sich, ein haushaltsübliches, neutrales Reinigungsmittel zu verwenden. Saure oder alkalische Produkte, Wachs sowie Stahlwolle- bzw. Scheuerschwämme sind zu vermeiden. / Partes de metal. Recomendamos utilizar un detergente neutro común. Hay que evitar el uso de productos ácidos o alcalinos, ceras y estropajos de metal o abrasivos. / Металлические детали. Рекомендуется чистить обычным нейтральным моющим средством. Не рекомендуется использовать кислотные, щелочные, восковые средства, а также металлические мочалки.

TRIM TILES / PEZZI SPECIALI

p. 568

UPEC p. 595

	Battiscopa		Battiscopa		Gradino *	Scalino *		Scalino *		Scalino Angolare *		Corner ± 6 mm * 1x120 - 3 ¹ / ₈ "x47 ¹ / ₄ "	Corner A.E. ± 6 mm * 1x1 - 3 ¹ / ₈ "x3 ¹ / ₈ "	Battiscopa Sag. Scala		Elemento L Grip *
	Lapp.	Matt.	Lapp.	Matt.		Lapp.	Matt.	Lapp.	Matt.	Lapp.	Matt.			DX *	SX *	
Aluminium	A0IQ	A0IN	A0IK	A0IH	A0IZ	A0JB	A0I8	A0I5	A0I2	A0JH	A0JE	A0UI	A19Y	A0IT	A0IW	A0JK
Corten	A0IR	A0IO	A0IL	A0II	A0I0	A0JC	A0I9	A0I6	A0I3	A0JI	A0JF	A0UJ	A19Z	A0IU	A0IX	A0JL
Iron	A0IS	A0IP	A0IM	A0IJ	A0I1	A0JD	A0JA	A0I7	A0I4	A0JJ	A0JG	A0UK	A190	A0IV	A0IY	A0JM

* THESE PARTS ARE SUPPLIED TO ORDER | I PEZZI SONO DISPONIBILI SU ORDINAZIONE | Les pièces sont disponibles sur commande | Die Teile sind auf Bestellung lieferbar | Las piezas se hacen por encargo | Изготавливаются на заказ



BLAZIE

WALL TILES

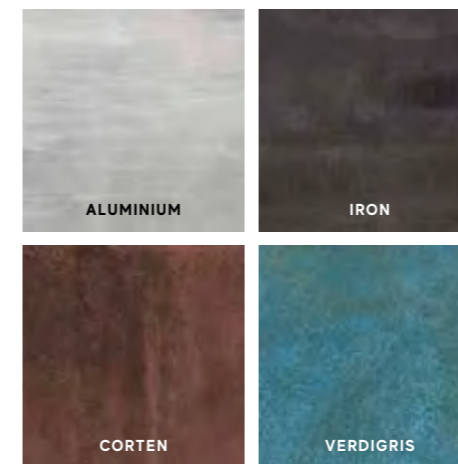

DECORATIVE RANGE / GAMMA DECORATIVA

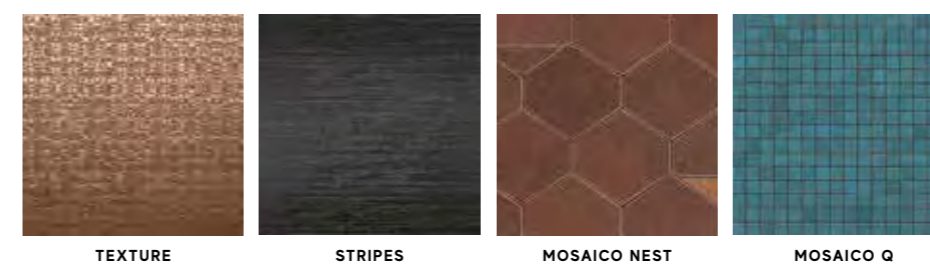

Wall Tiles / Rivestimento

WHITEBODY WALL TILES - RECTIFIED MONOCALIBER
RIVESTIMENTI IN PASTA BIANCA - RETTIFICATO MONOCALIBRO

Sizes	Thickness	Surface finish
50x120 cm - 19 ⁵ / ₈ "x47 ¹ / ₄ "	± 8,5 mm	Matte



WHITEBODY WALL TILES | RIVESTIMENTI IN PASTA BIANCA | Revêtements en pâte blanche | Weißscherbige Wandfliesen | Revestimientos en pasta blanca | Настенная плитка из белой глины
RECTIFIED MONOCALIBER | RETTIFICATO MONOCALIBRO | Rectifié mono-calibre | Geschliffen einkalbrig | Rectificado monocalibré | Ретицированный в одном калибре

BLAZE Wall Tiles / Rivestimento

DECOR RANGE / GAMMA DECORI



A4UC Blaze Aluminium Texture 120 •
50x120 cm - 19⁵/₈"x47¹/₄"

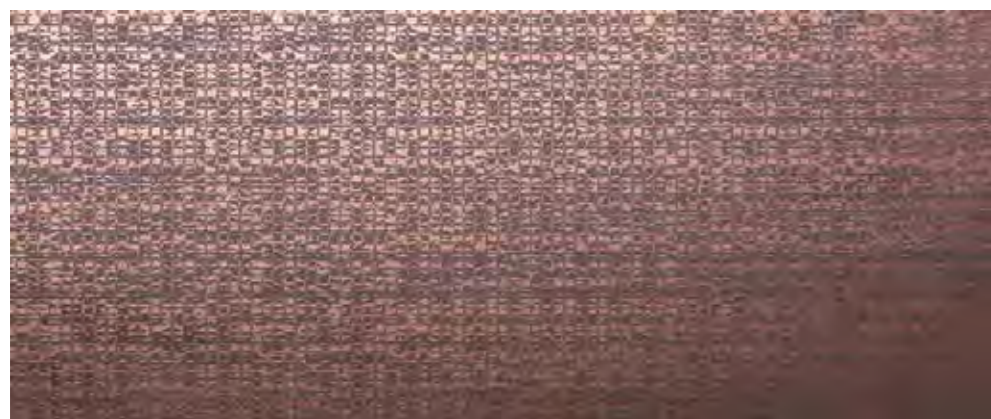

A4UD Blaze Corten Texture 120 •
50x120 cm - 19⁵/₈"x47¹/₄"

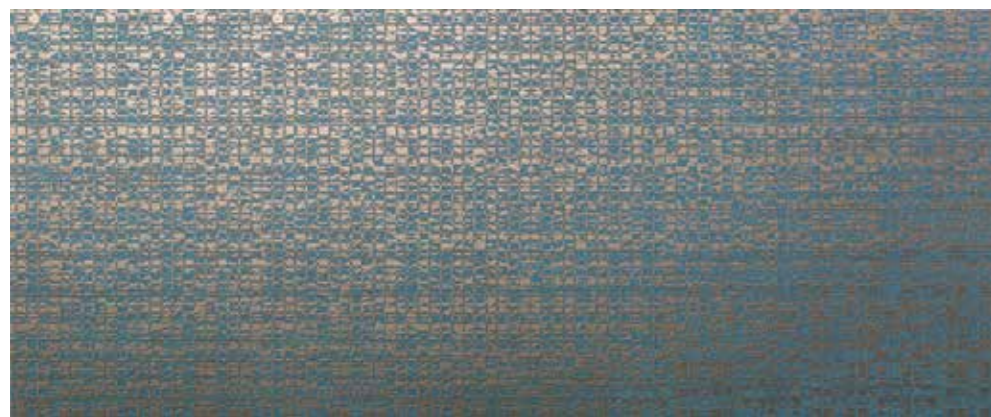

A4UE Blaze Verdigris Texture 120 •
50x120 cm - 19⁵/₈"x47¹/₄"



A4SD Blaze Iron Stripes 50x120 •
50x120 cm - 19⁵/₈"x47¹/₄"



9BNA Blaze Aluminium
Mosaico Nest •
29,4x25,8 - 11⁵/₈"x10¹/₈"



9BNC Blaze Corten
Mosaico Nest •
29,4x25,8 - 11⁵/₈"x10¹/₈"



9BNI Blaze Iron
Mosaico Nest •
29,4x25,8 - 11⁵/₈"x10¹/₈"



9BNV Blaze Verdigris
Mosaico Nest •
29,4x25,8 - 11⁵/₈"x10¹/₈"

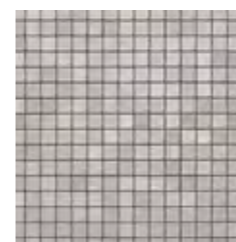

9BQA Blaze Aluminium
Mos Q
30,5x30,5 - 12"x12"



9BQC Blaze Corten
Mos Q
30,5x30,5 - 12"x12"

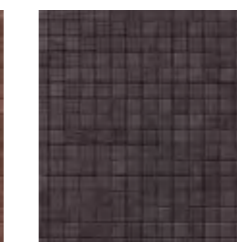

9BQI Blaze Iron
Mos Q
30,5x30,5 - 12"x12"

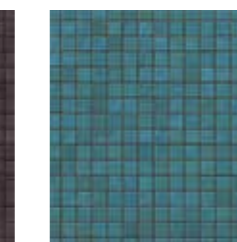

9BQV Blaze Verdigris
Mos Q
30,5x30,5 - 12"x12"

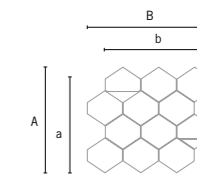

A 29 cm - 11³/₈"
a 25,8 cm - 10¹/₈"
B 34,3 cm - 13³/₈"
b 29,4 cm - 11⁵/₈"

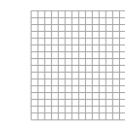

1,7x1,7 cm
2/8"x 2/8"

TRIM TILES / PEZZI SPECIALI

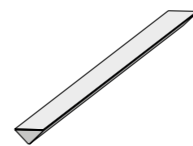

1,4x50 cm - 5/8"x19⁵/₈"
LB5M Blaze Aluminium Corner 50 •
LB5C Blaze Corten Corner 50 •
LB5R Blaze Iron Corner 50 •
LB5V Blaze Verdigris Corner 50 •
LB5S Blaze Iron Stripes Corner 50 •



1,4x1,4 cm - 5/8"x5/8"
A0LA Blaze Aluminium Corner A.E. 1,4 •
A0LC Blaze Corten Corner A.E. 1,4 •
A0LR Blaze Iron Corner A.E. 1,4 •
A0LV Blaze Verdigris Corner A.E. 1,4 •
A0LS Blaze Iron Stripes Corner A.E. 1,4 •

- **Application of decorative materials. The use of a common mild detergent is recommended. Avoid using acidic or alkaline products, waxes, steel wool, or abrasives.** / Applicazione di materie decorative. Si consiglia l'utilizzo di un comune detergente neutro. Evitare l'utilizzo di prodotti acidi o alcalini, ceranti e pagliette di metallo o abrasive. / Application de matériaux décoratifs. Nous conseillons l'emploi de détergents neutres courants. Éviter l'utilisation de cires et de produits acides ou alcalins, ainsi que les pailles métalliques ou abrasives. / Dekorationsmaterial. Es empfiehlt sich, ein haushaltsübliches, neutrales Reinigungsmittel zu verwenden. Saure oder alkalische Produkte, Wachs sowie Stahlwolle- bzw. Scheuerschwämme sind zu vermeiden. / Aplicación de materiales decorativos. Recomendamos utilizar un detergente neutro común. Hay que evitar el uso de productos ácidos o alcalinos, ceras y estropajos de metal o abrasivos. / Применение декоративных материалов. Рекомендуется чистить обычным нейтральным моющим средством. Не рекомендуется использовать кислотные, щелочные, восковые средства, а также металлические мочалки.

• **THESE PARTS ARE SUPPLIED TO ORDER . I PEZZI SONO DISPONIBILI SU ORDINAZIONE**
Les pièces sont disponibles sur commande | Die Teile sind auf Bestellung lieferbar | Las piezas se hacen por encargo | Изготавливаются на заказ



MARVEL

PORCELAIN&WALL TILES

Porcelain Tiles / Gres Porcellanato

COLOURED BODY PORCELAIN TILES - RECTIFIED MONOCALIBER
GRES PORCELLANATO COLORATO IN MASSA - RETTIFICATO MONOCALIBRO

LARGE SIZES p. 500

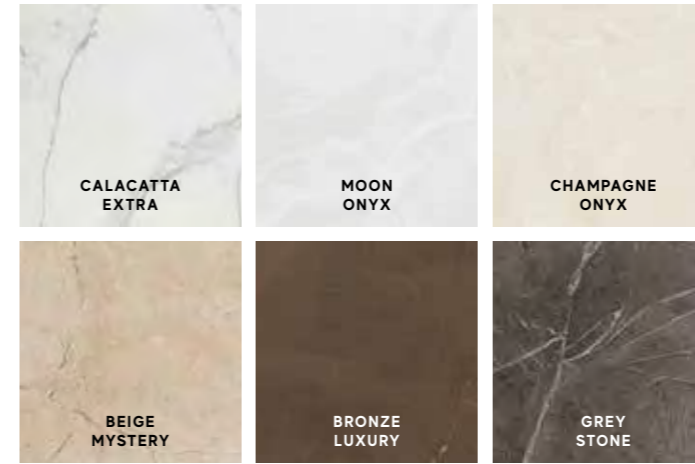

Sizes	Thickness	Surface finish
162x324 cm - 63 ³ / ₄ "x127 ¹ / ₂ " NON RECTIFIED - NON RETTIFICATO	± 6-12-20 mm	Polished Silk
160x320 cm - 63"x126"	± 6 mm	Polished Matte R9 A
160x160 cm - 63"x63"	± 6 mm	Polished Matte R9 A
120x278 cm - 47 ¹ / ₄ "x109 ¹ / ₂ "	± 6 mm	Polished Matte R9 A
120x240 cm - 47 ¹ / ₄ "x94 ¹ / ₂ "	± 9 mm	Polished
120x120 cm - 47 ¹ / ₄ "x47 ¹ / ₄ "	± 9 mm	Polished Matte R9 A
60x120 cm - 23 ⁵ / ₈ "x47 ¹ / ₄ "	± 9 mm	Polished Matte R9 A
75x150 cm - 29 ¹ / ₂ "x59"	± 9 mm	Polished Matte R9 A
75x75 cm - 29 ¹ / ₂ "x29 ¹ / ₂ "	± 9 mm	Polished Matte R9 A
45x90 cm - 17 ³ / ₄ "x35 ³ / ₈ "	± 9 mm	Polished Matte R9 A
60x60 cm - 23 ⁵ / ₈ "x23 ⁵ / ₈ "	± 9 mm	Polished Matte R9 A
30x60 cm - 11 ³ / ₄ "x23 ⁵ / ₈ "	± 9 mm	Polished Matte R9 A

Wall Tiles / Rivestimento

WHITEBODY WALL TILES - RECTIFIED MONOCALIBER
RIVESTIMENTI IN PASTA BIANCA - RETTIFICATO MONOCALIBRO

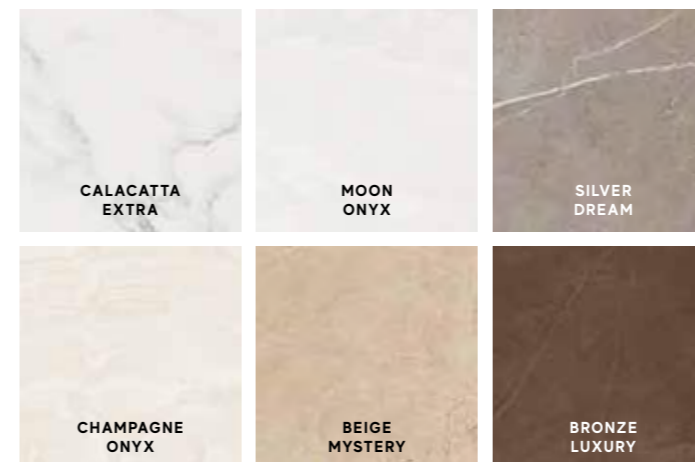

Sizes	Thickness	Surface finish
50x120 cm - 19 ⁵ / ₈ "x47 ¹ / ₄ "	± 8,5 mm	Shiny
40x80 cm - 15 ³ / ₄ "x31 ¹ / ₂ "	± 8,5 mm	Shiny
30,5x91,5 cm - 12"x36"	± 8,5 mm	Shiny
30,5x56 cm - 12"x22"	± 8,5 mm	Shiny
8x31,5 cm - 3 ¹ / ₈ "x12 ³ / ₈ "	± 8,5 mm	Shiny

COLOURED BODY PORCELAIN TILES | GRES PORCELLANATO COLORATO IN MASSA | Grès cérame coloré dans la masse | Durchgefärbtes Feinsteinzeug | Gres porcelánico coloreado en masa | Керамический гранит окрашенный в массе
WHITEBODY WALL TILES | RIVESTIMENTI IN PASTA BIANCA | Revêtements en pâte blanche | Weißscherbige Wandfliesen | Revestimientos en pasta blanca | Настенная плитка из белой глины
RECTIFIED MONOCALIBER | RETTIFICATO MONOCALIBRO | Rectifié mono-calibre | Geschliffen einkalibrig | Rectificado monocalibre | Ретифицированный в одном калибре
NON RECTIFIED | NON RETTIFICATO | Non rectifié | Nicht rektifiziert | No rectificada | Неретифицированные

MARVEL Porcelain Tiles / Gres Porcellanato

POLISHED SURFACE / SUPERFICIE LAPPATA



MARBLE LOOK

MARBLE LOOK



160x320 cm 63"x126"
A05U Marvel Calacatta Extra 160x320RT Lappato

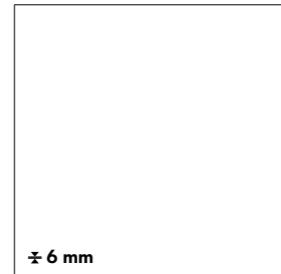

160x160 cm 63"x63"
A051 Marvel Calacatta Extra 160x160RT Lappato



120x278 cm 47¹/₄"x109¹/₂"
A0BM Marvel Calacatta Extra Lappato
A0TJ Marvel Calacatta Extra Bookmatch A Lappato
A0TK Marvel Calacatta Extra Bookmatch B Lappato
A0QD Marvel Grey Stone Lappato
A0UB Marvel Calacatta Extra 120x278 Endless Lappato
A6DU Marvel Calacatta Extra 120x278 Lappato Kit Endless Lp



120x240 cm 47¹/₄"x94¹/₂"
AY2N Marvel Calacatta Extra 120x240 Lappato
AY2O Marvel Grey Stone 120x240 Lappato

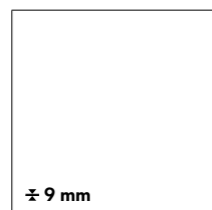

120x120 cm 47¹/₄"x47¹/₄"
AY2R Marvel Calacatta Extra 120x120 Lappato
AY2S Marvel Grey Stone 120x120 Lappato

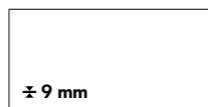

60x120 cm 23⁵/₈"x47¹/₄"
A21S Marvel Calacatta Extra 60x120 Lappato
A21H Marvel Grey Stone 60x120 Lappato



75x150 cm 29¹/₂"x59"
AMSF Marvel Calacatta Extra 75x150 Lappato
A8K4 Marvel Grey Stone 75x150 Lappato
A8K3 Marvel Champagne Onyx 75x150 Lappato

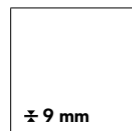

75x75 cm 29¹/₂"x29¹/₂"
ADPV Marvel Calacatta Extra 75 Lappato
ADPX Marvel Moon Onyx 75 Lappato
ADPY Marvel Grey Stone 75 Lappato
ADPW Marvel Champagne Onyx 75 Lappato
ADPT Marvel Beige Mystery 75 Lappato
ADPU Marvel Bronze Luxury 75 Lappato

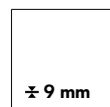

60x60 cm 23⁵/₈"x23⁵/₈"
7N30 Marvel Calacatta Extra 60 Lappato
7N3P Marvel Moon Onyx 60 Lappato
7N3T Marvel Grey Stone 60 Lappato
7N3Q Marvel Champagne Onyx 60 Lappato
7N3R Marvel Beige Mystery 60 Lappato
7N3S Marvel Bronze Luxury 60 Lappato

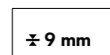

30x60 cm 11³/₄"x23⁵/₈"
D016 Marvel Calacatta Extra 30x60 Lappato
D017 Marvel Moon Onyx 30x60 Lappato
D021 Marvel Grey Stone 30x60 Lappato
D018 Marvel Champagne Onyx 30x60 Lappato
D019 Marvel Beige Mystery 30x60 Lappato
D020 Marvel Bronze Luxury 30x60 Lappato



45x90 cm 17³/₄"x35³/₈"
ADRS Marvel Calacatta Extra 45x90 Lappato
AVWZ Marvel Moon Onyx 45x90 Lappato
ADSY Marvel Grey Stone 45x90 Lappato
AVVY Marvel Champagne Onyx 45x90 Lappato
AVWW Marvel Beige Mystery 45x90 Lappato
AVWX Marvel Bronze Luxury 45x90 Lappato



POLISHED / LAPPATO
162x324 cm 63³/₄"x127¹/₂"
> **NON RECTIFIED / NON RETTIFICATO**
AN1J Calacatta Extra A Polished ± 6 mm ST *
AAVD Calacatta Extra A Polished ± 12 mm ST *
AN1W Calacatta Extra A Polished ± 20 mm
A00I Calacatta Extra B Polished ± 6 mm ST *
AAVF Calacatta Extra B Polished ± 12 mm ST *
A00E Calacatta Extra B Polished ± 20 mm
AOAZ Calacatta Extra A Bookmatch Polished ± 6 mm ST *
AAZX Calacatta Extra A Bookmatch Polished ± 12 mm ST *



CALACATTA EXTRA



CHAMPAGNE ONYX



MOON ONYX

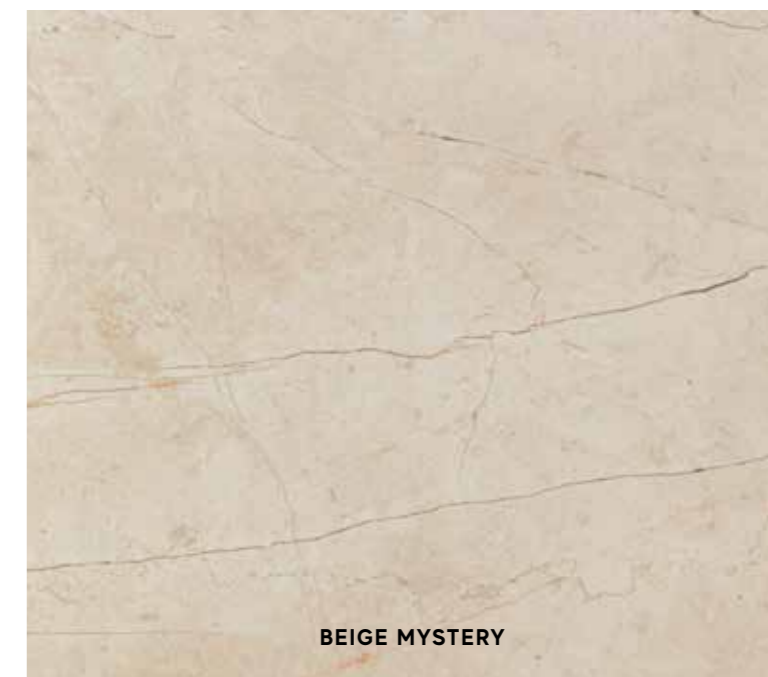

BEIGE MYSTERY

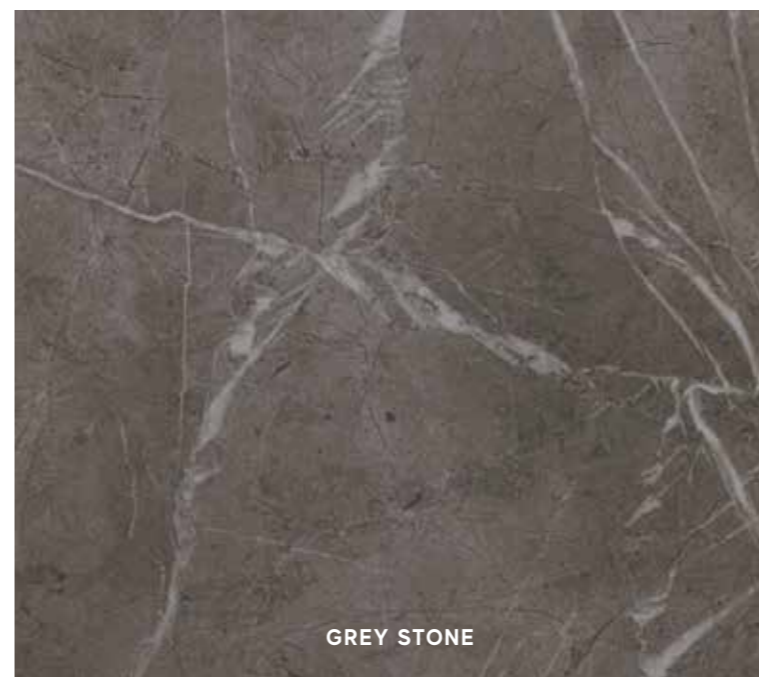

GREY STONE



BRONZE LUXURY

The glossy polished finish is suitable for residential or low-traffic commercial floors, where no anti-slip performance is required, and for walls. The polished glossy surface finish, surprisingly brilliant and bright, features slight irregularities typical of natural marble. The extraordinary brilliance and the easy cleaning of the surface are the result of in-depth research aimed at guaranteeing its durability over time. - If the product is in direct contact with the outdoors, provide devices for absorbing moisture and dirt to prevent scratches. / La finitura lappata lucida è indicata per pavimenti residenziali o commerciali poco sollecitati, laddove non siano richieste prestazioni antiscivolo, e per rivestimenti. La finitura lappata lucida offre una superficie sorprendentemente brillante e specchiante, con lievi irregolarità tipiche dei marmi naturali. La straordinaria lucentezza e l'elevata pulibilità della superficie sono frutto di studi approfonditi e accurate ricerche tecniche volte a garantirne la persistenza nel tempo. - Se il prodotto è a diretto contatto con l'esterno, prevedere dei dispositivi di assorbimento dell'umidità e della sporcizia per prevenire la formazione di graffi.

POLISHED SURFACE / SUPERFICIE LAPPATA | Surface adouci | Geläpft oberfläche | Superficie bruñido | Полиполированный поверхность

* **WITH FIBERGLASS MESH / VERSIONE STUOIATA** | Version à nattes | Ausführung mit Glasfasermatte | Version con maglia | C упрочнением из стекловолоконна
NON RECTIFIED / NON RETTIFICATO | Non rectifié | Nicht rektifiziert | No rectificada | Неретифицированные



V2
SLIGHT
VARIATION

MARVEL Porcelain Tiles / Gres Porcellanato

MATTE SURFACE / SUPERFICIE MATT



160x320 cm 63"x126"
A05Y Marvel Calacatta Extra 160x320RT Matt

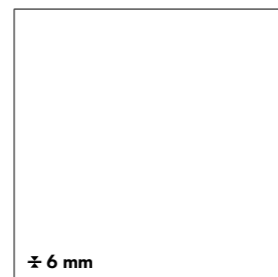

160x160 cm 63"x63"
A054 Marvel Calacatta Extra 160x160RT Matt

atlasPLAN p. 500



SILK
162x324 cm 63³/₄"x127¹/₂"
> **NON RECTIFIED / NON RETTIFICATO**
AN1G Calacatta Extra A Silk ± 6 mm ST *
AA2T Calacatta Extra A Silk ± 12 mm ST *
A0YC Calacatta Extra A Silk ± 20 mm
A28Q Calacatta Extra A Silk NATURA VEIN ± 20 mm
A00K Calacatta Extra B Silk ± 6mm ST *
AA3G Calacatta Extra B Silk ± 12 mm ST *
AOAW Calacatta Extra A Bookmatch Silk ± 6 mm ST *
AMJV Calacatta Extra A Bookmatch Silk ± 12 mm ST *
A0YD Calacatta Extra A Bookmatch Silk ± 20 mm
AN1V Grey Stone Silk ± 6 mm ST *
AAWA Grey Stone Silk ± 12 mm ST *
AN2B Grey Stone Silk ± 20 mm



120x278 cm 47¹/₄"x109¹/₂"
A0BT Marvel Calacatta Extra 120x278 Matt
A2RP Marvel Grey Stone 120x278 Matt

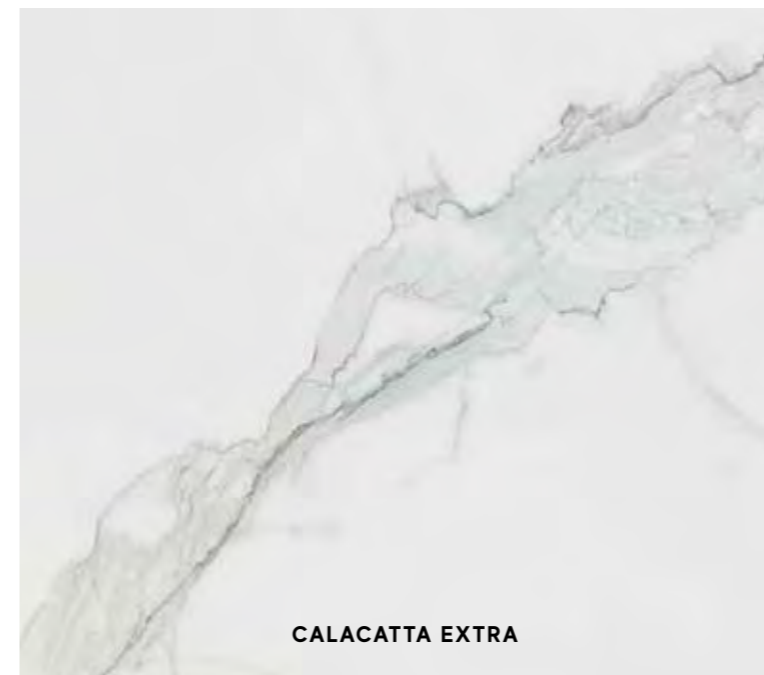

CALACATTA EXTRA



CHAMPAGNE ONYX



MOON ONYX

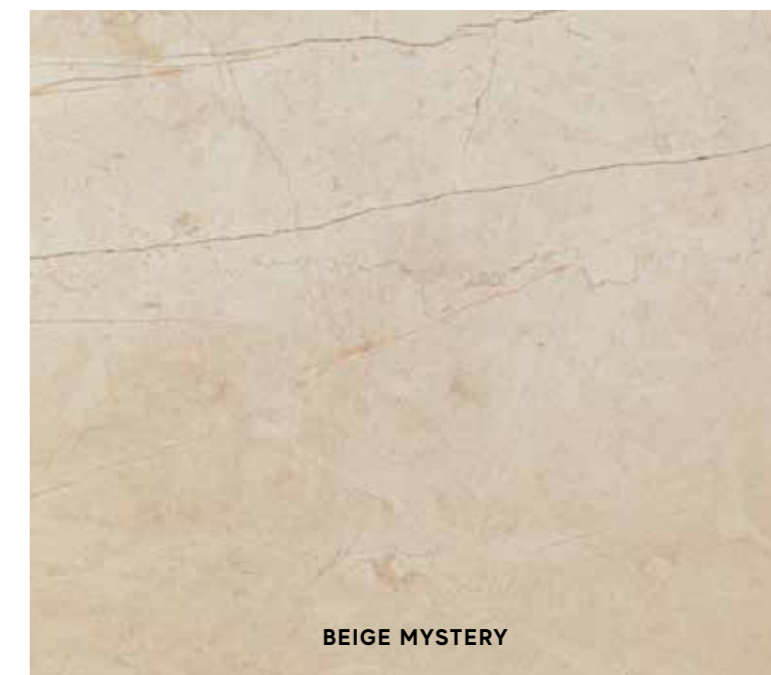

BEIGE MYSTERY

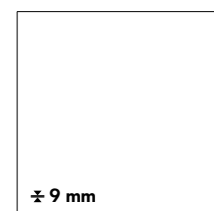

120x120 cm 47¹/₄"x47¹/₄"
A20Y Marvel Calacatta Extra 120x120 Matt
AEQY Marvel Grey Stone 120x120 Matt

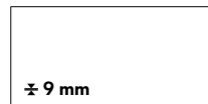

60x120 cm 23³/₈"x47¹/₄"
A208 Marvel Calacatta Extra 60x120 Matt
A209 Marvel Grey Stone 60x120 Matt

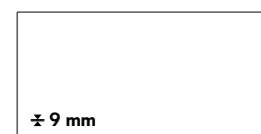

75x150 cm 29¹/₂"x59"
AMGC Marvel Calacatta Extra 75x150

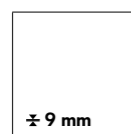

75x75 cm 29¹/₂"x29¹/₂"
ASCE Marvel Calacatta Extra 75
ASCF Marvel Moon Onyx 75
ASCJ Marvel Grey Stone 75
ASCG Marvel Champagne Onyx 75
ASCH Marvel Beige Mystery 75
ASCI Marvel Bronze Luxury 75

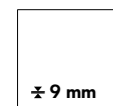

60x60 cm 23³/₈"x23³/₈"
7N3A Marvel Calacatta Extra 60
7N3B Marvel Moon Onyx 60
7N3F Marvel Grey Stone 60
7N3C Marvel Champagne Onyx 60
7N3D Marvel Beige Mystery 60
7N3E Marvel Bronze Luxury 60

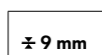

30x60 cm 11³/₄"x23³/₈"
D095 Marvel Calacatta Extra 30x60
D096 Marvel Moon Onyx 30x60
D100 Marvel Grey Stone 30x60
D097 Marvel Champagne Onyx 30x60
D098 Marvel Beige Mystery 30x60
D099 Marvel Bronze Luxury 30x60

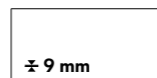

45x90 cm 17³/₄"x35³/₈"
ASFE Marvel Calacatta Extra 45x90
ASFG Marvel Moon Onyx 45x90
ASFJ Marvel Grey Stone 45x90
ASFF Marvel Champagne Onyx 45x90
ASFH Marvel Beige Mystery 45x90
ASFI Marvel Bronze Luxury 45x90

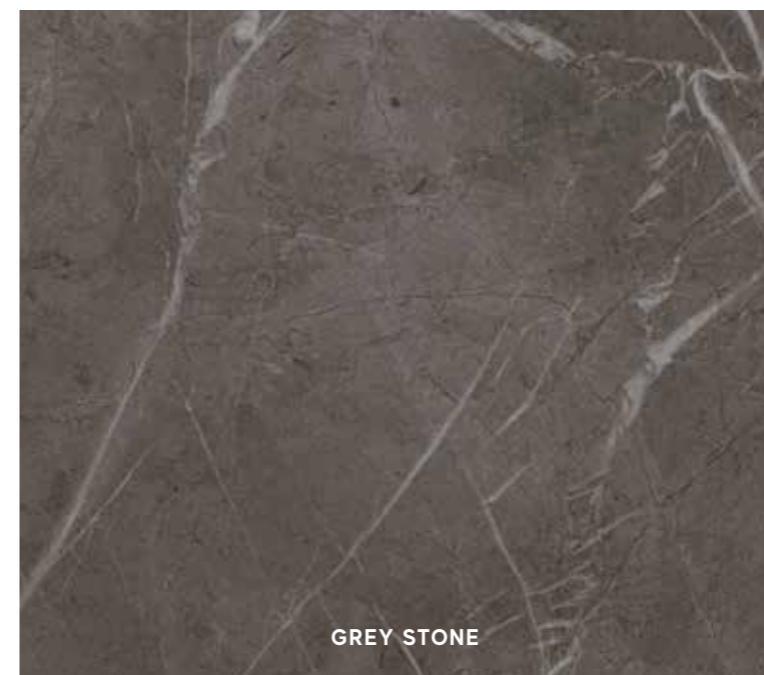

GREY STONE



BRONZE LUXURY



V2
SLIGHT
VARIATION

MATTE SURFACE | SUPERFICIE MATT | Surface Mat | Matt oberfläche | Superficie Mate | Матовая поверхность
* WITH FIBERGLASS MESH | VERSIONE STUOIATA | Version à nattes | Ausführung mit Glasfasermatte | Versión con malla | С упрочнением из стекловолоконка
NON RECTIFIED | NON RETTIFICATO | Non rectifié | Nicht rektifiziert | No rectificada | Нереттифицированные

MARVEL Porcelain Tiles / Gres Porcellanato

DECOR RANGE / GAMMA DECORI



ASLC Marvel Calacatta Mosaico 3D* 30x30 - 11³/₄"x11³/₄"
 ASLD Marvel Moon Mosaico 3D* 30x30 - 11³/₄"x11³/₄"
 ASLH Marvel Grey Mosaico 3D* 30x30 - 11³/₄"x11³/₄"
 ASLE Marvel Champagne Mosaico 3D* 30x30 - 11³/₄"x11³/₄"
 ASLF Marvel Beige Mosaico 3D* 30x30 - 11³/₄"x11³/₄"
 ASLG Marvel Bronze Mosaico 3D* 30x30 - 11³/₄"x11³/₄"



ASK5 Marvel Calacatta Mosaico Matt 30x30 - 11³/₄"x11³/₄"
 ASK6 Marvel Moon Mosaico Matt 30x30 - 11³/₄"x11³/₄"
 ASLA Marvel Grey Mosaico Matt 30x30 - 11³/₄"x11³/₄"
 ASK7 Marvel Champagne Mosaico Matt 30x30 - 11³/₄"x11³/₄"
 ASK8 Marvel Beige Mosaico Matt 30x30 - 11³/₄"x11³/₄"
 ASK9 Marvel Bronze Mosaico Matt 30x30 - 11³/₄"x11³/₄"

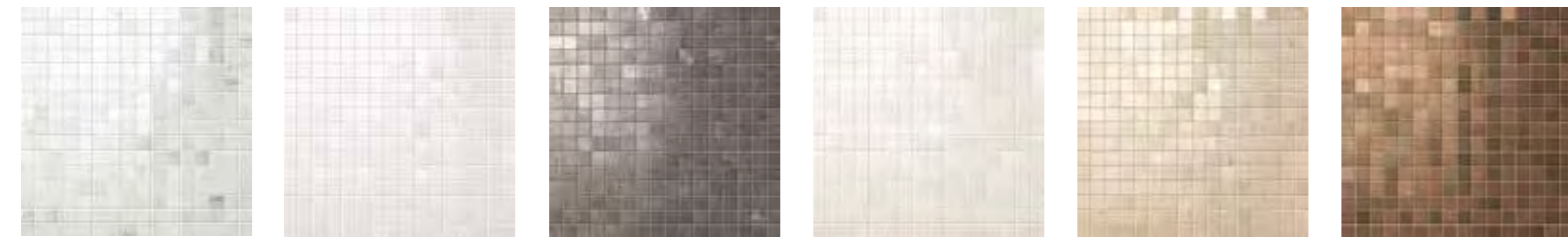

ASMB Marvel Calacatta Mosaico Lappato 30x30 - 11³/₄"x11³/₄"
 ASMC Marvel Moon Mosaico Lappato 30x30 - 11³/₄"x11³/₄"
 ASMG Marvel Grey Mosaico Lappato 30x30 - 11³/₄"x11³/₄"
 ASMD Marvel Champagne Mosaico Lappato 30x30 - 11³/₄"x11³/₄"
 ASME Marvel Beige Mosaico Lappato 30x30 - 11³/₄"x11³/₄"
 ASMF Marvel Bronze Mosaico Lappato 30x30 - 11³/₄"x11³/₄"



ASM9 Marvel Grey/Moon Greca Mosaico 18,5x30 - 7¹/₄"x11³/₄"
 ANSB Marvel Grey/Moon Angolo Mosaico 18,5x18,5 - 7¹/₄"x 7¹/₄"
 ASM8 Marvel Bronze/Champagne Greca Mosaico 18,5x30 - 7¹/₄"x11³/₄"
 ASNA Marvel Bronze/Champagne Angolo Mosaico 18,5x18,5 - 7¹/₄"x 7¹/₄"

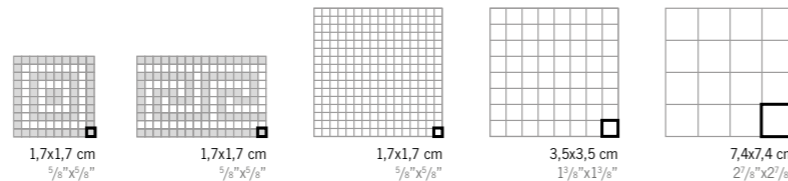

• **MULTI-THICKNESS MOSAIC, CLOSE JOINT INSTALLATION WITHOUT GROUTING.**
 MOSAICO MULTISPESORE, POSA SENZA STUCCATURA A GIUNTO UNITO.
 Mosaïque multi-épaisseur, pose sans mastic avec joint nul.
 Mosaik mit verschiedenen Stärken, fugenlose Verlegung ohne Mörtel.
 Mosaico multiespesor, colocación sin mástique y sin juntas.
 Мозаика разной толщины; укладка встык без затирки швов.

THE DECORATION CAN ONLY BE LAID ON THE WALL | IL DECORO SI PUÒ POSARE SOLO A RIVESTIMENTO
 Décor uniquement mural | Das Dekor kann nur an der Wand verlegt werden | La decoración se puede colocar únicamente en paredes | Декор может быть уложен только на стену.



AVXF Marvel Calacatta Listello 7x75 Lappato
 7x75 - 2³/₄"x29¹/₂"



AVXG Marvel Moon Listello 7x75 Lappato
 7x75 - 2³/₄"x29¹/₂"



AVXK Marvel Grey Listello 7x75 Lappato
 7x75 - 2³/₄"x29¹/₂"



AVXH Marvel Champagne Listello 7x75 Lappato
 7x75 - 2³/₄"x29¹/₂"



AVXJ Marvel Beige Listello 7x75 Lappato
 7x75 - 2³/₄"x29¹/₂"



AVXI Marvel Bronze Listello 7x75 Lappato
 7x75 - 2³/₄"x29¹/₂"



AVXB Marvel Calacatta Listello 7x60 Lappato
 7x60 - 2³/₄"x23⁵/₈"



AVXC Marvel Moon Listello 7x60 Lappato
 7x60 - 2³/₄"x23⁵/₈"



AVXE Marvel Grey Listello 7x60 Lappato
 7x60 - 2³/₄"x23⁵/₈"



AE3W Marvel Champagne Listello 7x60 Lappato
 7x60 - 2³/₄"x23⁵/₈"



AVXD Marvel Beige Listello 7x60 Lappato
 7x60 - 2³/₄"x23⁵/₈"



AE3X Marvel Bronze Listello 7x60 Lappato
 7x60 - 2³/₄"x23⁵/₈"



ASJ3 Marvel Calacatta Angolo 7x7 Lappato
 7x7 - 2³/₄"x2³/₄"



ASJ4 Marvel Moon Angolo 7x7 Lappato
 7x7 - 2³/₄"x2³/₄"



ASJ8 Marvel Grey Angolo 7x7 Lappato
 7x7 - 2³/₄"x2³/₄"



ASJ5 Marvel Champagne Angolo 7x7 Lappato
 7x7 - 2³/₄"x2³/₄"



ASJ6 Marvel Beige Angolo 7x7 Lappato
 7x7 - 2³/₄"x2³/₄"



ASJ7 Marvel Bronze Angolo 7x7 Lappato
 7x7 - 2³/₄"x2³/₄"



AVXL Marvel Calacatta Listello Esagono Lappato
 11x86 - 4³/₈"x33⁷/₈"



AVXM Marvel Champagne Listello Esagono Lappato
 11x86 - 4³/₈"x33⁷/₈"



AVXN Marvel Moon Listello Esagono Lappato
 11x86 - 4³/₈"x33⁷/₈"



AVXO Marvel Beige Listello Esagono Lappato
 11x86 - 4³/₈"x33⁷/₈"



AVXQ Marvel Grey Listello Esagono Lappato
 11x86 - 4³/₈"x33⁷/₈"



AVXP Marvel Bronze Listello Esagono Lappato
 11x86 - 4³/₈"x33⁷/₈"



AD5Q Etic Rovere Listello Esagono
 11x86 - 4³/₈"x33⁷/₈"



AD5P Etic Rovere Bianco Listello Esagono
 11x86 - 4³/₈"x33⁷/₈"



AD5R Etic Noce Listello Esagono
 11x86 - 4³/₈"x33⁷/₈"



AD5S Etic Ebano Listello Esagono
 11x86 - 4³/₈"x33⁷/₈"



AD3J Etic Listello Palissandro Esagono
 11x86 - 4³/₈"x33⁷/₈"

MARBLE LOOK

MARBLE LOOK

MARVEL Porcelain Tiles / Gres Porcellanato

DECOR RANGE / GAMMA DECORI

MARBLE LOOK

MARBLE LOOK



ASL5 Marvel Calacatta Cassettoni Lappato
45x45 - 17³/₄"x17³/₄"

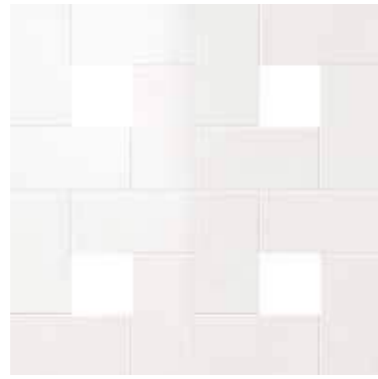

ASL6 Marvel Moon Cassettoni Lappato
45x45 - 17³/₄"x17³/₄"



ASMA Marvel Grey Cassettoni Lappato
45x45 - 17³/₄"x17³/₄"

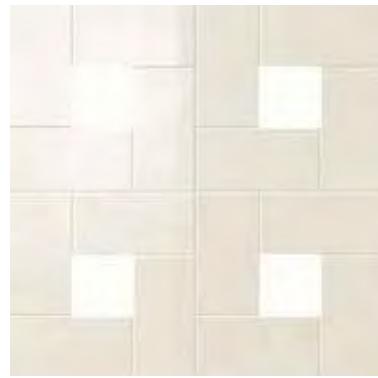

ASL7 Marvel Champagne Cassettoni Lappato
45x45 - 17³/₄"x17³/₄"



ASL8 Marvel Beige Cassettoni Lappato
45x45 - 17³/₄"x17³/₄"



ASL9 Marvel Bronze Cassettoni Lappato
45x45 - 17³/₄"x17³/₄"



ASJ3 Marvel Calacatta Angolo 7x7 Lappato
7x7 - 2³/₄"x2³/₄"



ASJ4 Marvel Moon Angolo 7x7 Lappato
7x7 - 2³/₄"x2³/₄"



ASJ8 Marvel Grey Angolo 7x7 Lappato
7x7 - 2³/₄"x2³/₄"



ASJ5 Marvel Champagne Angolo 7x7 Lappato
7x7 - 2³/₄"x2³/₄"



ASJ6 Marvel Beige Angolo 7x7 Lappato
7x7 - 2³/₄"x2³/₄"



ASJ7 Marvel Bronze Angolo 7x7 Lappato
7x7 - 2³/₄"x2³/₄"

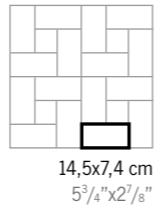

ADQ2 Marvel Statuario Select Angolo 7x7 Lappato
7x7 - 2³/₄"x2³/₄"



ADQ6 Marvel Grey Fleury Angolo 7x7 Lappato
7x7 - 2³/₄"x2³/₄"



ADQ7 Marvel Noir St. Laurent Angolo 7x7 Lappato
7x7 - 2³/₄"x2³/₄"



ADQ4 Marvel Crema Delicato Angolo 7x7 Lappato
7x7 - 2³/₄"x2³/₄"



ADQ3 Marvel Travertino Alabastrino Angolo 7x7 Lappato
7x7 - 2³/₄"x2³/₄"



ADQ5 Marvel Travertino Silver Angolo 7x7 Lappato
7x7 - 2³/₄"x2³/₄"



AM8R Etic Rovere Bottone 7x7
7x7 - 2³/₄"x2³/₄"



AM8T Etic Noce Bottone 7x7
7x7 - 2³/₄"x2³/₄"



AM8V Etic Palissandro Bottone 7x7
7x7 - 2³/₄"x2³/₄"



AM8S Etic Ulivo Bottone 7x7
7x7 - 2³/₄"x2³/₄"



AM8Q Etic Rovere Bianco Bottone 7x7
7x7 - 2³/₄"x2³/₄"



AM8U Etic Rovere Grigio Bottone 7x7
7x7 - 2³/₄"x2³/₄"



AM8W Etic Ebano Bottone 7x7
7x7 - 2³/₄"x2³/₄"



AVW7 Marvel Glitter Rosone Angolo **
60x60 - 23³/₈"x23³/₈"



AVW4 Marvel Elegance Angolo Warm *
60x60 - 23³/₈"x23³/₈"



AVW6 Marvel Elegance Fascia Warm
60x60 - 23³/₈"x23³/₈"



AVW8 Marvel Glitter Fascia 7x60
7x60 - 2³/₄"x23³/₈"



ASNQ Marvel Glitter Bottone 7x7
7x7 - 2³/₄"x2³/₄"

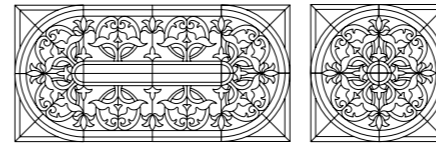

Elegance Warm
Bronze + Beige + Champagne + Calacatta

Elegance Cold
Grey + Calacatta + Moon + Beige

* **MINIMUM ORDER 2 PEZZI.**
ORDINE MINIMO 2 PEZZI.
Commande minimum 2 pièces.
Mindestbestellmenge 2 Stück.
Pedido mínimo 2 unidades.
Минимальный заказ – 2 шт.

** **MINIMUM ORDER 4 PEZZI.**
ORDINE MINIMO 4 PEZZI.
Commande minimum 4 pièces.
Mindestbestellmenge 4 Stück.
Pedido mínimo 4 unidades.
Минимальный заказ – 4 шт.

TRIM TILES / PEZZI SPECIALI

p. 568

	Battiscopa		Gradino *	Scalino *		Scalino *	Scalino Angolare *	Battiscopa Sag. Scala	
	7,2x60 2 ⁷ / ₈ "x23 ³ / ₈ "	7,2x60 2 ⁷ / ₈ "x23 ³ / ₈ "		30x60 11 ³ / ₄ "x23 ³ / ₈ "	33x90 13"x35 ³ / ₈ "			33x75 13"x29 ¹ / ₂ "	33x60 13"x23 ³ / ₈ "
Calacatta Extra	ASLJ	AVXS	ASLQ	ASMH	ASMZ	ASMN	ASMT	ASNC	ASNI
Moon Onyx	ASLK	AVXT	ASLR	ASMI	ASMØ	ASMO	ASMU	ASND	ASNJ
Champagne Onyx	ASLL	AVXU	ASLS	ASMJ	ASM1	ASMP	ASMV	ASNE	ASNK
Beige Mystery	ASLM	AVXV	ASLT	ASMK	ASM2	ASMQ	ASMW	ASNF	ASNL
Bronze Luxury	ASLN	AVXW	ASLU	ASML	ASM5	ASMR	ASMX	ASNG	ASNM
Grey Stone	ASLO	AVXX	ASLV	ASMM	ASM7	ASMS	ASMY	ASNH	ASNN

UPEC p. 595

* THESE PARTS ARE SUPPLIED TO ORDER | I PEZZI SONO DISPONIBILI SU ORDINAZIONE | Les pièces sont disponibles sur commande | Die Teile sind auf Bestellung lieferbar | Las piezas se hacen por encargo | Изготавливаются на заказ

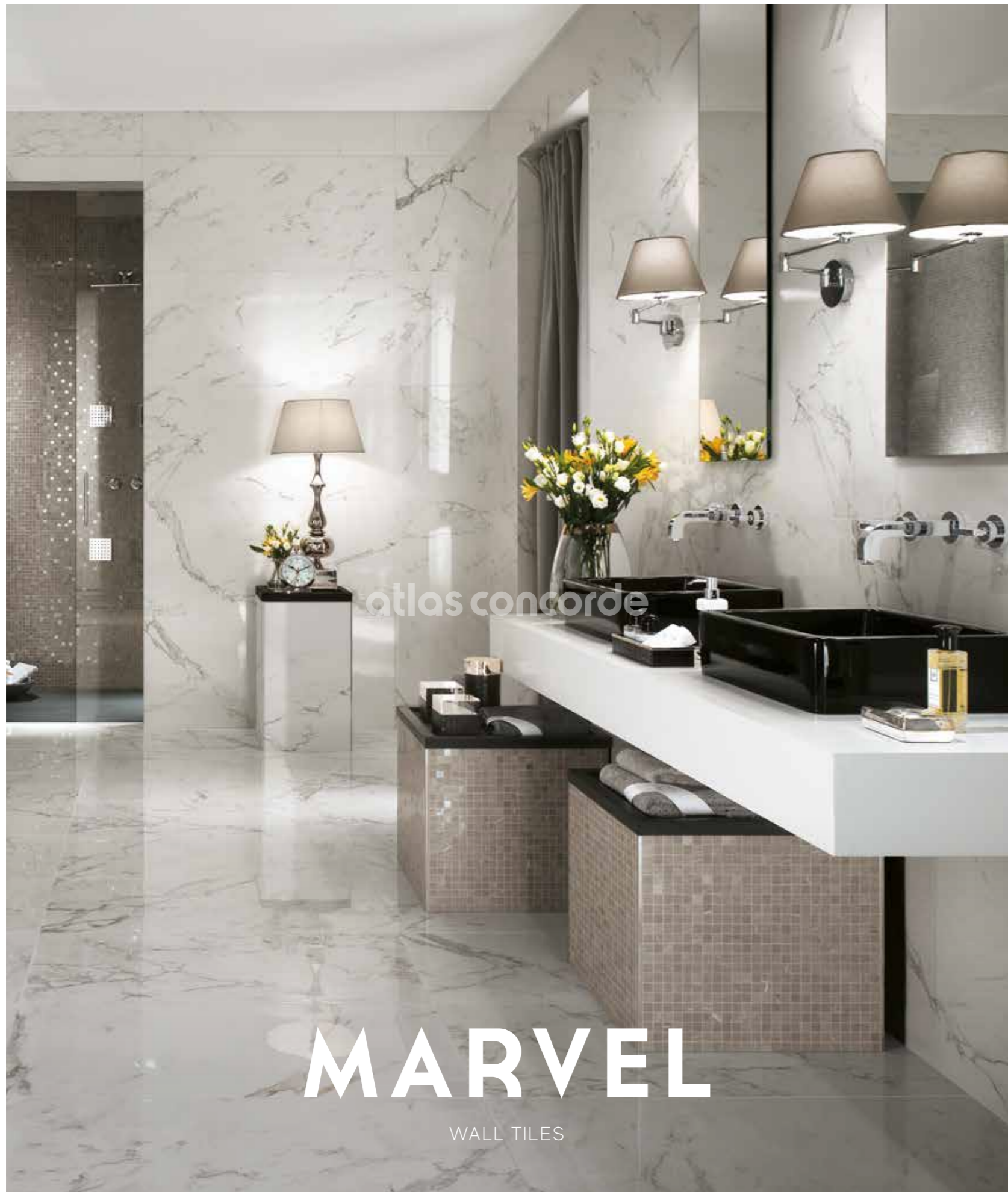

MARVEL

WALL TILES

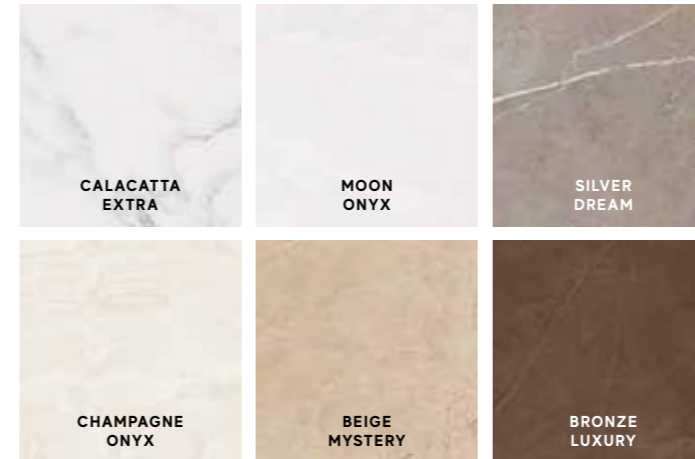

Wall Tiles / Rivestimento

WHITEBODY WALL TILES - RECTIFIED MONOCALIBER
RIVESTIMENTI IN PASTA BIANCA - RETTIFICATO MONOCALIBRO

Sizes	Thickness	Surface finish
50x120 cm - 19 ⁵ / ₈ "x47 ¹ / ₄ "	± 8,5 mm	Shiny
40x80 cm - 15 ³ / ₄ "x31 ¹ / ₂ "	± 8,5 mm	Shiny
30,5x91,5 cm - 12"x36"	± 8,5 mm	Shiny
30,5x56 cm - 12"x22"	± 8,5 mm	Shiny
8x31,5 cm - 3 ¹ / ₈ "x12 ³ / ₈ "	± 8,5 mm	Shiny

DECORATIVE RANGE / GAMMA DECORATIVA



MARVEL Wall Tiles / Rivestimento

SHINY SURFACE / SUPERFICIE LUCIDA



MARBLE LOOK

WALL TILES



A4ST Marvel Calacatta Extra 50x120
50x120 - 19⁷/₈"x47¹/₄"

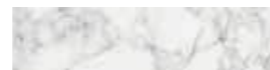

LMKC Marvel Calacatta Extra Brick
8x31,5 - 3¹/₈"x12³/₈"

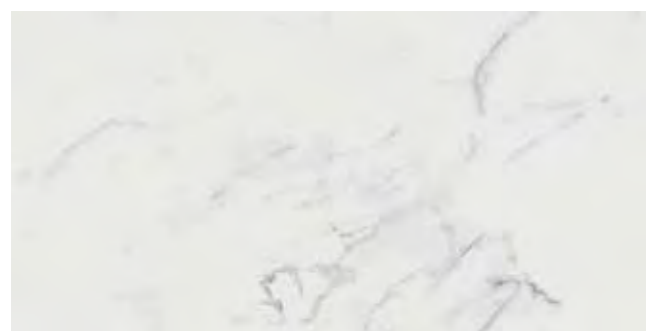

8MVA Marvel Calacatta Extra 40x80
40x80 - 15³/₄"x31¹/₂"



8MVC Marvel Champagne Onyx 40x80
40x80 - 15³/₄"x31¹/₂"



8MVS Marvel Silver Dream 40x80
40x80 - 15³/₄"x31¹/₂"



AR5J Marvel Calacatta Extra 30,5x91,5
30,5x91,5 - 12"x36"



AR5L Marvel Moon Onyx 30,5x91,5
30,5x91,5 - 12"x36"



AR5N Marvel Silver Dream 30,5x91,5
30,5x91,5 - 12"x36"



AR5K Marvel Champagne Onyx 30,5x91,5
30,5x91,5 - 12"x36"



AR5M Marvel Beige Mystery 30,5x91,5
30,5x91,5 - 12"x36"



AR5O Marvel Bronze Luxury 30,5x91,5
30,5x91,5 - 12"x36"

MARBLE LOOK

WALL TILES



V2
SLIGHT
VARIATION



V2
SLIGHT
VARIATION

MARVEL Wall Tiles / Rivestimento

SHINY SURFACE / SUPERFICIE LUCIDA

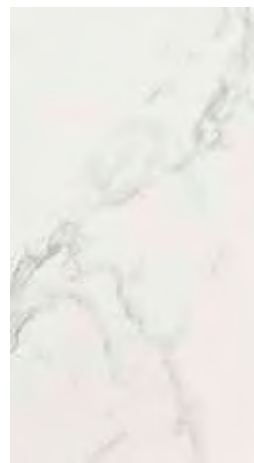

9P5L Marvel Calacatta Extra 30,5x56
30,5x56 - 12"x22"



9P5M Marvel Moon Onyx 30,5x56
30,5x56 - 12"x22"

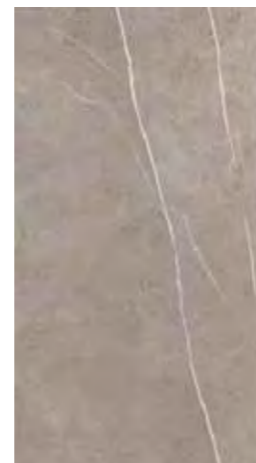

9P5S Marvel Silver Dream 30,5x56
30,5x56 - 12"x22"

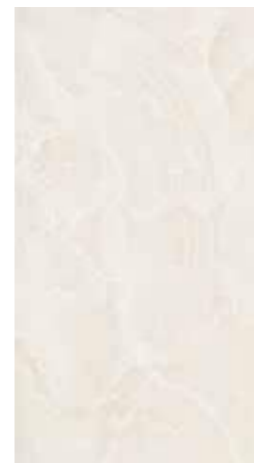

9P5H Marvel Champagne Onyx 30,5x56
30,5x56 - 12"x22"



9P5E Marvel Beige Mystery 30,5x56
30,5x56 - 12"x22"



9P5O Marvel Bronze Luxury 30,5x56
30,5x56 - 12"x22"

TRIM TILES / PEZZI SPECIALI



ASDZ Marvel Calacatta London
5x30,5 - 2"x12"



ASD7 Marvel London A.E.
5x2,5 - 2"x1"



ASD1 Marvel Moon London
5x30,5 - 2"x12"



ASD9 Marvel London A.E.
5x2,5 - 2"x1"



ASD4 Marvel Silver London
5x30,5 - 2"x12"



ASEC Marvel London A.E.
5x2,5 - 2"x1"

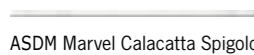

ASDM Marvel Calacatta Spigolo
0,85x30,5 - 3/8"x12"



ASEE Marvel Spigolo A.E.
0,85x0,85 - 3/8"x3/8"

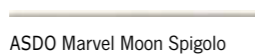

ASDO Marvel Moon Spigolo
0,85x30,5 - 3/8"x12"



ASEG Marvel Spigolo A.E.
0,85x0,85 - 3/8"x3/8"



ASDQ Marvel Silver Spigolo
0,85x30,5 - 3/8"x12"



ASEI Marvel Spigolo A.E.
0,85x0,85 - 3/8"x3/8"



ASDG Marvel Calacatta Alzata
20x30,5 - 7/8"x12"



ASDT Marvel Alzata A.E.
1,5x20 - 5/8"x7/8"



ASDH Marvel Moon Alzata
20x30,5 - 7/8"x12"



ASDV Marvel Alzata A.E.
1,5x20 - 5/8"x7/8"



ASDK Marvel Silver Alzata
20x30,5 - 7/8"x12"



ASDX Marvel Alzata A.E.
1,5x20 - 5/8"x7/8"



ASDØ Marvel Champagne London
5x30,5 - 2"x12"



ASD8 Marvel London A.E.
5x2,5 - 2"x1"



ASD3 Marvel Beige London
5x30,5 - 2"x12"



ASEA Marvel London A.E.
5x2,5 - 2"x1"



ASD5 Marvel Bronze London
5x30,5 - 2"x12"



ASED Marvel London A.E.
5x2,5 - 2"x1"

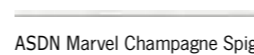

ASDN Marvel Champagne Spigolo
0,85x30,5 - 3/8"x12"



ASEF Marvel Spigolo A.E.
0,85x0,85 - 3/8"x3/8"



ASDP Marvel Beige Spigolo
0,85x30,5 - 3/8"x12"



ASEH Marvel Spigolo A.E.
0,85x0,85 - 3/8"x3/8"



ASDR Marvel Bronze Spigolo
0,85x30,5 - 3/8"x12"



ASEJ Marvel Spigolo A.E.
0,85x0,85 - 3/8"x3/8"



ASDF Marvel Champagne Alzata
20x30,5 - 7/8"x12"



ASDU Marvel Alzata A.E.
1,5x20 - 5/8"x7/8"



ASDJ Marvel Beige Alzata
20x30,5 - 7/8"x12"



ASDW Marvel Alzata A.E.
1,5x20 - 5/8"x7/8"



ASDL Marvel Bronze Alzata
20x30,5 - 7/8"x12"



ASDY Marvel Alzata A.E.
1,5x20 - 5/8"x7/8"



V2
SLIGHT
VARIATION



V2
SLIGHT
VARIATION

MARVEL Wall Tiles / Rivestimento

DECOR RANGE / GAMMA DECORI

MARBLE LOOK

WALL TILES

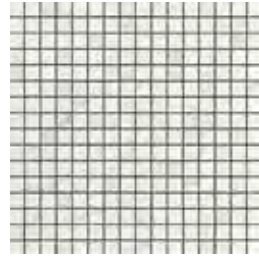

ASCM Marvel Calacatta Mosaic ✓
30,5x30,5 - 12"x12"

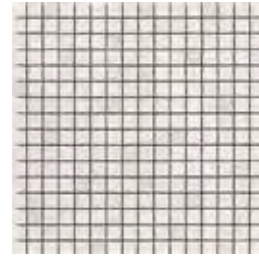

ASCO Marvel Moon Mosaic ✓
30,5x30,5 - 12"x12"

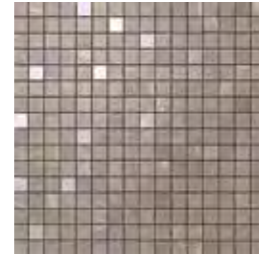

ASCR Marvel Silver Mosaic ✓
30,5x30,5 - 12"x12"

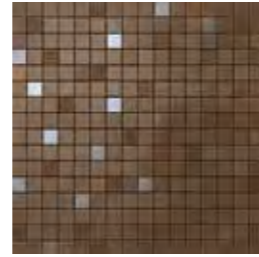

ASCT Marvel Bronze Gold Mosaic ✓ •
30,5x30,5 - 12"x12"

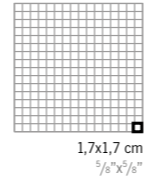

• **DECOR WITH GOLD INSERT.**
DECORO CON INSERTO IN ORO.
Décor avec insert en OR.
Dekor mit Einlage GOLD.
Decoración con aplicación de ORO.
Декор с ЗОЛОТОЙ вставкой.

✓ **MATCHING WITH BOTH SIZES 30.5X91.5 AND 30.5X56.**
ABBINABILI A ENTRAMBI I FORMATI 30,5X91,5 E 30,5X56.
Combinables avec les deux formats 30,5x91,5 et 30,5x56.
Kombinierbar mit den beiden Formaten 30,5x91,5 und 30,5x56.
Combinables con ambos formatos 30,5x91,5 y 30,5x56.
Сочетается с обоими форматами: 30,5x91,5 и 30,5x56.

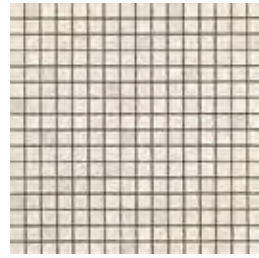

ASCN Marvel Champagne Mosaic ✓
30,5x30,5 - 12"x12"



ASCQ Marvel Beige Mosaic ✓
30,5x30,5 - 12"x12"

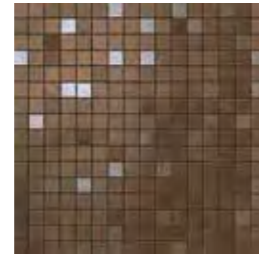

ASCS Marvel Bronze Mosaic ✓
30,5x30,5 - 12"x12"



ASCV Marvel Silver Net Mosaic ✓
30,5x30,5 - 12"x12"



ASCX Marvel Beige Net Mosaic ✓
30,5x30,5 - 12"x12"



ASCW Marvel Bronze Net Mosaic ✓
30,5x30,5 - 12"x12"

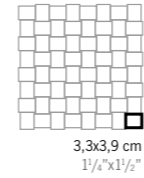

• **ALSO MATCHING WITH CALACATTA EXTRA.**
ABBINABILE ANCHE AL CALACATTA EXTRA.
Combinable également avec Calacatta Extra.
Kombinierbar auch mit Calacatta Extra.
Combinable también con Calacatta Extra.
Сочетается также с Calacatta Extra.

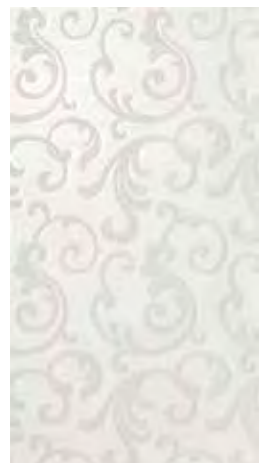

ASC1 Marvel Moon Damask •
30,5x56 - 12"x22"

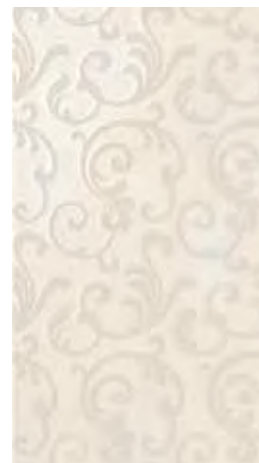

ASCØ Marvel Champagne Damask
30,5x56 - 12"x22"



ASC4 Marvel Silver Stripe
30,5x56 - 12"x22"



ASC3 Marvel Beige Stripe
30,5x56 - 12"x22"



ASCC Marvel Moon Line
30,5x91,5 - 12"x36"



ASCA Marvel Champagne Line
30,5x91,5 - 12"x36"



ASEN Marvel Champagne Wave
30,5x91,5 - 12"x36"



ASCZ Marvel Beige Brocade
30,5x91,5 - 12"x36"



ASCY Marvel Bronze Brocade
30,5x91,5 - 12"x36"

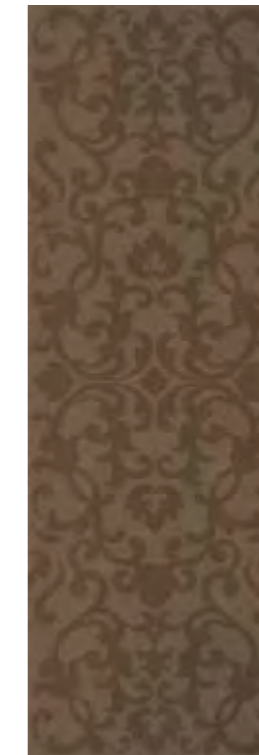

ASCD Marvel Bronze Wallpaper
30,5x91,5 - 12"x36"



ASDC Marvel Calacatta Terminale Lesena
10x20 - 3 7/8" x 7 7/8"



ASC9 Marvel Champagne Terminale Lesena
10x20 - 3 7/8" x 7 7/8"



ASC6 Marvel Calacatta Lesena
30,5x20 - 12" x 7 7/8"



ASC5 Marvel Champagne Lesena
30,5x20 - 12" x 7 7/8"



ASC8 Marvel Calacatta Base Lesena
20x20 - 7 7/8" x 7 7/8"



ASC7 Marvel Champagne Base Lesena
20x20 - 7 7/8" x 7 7/8"



ASDE Marvel Calacatta Fregio
10x30,5 - 3 7/8" x 12"



ASDD Marvel Champagne Fregio
10x30,5 - 3 7/8" x 12"

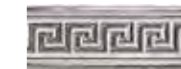

ASEK Marvel Greca Gold •
7,8x30,5 - 3 1/8" x 12"



ASEM Marvel Greca A.E. •
7,8x1,2 - 3 1/8" x 1/2"

• **Decor with GOLD insert.**
Decoro con inserto in ORO.
Décor avec insert en OR.
Dekor mit Einlage GOLD.
Decoración con aplicación de ORO.
Декор с ЗОЛОТОЙ вставкой.

MARBLE LOOK

WALL TILES

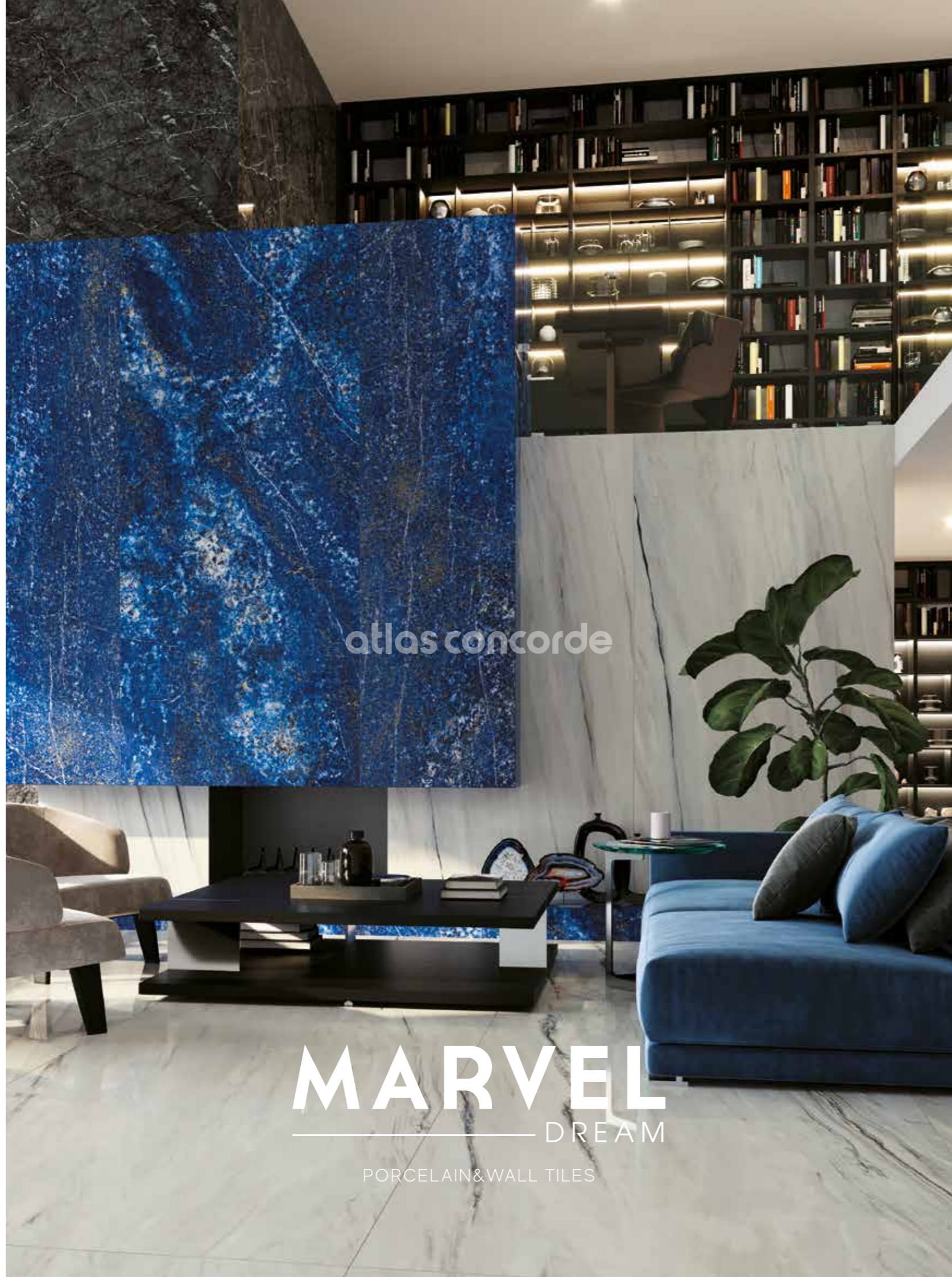

MARVEL
DREAM
PORCELAIN&WALL TILES

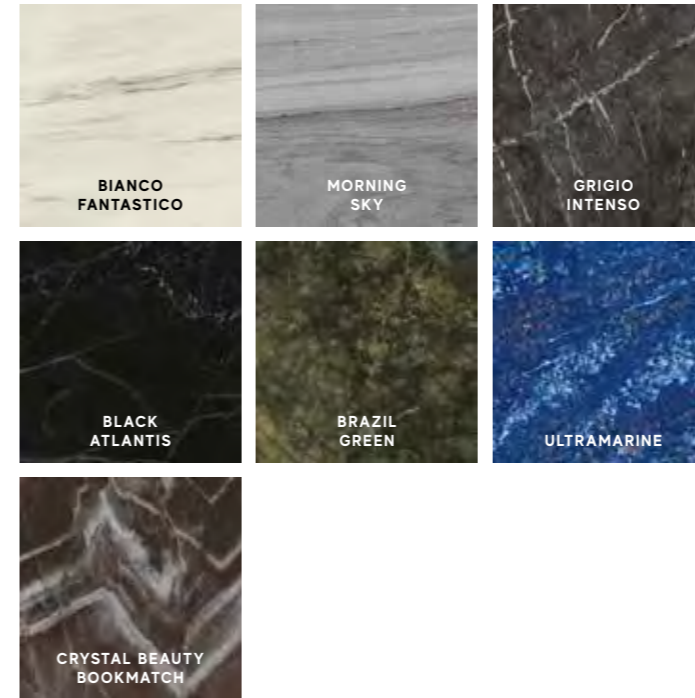

Porcelain tiles / Gres Porcellanato

COLOURED BODY PORCELAIN TILES - RECTIFIED MONOCALIBER
GRES PORCELLANATO COLORATO IN MASSA - RETTIFICATO MONOCALIBRO

LARGE SIZES p. 500

Sizes	Thickness	Surface finish
162x324 cm - 63 ³ / ₄ "x127 ¹ / ₂ " * NON RECTIFIED - NON RETTIFICATO	± 6-12 mm	Polished Silk
120x278 cm - 47 ¹ / ₄ "x109 ¹ / ₂ "	± 6 mm	Polished Matte R9 A
120x240 cm - 47 ¹ / ₄ "x94 ¹ / ₂ "	± 9 mm	Polished
120x120 cm - 47 ¹ / ₄ "x47 ¹ / ₄ "	± 9 mm	Polished Matte R9 A
60x120 cm - 23 ⁵ / ₈ "x47 ¹ / ₄ "	± 9 mm	Polished Matte R9 A
75x150 cm - 29 ¹ / ₂ "x59"	± 9 mm	Polished Matte R9 A
75x75 cm - 29 ¹ / ₂ "x29 ¹ / ₂ "	± 9 mm	Polished Matte R9 A
37,5x75 cm - 14 ³ / ₄ "x29 ¹ / ₂ "	± 9 mm	Polished Matte R9 A
60x60 cm - 23 ⁵ / ₈ "x23 ⁵ / ₈ "	± 9 mm	Polished Matte R10 A+B SOFT TOUCH **

** On demand - Minimum order quantities must be met

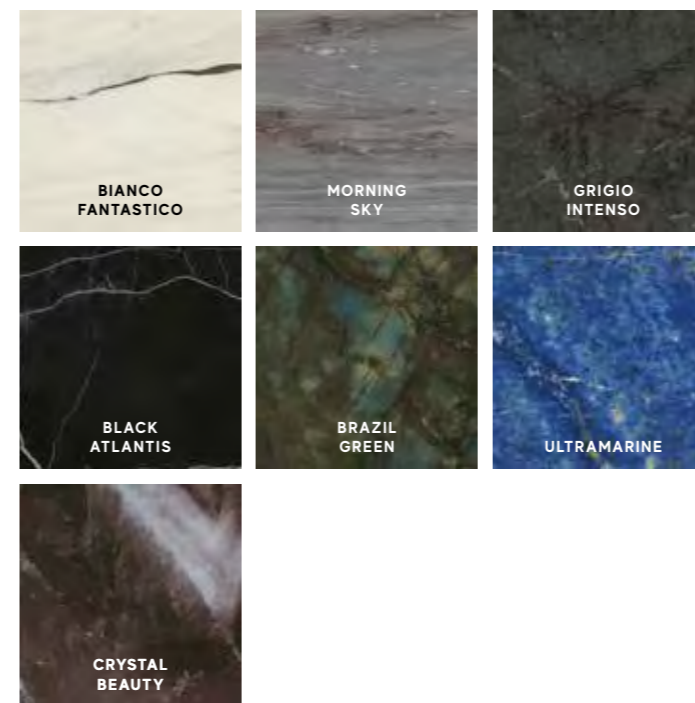

Wall tiles / Rivestimento

WHITEBODY WALL TILES - RECTIFIED MONOCALIBER
RIVESTIMENTI IN PASTA BIANCA - RETTIFICATO MONOCALIBRO

Sizes	Thickness	Surface finish
50x120 cm - 19 ⁵ / ₈ "x47 ¹ / ₄ "	± 8,5 mm	Shiny

COLOURED BODY PORCELAIN TILES | GRES PORCELLANATO COLORATO IN MASSA | Grés cérame coloré dans la masse | Durchgefärbtes Feinsteinzeug | Gres porcelánico coloreado en masa | Керамический гранит окрашенный в массе
WHITEBODY WALL TILES | RIVESTIMENTI IN PASTA BIANCA | Revêtements en pâte blanche | Weißscherbige Wandfliesen | Revestimientos en pasta blanca | Настенная плитка из белой глины
RECTIFIED MONOCALIBER | RETTIFICATO MONOCALIBRO | Rectifié mono-calibre | Geschliffen einkalibrig | Rectificado monocalibre | Ретифицированный в одном калибре
NON RECTIFIED | NON RETTIFICATO | Non rectifié | Nicht rektifiziert | No rectificada | Неретифицированные

MARVEL DREAM Porcelain Tiles / Gres Porcellanato

POLISHED SURFACE / SUPERFICIE LAPPATA



atlasPLAN p. 500



POLISHED / LAPPATO
162x324 cm 63³/₄"x127¹/₂"
 > **NON RECTIFIED / NON RETTIFICATO**
 AL91 Grigio Intenso Polished ± 12 mm ST *



120x278 cm 47¹/₄"x109¹/₂"
 AOSE Marvel Bianco Fantastico 120x278 Lappato
 AOSF Marvel Grigio Intenso 120x278 Lappato
 AOSG Marvel Black Atlantis 120x278 Lappato
 AL2I Marvel Ultramarine 120x278 Lappato *



120x240 cm 47¹/₄"x94¹/₂"
 A03P Marvel Bianco Fantastico 120x240 Lappato
 A03Q Marvel Grigio Intenso 120x240 Lappato
 A03R Marvel Black Atlantis 120x240 Lappato

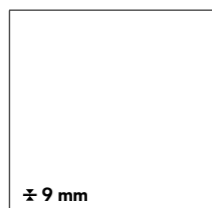

120x120 cm 47¹/₄"x47¹/₄"
 AL7N Marvel Bianco Fantastico 120x120 Lappato
 AL7O Marvel Grigio Intenso 120x120 Lappato
 AL7P Marvel Black Atlantis 120x120 Lappato



60x120 cm 23⁵/₈"x47¹/₄"
 A21J Marvel Bianco Fantastico 60x120 Lappato
 A21I Marvel Black Atlantis 60x120 Lappato

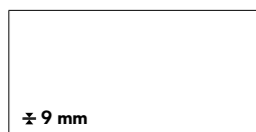

75x150 cm 29¹/₂"x59"

AORS Marvel Bianco Fantastico 75x150 Lappato
 AORU Marvel Grigio Intenso 75x150 Lappato
 AORT Marvel Morning Sky 75x150 Lappato
 AORV Marvel Black Atlantis 75x150 Lappato
 AL2D Marvel Ultramarine 75x150 Lappato
 AL2E Marvel Brazil Green 75x150 Lappato
 AL2C Marvel Crystal Beauty 75x150 Lap. Book. A
 AOUF Marvel Crystal Beauty 75x150 Lap. Book. B

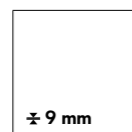

75x75 cm 29¹/₂"x29¹/₂"

AORW Marvel Bianco Fantastico 75x75 Lappato
 AORY Marvel Grigio Intenso 75x75 Lappato
 AORX Marvel Morning Sky 75x75 Lappato
 AORZ Marvel Black Atlantis 75x75 Lappato
 AL2G Marvel Ultramarine 75x75 Lappato
 AL2H Marvel Brazil Green 75x75 Lappato

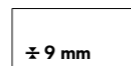

37,5x75 cm 14³/₄"x29¹/₂"

AOR8 Marvel Bianco Fantastico 37,5x75 Lappato
 AOSA Marvel Grigio Intenso 37,5x75 Lappato
 AOR9 Marvel Morning Sky 37,5x75 Lappato
 AOSD Marvel Black Atlantis 37,5x75 Lappato

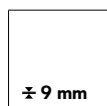

60x60 cm 23⁵/₈"x23⁵/₈"

AL2N Marvel Bianco Fantastico 60x60 Lappato
 AL7L Marvel Grigio Intenso 60x60 Lappato
 AL2O Marvel Morning Sky 60x60 Lappato
 AL7M Marvel Black Atlantis 60x60 Lappato

* **ULTRAMARINE 120x278 cm: GLAZED PORCELAIN TILES** / ULTRAMARINE 120x278 cm: GRES PORCELLANATO SMALTATO / Ultramarine 120x278 cm: carreaux en grès cérame émaillé / Ultramarine 120x278 cm: glasierte Feinsteinzeugfliesen / Ultramarine 120x278 cm: mosaico de gres porcelánico esmaltado / Ultramarine 120x278 cm: глазурованный керамогранит.

The glossy polished finish is suitable for residential or low-traffic commercial floors, where no anti-slip performance is required, and for walls. The polished glossy surface finish, surprisingly brilliant and bright, features slight irregularities typical of natural marble. The extraordinary brilliance and the easy cleaning of the surface are the result of in-depth research aimed at guaranteeing its durability over time. If the product is in direct contact with the outdoors, provide devices for absorbing moisture and dirt to prevent scratches. / La finitura lappata lucida è indicata per pavimenti residenziali o commerciali poco sollecitati, laddove non siano richieste prestazioni antiscivolo, e per rivestimenti. La finitura lappata lucida offre una superficie sorprendentemente brillante e specchiante, con lievi irregolarità tipiche dei marmi naturali. La straordinaria lucentezza e l'elevata pulibilità della superficie sono frutto di studi approfonditi e accurate ricerche tecniche volte a garantirne la persistenza nel tempo. Se il prodotto è a diretto contatto con l'esterno, prevedere dei dispositivi di assorbimento dell'umidità e della sporcizia per prevenire la formazione di graffi.

POLISHED SURFACE | SUPERFICIE LAPPATA | Surface adouci | Geläpft oberfläche | Superficie bruidido | Полуполированный поверхность

* **WITH FIBERGLASS MESH** | VERSIONE STUOIATA | Version à nattes | Ausführung mit Glasfasermatte | Versión con malla | C упорочением из стекловолоконка **NON RECTIFIED** | NON RETTIFICATO | Non rectifié | Nicht rektifiziert | No rectificada | Неретицированные



V2 SLIGHT VARIATION
 Bianco Fantastico,
 Grigio Intenso,
 Crystal Beauty,
 Black Atlantis



V3 MODERATE VARIATION
 Brazil Green,
 Morning Sky,
 Ultramarine



BIANCO FANTASTICO



MORNING SKY



GRIGIO INTENSO

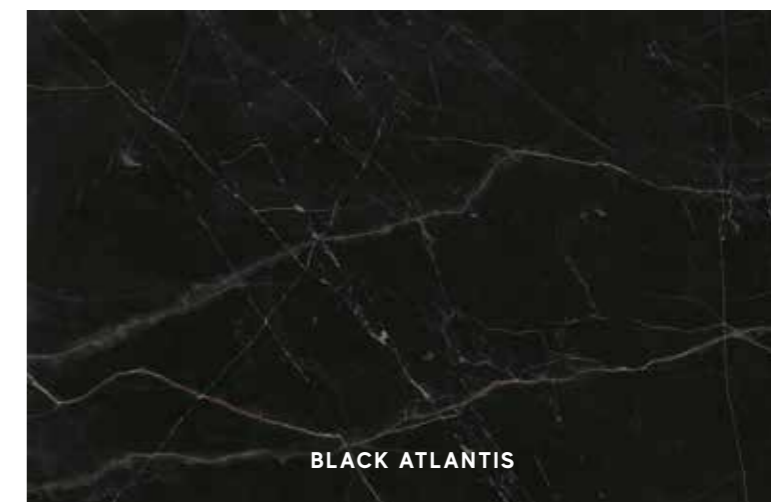

BLACK ATLANTIS



BRAZIL GREEN

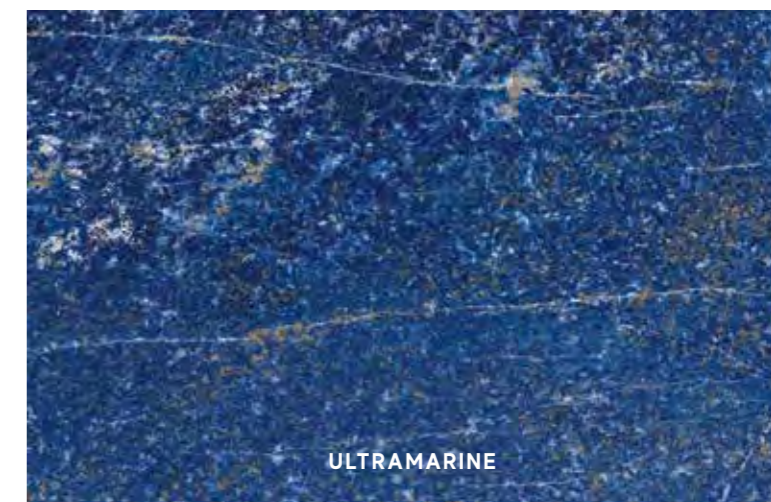

ULTRAMARINE

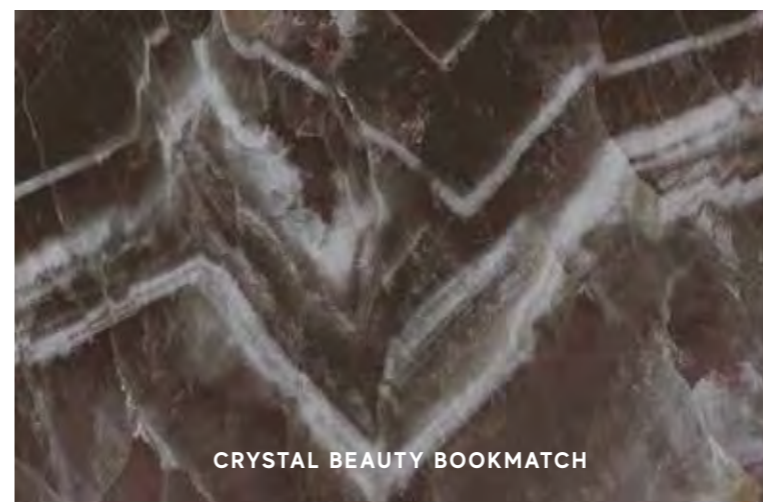

CRYSTAL BEAUTY BOOKMATCH

MARVEL DREAM Porcelain Tiles / Gres Porcellanato

MATTE SURFACE / SUPERFICIE MATT



atlasPLAN p. 500



SILK
162x324 cm 63³/₄"x127¹/₂"
 > **NON RECTIFIED / NON RETTIFICATO**
 A2Y1 Grigio Intenso Silk ± 6 mm ST *
 AØY9 Grigio Intenso Silk ± 12 mm ST *



120x278 cm 47¹/₄"x109¹/₂"
 A2RR Marvel Bianco Fantastico 120x278 Matt
 A2RQ Marvel Black Atlantis 120x278 Matt

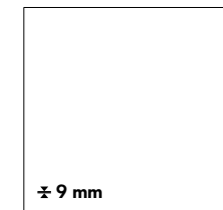

120x120 cm 47¹/₄"x47¹/₄"
 A2Ø3 Marvel Bianco Fantastico 120x120 Matt
 A2ØZ Marvel Black Atlantis 120x120 Matt



60x120 cm 23³/₈"x47¹/₄"
 A21B Marvel Bianco Fantastico 60x120 Matt
 A21A Marvel Black Atlantis 60x120 Matt

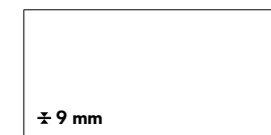

75x150 cm 29¹/₂"x59"

AORØ Marvel Bianco Fantastico 75x150 Matt
 AOR2 Marvel Grigio Intenso 75x150 Matt
 AOR1 Marvel Morning Sky 75x150 Matt
 AOR3 Marvel Black Atlantis 75x150 Matt

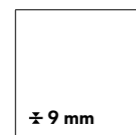

75x75 cm 29¹/₂"x29¹/₂"

AOR4 Marvel Bianco Fantastico 75x75 Matt
 AOR6 Marvel Grigio Intenso 75x75 Matt
 AOR5 Marvel Morning Sky 75x75 Matt
 AOR7 Marvel Black Atlantis 75x75 Matt

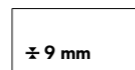

37,5x75 cm 14³/₄"x29¹/₂"

AOSH Marvel Bianco Fantastico 37,5x75 Matt
 AOSJ Marvel Grigio Intenso 37,5x75 Matt
 AOSI Marvel Morning Sky 37,5x75 Matt
 AOSK Marvel Black Atlantis 37,5x75 Matt

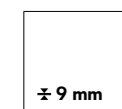

60x60 cm 23³/₈"x23³/₈"

AL2J Marvel Bianco Fantastico 60x60 Matt
 AL2L Marvel Grigio Intenso 60x60 Matt
 AL2K Marvel Morning Sky 60x60 Matt
 AL2M Marvel Black Atlantis 60x60 Matt



BIANCO FANTASTICO



MORNING SKY

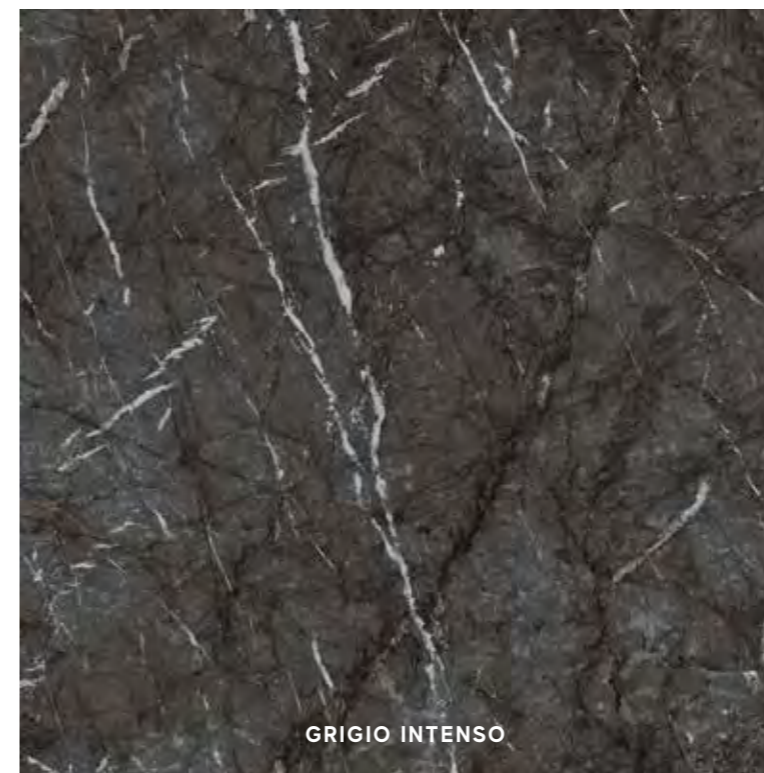

GRIGIO INTENSO

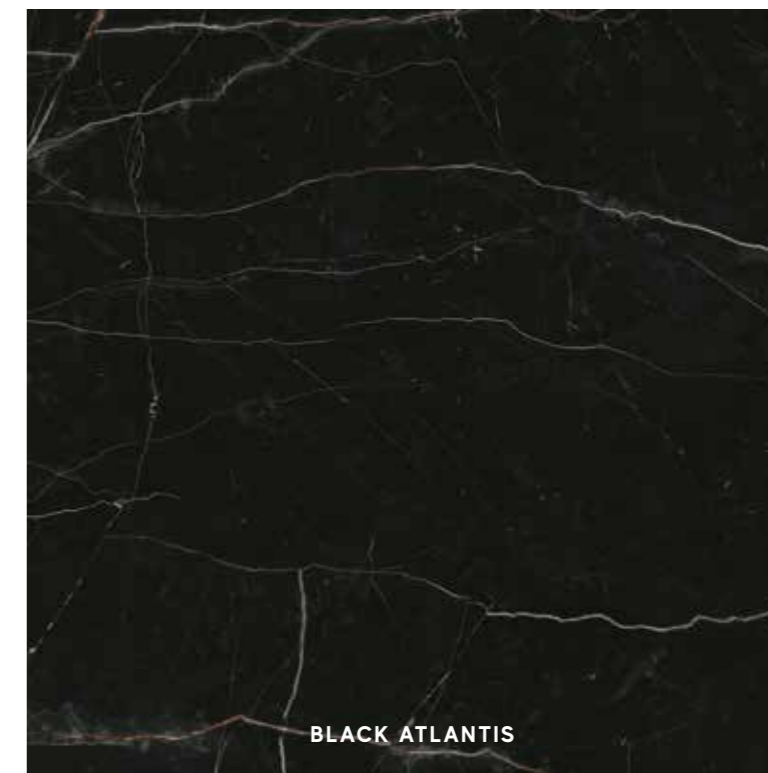

BLACK ATLANTIS

MATTE SURFACE | SUPERFICIE MATT | Surface Mat | Matt oberfläche | Superficie Mate | Матовая поверхность

* WITH FIBERGLASS MESH | VERSIONE STUOIATA | Version à nattes | Ausführung mit Glasfasermatte | Versión con malla | С упрочнением из стекловолоконка
 NON RECTIFIED | NON RETTIFICATO | Non rectifié | Nicht rektifiziert | No rectificada | Неретифицированные

V2
 SLIGHT
 VARIATION

MARVEL DREAM Porcelain Tiles / Gres Porcellanato

DECOR RANGE / GAMMA DECORI

MARBLE LOOK

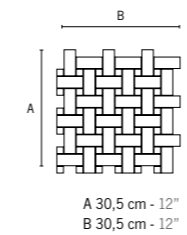
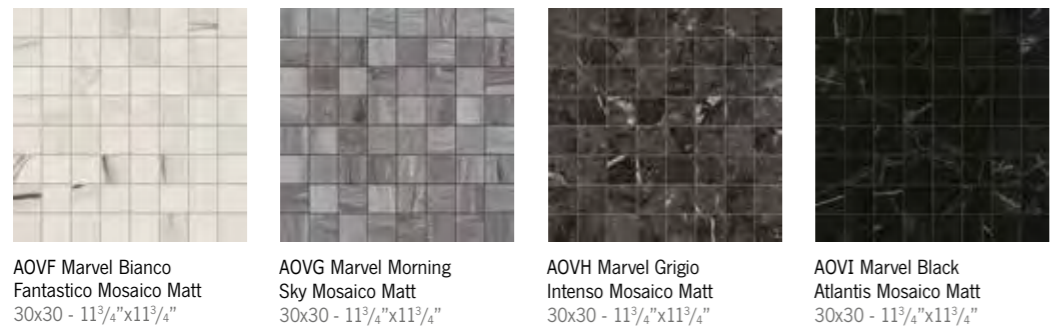
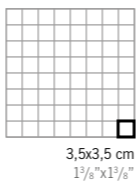
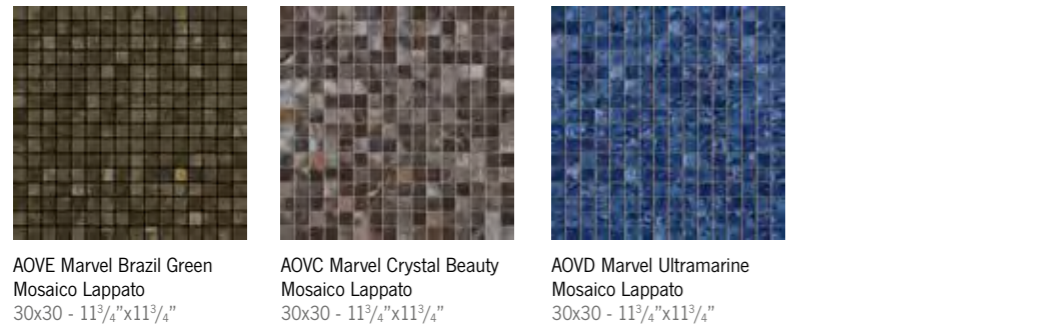
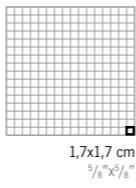
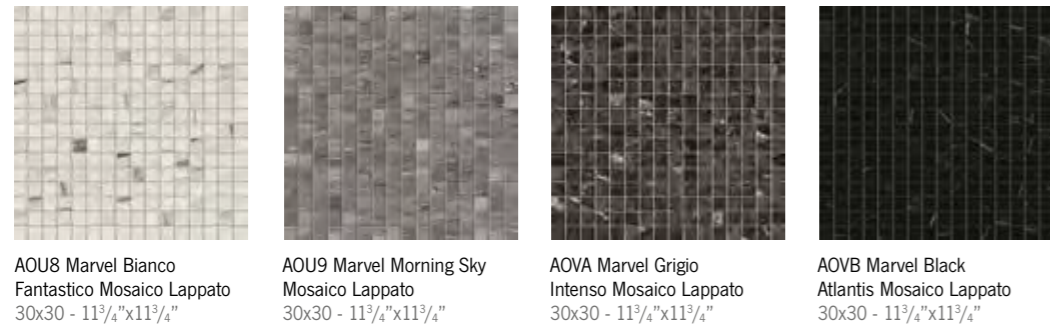
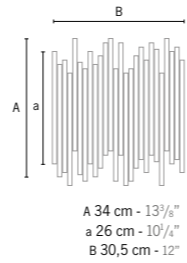
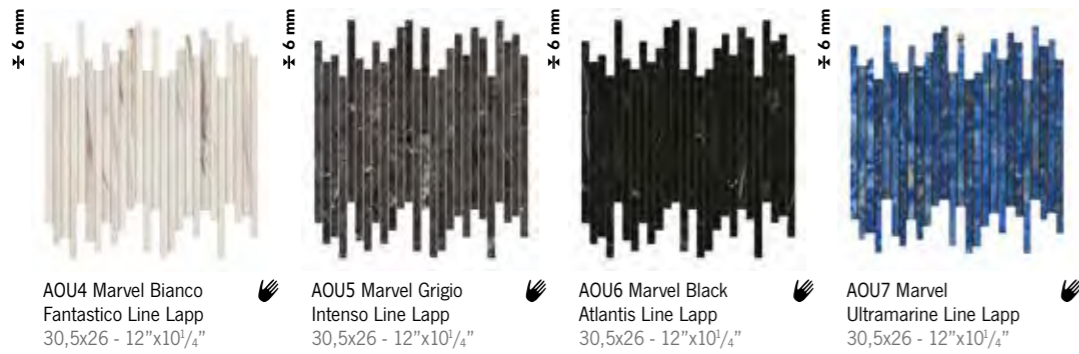

Bianco Fantastico + Black Atlantis | Morning Sky + Black Atlantis | Grigio Intenso + Black Atlantis

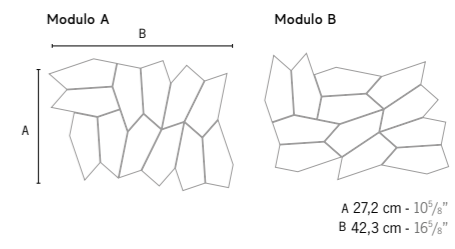
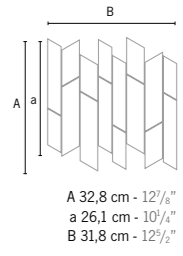
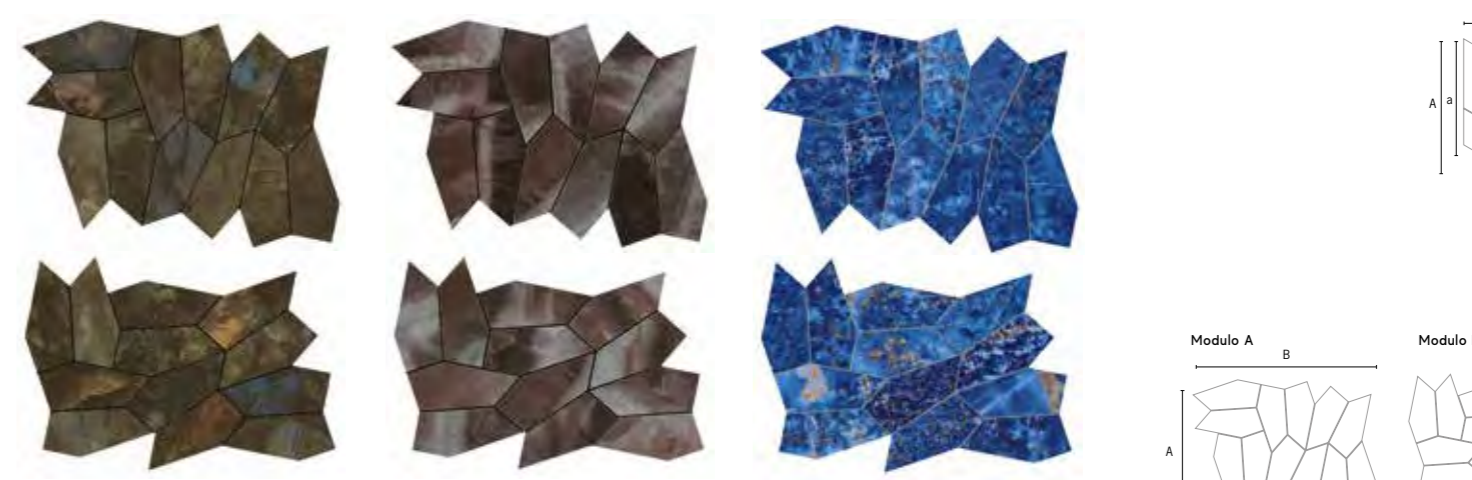

AOVS Marvel Bianco Fantastico Liberty Lappato | AOVR Marvel Morning Sky Liberty Lappato | AOVT Marvel Grigio Intenso Liberty Lappato | AOVM Marvel Brazil Green Liberty Lappato | AOVI Marvel Crystal Beauty Liberty Lappato | AOVI Marvel Ultramarine Liberty Lappato | AOVO Marvel Brazil Green Leaf Lapp | AOVM Marvel Crystal Beauty Leaf Lapp | AOVI Marvel Ultramarine Leaf Lapp

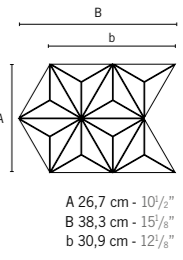
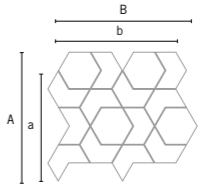

AOVI Marvel Bianco Fantastico Hex | AOVI Marvel Morning Sky Hex | AOVI Grigio Intenso Sky Hex | AOVI Black Atlantis Sky Hex | AOVI Marvel Star Lapp

Grigio Intenso + Crystal Beauty + Black Atlantis

TRIM TILES / PEZZI SPECIALI

	Battiscopa		Gradino		Scalino		Scalino		Scalino Angolare				Battiscopa Sag. Scala											
	Lapp.	Matt.	Lapp.	Matt.	Lapp.	Matt.	Lapp.	Matt.	Lapp.	Matt.	Lapp.	Matt.	Lapp.	Matt.	Lapp.	Matt.								
Bianco F.	AOWE	AOWA	AOV2	AOV6	AO61	AO65	AO7L	AO7H	AO7D	AO69	-	-	APAG	APAF	AO95	AO94	-	-	AO9Z	AO9Y	AO9T	AO9S	AOWL	AOWP
Morning Sky	AOWF	AOWB	AOV3	AOV7	AO62	AO66	AO7M	AO7I	AO7E	AO7A	-	-	APAI	APAH	AO97	AO96	-	-	AO91	AO90	AO9V	AO9U	AOWM	AOWQ
Grigio Intenso	AOWG	AOWC	AOV4	AOV8	AO63	AO67	AO7N	AO7J	AO7F	AO7B	AO98	AO92	-	-	-	-	AO9W	AO9Q	-	-	-	-	AOWN	AOWR
Black Atlantis	AOWH	AOWD	AOV5	AOV9	AO64	AO68	AO7O	AO7K	AO7G	AO7C	AO99	AO93	-	-	-	-	AO9X	AO9R	-	-	-	-	AOWO	AOWS
Crystal Beauty	AOWI	-	-	-	-	-	AO7P	-	-	-	-	-	APAK	APAJ	-	-	-	-	-	-	-	-	-	-
Ultramarine	AOWJ	-	-	-	-	-	AO7Q	-	-	-	APAD	-	-	-	-	-	-	-	-	-	-	-	-	-
Brazil Green	AOWK	-	-	-	-	-	AO7R	-	-	-	APAE	-	-	-	-	-	-	-	-	-	-	-	-	-

* THESE PARTS ARE SUPPLIED TO ORDER | I PEZZI SONO DISPONIBILI SU ORDINAZIONE | Les pièces sont disponibles sur commande | Die Teile sind auf Bestellung lieferbar | Las piezas se hacen por encargo | Изготавливаются на заказ

MARBLE LOOK



MARVEL

DREAM

WALL TILES

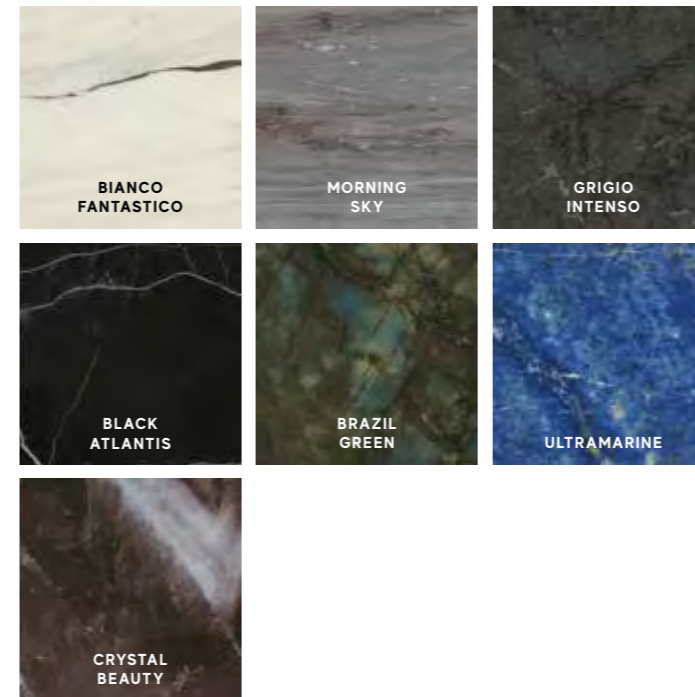

Wall Tiles / Rivestimento

WHITEBODY WALL TILES - RECTIFIED MONOCALIBER
RIVESTIMENTI IN PASTA BIANCA - RETTIFICATO MONOCALIBRO

Sizes	Thickness	Surface finish
50x120 cm - 19 ⁵ / ₈ "x47 ¹ / ₄ "	± 8,5 mm	Shiny

DECORATIVE RANGE / GAMMA DECORATIVA

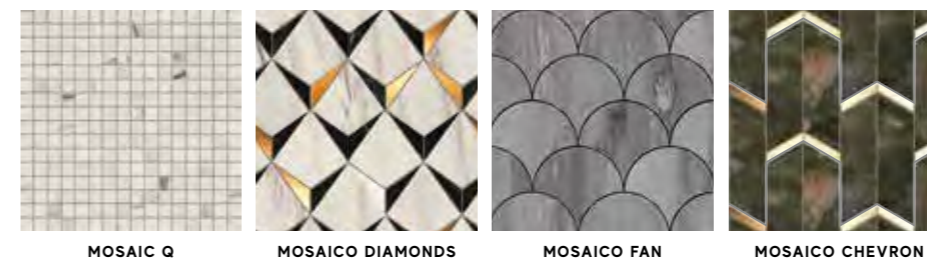

WHITEBODY WALL TILES | RIVESTIMENTI IN PASTA BIANCA | Revêtements en pâte blanche | Weißscherbige Wandfliesen | Revestimientos en pasta blanca | Настенная плитка из белой глины
RECTIFIED MONOCALIBER | RETTIFICATO MONOCALIBRO | Rectifié mono-calibre | Geschliffen einkalibrig | Rectificado monocalibré | Ретицированный в одном калибре

MARVEL DREAM Wall Tiles / Rivestimento

SHINY SURFACE / SUPERFICIE LUCIDA



MARBLE LOOK

WALL TILES



A4SF Marvel Bianco Fantastico 50x120
50x120 cm - 19⁵/₈"x47¹/₄"



A4SJ Marvel Morning Sky 50x120
50x120 cm - 19⁵/₈"x47¹/₄"



A4SG Marvel Grigio Intenso 50x120
50x120 cm - 19⁵/₈"x47¹/₄"

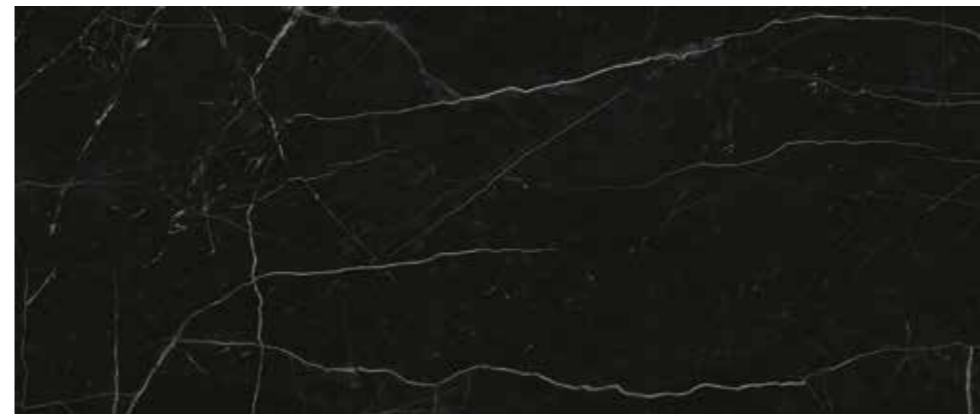

A4SI Marvel Black Atlantis 50x120
50x120 cm - 19⁵/₈"x47¹/₄"



A4SE Marvel Brazil Green 50x120
50x120 cm - 19⁵/₈"x47¹/₄"



A4SK Marvel Crystal Beauty 50x120
50x120 cm - 19⁵/₈"x47¹/₄"

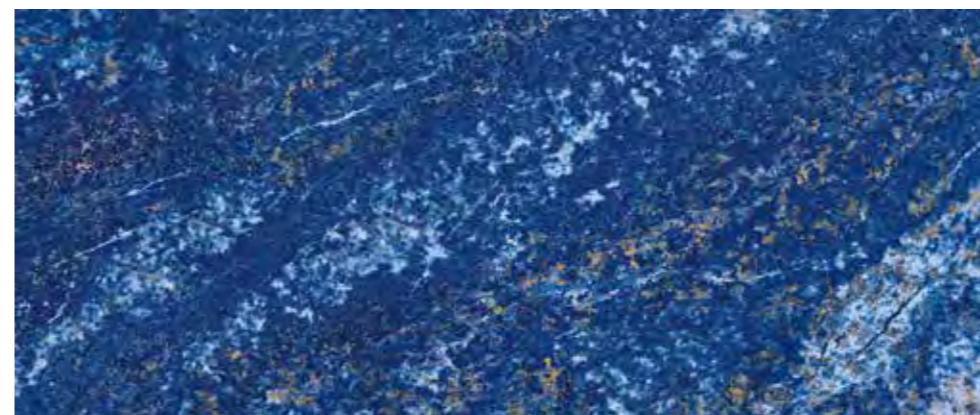

A4SH Marvel Ultramarine 50x120
50x120 cm - 19⁵/₈"x47¹/₄"



V2
SLIGHT
VARIATION
Bianco Fantastico,
Grigio Intenso



V3
MODERATE
VARIATION
Morning Sky



V2
SLIGHT
VARIATION
Black Atlantis



V3
MODERATE
VARIATION
Brazil Green,
Ultramarine,
Crystal Beauty

MARBLE LOOK

WALL TILES

MARVEL DREAM Wall Tiles / Rivestimento

DECOR RANGE / GAMMA DECORI

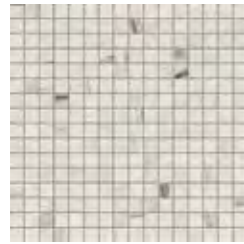

9MQI Marvel Bianco Fantastico Mosaic Q
30,5x30,5 - 12"x12"

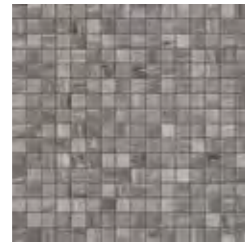

9MQS Marvel Morning Sky Mosaic Q
30,5x30,5 - 12"x12"

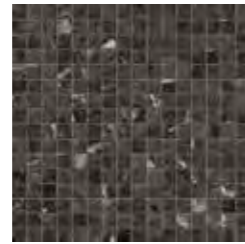

9MQG Marvel Grigio Intenso Mosaic Q
30,5x30,5 - 12"x12"

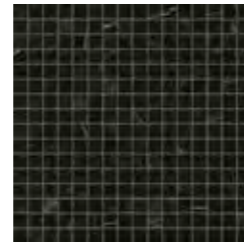

9MQK Marvel Black Atlantis Mosaic Q
30,5x30,5 - 12"x12"

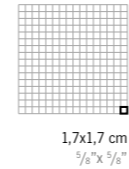

9MQH Marvel Brazil Green Mosaic Q
30,5x30,5 - 12"x12"



9MQT Marvel Crystal Beauty Mosaic Q
30,5x30,5 - 12"x12"



9MQD Marvel Ultramarine Mosaic Q
30,5x30,5 - 12"x12"



9MDB Marvel Diamonds Bianco - Black
35,8x32,9 - 14 1/8"x13"



9MDN Marvel Diamonds Bianco - Ultramarine
35,8x32,9 - 14 1/8"x13"



9MDG Marvel Diamonds Bianco - Green
35,8x32,9 - 14 1/8"x13"

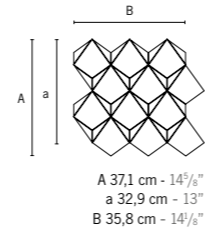

9MFB Marvel Fan Bianco Fantastico
29x29,2 - 11 3/8"x11 1/2"



9MFS Marvel Fan Morning Sky
29x29,2 - 11 3/8"x11 1/2"



9MFG Marvel Fan Grigio Intenso
29x29,2 - 11 3/8"x11 1/2"



9MFK Marvel Fan Black Atlantis
29x29,2 - 11 3/8"x11 1/2"

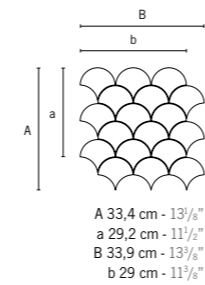

9MFE Marvel Fan Brazil Green
29x29,2 - 11 3/8"x11 1/2"



9MFL Marvel Fan Crystal Beauty
29x29,2 - 11 3/8"x11 1/2"



9MFM Marvel Fan Ultramarine
29x29,2 - 11 3/8"x11 1/2"



9MCN Marvel Chevron Bianco Fantastico
17x41,4 - 6 3/4"x16 1/8"



9MCO Marvel Chevron Brazil Green
17x41,4 - 6 3/4"x16 1/8"



9MCP Marvel Chevron Ultramarine
17x41,4 - 6 3/4"x16 1/8"

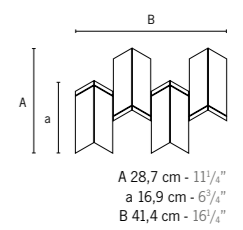

• For gold pieces, use an ordinary neutral cleaner. Avoid using acid or alkaline products, waxes and scour pads. / Parti in oro. Si consiglia l'utilizzo di un comune detergente neutro. Evitare l'utilizzo di prodotti acidi o alcalini, ceranti e pagliette di metallo. / Détails en or. Nous vous conseillons d'utiliser un détergent commun neutre. Evitez d'utiliser tout produit acide ou alcalin, cirants et grattoirs. / Vergoldete Teile. Verwenden Sie ein normales, neutrales Reinigungsmittel. Saure oder alkalische Produkte, Wache und Metallschwämme sind zu vermeiden. / Partes de oro. Se aconseja utilizar un detergente neutro habitual. Hay que evitar el empleo de productos ácidos o alcalinos, ceras y estropaños de metal. / Золотые детали. Рекомендуется чистить обычным нейтральным моющим средством. Не рекомендуется использовать кислотные, щелочные, восковые средства, а также металлические мочалки.



One of the six sheets in the box contains a golden tile with the Atlas Concorde logo. / Uno dei sei fogli contenuti nella scatola contiene una tessera dorata con logo Atlas Concorde. / Une des six feuilles dans la boîte contient une tesselle dorée avec logo Atlas Concorde. / Eine der sechs Matten im Karton enthält ein goldfarbnes Mosaiksteinchen mit dem Atlas Concorde-Logo. / En la caja encontrarán 6 folios, uno de éstos contiene una tarjeta dorada con el logotipo Atlas Concorde. / Один из шести листов, помещенных в коробку, содержит золотую табличку с логотипом Atlas Concorde.

TRIM TILES / PEZZI SPECIALI

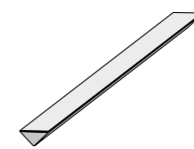

1,4x50 cm - 5/8"x19 5/8"
LD5B Marvel Bianco Fantastico Corner 50 *
LD5S Marvel Morning Sky Corner 50 *
LD5G Marvel Grigio Intenso Corner 50 *
LD5N Marvel Black Atlantis Corner 50 *
LD5M Marvel Ultramarine Corner 50 *
LD5E Marvel Brazil Green Corner 50 *
LD5C Marvel Crystal Beauty Corner 50 *



1,4x1,4 cm - 5/8"x5/8"
MD1B Marvel Bianco Fantastico Corner A.E. 1,4 *
MD1S Marvel Morning Sky Corner A.E. 1,4 *
MD1G Marvel Grigio Intenso Corner A.E. 1,4 *
MD1N Marvel Black Atlantis Corner A.E. 1,4 *
MD1M Marvel Ultramarine Corner A.E. 1,4 *
MD1E Marvel Brazil Green Corner A.E. 1,4 *
MD1C Marvel Crystal Beauty Corner A.E. 1,4 *

* THESE PARTS ARE SUPPLIED TO ORDER. I PEZZI SONO DISPONIBILI SU ORDINAZIONE
Les pièces sont disponibles sur commande | Die Teile sind auf Bestellung lieferbar | Las piezas se hacen por encargo | Изготавливаются на заказ



MARVEL

EDGE

PORCELAIN&WALL TILES

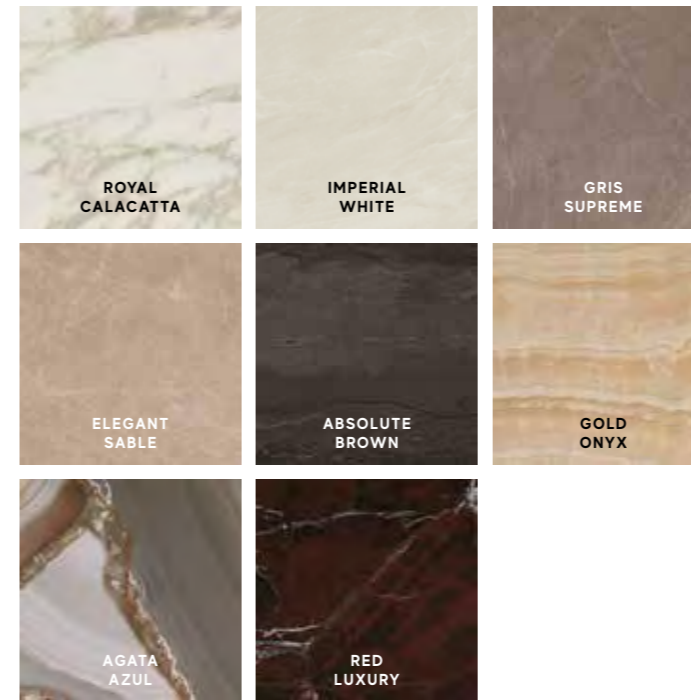

Porcelain Tiles / Gres Porcellanato

COLOURED BODY PORCELAIN TILES - RECTIFIED MONOCALIBER
GRES PORCELLANATO COLORATO IN MASSA - RETTIFICATO MONOCALIBRO

LARGE SIZES p. 500

Sizes	Thickness	Surface finish
162x324 cm - 63 ³ / ₄ "x127 ¹ / ₂ " NON RECTIFIED - NON RETTIFICATO	± 12 mm	Polished
120x278 cm - 47 ¹ / ₄ "x109 ¹ / ₂ "	± 6 mm	Polished
120x240 cm - 47 ¹ / ₄ "x94 ¹ / ₂ "	± 9 mm	Polished
120x120 cm - 47 ¹ / ₄ "x47 ¹ / ₄ "	± 9 mm	Polished
75x150 cm - 29 ¹ / ₂ "x59"	± 9 mm	Polished
75x75 cm - 29 ¹ / ₂ "x29 ¹ / ₂ "	± 9 mm	Polished
45x90 cm - 17 ³ / ₄ "x35 ³ / ₈ "	± 9 mm	Polished
60x60 cm - 23 ⁵ / ₈ "x23 ⁵ / ₈ "	± 9 mm	Polished Matte R9 A
30x60 cm - 11 ³ / ₄ "x23 ⁵ / ₈ "	± 9 mm	Polished Matte R9 A

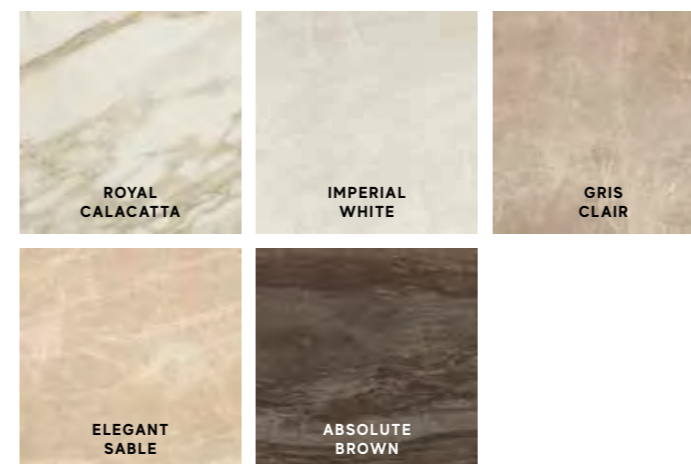

Wall Tiles / Rivestimento

WHITEBODY WALL TILES - RECTIFIED MONOCALIBER
RIVESTIMENTI IN PASTA BIANCA - RETTIFICATO MONOCALIBRO

Sizes	Thickness	Surface finish
50x120 cm - 19 ⁵ / ₈ "x47 ¹ / ₄ "	± 8,5 mm	Shiny
40x80 cm - 15 ³ / ₄ "x31 ¹ / ₂ "	± 8,5 mm	Shiny

MARVEL EDGE Porcelain Tiles / Gres Porcellanato

POLISHED SURFACE / SUPERFICIE LAPPATA



atlasPLAN p. 500



POLISHED / LAPPATO
162x324 cm 63^{3/4}"x127^{1/2}"
 > **NON RECTIFIED / NON RETTIFICATO**
 AA17 Calacatta Royal Polished ± 12 mm ST *
 AA9M Calacatta Royal Bookmatch Polished ± 12 mm ST *



120x278 cm 47^{1/4}"x109^{1/2}"
 AQBH Marvel Royal Calacatta Lappato
 AOQC Marvel Absolute Brown Lappato



120x240 cm 47^{1/4}"x94^{1/2}"
 AENU Marvel Royal Calacatta 120x240 Lappato

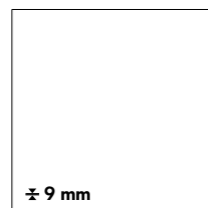

120x120 cm 47^{1/4}"x47^{1/4}"
 AENP Marvel Royal Calacatta 120x120 Lappato
 AENQ Marvel Imperial White 120x120 Lappato
 AENK Marvel Elegant Sable 120x120 Lappato
 AENN Marvel Gris Supreme 120x120 Lappato
 AENO Marvel Absolute Brown 120x120 Lappato

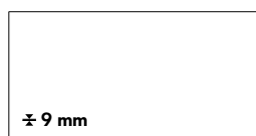

75x150 cm 29^{1/2}"x59"
 AA1M Marvel Royal Calacatta 75x150 Lappato
 AA1N Marvel Imperial White 75x150 Lappato
 AA1J Marvel Elegant Sable 75x150 Lappato
 AA1K Marvel Gris Supreme 75x150 Lappato
 AA1L Marvel Absolute Brown 75x150 Lappato

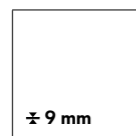

75x75 cm 29^{1/2}"x29^{1/2}"
 AA1W Marvel Royal Calacatta 75x75 Lappato
 AA1X Marvel Imperial White 75x75 Lappato
 AA1S Marvel Elegant Sable 75x75 Lappato
 AA1T Marvel Gris Supreme 75x75 Lappato
 AA1U Marvel Absolute Brown 75x75 Lappato

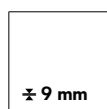

60x60 cm 23^{5/8}"x23^{5/8}"
 AEN4 Marvel Royal Calacatta 60x60 Lappato
 AEN5 Marvel Imperial White 60x60 Lappato
 AEN1 Marvel Elegant Sable 60x60 Lappato
 AEN2 Marvel Gris Supreme 60x60 Lappato
 AEN3 Marvel Absolute Brown 60x60 Lappato



30x60 cm 11^{3/4}"x23^{5/8}"
 AEN9 Marvel Royal Calacatta 30x60 Lappato
 AEOA Marvel Imperial White 30x60 Lappato
 AEN6 Marvel Elegant Sable 30x60 Lappato
 AEN7 Marvel Gris Supreme 30x60 Lappato
 AEN8 Marvel Absolute Brown 30x60 Lappato



45x90 cm 17^{3/4}"x35^{3/8}"
 AENZ Marvel Royal Calacatta 45x90 Lappato
 AEN0 Marvel Imperial White 45x90 Lappato
 AENW Marvel Elegant Sable 45x90 Lappato
 AENX Marvel Gris Supreme 45x90 Lappato
 AENY Marvel Absolute Brown 45x90 Lappato



V2
SLIGHT
VARIATION
 Imperial White,
 Elegant Sable,
 Gris Supreme



V3
MODERATE
VARIATION
 Royal Calacatta,
 Absolute Brown



ROYAL CALACATTA



IMPERIAL WHITE



GRIS SUPREME



ELEGANT SABLE



ABSOLUTE BROWN

The glossy polished finish is suitable for residential or low-traffic commercial floors, where no anti-slip performance is required, and for walls. The polished glossy surface finish, surprisingly brilliant and bright, features slight irregularities typical of natural marble. The extraordinary brilliance and the easy cleaning of the surface are the result of in-depth research aimed at guaranteeing its durability over time. If the product is in direct contact with the outdoors, provide devices for absorbing moisture and dirt to prevent scratches. / La finitura lappata lucida è indicata per pavimenti residenziali o commerciali poco sollecitati, laddove non siano richieste prestazioni antiscivolo, e per rivestimenti. La finitura lappata lucida offre una superficie sorprendentemente brillante e specchiante, con lievi irregolarità tipiche dei marmi naturali. La straordinaria lucentezza e l'elevata pulibilità della superficie sono frutto di studi approfonditi e accurate ricerche tecniche volte a garantirne la persistenza nel tempo. Se il prodotto è a diretto contatto con l'esterno, prevedere dei dispositivi di assorbimento dell'umidità e della sporcizia per prevenire la formazione di graffi.

POLISHED SURFACE | SUPERFICIE LAPPATA | Surface adouci | Gelläppt oberfläche | Superficie brulido | Полиполированный поверхность

* **WITH FIBERGLASS MESH** | VERSIONE STUOIATA | Version à nattes | Ausführung mit Glasfasermatte | Versión con malla | С упрочнением из стекловолоконка
NON RECTIFIED | NON RETTIFICATO | Non rectifié | Nicht rektifiziert | No rectificada | Неретифицированные

MARVEL EDGE Porcelain Tiles / Gres Porcellanato

POLISHED SURFACE / SUPERFICIE LAPPATA *



75x150 cm 29 1/2" x 59"
AAIO Marvel Gold Onyx 75x150 Lappato
AAIP Marvel Agata Azul 75x150 Lappato
AAIQ Marvel Red Luxury 75x150 Lappato

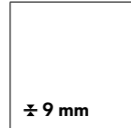

75x75 cm 29 1/2" x 29 1/2"
AAIY Marvel Gold Onyx 75x75 Lappato
AAIØ Marvel Agata Azul 75x75 Lappato
AAI5 Marvel Red Luxury 75x75 Lappato



GOLD ONYX

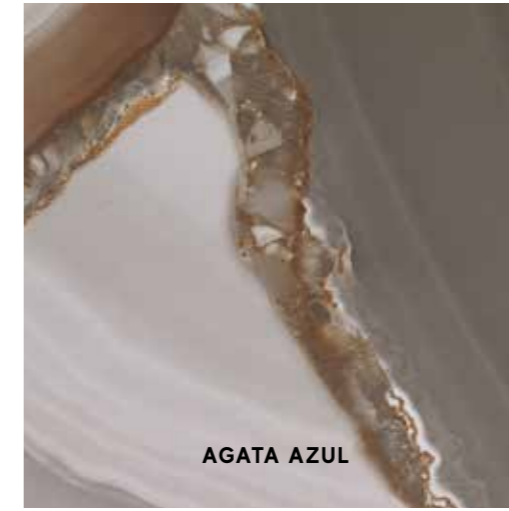

AGATA AZUL

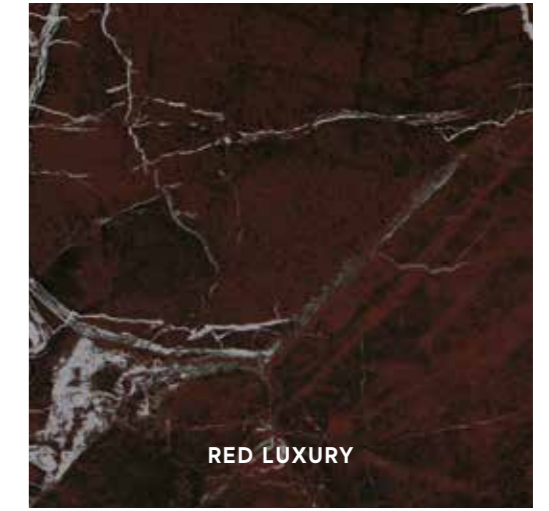

RED LUXURY

MARBLE LOOK

MARBLE LOOK

MATTE SURFACE / SUPERFICIE MATT

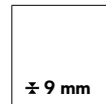

60x60 cm 23 3/8" x 23 3/8"
AE0E Marvel Royal Calacatta 60x60 Matt
AE0F Marvel Imperial White 60x60 Matt
AE0B Marvel Elegant Sable 60x60 Matt
AE0C Marvel Gris Supreme 60x60 Matt
AE0D Marvel Absolute Brown 60x60 Matt

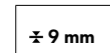

30x60 cm 11 3/4" x 23 3/8"
AE0J Marvel Royal Calacatta 30x60 Matt
AE0K Marvel Imperial White 30x60 Matt
AE0G Marvel Elegant Sable 30x60 Matt
AE0H Marvel Gris Supreme 30x60 Matt
AE0I Marvel Absolute Brown 30x60 Matt



ROYAL CALACATTA



IMPERIAL WHITE



ELEGANT SABLE



GRIS SUPREME

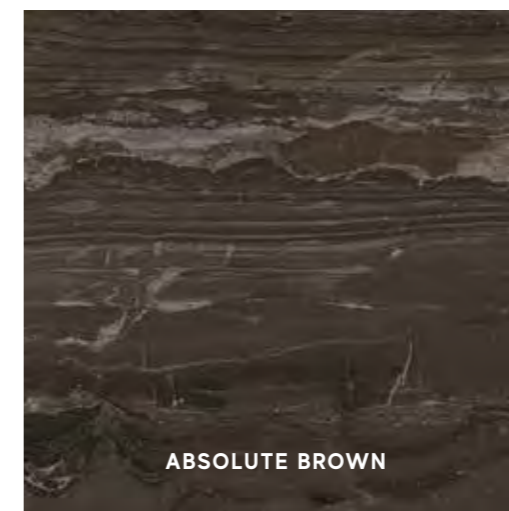

ABSOLUTE BROWN



V2
SLIGHT
VARIATION
Imperial White,
Elegant Sable,
Gris Supreme



V3
MODERATE
VARIATION
Royal Calacatta,
Absolute Brown

* The glossy polished finish is suitable for residential or low-traffic commercial floors, where no anti-slip performance is required, and for walls. The polished glossy surface finish, surprisingly brilliant and bright, features slight irregularities typical of natural marble. The extraordinary brilliance and the easy cleaning of the surface are the result of in-depth research aimed at guaranteeing its durability over time. - If the product is in direct contact with the outdoors, provide devices for absorbing moisture and dirt to prevent scratches. / La finitura lappata lucida è indicata per pavimenti residenziali o commerciali poco sollecitati, laddove non siano richieste prestazioni antiscivolo, e per rivestimenti. La finitura lappata lucida offre una superficie sorprendentemente brillante e specchiante, con lievi irregolarità tipiche dei marmi naturali. La straordinaria lucentezza e l'elevata pulibilità della superficie sono frutto di studi approfonditi e accurate ricerche tecniche volte a garantirne la persistenza nel tempo. - Se il prodotto è a diretto contatto con l'esterno, prevedere dei dispositivi di assorbimento dell'umidità e della sporcizia per prevenire la formazione di graffi.

POLISHED SURFACE | SUPERFICIE LAPPATA | Surface adouci | Gelläppt oberfläche | Superficie brulido | Полуполированный поверхность
MATTE SURFACE | SUPERFICIE MATT | Surface Mat | Matt oberfläche | Superficie Mate | Матовая поверхность

* **WITH FIBERGLASS MESH** | VERSIONE STUOIATA | Version à nattes | Ausführung mit Glasfasermatte | Versión con malla | С упрочнением из стекловолоконка
NON RECTIFIED | NON RETTIFICATO | Non rectifié | Nicht rektifiziert | No rectificada | Неретифицированные

MARVEL EDGE Porcelain Tiles / Gres Porcellanato

DECOR RANGE / GAMMA DECORI

MARBLE LOOK

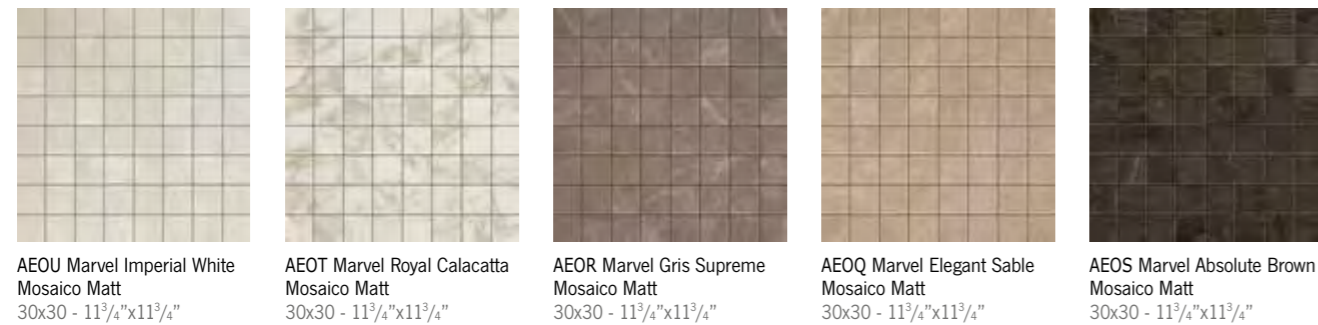
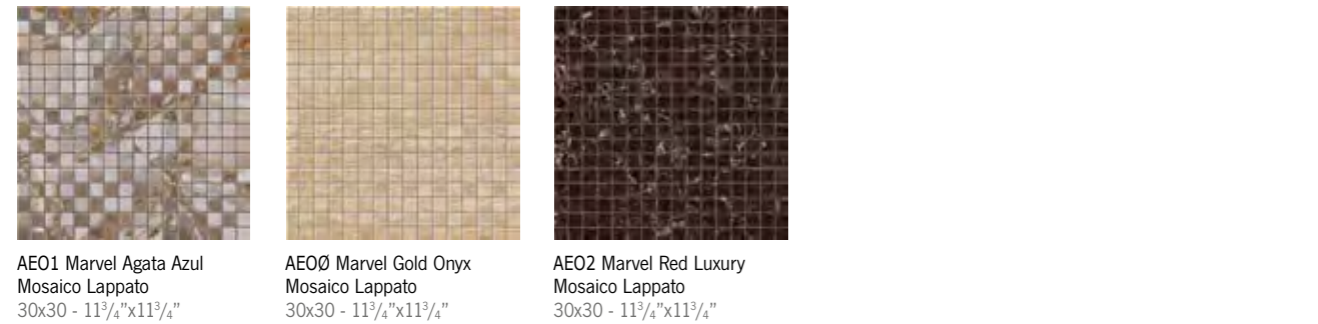
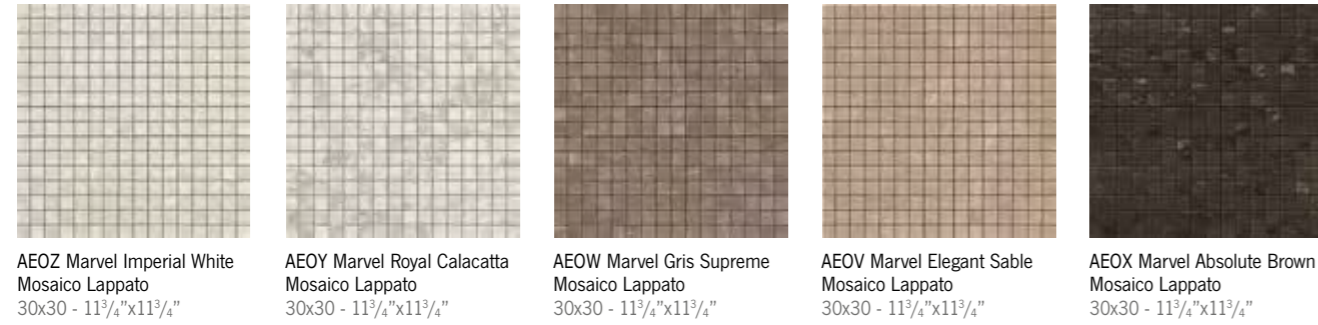

Imperial White + Gris Supreme Royal Calacatta + Gris Supreme Gris Supreme + Royal Calacatta Elegant Sable + Absolute Brown Absolute Brown + Elegant Sable

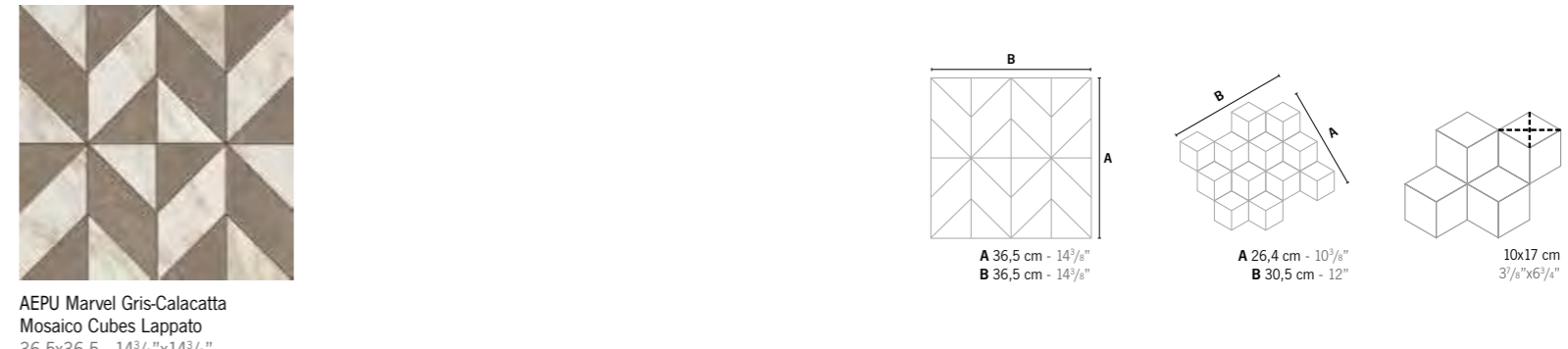
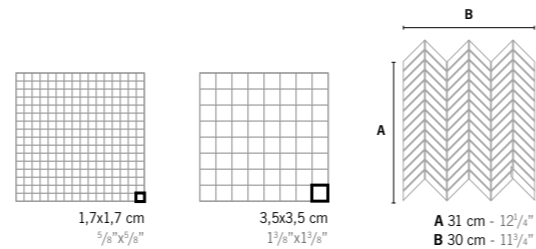

TRIM TILES / PEZZI SPECIALI

p. 568

UPEC p. 595

		Battiscopa		Battiscopa Digitale		Gradino *	Scalino Lappato *	Scalino Lappato *	Scalino *		Scalino Ang. 33x33 - 13"x13"				Battiscopa Matt			
		7,2x60 - 2 7/8"x23 5/8"		4,6x60 - 1 3/4"x23 5/8"					33x60 - 13"x23 5/8"		33x90 - 13"x35 3/8"		Lappato		Matt		7,2x30 - 2 7/8"x11 3/4"	
		Lappato	Matt	Lappato	Matt				Lappato	Matt	DX *	SX *	DX *	SX *	DX *	SX *		
Elegant Sable	AFA9	AFA4	AFB0	AFBH	AFB4	AFCO	AFCJ	AFCE	AFB9	AFC2	AFCW	AFBT	AFBZ					
Gris Supreme	AFBA	AFA5	AFBP	AFBJ	AFB5	AFCP	AFCK	AFCF	AFCA	AFC3	AFCX	AFBV	AFBØ					
Absolute Brown	AFBC	AFA6	AFBQ	AFBK	AFB6	AFCQ	AFCL	AFCG	AFCB	AFC6	AFC7	AFCØ	AFB1					
Royal Calacatta	AFBD	AFA7	AFBR	AFBM	AFB7	AFCR	AFCM	AFCH	AFCC	AFC4	AFCY	AFBX	AFB2					
Imperial White	AFBF	AFA8	AFBS	AFBN	AFB8	AFCS	AFCN	AFCI	AFCD	AFC5	AFCZ	AFBY	AFB3					
Gold Onyx	-	-	-	-	-	AFCT	-	-	-	-	-	-	-					
Agata Azul	-	-	-	-	-	AFCU	-	-	-	-	-	-	-					
Red Luxury	-	-	-	-	-	AFCV	-	-	-	-	-	-	-					

* THESE PARTS ARE SUPPLIED TO ORDER | I PEZZI SONO DISPONIBILI SU ORDINAZIONE | Les pièces sont disponibles sur commande | Die Teile sind auf Bestellung lieferbar | Las piezas se hacen por encargo | Изготавливаются на заказ

THE DECORATION CAN ONLY BE LAID ON THE WALL | IL DECORO SI PUÒ POSARE SOLO A RIVESTIMENTO
 Décor uniquement mural | Das Dekor kann nur an der Wand verlegt werden | La decoración se puede colocar únicamente en paredes | Декор может быть уложен только на стену.

MARBLE LOOK



MARVEL

EDGE

WALL TILES

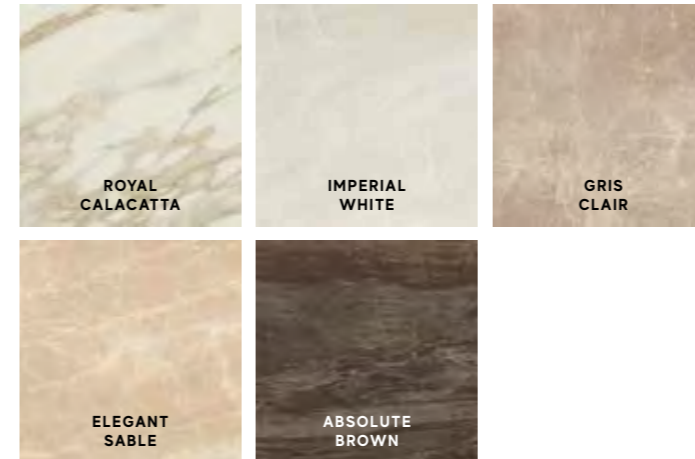

Wall Tiles / Rivestimento

WHITEBODY WALL TILES - RECTIFIED MONOCALIBER
RIVESTIMENTI IN PASTA BIANCA - RETTIFICATO MONOCALIBRO

Sizes	Thickness	Surface finish
50x120 cm - 19 ⁵ / ₈ "x47 ¹ / ₄ "	± 8,5 mm	Shiny
40x80 cm - 15 ³ / ₄ "x31 ¹ / ₂ "	± 8,5 mm	Shiny

DECORATIVE RANGE / GAMMA DECORATIVA



MARVEL EDGE Wall Tiles / Rivestimento

SHINY SURFACE / SUPERFICIE LUCIDA



MARBLE LOOK

WALL TILES



A4SN Marvel Imperial White 50x120
50x120 cm - 19³/₈"x47¹/₄"



A4SL Marvel Royal Calacatta 50x120
50x120 cm - 19³/₈"x47¹/₄"



A4SM Marvel Elegant Sable 50x120
50x120 cm - 19³/₈"x47¹/₄"



9MEW Marvel Imperial White 40x80
40x80 - 15³/₄"x31¹/₂"



9MER Marvel Royal Calacatta 40x80
40x80 - 15³/₄"x31¹/₂"



9MES Marvel Elegant Sable 40x80
40x80 - 15³/₄"x31¹/₂"



9EMG Marvel Gris Clair 40x80
40x80 - 15³/₄"x31¹/₂"



9MEB Marvel Absolute Brown 40x80
40x80 - 15³/₄"x31¹/₂"

TRIM TILES / PEZZI SPECIALI

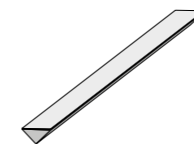

1,4x50 cm - 5⁵/₈"x19⁵/₈"
LM5C Marvel Royal Calacatta Corner 50 •
LM5W Marvel Imperial White Corner 50 •
LM5S Marvel Elegant Sable Corner 50 •

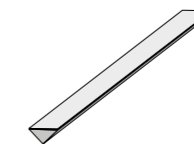

1,4x40 cm - 5⁵/₈"x15³/₄"
LM4C Marvel Royal Calacatta Corner 40 •
LM4W Marvel Imperial White Corner 40 •
LM4S Marvel Elegant Sable Corner 40 •
LM4G Marvel Gris Clair Corner 40 •
LM4O Marvel Absolute Brown Corner 40 •



1,4x1,4 cm - 5⁵/₈"x5⁵/₈"
AMCY Marvel Royal Calacatta Corner A.E. •
AMCX Marvel Imperial White Corner A.E. •
AMCS Marvel Elegant Sable Corner A.E. •
AMCR Marvel Gris Clair Corner A.E. •
AMCO Marvel Absolute Brown Corner A.E. •



V2
SLIGHT
VARIATION
Imperial White,
Elegant Sable



V3
MODERATE
VARIATION
Royal Calacatta



V2
SLIGHT
VARIATION
Imperial White,
Elegant Sable,
Gris Clair



V3
MODERATE
VARIATION
Royal Calacatta,
Absolute Brown

* THESE PARTS ARE SUPPLIED TO ORDER . I PEZZI SONO DISPONIBILI SU ORDINAZIONE
Les pièces sont disponibles sur commande | Die Teile sind auf Bestellung lieferbar | Las piezas se hacen por encargo | Изготавливаются на заказ
SHINY SURFACE | SUPERFICIE LUCIDA | Surface brillante | Glänzende Oberfläche | Superficie brillante | Глянцевая поверхность

MARBLE LOOK

WALL TILES

295

MARVEL EDGE Wall Tiles / Rivestimento

DECOR RANGE / GAMMA DECORI

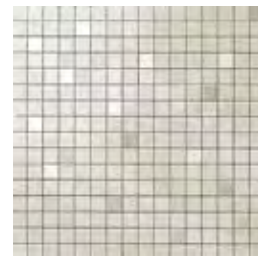

9EQW Marvel Imperial White Mosaic Q
30,5x30,5 - 12"x12"

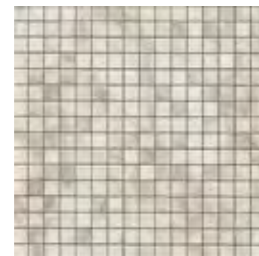

9EQC Marvel Royal Calacatta Mosaic Q
30,5x30,5 - 12"x12"

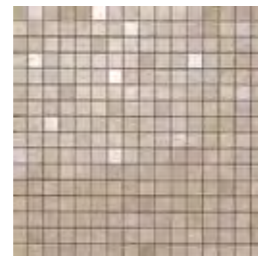

9EQG Marvel Gris Clair Mosaic Q
30,5x30,5 - 12"x12"

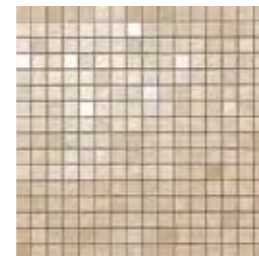

9EQS Marvel Elegant Sable Mosaic Q
30,5x30,5 - 12"x12"

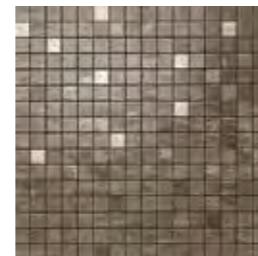

9EQB Marvel Absolute Brown Mosaic Q
30,5x30,5 - 12"x12"



9EDW Marvel Imperial White Drop Mosaic
27,2x29,7 - 10⁵/₈"x11⁵/₈"



9EDC Marvel Royal Calacatta Drop Mosaic
27,2x29,7 - 10⁵/₈"x11⁵/₈"



9EDR Marvel Gris Clair Drop Mosaic
27,2x29,7 - 10⁵/₈"x11⁵/₈"



9EDS Marvel Elegant Sable Drop Mosaic
27,2x29,7 - 10⁵/₈"x11⁵/₈"



9EDB Marvel Absolute Brown Drop Mosaic
27,2x29,7 - 10⁵/₈"x11⁵/₈"



9EHG Marvel Gold Hex Gris-Calacatta
25,1x29 - 9⁷/₈"x11³/₈"



9EHB Marvel Gold Hex Brown-Calacatta
25,1x29 - 9⁷/₈"x11³/₈"



9EHS Marvel Gold Hex Sable-Brown
25,1x29 - 9⁷/₈"x11³/₈"

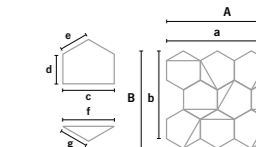

c 9,5 cm - 3³/₄"
d 5,4 cm - 2¹/₈"
e 5,5 cm - 2¹/₈"
f 9,2 cm - 3³/₈"
g 5,3 cm - 2¹/₈"
A 33,9 cm - 13³/₈"
a 29 cm - 11³/₈"
B 27,9 cm - 11"
b 25,1 cm - 9⁷/₈"

• DECOR WITH GOLD INSERT.
DECORO CON INSERTO IN ORO.
Décor avec insert en OR.
Dekor mit Einlage GOLD.
Decoración con aplicación de ORO.
Декор с ЗОЛОТОЙ вставкой.

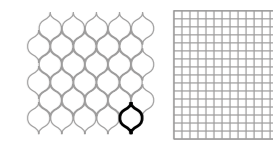

8x5,8 cm
3¹/₄"x2¹/₄"
1,7x1,7 cm
2⁵/₈"x2⁵/₈"



MARVEL EDGE Wall Tiles / Rivestimento

DECOR RANGE / GAMMA DECORI

MARBLE LOOK
WALL TILES



8EGD Marvel Royal Calacatta Gold Vein 1 ■■
40x80 - 15³/₄"x31¹/₂"



8EGE Marvel Royal Calacatta Gold Vein 2 ■■
40x80 - 15³/₄"x31¹/₂"



8EW1 Marvel Imperial White Gold Vein 1 ■■
40x80 - 15³/₄"x31¹/₂"



8EW2 Marvel Imperial White Gold Vein 2 ■■
40x80 - 15³/₄"x31¹/₂"

MARBLE LOOK
WALL TILES



atlas concorde



8ES1 Marvel Elegant Sable Gold Vein 1 ■■
40x80 - 15³/₄"x31¹/₂"



8ES2 Marvel Elegant Sable Gold Vein 2 ■■
40x80 - 15³/₄"x31¹/₂"

• **DECOR WITH GOLD INSERT.**
DECORO CON INSERTO IN ORO.
Décor avec insert en OR.
Dekor mit Einlage GOLD.
Decoración con aplicación de ORO.
Декор с ЗОЛОТОЙ вставкой.

■ **THE GOLD VEIN DECORATION CONSISTS OF FOUR DIFFERENT PATTERNS OF GOLDEN VEINS CONTAINED IN TWO BOXES OF TWO PIECES EACH: GOLD VEIN 1 AND GOLD VEIN 2.**
IL DECORO GOLD VEIN È COMPOSTO DA QUATTRO DIVERSI PATTERN DI VENE DORATE, CONTENUTI IN DUE SCATOLE DA 2 PEZZI CIASCUNA: GOLD VEIN 1 E GOLD VEIN 2.
Les décors Gold Vein sont composés de quatre différents motifs de veines dorées et sont contenus dans deux boîtes de 2 pièces chacune : Gold Vein 1 et Gold Vein 2.
Das Dekor Gold Vein setzt sich aus vier verschiedenen Motiven mit vergoldeten Äderungen zusammen, die in zwei Schachteln mit je 2 Fliesen verpackt sind: Gold Vein 1 und Gold Vein 2.
La decoración Gold Vein consta de cuatro pattern diferentes de vetas doradas, contenidas en dos cajas de 2 piezas cada una: Gold Vein 1 y Gold Vein 2.
Декор Gold Vein включает четыре разных рисунка золотистых прожилок, упакованных в две коробки по 2 штуки в каждой: Gold Vein 1 и Gold Vein 2.



MARVEL

GEMS

PORCELAIN TILES

Porcelain Tiles / Gres Porcellanato

COLOURED BODY PORCELAIN TILES - RECTIFIED MONOCALIBER
GRES PORCELLANATO COLORATO IN MASSA - RETTIFICATO MONOCALIBRO

MATTE SURFACE / SUPERFICIE MATT

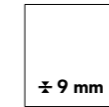

- 60x60 cm** 23⁵/₈"x23⁵/₈"
- ATW3 Marvel Terrazzo White 60x60 Matt
 - ATW4 Marvel Terrazzo Pearl 60x60 Matt
 - ATW5 Marvel Terrazzo Cream 60x60 Matt
 - ATW6 Marvel Terrazzo Grey 60x60 Matt
 - ATW7 Marvel Terrazzo Black 60x60 Matt

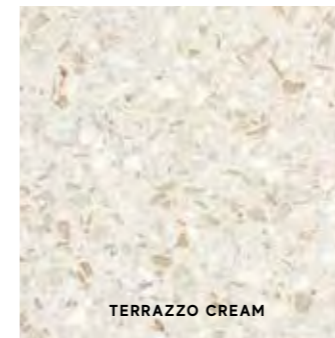





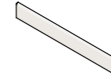
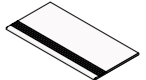
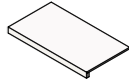
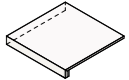

V2
SLIGHT
VARIATION

TRIM TILES / PEZZI SPECIALI

p. 568

UPEC p. 595

				
	Battiscopa 7,2x60 - 2 ⁷ / ₈ "x23 ⁵ / ₈ "	Battiscopa Digitale 4,6x60 - 1 ³ / ₄ "x23 ⁵ / ₈ "	Gradino * 30x60 - 11 ³ / ₄ "x23 ⁵ / ₈ "	Scalino * 33x60 - 13"x23 ⁵ / ₈ "
	Matt	Matt	Matt	Matt
 Terrazzo White	AT9M	AT9H	AUDB	AT9R
 Terrazzo Pearl	AT9N	AT9I	AUDC	AT9T
 Terrazzo Cream	AT9O	AT9J	AUDD	AT9U
 Terrazzo Grey	AT9P	AT9K	AUDE	AT9V
 Terrazzo Black	AT9Q	AT9L	AUDF	AT9W
				AS8Y
				AS8Z
				AS8Ø
				AS81
				AS82

MATTE SURFACE | SUPERFICIE MATT | Surface Mat | Matt oberfläche | Superficie Mate | Матовая поверхность
COLOURED BODY PORCELAIN TILES | GRES PORCELLANATO COLORATO IN MASSA | Grès cérame coloré dans la masse | Durchgefärbtes Feinsteinzeug | Gres porcelánico coloreado en masa | Керамический гранит окрашенный в массе
RECTIFIED MONOCALIBER | RETTIFICATO MONOCALIBRO | Rectifié mono-calibre | Geschliffen einkalibrig | Rettificado monocaltre | Ретифицированный в одном калибре



atlasconcorde

MARVEL

PRO

PORCELAIN&WALL TILES

Porcelain Tiles / Gres Porcellanato

COLOURED BODY PORCELAIN TILES - RECTIFIED MONOCALIBER
GRES PORCELLANATO COLORATO IN MASSA - RETTIFICATO MONOCALIBRO

LARGE SIZES p. 500

Sizes	Thickness	Surface finish
160x320 cm - 63"x126"	± 6 mm	Polished
160x160 cm - 63"x63"	± 6 mm	Polished
120x278 cm - 47 ¹ / ₄ "x109 ¹ / ₂ "	± 6 mm	Polished Matte R9 A
120x240 cm - 47 ¹ / ₄ "x94 ¹ / ₂ "	± 9 mm	Polished
120x120 cm - 47 ¹ / ₄ "x47 ¹ / ₄ "	± 9 mm	Polished Matte R9 A
60x120 cm - 23 ⁵ / ₈ "x47 ¹ / ₄ "	± 9 mm	Polished Matte R9 A
75x150 cm - 29 ¹ / ₂ "x59"	± 9 mm	Polished
75x75 cm - 29 ¹ / ₂ "x29 ¹ / ₂ "	± 9 mm	Polished
45x90 cm - 17 ³ / ₄ "x35 ³ / ₈ "	± 9 mm	Polished Matte R9 A
60x60 cm - 23 ⁵ / ₈ "x23 ⁵ / ₈ "	± 9 mm	Polished Matte R9 A
30x60 cm - 11 ³ / ₄ "x23 ⁵ / ₈ "	± 9 mm	Polished Matte R9 A

Outdoor Paving and Wet Areas

OUTDOOR PAVING p. 554

Sizes	Thickness	Surface finish
30x60 cm - 11 ³ / ₄ "x23 ⁵ / ₈ "	± 9 mm	Textured R11 A+B

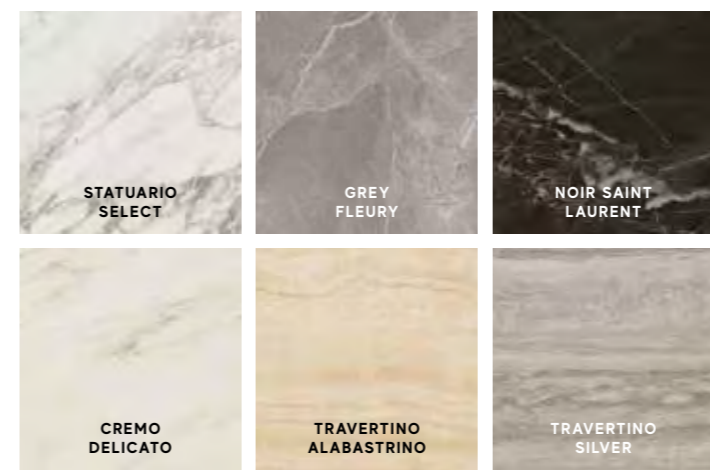

Wall Tiles / Rivestimento

WHITEBODY WALL TILES - RECTIFIED MONOCALIBER
RIVESTIMENTI IN PASTA BIANCA - RETTIFICATO MONOCALIBRO

Sizes	Thickness	Surface finish
50x120 cm - 19 ⁵ / ₈ "x47 ¹ / ₄ "	± 8,5 mm	Shiny
40x80 cm - 15 ³ / ₄ "x31 ¹ / ₂ "	± 8,5 mm	Shiny
30,5x91,5 cm - 12"x36"	± 8,5 mm	Shiny
8x31,5 cm - 3 ¹ / ₈ "x12 ³ / ₈ "	± 8,5 mm	Shiny

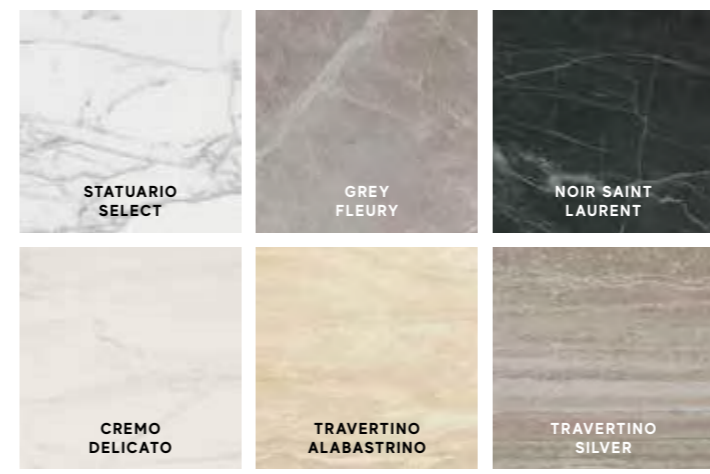

COLOURED BODY PORCELAIN TILES | GRES PORCELLANATO COLORATO IN MASSA | Grés cérame coloré dans la masse | Durchgefärbtes Feinsteinzeug | Gres porcelánico coloreado en masa | Керамический гранит окрашенный в массе
WHITEBODY WALL TILES | RIVESTIMENTI IN PASTA BIANCA | Revêtements en pâte blanche | Weißscherbige Wandfliesen | Revestimientos en pasta blanca | Настенная плитка из белой глины
RECTIFIED MONOCALIBER | RETTIFICATO MONOCALIBRO | Rectifié mono-calibre | Geschliffen einkalibrig | Rectificado monocalibre | Ретицированный в одном калибре

MARVEL PRO Porcelain Tiles / Gres Porcellanato

POLISHED SURFACE / SUPERFICIE LAPPATA



MARBLE LOOK

MARBLE LOOK



160x320 cm 63"x126"
A05W Marvel Crema Delicato 160x320RT Lappato

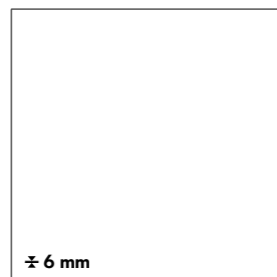

160x160 cm 63"x63"
A052 Marvel Crema Delicato 160x160RT Lappato



120x278 cm 47 1/4"x109 1/2"
A0BN Marvel Statuario Select 120x278 Lappato
A0BO Marvel Crema Delicato 120x278 Lappato
A2RX Marvel Grey Fleury 120x278 Lappato



120x240 cm 47 1/4"x94 1/2"
AY2P Marvel Statuario Select 120x240 Lappato
AY2Q Marvel Crema Delicato 120x240 Lappato

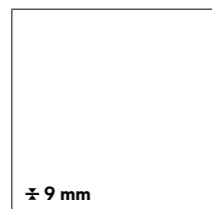

120x120 cm 47 1/4"x47 1/4"
AY2T Marvel Statuario Select 120x120 Lappato
AY2U Marvel Crema Delicato 120x120 Lappato
A210 Marvel Grey Fleury 120x120 Lappato

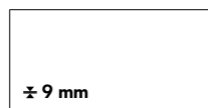

60x120 cm 23 5/8"x47 1/4"
A21N Marvel Crema Delicato 60x120 Lappato
A21M Marvel Grey Fleury 60x120 Lappato

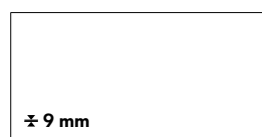

75x150 cm 29 1/2"x59"
AD43 Marvel Statuario Select 75x150 Lappato
AD45 Marvel Crema Delicato 75x150 Lappato
AD47 Marvel Grey Fleury 75x150 Lappato
AD48 Marvel Noir St. Laurent 75x150 Lappato
AD44 Marvel Travertino Alabastrino 75x150 Lappato
AD46 Marvel Travertino Silver 75x150 Lappato

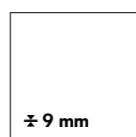

75x75 cm 29 1/2"x29 1/2"
AD4U Marvel Statuario Select 75x75 Lappato
AD4W Marvel Crema Delicato 75x75 Lappato
AD4Y Marvel Grey Fleury 75x75 Lappato
AD4Z Marvel Noir St. Laurent 75x75 Lappato
AD4V Marvel Travertino Alabastrino 75x75 Lappato
AD4X Marvel Travertino Silver 75x75 Lappato

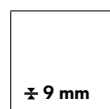

60x60 cm 23 5/8"x23 5/8"
ADUM Marvel Statuario Select 60x60 Lappato
ADUK Marvel Crema Delicato 60x60 Lappato
ADUO Marvel Grey Fleury 60x60 Lappato
ADUP Marvel Noir St. Laurent 60x60 Lappato
ADUL Marvel Travertino Alabastrino 60x60 Lappato
ADUN Marvel Travertino Silver 60x60 Lappato

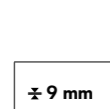

30x60 cm 11 3/4"x23 5/8"
D032 Marvel Statuario Select 30x60 Lappato
D030 Marvel Crema Delicato 30x60 Lappato
D034 Marvel Grey Fleury 30x60 Lappato
D035 Marvel Noir St. Laurent 30x60 Lappato
D031 Marvel Travertino Alabastrino 30x60 Lappato
D033 Marvel Travertino Silver 30x60 Lappato

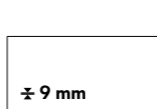

45x90 cm 17 3/4"x35 3/8"
AD49 Marvel Statuario Select 45x90 Lappato
AD5B Marvel Crema Delicato 45x90 Lappato
AD5D Marvel Grey Fleury 45x90 Lappato
AD5E Marvel Noir St. Laurent 45x90 Lappato
AD5A Marvel Travertino Alabastrino 45x90 Lappato
AD5C Marvel Travertino Silver 45x90 Lappato



V2 SLIGHT VARIATION
Crema Delicato,
Travertino Alabastrino,
Travertino Silver,
Noir St. Laurent



V3 MODERATE VARIATION
Statuario Select,
Grey Fleury



STATUARIO SELECT



CREMA DELICATO

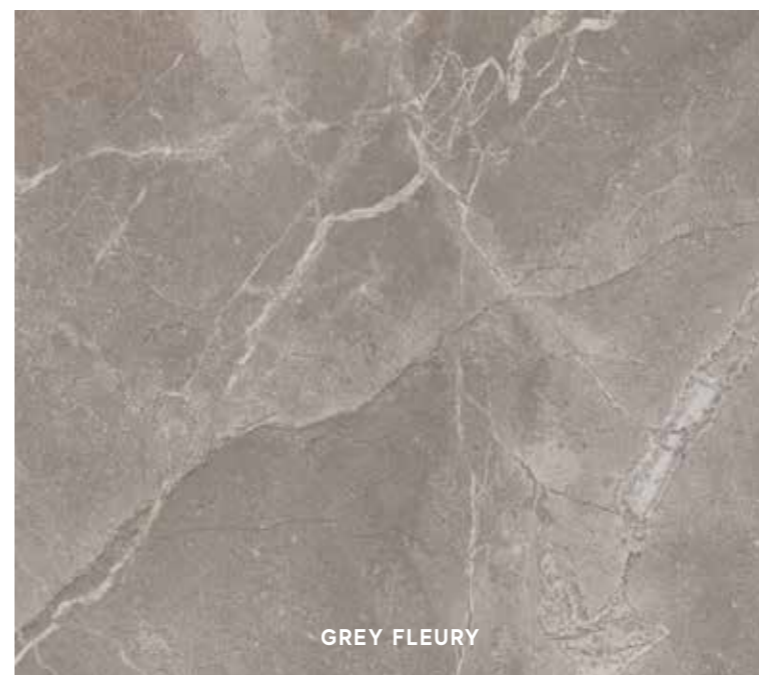

GREY FLEURY



TRAVERTINO ALABASTRINO

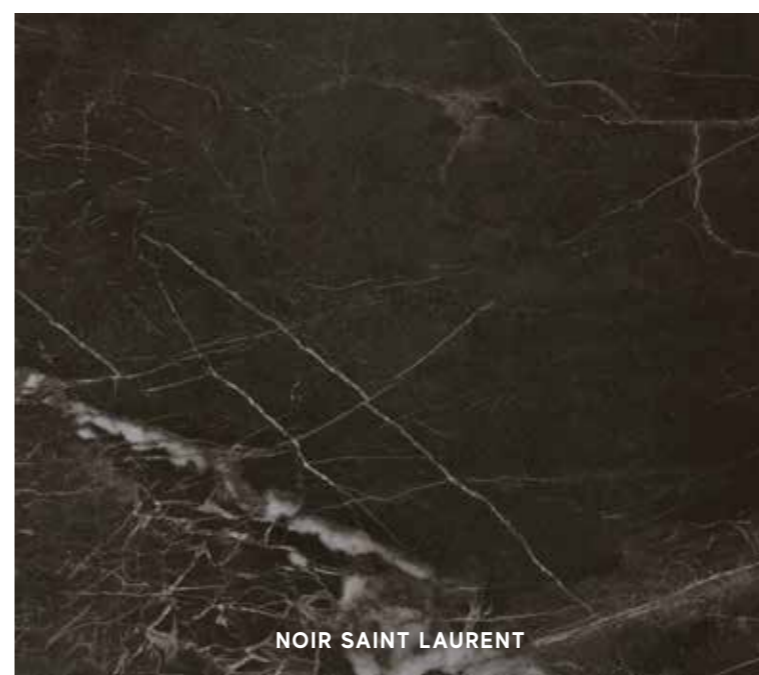

NOIR SAINT LAURENT



TRAVERTINO SILVER

The glossy polished finish is suitable for residential or low-traffic commercial floors, where no anti-slip performance is required, and for walls. The polished glossy surface finish, surprisingly brilliant and bright, features slight irregularities typical of natural marble. The extraordinary brilliance and the easy cleaning of the surface are the result of in-depth research aimed at guaranteeing its durability over time. - If the product is in direct contact with the outdoors, provide devices for absorbing moisture and dirt to prevent scratches. / La finitura lappata lucida è indicata per pavimenti residenziali o commerciali poco sollecitati, laddove non siano richieste prestazioni antiscivolo, e per rivestimenti. La finitura lappata lucida offre una superficie sorprendentemente brillante e specchiante, con lievi irregolarità tipiche dei marmi naturali. La straordinaria lucentezza e l'elevata pulibilità della superficie sono frutto di studi approfonditi e accurate ricerche tecniche volte a garantirne la persistenza nel tempo. - Se il prodotto è a diretto contatto con l'esterno, prevedere dei dispositivi di assorbimento dell'umidità e della sporcizia per prevenire la formazione di graffi.

POLISHED SURFACE | SUPERFICIE LAPPATA | Surface adouci | Geläpopt oberfläche | Superficie brufido | Полированный поверхность

MARVEL PRO Porcelain Tiles / Gres Porcellanato

MATTE SURFACE / SUPERFICIE MATT



120x278 cm 47¹/₄"x109¹/₂"
A2RU Marvel Crema Delicato 120x278 Matt
A2RT Marvel Grey Fleury 120x278 Matt

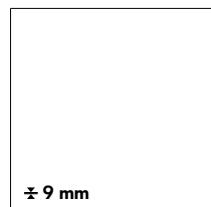

120x120 cm 47¹/₄"x47¹/₄"
A206 Marvel Crema Delicato 120x120 Matt
A205 Marvel Grey Fleury 120x120 Matt

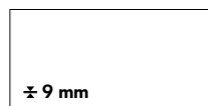

60x120 cm 23⁵/₈"x47¹/₄"
A21G Marvel Crema Delicato 60x120 Matt
A21F Marvel Grey Fleury 60x120 Matt

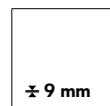

60x60 cm 23⁵/₈"x23⁵/₈"
AVGC Marvel Statuario Select 60x60
AVGD Marvel Crema Delicato 60x60
AVGF Marvel Grey Fleury 60x60
AVGG Marvel Noir St. Laurent 60x60
AVA7 Marvel Travertino Alabastrino 60x60
AVGE Marvel Travertino Silver 60x60



30x60 cm 11³/₄"x23⁵/₈"
D101 Marvel Statuario Select 30x60
D103 Marvel Crema Delicato 30x60
D105 Marvel Grey Fleury 30x60
D106 Marvel Noir St. Laurent 30x60
D102 Marvel Travertino Alabastrino 30x60
D104 Marvel Travertino Silver 30x60

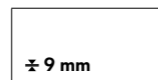

45x90 cm 17³/₄"x35⁵/₈"
ADKV Marvel Statuario Select 45x90
ADKX Marvel Crema Delicato 45x90
ADKZ Marvel Grey Fleury 45x90
ADKØ Marvel Noir St. Laurent 45x90
ADKW Marvel Travertino Alabastrino 45x90
ADKY Marvel Travertino Silver 45x90



TEXTURED SURFACE / SUPERFICIE STRUTTURATA

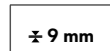

30x60 cm 11³/₄"x23⁵/₈"
D109 Marvel Statuario Select 30x60 Strutturato
D107 Marvel Crema Delicato 30x60 Strutturato
D108 Marvel Grey Fleury 30x60 Strutturato



V2 SLIGHT VARIATION
Crema Delicato,
Travertino Alabastrino,
Travertino Silver,
Noir St. Laurent



V3 MODERATE VARIATION
Statuario Select,
Grey Fleury

MATTE

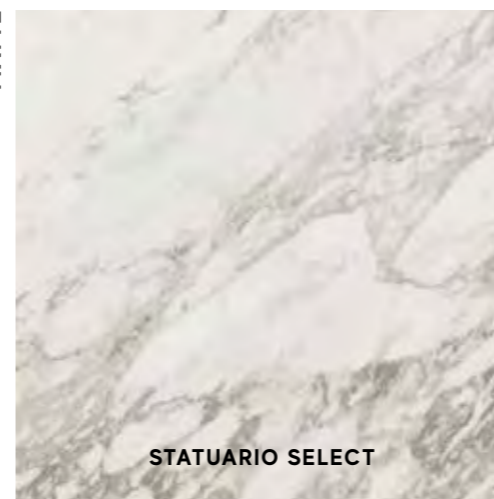

STATUARIO SELECT



GREY FLEURY

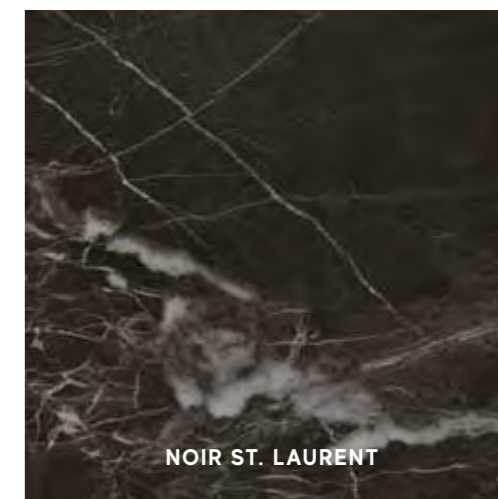

NOIR ST. LAURENT



CREMA DELICATO



TRAVERTINO ALABASTRINO



TRAVERTINO SILVER

TEXTURED



STATUARIO SELECT



CREMA DELICATO



GREY FLEURY

MARVEL PRO Porcelain Tiles / Gres Porcellanato

DECOR RANGE / GAMMA DECORI

MARBLE LOOK

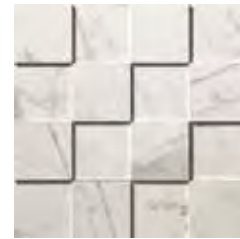

ADP6 Marvel Statuario Select Mosaico 3D *
30x30 - 11³/₄"x11³/₄"



ADQ4 Marvel Grey Fleury Mosaico 3D *
30x30 - 11³/₄"x11³/₄"

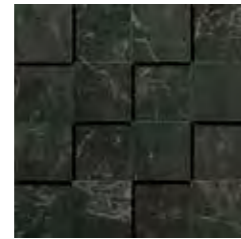

ADQB Marvel Noir St. Laurent Mosaico 3D *
30x30 - 11³/₄"x11³/₄"

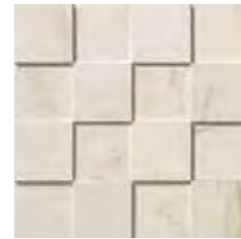

ADP8 Marvel Crema Delicata Mosaico 3D *
30x30 - 11³/₄"x11³/₄"



ADP7 Marvel Travertino Alabastrino Mosaico 3D *
30x30 - 11³/₄"x11³/₄"



ADP9 Marvel Travertino Silver Mosaico 3D *
30x30 - 11³/₄"x11³/₄"



ADVK Marvel Statuario Select Mosaico Esagono Lappato
30x35 - 11³/₄"x13³/₄"



ADVO Marvel Grey Fleury Mosaico Esagono Lappato
30x35 - 11³/₄"x13³/₄"



ADVP Marvel Noir St. Laurent Mosaico Esagono Lappato
30x35 - 11³/₄"x13³/₄"



ADVQ Marvel Mosaico Esagono Multicolor Cold
30x35 - 11³/₄"x13³/₄"
Statuario Select + Grey Fleury + Noir St. Laurent

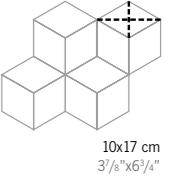

MARBLE LOOK



ADQI Marvel Statuario Select Mosaico Matt
30x30 - 11³/₄"x11³/₄"

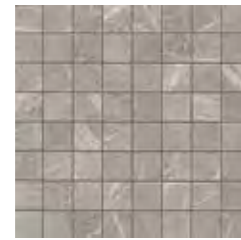

ADQM Marvel Grey Fleury Mosaico Matt
30x30 - 11³/₄"x11³/₄"

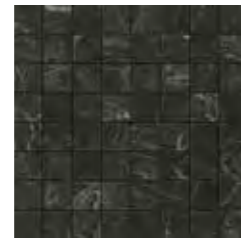

ADQN Marvel Noir St. Laurent Mosaico Matt
30x30 - 11³/₄"x11³/₄"



ADQK Marvel Crema Delicata Mosaico Matt
30x30 - 11³/₄"x11³/₄"



ADQJ Marvel Travertino Alabastrino Mosaico Matt
30x30 - 11³/₄"x11³/₄"



ADQL Marvel Travertino Silver Mosaico Matt
30x30 - 11³/₄"x11³/₄"



ADVM Marvel Crema Delicata Mosaico Esagono Lappato
30x35 - 11³/₄"x13³/₄"



ADVL Marvel Travertino Alabastrino Mosaico Esagono Lappato
30x35 - 11³/₄"x13³/₄"



ADVN Marvel Travertino Silver Mosaico Esagono Lappato
30x35 - 11³/₄"x13³/₄"



ADVR Marvel Mosaico Esagono Multicolor Warm
30x35 - 11³/₄"x13³/₄"
Crema Delicata + Travertino Alabastrino + Noir St. Laurent



ADQC Marvel Statuario Select Mosaico Lappato
30x30 - 11³/₄"x11³/₄"

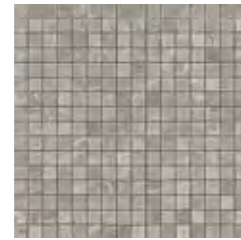

ADQG Marvel Grey Fleury Mosaico Lappato
30x30 - 11³/₄"x11³/₄"

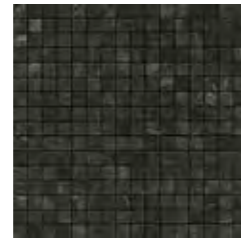

ADQH Marvel Noir St. Laurent Mosaico Lappato
30x30 - 11³/₄"x11³/₄"



ADQE Marvel Crema Delicata Mosaico Lappato
30x30 - 11³/₄"x11³/₄"



ADQD Marvel Travertino Alabastrino Mosaico Lappato
30x30 - 11³/₄"x11³/₄"

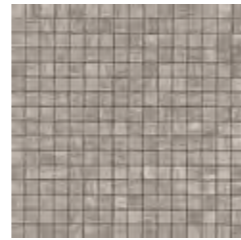

ADQF Marvel Travertino Silver Mosaico Lappato
30x30 - 11³/₄"x11³/₄"



AD5J Marvel Statuario Select Listello 7x75 Lappato
7x75 - 2³/₄"x29¹/₂"



ADVW Marvel Statuario Select Listello 7x60 Lappato
7x60 - 2³/₄"x23⁵/₈"



ADQ2 Marvel Statuario Select Angolo 7x7 Lappato
7x7 - 2³/₄"x2³/₄"

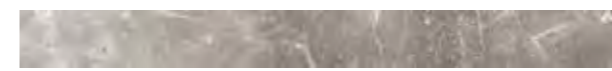

AD5N Marvel Grey Fleury Listello 7x75 Lappato
7x75 - 2³/₄"x29¹/₂"



ADVØ Marvel Grey Fleury Listello 7x60 Lappato
7x60 - 2³/₄"x23⁵/₈"



ADQ6 Marvel Grey Fleury Angolo 7x7 Lappato
7x7 - 2³/₄"x2³/₄"

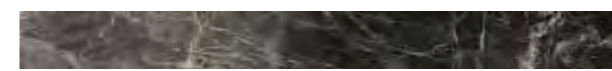

AD5O Marvel Noir St. Laurent Listello 7x75 Lappato
7x75 - 2³/₄"x29¹/₂"



ADV2 Marvel Noir St. Laurent Listello 7x60 Lappato
7x60 - 2³/₄"x23⁵/₈"



ADQ7 Marvel Noir St. Laurent Angolo 7x7 Lappato
7x7 - 2³/₄"x2³/₄"



AD5L Marvel Crema Delicata Listello 7x75 Lappato
7x75 - 2³/₄"x29¹/₂"



ADVY Marvel Crema Delicata Listello 7x60 Lappato
7x60 - 2³/₄"x23⁵/₈"



ADQ4 Marvel Crema Delicata Angolo 7x7 Lappato
7x7 - 2³/₄"x2³/₄"



AD5K Marvel Travertino Alabastrino Listello 7x75 Lappato
7x75 - 2³/₄"x29¹/₂"



ADVX Marvel Travertino Alabastrino Listello 7x60 Lappato
7x60 - 2³/₄"x23⁵/₈"



ADQ3 Marvel Travertino Alabastrino Angolo 7x7 Lappato
7x7 - 2³/₄"x2³/₄"



AD5M Marvel Travertino Silver Listello 7x75 Lappato
7x75 - 2³/₄"x29¹/₂"



ADVZ Marvel Travertino Silver Listello 7x60 Lappato
7x60 - 2³/₄"x23⁵/₈"



ADQ5 Marvel Travertino Silver Angolo 7x7 Lappato
7x7 - 2³/₄"x2³/₄"



ADVA Marvel Mosaico Honeycomb Cold Lappato
30x49 - 11³/₄"x19¹/₄"
Statuario Select + Noir St. Laurent



ADVB Marvel Mosaico Honeycomb Warm Lappato
30x49 - 11³/₄"x19¹/₄"
Crema Delicata + Noir St. Laurent



ADU9 Marvel Mosaico Circle Lappato
30x30 - 11³/₄"x11³/₄"
Crema Delicata + Noir St. Laurent

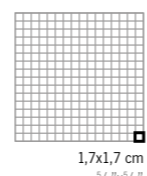
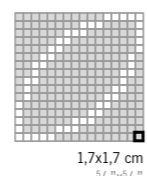
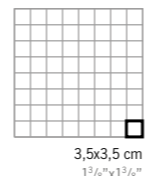
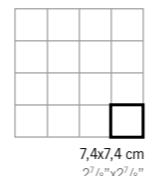

ADRJ Marvel Noir/Crema Greca Mosaico
18,5x30 - 7¹/₄"x11³/₄"
Crema Delicata + Noir St. Laurent

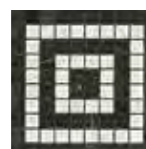

ADRI Marvel Noir/Crema Angolo Mosaico
18,5x18,5 - 7¹/₄"x 7¹/₄"

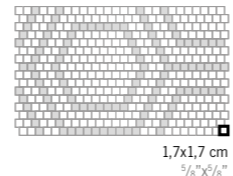
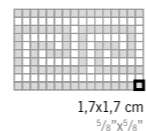
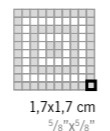

• MULTI-THICKNESS MOSAIC, CLOSE JOINT INSTALLATION WITHOUT GROUTING.
MOSAICO MULTISPESORE. POSA SENZA STUCCATURA A GIUNTO UNITO.
Mosaïque multi-épaisseur, pose sans mastic avec joint nul.
Mosaik mit verschiedenen Stärken, fugenlose Verlegung ohne Mörtel.
Mosaico multiespesor, colocación sin mástique y sin juntas.
Мозаика разной толщины; укладка встык без затирки швов.

THE DECORATION CAN ONLY BE LAID ON THE WALL | IL DECORO SI PUÒ POSARE SOLO A RIVESTIMENTO
Décor uniquement mural | Das Dekor kann nur an der Wand verlegt werden | La decoración se puede colocar únicamente en paredes | Декор может быть уложен только на стену.

MARVEL PRO Porcelain Tiles / Gres Porcellanato

DECOR RANGE / GAMMA DECORI

MARBLE LOOK



AD5F Marvel Statuario Select Macchia Aperta Lappato A - 75x150 - 29 1/2"x59"



AD5G Marvel Statuario Select Macchia Aperta Lappato B - 75x150 - 29 1/2"x59"



AD5H Marvel Grey Fleury Macchia Aperta Lappato A - 75x150 - 29 1/2"x59"



AD5I Marvel Grey Fleury Macchia Aperta Lappato B - 75x150 - 29 1/2"x59"

THE MINIATURES ARE NOT IN PROPORTION.
I MINIMALI NON SONO IN PROPORZIONE.
Les illustrations à échelle réduite ne sont pas proportionnelles.
Die Abbildungen sind nicht verhältnismäßig.
Los miniaturas no están en proporción. n.
Изображения не соблюдают пропорций.

In order to obtain a symmetrical open book installation pattern as reported in the charts below, it is necessary to lay an equal number of tiles of type A and B / Per ottenere la posa simmetrica a macchia aperta riportata negli schemi di posa sottostanti occorre posare un numero uguale di piastrelle di tipo A e di tipo B / Pour obtenir la pose symétrique à livre ouvert indiquée dans les schémas de pose ci-dessous, il est nécessaire de poser une quantité identique de carreaux de type A et de type B / Für die symmetrische bildfurnierte Verlegung, wie im Verlegeschema dargestellt, muss man die gleiche Anzahl von Fliesen vom Typ A und Typ B verlegen / Para obtener la colocación a libro abierto mostrada en los esquemas de colocación de abajo hay que colocar el mismo número de baldosas de tipo A y de tipo B / Для получения симметричного зеркального рисунка укладки, приведенного на схемах ниже, необходимо уложить одинаковое число плиток типа А и типа В

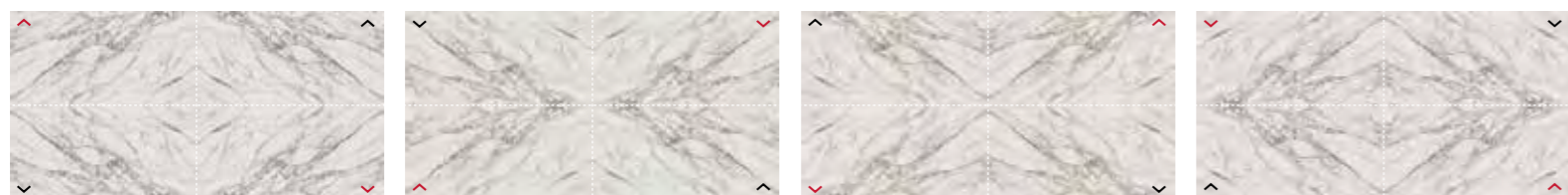

Layout 1 *

Layout 2 *

Layout 3 *

Layout 4 *

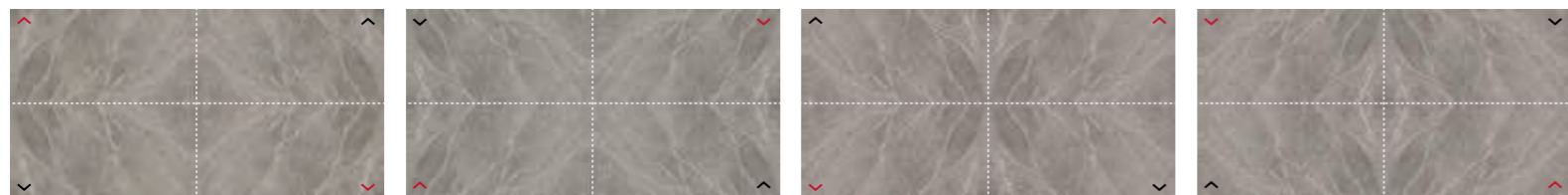

Layout 1 *

Layout 2 *

Layout 3 *

Layout 4 *

*** THE MINIATURES OF THE MULTIFORMATO MODULE ARE NOT IN PROPORTION.**
I MINIMALI NEL MODULO MULTIFORMATO NON SONO IN PROPORZIONE.
Les illustrations à échelle réduite dans le Module Multiformato ne sont pas proportionnelles.
Die Abbildungen im Modul Multiformato sind nicht verhältnismäßig.
Los miniaturas en el Módulo Multiformato no están en proporción.
Изображения Multiformato модуля не соблюдают пропорций.



ADVT Marvel Elegance Angolo Dark * ▲
60x60 - 23 5/8"x23 5/8"

ADVU Marvel Elegance Fascia Dark ▲
60x60 - 23 5/8"x23 5/8"

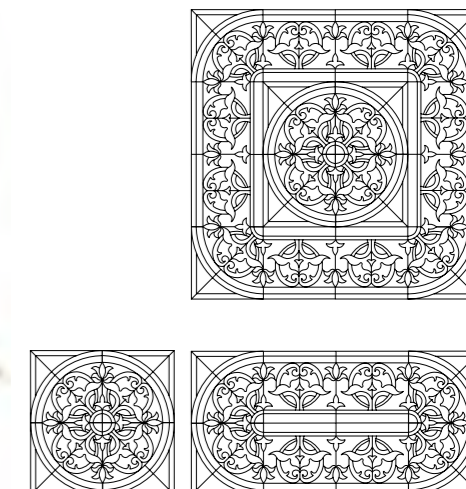

Crema Delicato + Travertino Alabastrino + Grey Fleury + Noir St. Laurent



AD5T Marvel Noir St. Laurent Listello Esagono Lappato
11x86 - 4 3/8"x33 7/8"



AD5Q Etic Rovere Listello Esagono
11x86 - 4 3/8"x33 7/8"



AD5R Etic Noce Listello Esagono
11x86 - 4 3/8"x33 7/8"



▲ **NOT MATCHING WITH SIZES 59x59 CM, 29,5x59 CM.**
NON ABBINABILE AI FORMATI 59x59 CM, 29,5x59 CM.
Ne peut être assorti aux formats 59x59 cm, 29,5x59 cm.
Nicht mit den Formaten 59x59 cm, 29,5x59 cm kombinierbar.
No combinable con los formatos 59x59 cm, 29,5x59 cm.
Не сочетается с форматами 59x59 см, 29,5x59 см.

● **TO BE ORDERED IN MULTIPLES OF 4.**
ORDINABILE IN MULTIPLI DI 4.
Peut être commandé en multiples de 4.
Zum Bestellen als Vielfache von 4.
Es posible efectuar pedidos en múltiplos de 4.
Заказываются в количестве кратном 4.

AD3J Etic Listello Pallissandro Esagono
11x86 - 4 3/8"x33 7/8"

TRIM TILES / PEZZI SPECIALI

p. 568

	Battiscopa		Gradino *	Scalino *		Scalino Angolare		Battiscopa Sag. Scala		Elemento L Str. * 15x60 H. 4 5 7/8"x23 3/8" H. 1 1/8"
	7,2x60 2 7/8"x23 3/8"	7,2x60 2 7/8"x23 3/8"	30x60 11 3/4"x23 3/8"	33x90 13"x35 3/8"	33x60 13"x23 3/8"	DX *	SX *	DX *	SX *	
Statuario Select	ADV3	ADV9	ADW5	ADXB	ADXH	ADXQ		ADXY	ADXZ	ADYD
Crema Delicato	ADV5	ADWB	ADW7	ADXD	ADXJ	ADXR		ADX2	ADX3	ADYE
Travertino Alabastrino	ADV4	ADWA	ADW6	ADXC	ADXI	ADXU	AD XV	ADXØ	ADX1	-
Travertino Silver	ADV6	ADWC	ADW8	ADXE	ADXK	ADXW	ADXX	ADX4	ADX5	-
Grey Fleury	ADV7	ADWD	ADW9	ADXF	ADXL	ADXS		ADX6	ADX7	ADYF
Noir St. Laurent	ADV8	ADWE	ADXA	ADXG	ADXM	ADXT		ADX8	ADX9	-

* THESE PARTS ARE SUPPLIED TO ORDER | I PEZZI SONO DISPONIBILI SU ORDINAZIONE | Les pièces sont disponibles sur commande | Die Teile sind auf Bestellung lieferbar | Las piezas se hacen por encargo | Изготавливаются на заказ

MARBLE LOOK

UPEC p. 595



MARVEL

PRO

WALL TILES

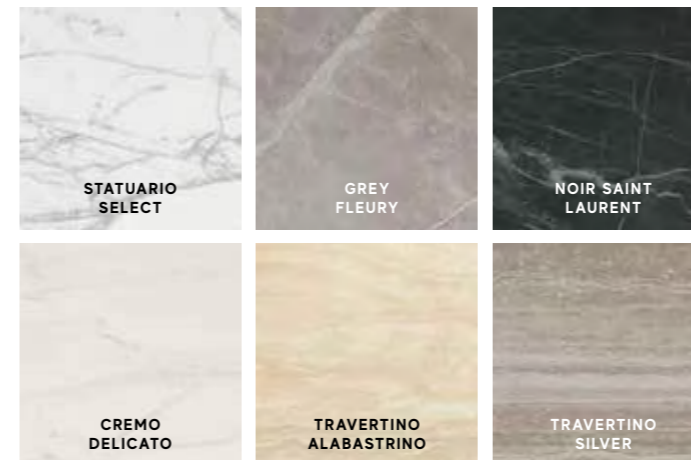

Wall Tiles / Rivestimento

WHITEBODY WALL TILES - RECTIFIED MONOCALIBER
RIVESTIMENTI IN PASTA BIANCA - RETTIFICATO MONOCALIBRO

Sizes	Thickness	Surface finish
50x120 cm - 19 ⁵ / ₈ "x47 ¹ / ₄ "	± 8,5 mm	Shiny
40x80 cm - 15 ³ / ₄ "x31 ¹ / ₂ "	± 8,5 mm	Shiny
30,5x91,5 cm - 12"x36"	± 8,5 mm	Shiny
8x31,5 cm - 3 ¹ / ₈ "x12 ³ / ₈ "	± 8,5 mm	Shiny

DECORATIVE RANGE / GAMMA DECORATIVA



MARVEL PRO Wall Tiles / Rivestimento

SHINY SURFACE / SUPERFICIE LUCIDA



MARBLE LOOK

WALL TILES



A4SW Marvel Statuario 50x120
50x120 - 19⁷/₈"x47¹/₄"

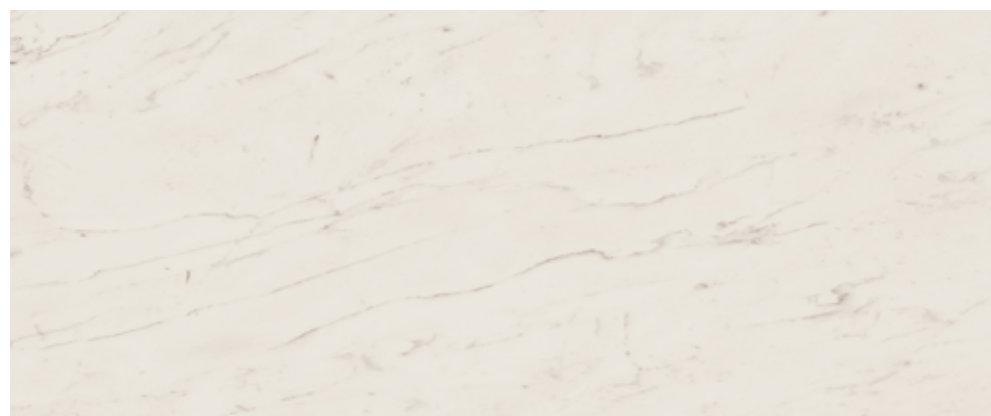

A4SU Marvel Crema Delicata 50x120
50x120 - 19⁵/₈"x47¹/₄"



A4SV Marvel Noir St. Laurent 50x120
50x120 - 19⁵/₈"x47¹/₄"



LMKT Marvel Statuario Select Brick
8x31,5 - 3¹/₈"x12³/₈"



9M4R Marvel Statuario Select 40x80
40x80 - 15³/₄"x31¹/₂"



9M4E Marvel Crema Delicata 40x80
40x80 - 15³/₄"x31¹/₂"



9M4F Marvel Grey Fleury 40x80
40x80 - 15³/₄"x31¹/₂"



9M4L Marvel Travertino Alabastrino 40x80
40x80 - 15³/₄"x31¹/₂"



9M4O Marvel Noir St. Laurent 40x80
40x80 - 15³/₄"x31¹/₂"



9M4Q Marvel Travertino Silver 40x80
40x80 - 15³/₄"x31¹/₂"



V2
SLIGHT
VARIATION
Crema Delicata,
Noir St. Laurent



V3
MODERATE
VARIATION
Statuario Select



V2
SLIGHT
VARIATION
Crema Delicata,
Travertino Alabastrino,
Travertino Silver,
Noir St. Laurent



V3
MODERATE
VARIATION
Statuario Select,
Grey Fleury

MARBLE LOOK

WALL TILES

MARVEL PRO Wall Tiles / Rivestimento

SHINY SURFACE / SUPERFICIE LUCIDA



MARVEL PRO Wall Tiles / Rivestimento

DECOR RANGE / GAMMA DECORI

MARBLE LOOK
WALL TILES

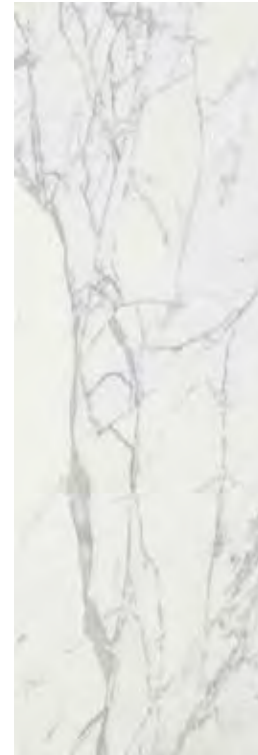

9M3S Marvel Statuario Select 91
30,5x91,5 - 12"x36"



9M3G Marvel Grey Fleury 91
30,5x91,5 - 12"x36"



9M3N Marvel Noir St. Laurent 91
30,5x91,5 - 12"x36"

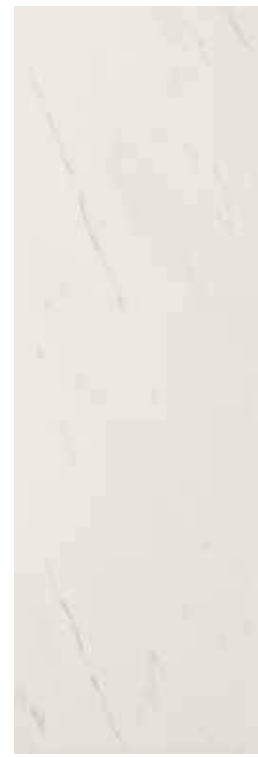

9M3C Marvel Crema Delicata 91
30,5x91,5 - 12"x36"



9M3T Marvel Travertino Alabastrino 91
30,5x91,5 - 12"x36"



9M3V Marvel Travertino Silver 91
30,5x91,5 - 12"x36"

V2
SLIGHT
VARIATION
Crema Delicata,
Travertino Alabastrino,
Travertino Silver,
Noir St. Laurent

V3
MODERATE
VARIATION
Statuario Select,
Grey Fleury

MARBLE LOOK
WALL TILES

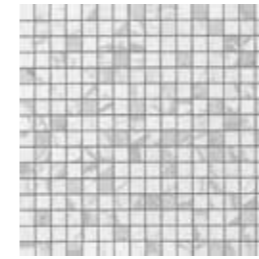

9MVS Marvel Statuario Select Mosaic
30,5x30,5 - 12"x12"

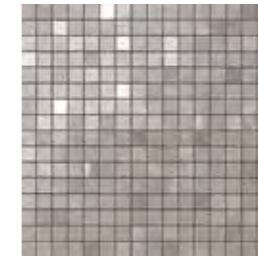

9MVE Marvel Grey Fleury Mosaic
30,5x30,5 - 12"x12"

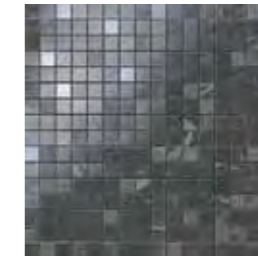

9MVN Marvel Noir St. Laurent Mosaic
30,5x30,5 - 12"x12"

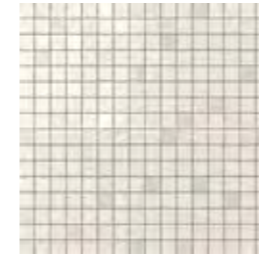
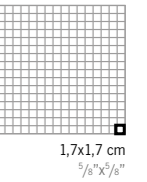

9MVC Marvel Crema Delicata Mosaic
30,5x30,5 - 12"x12"

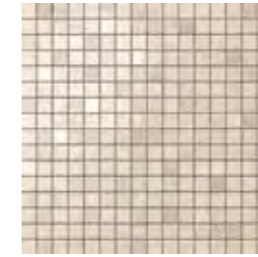

9MVT Marvel Travertino Alabastrino Mosaic
30,5x30,5 - 12"x12"

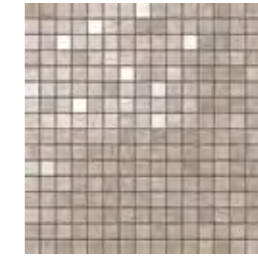

9MVV Marvel Travertino Silver Mosaic
30,5x30,5 - 12"x12"

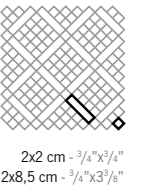

9MVD Marvel Grey Fleury
Diagonal Mosaic
30,5x30,5 - 12"x12"



9MVA Marvel Travertino Alabastrino
Diagonal Mosaic
30,5x30,5 - 12"x12"



9MVB Marvel Travertino Silver
Diagonal Mosaic
30,5x30,5 - 12"x12"



9MVH Marvel Noir Mix
Diagonal Mosaic
30,5x30,5 - 12"x12"

Noir St. Laurent + Statuario Select



9MVF Marvel Crema Mix
Diagonal Mosaic
30,5x30,5 - 12"x12"

Crema Delicata + Noir St. Laurent



9MVP Marvel Grey Fleury Net Mosaic
30,5x30,5 - 12"x12"



9MVM Marvel Travertino Silver Net Mosaic
30,5x30,5 - 12"x12"

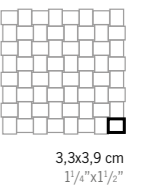

MARVEL PRO Wall Tiles / Rivestimento

DECOR RANGE / GAMMA DECORI



9MBT Marvel Travertino Alabastrino Brocade
30,5x91,5 - 12"x36"



9MBN Marvel Noir St. Laurent Brocade
30,5x91,5 - 12"x36"



8MHG Marvel Grey Fleury Hexagon
40x80 - 15³/₄"x31¹/₂"

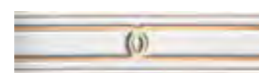

LVGW Marvel Gold White •
7,8x30,5 - 3¹/₈"x12"



LVGB Marvel Gold Black •
7,8x30,5 - 3¹/₈"x12"



AVGW Marvel Gold White A.E. •
7,8x1,2 - 3¹/₈"x¹/₂"



AVGB Marvel Gold Black A.E. •
7,8x1,2 - 3¹/₈"x¹/₂"

• **DECOR WITH GOLD INSERT.**
DECORO CON INSERTO IN ORO.
Décor avec insert en OR.
Dekor mit Einlage GOLD.
Decoración con aplicación de ORO.
Декор с ЗОЛОТОЙ вставкой.



TRIM TILES / PEZZI SPECIALI



LVLS Marvel Statuario Select London
5x30,5 - 2"x12"



AVLS Marvel London A.E.
5x2,5 - 2"x1"



LVLG Marvel Grey Fleury London
5x30,5 - 2"x12"



AVLG Marvel London A.E.
5x2,5 - 2"x1"



LVLN Marvel Noir St. Laurent London
5x30,5 - 2"x12"



AVLN Marvel London A.E.
5x2,5 - 2"x1"

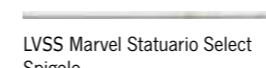

LVSS Marvel Statuario Select Spigolo
0,85x30,5 - 3³/₈"x12"



AVSS Marvel Spigolo A.E.
0,85x0,85 - 3³/₈"x³/₈"



LVSF Marvel Grey Fleury Spigolo
0,85x30,5 - 3³/₈"x12"



AVSG Marvel Spigolo A.E.
0,85x0,85 - 3³/₈"x³/₈"

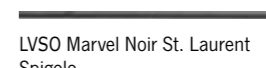

LVSO Marvel Noir St. Laurent Spigolo
0,85x30,5 - 3³/₈"x12"



AVSN Marvel Spigolo A.E.
0,85x0,85 - 3³/₈"x³/₈"



LVAS Marvel Statuario Select Alzata
20x30,5 - 7⁷/₈"x12"



AVAA Marvel Alzata A.E.
1,5x20 - 5⁵/₈"x7⁷/₈"



LVAG Marvel Grey Fleury Alzata
20x30,5 - 7⁷/₈"x12"



AVAF Marvel Alzata A.E.
1,5x20 - 5⁵/₈"x7⁷/₈"



LVAN Marvel Noir St. Laurent Alzata
20x30,5 - 7⁷/₈"x12"



AVAN Marvel Alzata A.E.
1,5x20 - 5⁵/₈"x7⁷/₈"



LVLC Marvel Crema Delicato London
5x30,5 - 2"x12"



AVLC Marvel London A.E.
5x2,5 - 2"x1"



LVLT Marvel Travertino Alabastrino London
5x30,5 - 2"x12"



AVLT Marvel London A.E.
5x2,5 - 2"x1"



LVLV Marvel Travertino Silver London
5x30,5 - 2"x12"



AVLV Marvel London A.E.
5x2,5 - 2"x1"

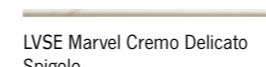

LVSE Marvel Crema Delicato Spigolo
0,85x30,5 - 3³/₈"x12"



AVSC Marvel Spigolo A.E.
0,85x0,85 - 3³/₈"x³/₈"

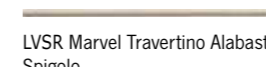

LVSR Marvel Travertino Alabastrino Spigolo
0,85x30,5 - 3³/₈"x12"



AVST Marvel Spigolo A.E.
0,85x0,85 - 3³/₈"x³/₈"

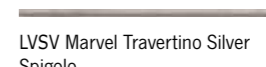

LVSV Marvel Travertino Silver Spigolo
0,85x30,5 - 3³/₈"x12"



AVSV Marvel Spigolo A.E.
0,85x0,85 - 3³/₈"x³/₈"



LVAC Marvel Crema Delicato Alzata
20x30,5 - 7⁷/₈"x12"



AVAC Marvel Alzata A.E.
1,5x20 - 5⁵/₈"x7⁷/₈"



LVAT Marvel Travertino Alabastrino Alzata
20x30,5 - 7⁷/₈"x12"



AVAT Marvel Alzata A.E.
1,5x20 - 5⁵/₈"x7⁷/₈"



LVAV Marvel Travertino Silver Alzata
20x30,5 - 7⁷/₈"x12"



AVAV Marvel Alzata A.E.
1,5x20 - 5⁵/₈"x7⁷/₈"

MARVEL

SHINE

MARBLE LOOK

Marvel Shine pays homage to the white marble of Italian artistic tradition, exploring new surfaces that are unique in their purity, color, and brightness. To further expand the range, **Atlas Concorde sought out the assistance of SAVEMA**, a long-time leader in the marble industry, which offered their experience for the selection of the purest and most precious white marbles to be used as a source of inspiration for this collection.

Marvel Shine rende omaggio al marmo bianco della tradizione artistica italiana, esplorando nuove superfici, uniche per purezza, colore e luminosità. Per ampliare la gamma Marvel, **Atlas Concorde si è avvalsa della collaborazione di SAVEMA**, storica azienda leader nel settore dei marmi, che ha messo a disposizione tutta la sua esperienza per la scelta di marmi bianchi tra i più puri e pregiati, utilizzati come fonte di ispirazione primaria per questa collezione.



MARBLE LOOK



ATLAS CONCORDE SOUGHT OUT THE PUREST MATERIAL DIRECTLY AT THE SOURCE, ACCOMPANIED BY LEADING EXPERTS IN THE FIELD OF NATURAL MARBLES.

ATLAS CONCORDE HA CERCATO ALL'ORIGINE LA MATERIA DI ISPIRAZIONE PIÙ PURA, ACCOMPAGNATA DAI MASSIMI ESPERTI NEL CAMPO DEL MARMO NATURALE.





atlasconcorde

MARVEL

SHINE

PORCELAIN&WALL TILES

Porcelain Tiles / Gres Porcellanato

COLOURED BODY PORCELAIN TILES - RECTIFIED MONOCALIBER
GRES PORCELLANATO COLORATO IN MASSA - RETTIFICATO MONOCALIBRO

LARGE SIZES p. 500



Sizes	Thickness	Surface finish
162x324 cm - 63 ³ / ₄ "x127 ¹ / ₂ " * NON RECTIFIED - NON RETTIFICATO	± 6-12-20* mm	Polished Satin Silk
160x320 cm - 63"x126"	± 6 mm	Polished
160x160 cm - 63"x63"	± 6 mm	Polished
120x278 cm - 47 ¹ / ₄ "x109 ¹ / ₂ "	± 6 mm	Polished Silk
120x240 cm - 47 ¹ / ₄ "x94 ¹ / ₂ "	± 9 mm	Polished
120x120 cm - 47 ¹ / ₄ "x47 ¹ / ₄ "	± 9 mm	Polished Matte R9 A
60x120 cm - 23 ⁵ / ₈ "x47 ¹ / ₄ "	± 9 mm	Polished Matte R9 A
75x150 cm - 29 ¹ / ₂ "x59"	± 9 mm	Polished Silk
75x75 cm - 29 ¹ / ₂ "x29 ¹ / ₂ "	± 9 mm	Polished Silk
37,5x75 cm - 14 ³ / ₄ "x29 ¹ / ₂ "	± 9 mm	Polished
60x60 cm - 23 ⁵ / ₈ "x23 ⁵ / ₈ "	± 9 mm	Polished Silk Matte R10 A+B SOFT TOUCH **
30x60 cm - 11 ³ / ₄ "x23 ⁵ / ₈ "	± 9 mm	Silk

* Natura-vein tech
** On demand - Minimum order quantities must be met

Wall Tiles / Rivestimento

WHITEBODY WALL TILES - RECTIFIED MONOCALIBER
RIVESTIMENTI IN PASTA BIANCA - RETTIFICATO MONOCALIBRO

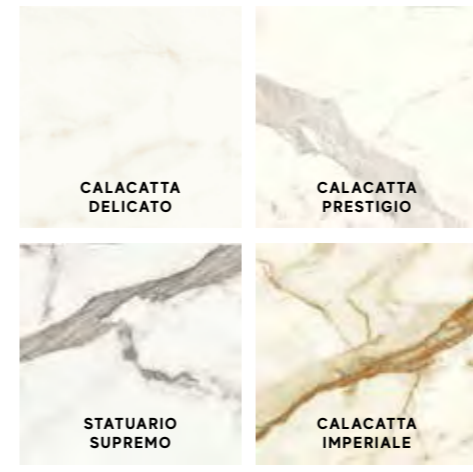

Sizes	Thickness	Surface finish
50x120 cm - 19 ⁵ / ₈ "x47 ¹ / ₄ "	± 8,5 mm	Silk
40x80 cm - 15 ³ / ₄ "x31 ¹ / ₂ "	± 8,5 mm	Shiny

COLOURED BODY PORCELAIN TILES | GRES PORCELLANATO COLORATO IN MASSA | Grés cérame coloré dans la masse | Durchgefärbtes Feinsteinzeug | Gres porcelánico coloreado en masa | Керамический гранит окрашенный в массу
WHITEBODY WALL TILES | RIVESTIMENTI IN PASTA BIANCA | Revêtements en pâte blanche | Weißscherbige Wandfliesen | Revestimientos en pasta blanca | Настенная плитка из белой глины
RECTIFIED MONOCALIBER | RETTIFICATO MONOCALIBRO | Rectifié mono-calibre | Geschliffen einkalibrig | Rectificado monocalibre | Ретифицированный в одном калибре
NON RECTIFIED | NON RETTIFICATO | Non rectifié | Nicht rektifiziert | No rectificada | Неретифицированные

MARVEL SHINE Porcelain Tiles / Gres Porcellanato

POLISHED SURFACE / SUPERFICIE LAPPATA



MARBLE LOOK

MARBLE LOOK



160x320 cm 63"x126"

A4RR Marvel Calacatta Prestigio 160x320 Lappato
A4RS Marvel Statuario Supremo 160x320 Lappato

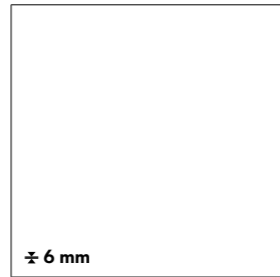

160x160 cm 63"x63"

A4RP Marvel Calacatta Prestigio 160x160 Lappato
A4RQ Marvel Statuario Supremo 160x160 Lappato

atlasPLAN p. 500



POLISHED

162x324 cm 63³/₄"x127¹/₂"

> **NON RECTIFIED** / NON RETTIFICATO

A0XI Calacatta Imperiale Polished ± 12 mm ST *

A0XT Calacatta Imperiale Bookmatch Polished ± 12 mm ST *

A1AE Calacatta Imperiale Polished NATURA VEIN ± 20 mm

A3VR Statuario Supremo Polished NATURA VEIN ± 20 mm



120x278 cm 47¹/₄"x109¹/₂"

A40Y Marvel Calacatta Delicato 120x278 Lappato
A40Z Marvel Calacatta Prestigio 120x278 Lappato
A402 Marvel Calacatta Prestigio 120x278 Bookm A Lp
A403 Marvel Calacatta Prestigio 120x278 Bookm B Lp
A6E0 Marvel Calacatta Prestigio 120x278 Lappato Kit Endless
A400 Marvel Statuario Supremo 120x278 Lappato
A404 Marvel Statuario Supremo 120x278 Bookm A Lp
A405 Marvel Statuario Supremo 120x278 Bookm B Lp
A6EP Marvel Statuario Supremo 120x278 Lappato Kit Endless
A401 Marvel Calacatta Imperiale 120x278 Lappato
A6EQ Marvel Calacatta Imperiale 120x278 Lappato Kit Endless



120x240 cm 47¹/₄"x94¹/₂"

A4RH Marvel Calacatta Delicato 120x240 Lappato
A4RI Marvel Calacatta Prestigio 120x240 Lappato
A4RJ Marvel Statuario Supremo 120x240 Lappato
A4RK Marvel Calacatta Imperiale 120x240 Lappato

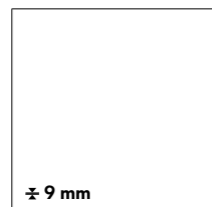

120x120 cm 47¹/₄"x47¹/₄"

A4Q8 Marvel Calacatta Delicato 120x120 Lappato
A4Q9 Marvel Calacatta Prestigio 120x120 Lappato
A4RA Marvel Statuario Supremo 120x120 Lappato
A4RB Marvel Calacatta Imperiale 120x120 Lappato



60x120 cm 23⁵/₈"x47¹/₄"

A4Q0 Marvel Calacatta Delicato 60x120 Lappato
A4Q1 Marvel Calacatta Prestigio 60x120 Lappato
A4Q2 Marvel Statuario Supremo 60x120 Lappato
A4Q3 Marvel Calacatta Imperiale 60x120 Lappato

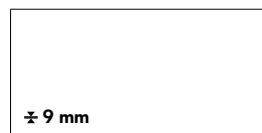

75x150 cm 29¹/₂"x59"

A3W6 Marvel Calacatta Delicato 75x150 Lappato
A3W7 Marvel Calacatta Prestigio 75x150 Lappato
A3W8 Marvel Statuario Supremo 75x150 Lappato
A4PH Marvel Statuario Supremo 75x150 Lp Macchia Aperta
A3W9 Marvel Calacatta Imperiale 75x150 Lappato
A4PI Marvel Calacatta Imperiale 75x150 Lp Macchia Aperta

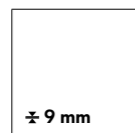

75x75 cm 29¹/₂"x29¹/₂"

A3WX Marvel Calacatta Delicato 75x75 Lappato
A3WY Marvel Calacatta Prestigio 75x75 Lappato
A3WZ Marvel Statuario Supremo 75x75 Lappato
A3W0 Marvel Calacatta Imperiale 75x75 Lappato

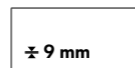

37,5x75 cm 14³/₄"x29¹/₂"

A4RL Marvel Calacatta Delicato 37,5x75 Lappato
A4RM Marvel Calacatta Prestigio 37,5x75 Lappato
A4RN Marvel Statuario Supremo 37,5x75 Lappato
A4RO Marvel Calacatta Imperiale 37,5x75 Lappato

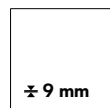

60x60 cm 23⁵/₈"x23⁵/₈"

A4QS Marvel Calacatta Delicato 60x60 Lappato
A4QT Marvel Calacatta Prestigio 60x60 Lappato
A4QU Marvel Statuario Supremo 60x60 Lappato
A4QV Marvel Calacatta Imperiale 60x60 Lappato



V2
SLIGHT
VARIATION
Calacatta Delicato,
Calacatta Prestigio,
Statuario Supremo



V3
MODERATE
VARIATION
Calacatta Imperiale

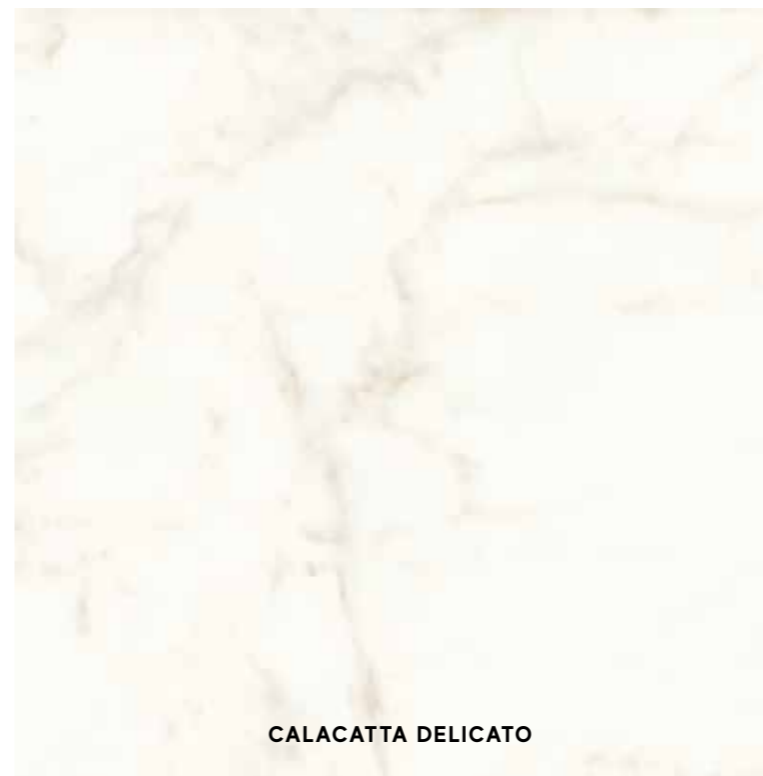

CALACATTA DELICATO

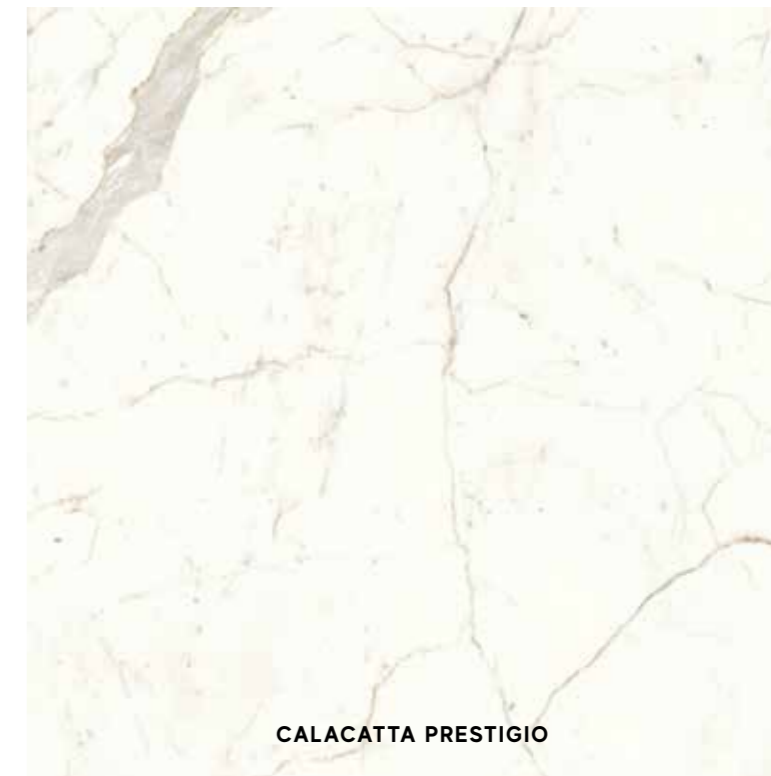

CALACATTA PRESTIGIO

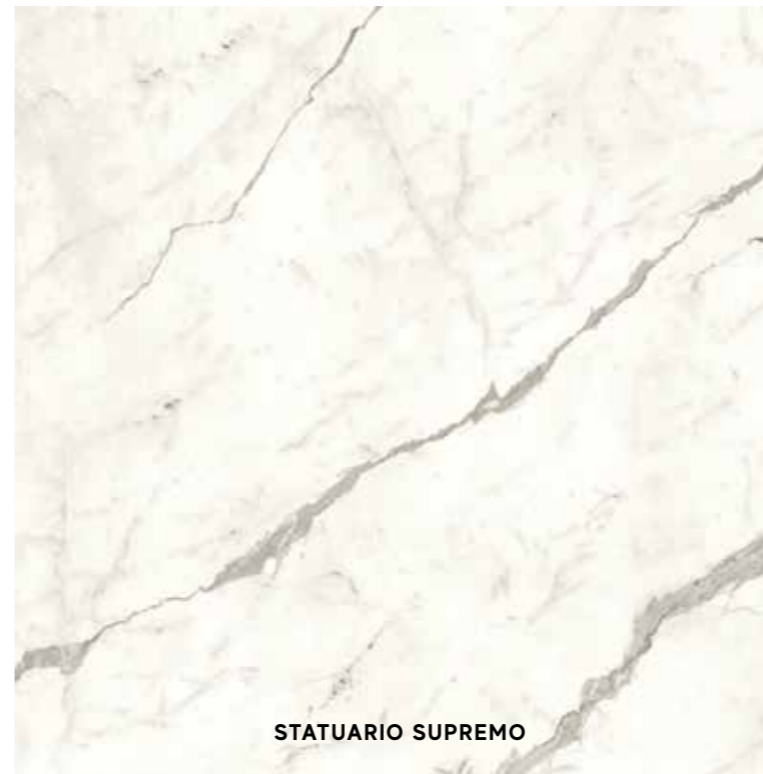

STATUARIO SUPREMO



CALACATTA IMPERIALE

Polished and silk finishes are recommended for low-stress residential or commercial floors where anti-slip performance is not required. The polished glossy surface finish, surprisingly brilliant and bright, features slight irregularities typical of natural marble. The surface's shine and superior ease of cleaning are the result of in-depth studies and extensive technical research aimed at ensuring its durability over time. If the product is in direct contact with the outside, use moisture and dirt absorption devices to prevent scratches. / Le finiture lappata e silk sono indicate per pavimenti residenziali o commerciali poco sollecitati, laddove non siano richieste prestazioni antiscivolo. La finitura lappata lucida offre una superficie sorprendentemente brillante e specchiante, con lievi irregolarità tipiche dei marmi naturali. La lucentezza e l'elevata facilità di pulizia della superficie sono frutto di studi approfonditi e accurate ricerche tecniche volte a garantirne la persistenza nel tempo. Se il prodotto è a diretto contatto con l'esterno, prevedere dei dispositivi di assorbimento dell'umidità e dello sporco per prevenire la formazione di graffi.

POLISHED SURFACE | SUPERFICIE LAPPATA | Surface adouci | Gelläppt oberfläche | Superficie brufiido | Полуполированный поверхность

* **WITH FIBERGLASS MESH** | VERSIONE STUOIATA | Version à nattes | Ausführung mit Glasfasermatte | Versión con malla | С упрочнением из стекловолокна
NON RECTIFIED | NON RETTIFICATO | Non rectifié | Nicht rektifiziert | No rectificada | Неретифицированные

MARVEL SHINE Porcelain Tiles / Gres Porcellanato

SILK SURFACE / SUPERFICIE SILK



120x278 cm 47¹/₄"x109¹/₂"

- A406 Marvel Calacatta Prestigio 120x278 Silk
- A6ER Marvel Calacatta Prestigio 120x278 Silk Kit Endless
- A407 Marvel Statuario Supremo 120x278 Silk
- A6ES Marvel Statuario Supremo 120x278 Silk Kit Endless



75x150 cm 29¹/₂"x59"

- A3XA Marvel Calacatta Delicato 75x150 Silk
- A3XB Marvel Calacatta Prestigio 75x150 Silk
- A3XC Marvel Statuario Supremo 75x150 Silk
- A3XD Marvel Calacatta Imperiale 75x150 Silk

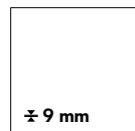

75x75 cm 29¹/₂"x29¹/₂"

- A3W1 Marvel Calacatta Delicato 75x75 Silk
- A3W2 Marvel Calacatta Prestigio 75x75 Silk
- A3W4 Marvel Statuario Supremo 75x75 Silk
- A3W5 Marvel Calacatta Imperiale 75x75 Silk

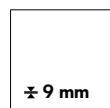

60x60 cm 23⁵/₈"x23⁵/₈"

- A5TC Marvel Calacatta Delicato 60x60 Silk
- A5TD Marvel Calacatta Prestigio 60x60 Silk
- A5TE Marvel Statuario Supremo 60x60 Silk
- A5TF Marvel Calacatta Imperiale 60x60 Silk

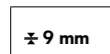

30x60 cm 11³/₄"x23⁵/₈"

- A5TG Marvel Calacatta Delicato 30x60 Silk
- A5TH Marvel Calacatta Prestigio 30x60 Silk
- A5TI Marvel Statuario Supremo 30x60 Silk
- A5TJ Marvel Calacatta Imperiale 30x60 Silk

atlasPLAN p. 500



SILK / SILK
SATIN / SATIN
162x324 cm 63³/₄"x127¹/₂"
> **NON RECTIFIED / NON RETTIFICATO**

- A4T3 Calacatta Delicato Silk ± 12 mm ST *
- A4T0 Calacatta Prestigio Silk ± 12 mm ST *
- A4T1 Calacatta Prestigio Bookmatch Silk ± 12 mm ST *
- A4TX Statuario Supremo Silk ± 12 mm ST *
- A4I3 Statuario Supremo Satin ± 12 mm ST *
- A4TY Statuario Supremo Bookmatch Silk ± 12 mm ST *
- A4I5 Statuario Supremo Bookmatch Satin ± 12 mm ST *
- A3VQ Statuario Supremo Silk NATURA VEIN ± 20 mm
- A2YG Calacatta Imperiale Silk ± 6 mm ST *
- A2YH Calacatta Imperiale Bookmatch Silk ± 6 mm ST *
- A0XV Calacatta Imperiale Silk ± 12 mm ST *
- A0XX Calacatta Imperiale Bookmatch Silk ± 12 mm ST *
- A3M9 Calacatta Imperiale Satin ± 12 mm ST *
- A4I1 Calacatta Imperiale Bookmatch Satin ± 12 mm ST *
- A16W Calacatta Imperiale Silk NATURA VEIN ± 20 mm

MATTE SURFACE / SUPERFICIE MATT

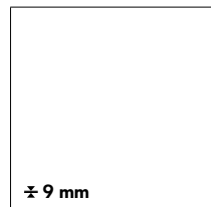

120x120 cm 47¹/₄"x47¹/₄"

- A4Q4 Marvel Calacatta Delicato 120x120 Matt
- A4Q5 Marvel Calacatta Prestigio 120x120 Matt
- A4Q6 Marvel Statuario Supremo 120x120 Matt
- A4Q7 Marvel Calacatta Imperiale 120x120 Matt

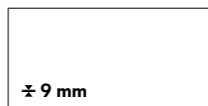

60x120 cm 23⁵/₈"x47¹/₄"

- A4QW Marvel Calacatta Delicato 60x120 Matt
- A4QX Marvel Calacatta Prestigio 60x120 Matt
- A4QY Marvel Statuario Supremo 60x120 Matt
- A4QZ Marvel Calacatta Imperiale 60x120 Matt

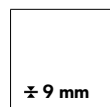

60x60 cm 23⁵/₈"x23⁵/₈"

- A4Q0 Marvel Calacatta Delicato 60x60 R10B Soft Touch
- A4QQ Marvel Calacatta Prestigio 60x60 R10B Soft Touch
- A4QR Marvel Statuario Supremo 60x60 R10B Soft Touch
- A4QP Marvel Calacatta Imperiale 60x60 R10B Soft Touch



V3
MODERATE
VARIATION
Calacatta Imperiale



V2
SLIGHT
VARIATION
Calacatta Delicato,
Calacatta Prestigio,
Statuario Supremo

MATTE / SILK

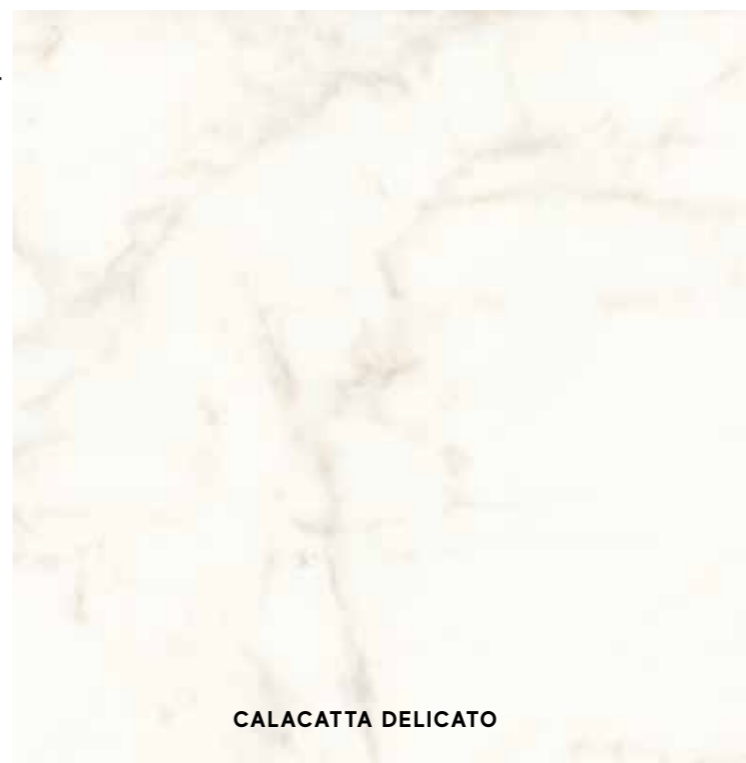

CALACATTA DELICATO

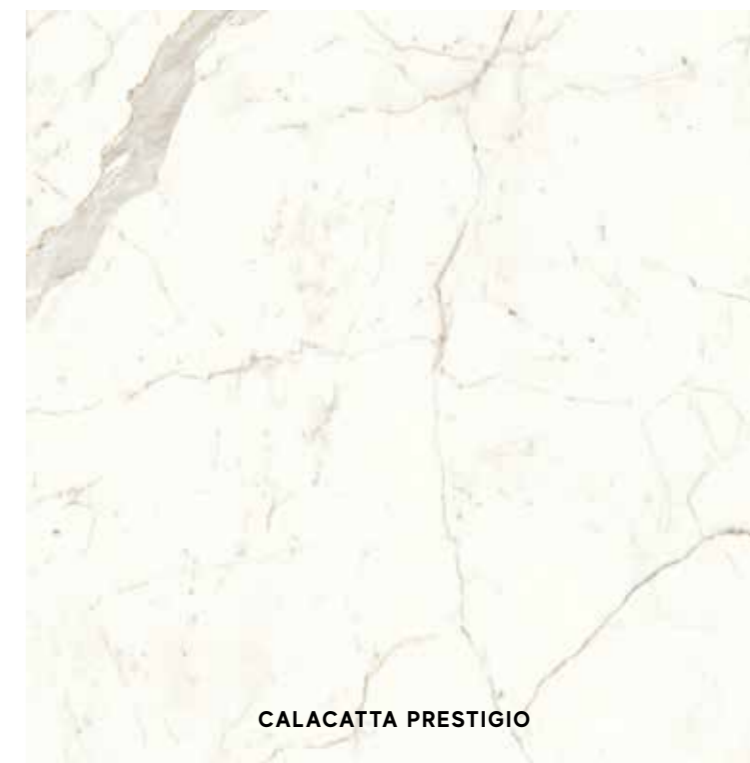

CALACATTA PRESTIGIO

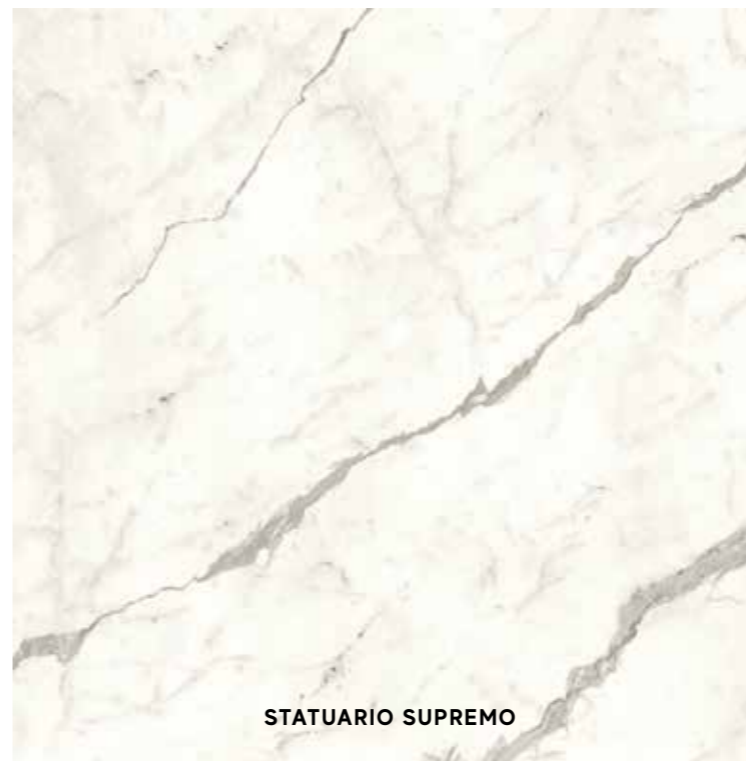

STATUARIO SUPREMO



CALACATTA IMPERIALE

Polished and silk finishes are recommended for low-stress residential or commercial floors where anti-slip performance is not required. The polished glossy surface finish, surprisingly brilliant and bright, features slight irregularities typical of natural marble. The surface's shine and superior ease of cleaning are the result of in-depth studies and extensive technical research aimed at ensuring its durability over time. If the product is in direct contact with the outside, use moisture and dirt absorption devices to prevent scratches. / Le finiture lappata e silk sono indicate per pavimenti residenziali o commerciali poco sollecitati, laddove non siano richieste prestazioni antiscivolo. La finitura lappata lucida offre una superficie sorprendentemente brillante e specchiante, con lievi irregolarità tipiche dei marmi naturali. La lucentezza e l'elevata facilità di pulizia della superficie sono frutto di studi approfonditi e accurate ricerche tecniche volte a garantirne la persistenza nel tempo. Se il prodotto è a diretto contatto con l'esterno, prevedere dei dispositivi di assorbimento dell'umidità e dello sporco per prevenire la formazione di graffi.

MATTE SURFACE | SUPERFICIE MATT | Surface Mat | Matt oberfläche | Superficie Mate | Матовая поверхность
SILK SURFACE | SUPERFICIE SILK | Surface Silk | Oberfläche Silk | Superficie Silk | Поверхность Silk

* **WITH FIBERGLASS MESH** | VERSIONE STUOIATA | Version à nattes | Ausführung mit Glasfasermatte | Version con malla | С упрочнением из стекловолокну
NON RECTIFIED | NON RETTIFICATO | Non rectifié | Nicht rektifiziert | No rectificada | Неретифицированные

MARVEL SHINE Porcelain Tiles / Gres Porcellanato

MACCHIA APERTA

A4PI Marvel Calacatta Imperiale 75x150 Lappato Macchia Aperta - 75x150 - 29 1/2"x59"

MARBLE LOOK

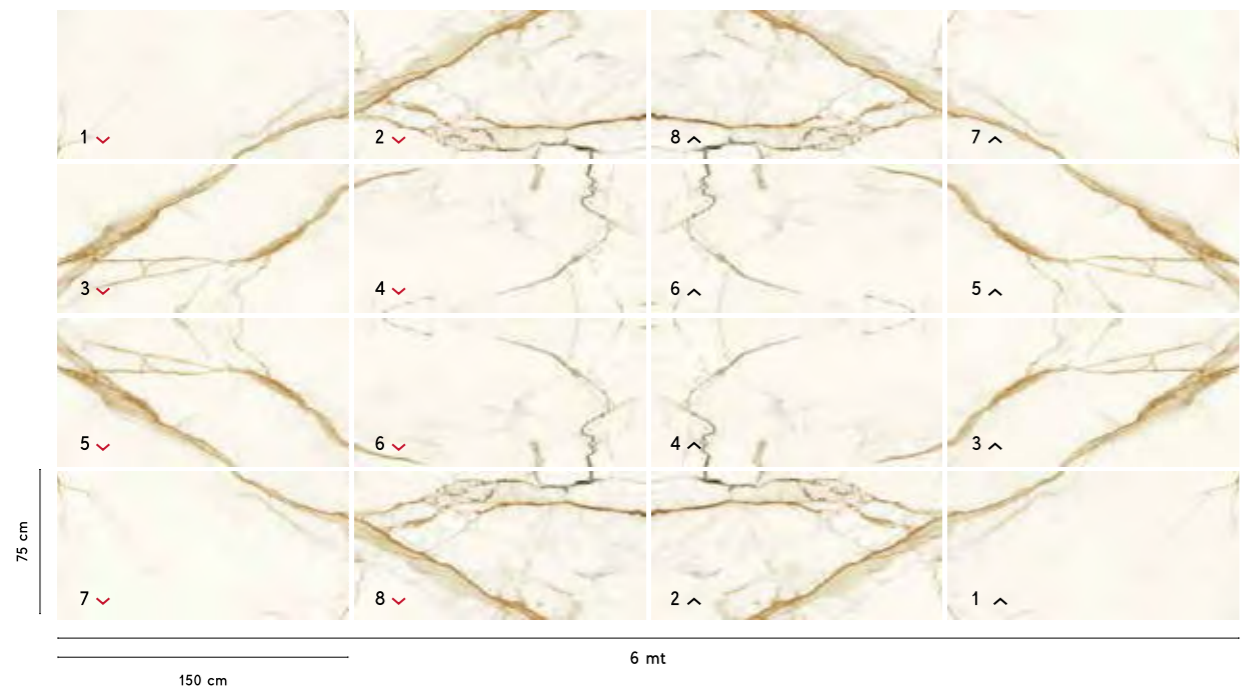

Layout 1

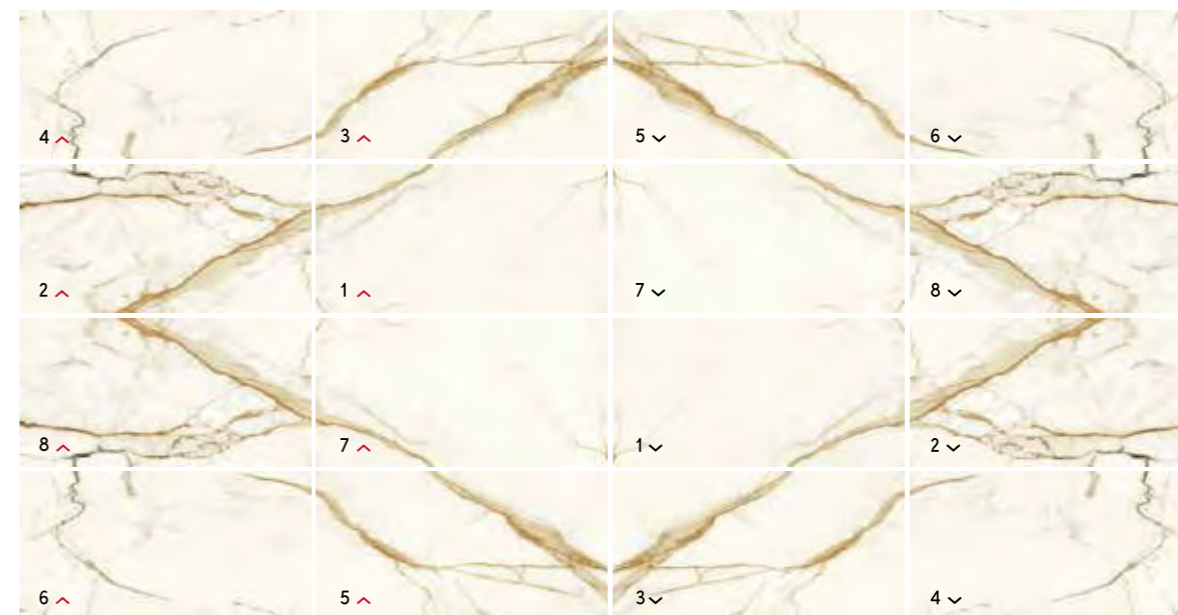

Layout 3

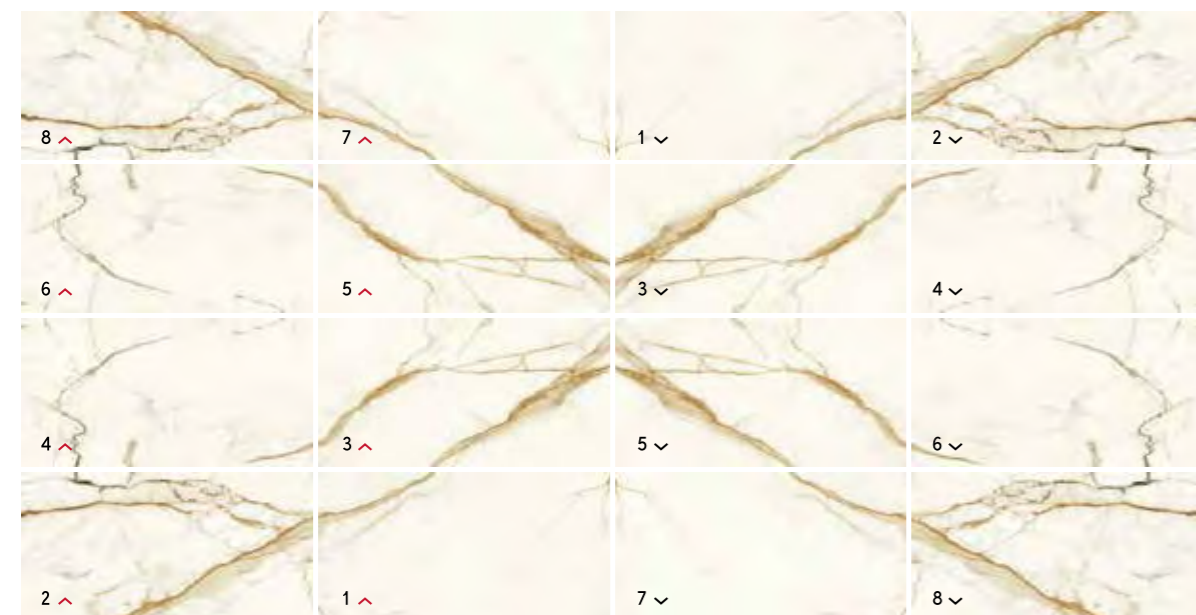

Layout 2

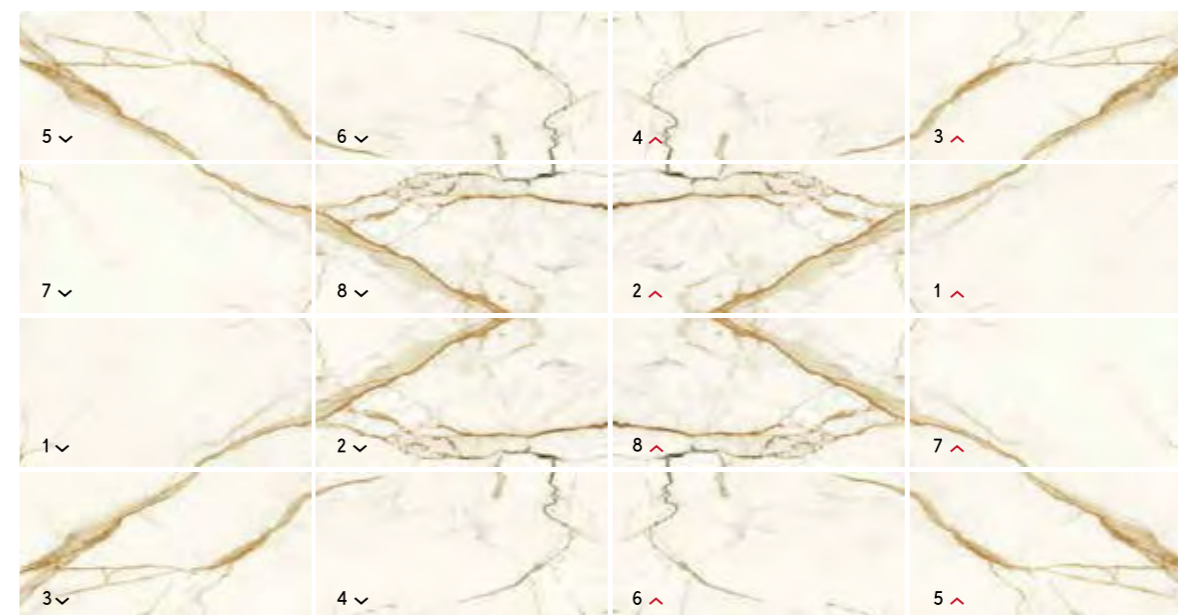

Layout 4

The collection allows creating an open vein measuring 6 m x 3 m (16 75x150 slabs) ideal for large rooms where you can enhance the entire interior design. The junction between the graphics that make up the open vein is not geometrically perfect but imitates the natural irregularity of the open veins of natural marble products. The code "polished open vein" corresponds to a pallet composed of 16 tiles in the 75x150 cm (8+8) format that make up the entire open vein. A number is printed on the edge of each tile (see laying diagram). / La collezione permette di creare una macchia aperta di dimensioni 6 m x 3 m (16 facce di 75x150) ideale per ambienti ampi nei quali poter valorizzare l'intera composizione. La giunzione tra le grafiche che compongono la macchia aperta non è geometricamente perfetta ma imita la naturale irregolarità delle macchie aperte dei prodotti in marmo naturale. Il codice "lappato macchia aperta" corrisponde ad un pallet composto da 16 piastrelle in formato 75cmx150cm (8+8) che compongono l'intera macchia aperta. Sulla costa di ciascuna piastrella è stampato il numero corrispondente (vedi schema di posa). / La collection permet de créer une tache ouverte de 6 m x 3 m (16 faces de 75x150) idéale pour les grandes pièces où l'on peut mettre en valeur l'ensemble de la composition. La jonction entre les graphismes qui composent la tache ouverte n'est pas géométriquement parfaite mais imite l'irrégularité naturelle des taches ouvertes des produits en marbre naturel. Le code "lappato macchia aperta" (tache ouverte rodée) correspond à une palette composée de 16 carreaux au format 75cmx150cm (8+8) qui constituent la totalité de la tache ouverte. Le numéro correspondant est imprimé sur le bord de chaque carreau (voir schéma de pose). / Die Kollektion erlaubt die Bildung einer Spiegeloptik mit den Abmessungen 6 m x 3 m (16 verschiedenen Oberflächen 75 x 150). Ideal in weitläufigen Räumen, in denen die Komposition optimal zur Geltung gebracht werden kann. Der Anschluss zwischen den einzelnen Grafikbildern, die den Spiegeleffekt bilden, ist geometrisch nicht perfekt, sondern empfindet die natürliche Unregelmäßigkeit der mit Naturmarmor erzielten Spiegeloptik nach. Die Artikelbezeichnung „geläpft gespiegelt“ entspricht einer Palette mit 16 Fliesen im Format 75 cm x 150 cm (8+8), die das gesamte, gespiegelte Motiv bilden. Jede Fliese ist an der Seite nummeriert (siehe Verlegeplan). / La colección permite crear una mancha abierta de 6 m x 3 m (16 caras de 75x150) ideal para ambientes amplios donde se puede realzar toda la composición. La unión entre los gráficos que componen la mancha abierta no es geométricamente perfecta, sino que imita la natural irregularidad de las manchas abiertas de los productos de mármol natural. El código «lapeado mancha abierta» corresponde a una paleta compuesta de 16 baldosas de formato 75cmx150cm (8+8) que componen toda la mancha abierta. El número correspondiente está impreso en el borde de cada baldosa (ver diagrama de colocación). / Коллекция позволяет создавать облицовку с симметричным зеркальным рисунком 6 м x 3 м (16 плит 75x150). Данная композиция максимально раскрывает свой потенциал в больших помещениях. Стык между плитами, которые образуют симметричный рисунок, не является геометрически совершенным, а имитирует естественную неровность аналогичных рисунков, составляемых из плит природного мрамора. Код «лапатированный с симметричным зеркальным рисунком» соответствует поддону, состоящему из 16 плит формата 75 см x 150 см (8+8), из которых складывается данный симметричный рисунок. На торце каждой из плит напечатан соответствующий номер (см. схему укладки).

THE MINIATURES ARE NOT IN PROPORTION.
 I MINIMALI NON SONO IN PROPORZIONE.
 Les illustrations à échelle réduite ne sont pas proportionnelles.
 Die Abbildungen sind nicht verhältnismäßig.
 Los miniaturas no están en proporción. n.
 Изображения не соблюдают пропорции.

MARBLE LOOK

MARVEL SHINE Porcelain Tiles / Gres Porcellanato

MACCHIA APERTA

A4PH Marvel Statuario Supremo 75x150 Lappato Macchia Aperta - 75x150 - 29 1/2"x59"

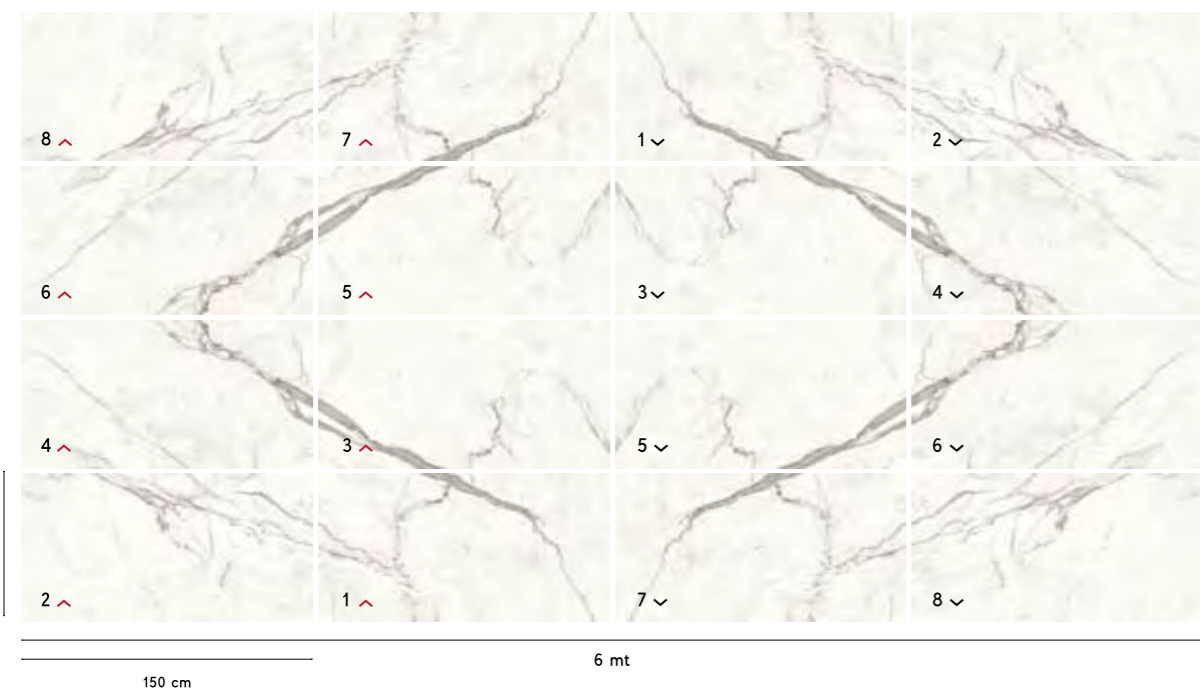

Layout 1

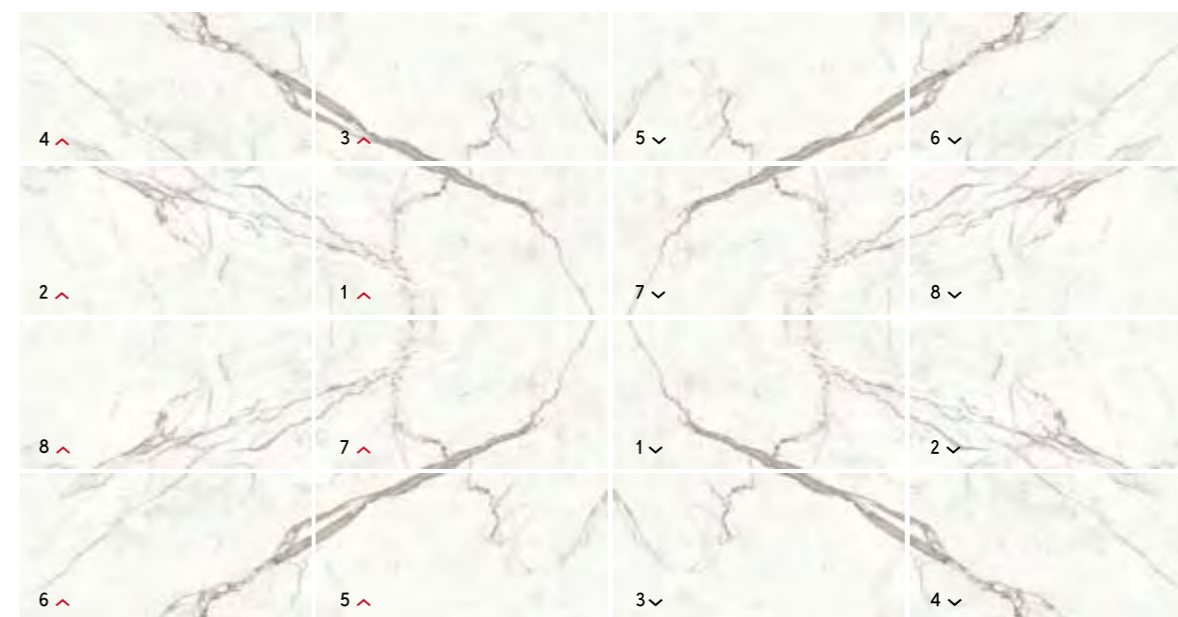

Layout 3

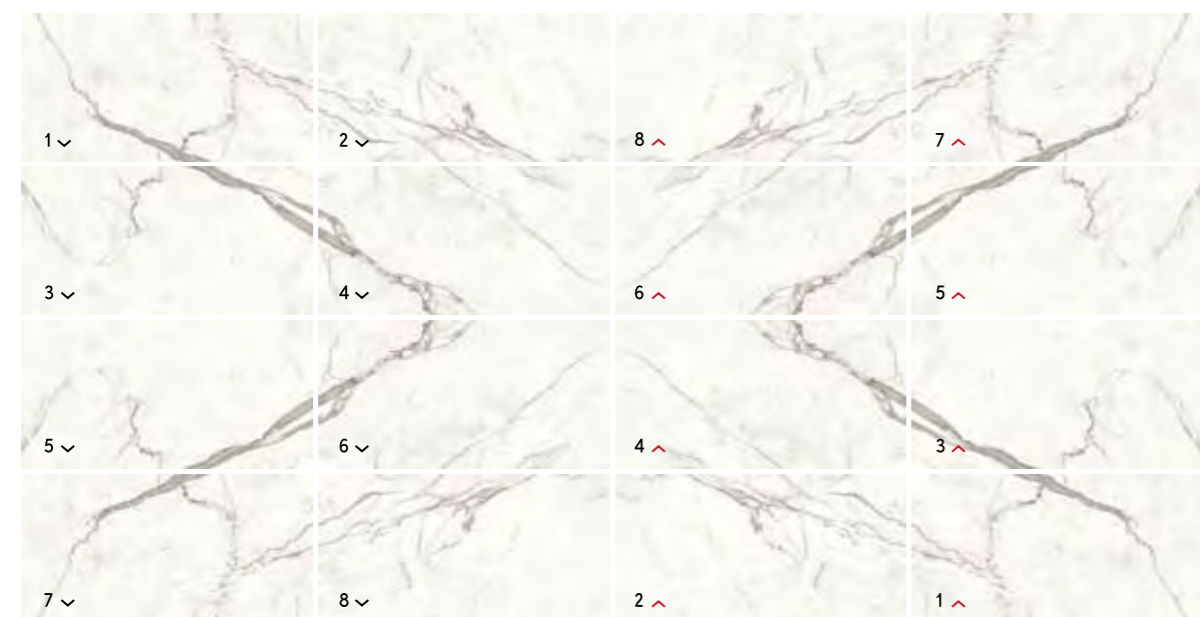

Layout 2



Layout 4

The collection allows creating an open vein measuring 6 m x 3 m (16 75x150 slabs) ideal for large rooms where you can enhance the entire interior design. The junction between the graphics that make up the open vein is not geometrically perfect but imitates the natural irregularity of the open veins of natural marble products. The code "polished open vein" corresponds to a pallet composed of 16 tiles in the 75x150 cm (8+8) format that make up the entire open vein. A number is printed on the edge of each tile (see laying diagram). / La collezione permette di creare una macchia aperta di dimensioni 6 m x 3 m (16 facce di 75x150) ideale per ambienti ampi nei quali poter valorizzare l'intera composizione. La giunzione tra le grafiche che compongono la macchia aperta non è geometricamente perfetta ma imita la naturale irregolarità delle macchie aperte dei prodotti in marmo naturale. Il codice "lappato macchia aperta" corrisponde ad un pallet composto da 16 piastrelle in formato 75cmx150cm (8+8) che compongono l'intera macchia aperta. Sulla costa di ciascuna piastrella è stampato il numero corrispondente (vedi schema di posa). / La collection permet de créer une tache ouverte de 6 m x 3 m (16 faces de 75x150) idéale pour les grandes pièces où l'on peut mettre en valeur l'ensemble de la composition. La jonction entre les graphismes qui composent la tache ouverte n'est pas géométriquement parfaite mais imite l'irrégularité naturelle des taches ouvertes des produits en marbre naturel. Le code "lappato macchia aperta" (tache ouverte rodée) correspond à une palette composée de 16 carreaux au format 75cmx150cm (8+8) qui constituent la totalité de la tache ouverte. Le numéro correspondant est imprimé sur le bord de chaque carreau (voir schéma de pose). / Die Kollektion erlaubt die Bildung einer Spiegeloptik mit den Abmessungen 6 m x 3 m (16 verschiedenen Oberflächen 75 x 150). Ideal in weitläufigen Räumen, in denen die Komposition optimal zur Geltung gebracht werden kann. Der Anschluss zwischen den einzelnen Grafikbildern, die den Spiegeleffekt bilden, ist geometrisch nicht perfekt, sondern empfindet die natürliche Unregelmäßigkeit der mit Naturmarmor erzielten Spiegeloptik nach. Die Artikelbezeichnung „geläpft gespiegelt“ entspricht einer Palette mit 16 Fliesen im Format 75 cm x 150 cm (8+8), die das gesamte, gespiegelte Motiv bilden. Jede Fliese ist an der Seite nummeriert (siehe Verlegeplan). / La colección permite crear una mancha abierta de 6 m x 3 m (16 caras de 75x150) ideal para ambientes amplios donde se puede realizar toda la composición. La unión entre los gráficos que componen la mancha abierta no es geométricamente perfecta, sino que imita la natural irregularidad de las manchas abiertas de los productos de mármol natural. El código «lapeado mancha abierta» corresponde a una paleta compuesta de 16 baldosas de formato 75cmx150cm (8+8) que componen toda la mancha abierta. El número correspondiente está impreso en el borde de cada baldosa (ver diagrama de colocación). / Коллекция позволяет создавать облицовку с симметричным зеркальным рисунком 6 м x 3 м (16 плит 75x150). Данная композиция максимально раскрывает свой потенциал в больших помещениях. Стык между плитами, которые образуют симметричный рисунок, не является геометрически совершенным, а имитирует естественную неровность аналогичных рисунков, составляемых из плит природного мрамора. Код «лапатированный с симметричным зеркальным рисунком» соответствует поддону, состоящему из 16 плит формата 75 см x 150 см (8+8), из которых складывается данный симметричный рисунок. На торце каждой из плит напечатан соответствующий номер (см. схему укладки).

THE MINIATURES ARE NOT IN PROPORTION.
I MINIMALI NON SONO IN PROPORZIONE.
Les illustrations à échelle réduite ne sont pas proportionnelles.
Die Abbildungen sind nicht verhältnismäßig.
Los miniaturas no están en proporción. n.
Изображения не соблюдают пропорций.

MARVEL SHINE Porcelain Tiles / Gres Porcellanato

DECOR RANGE / GAMMA DECORI

MARBLE LOOK

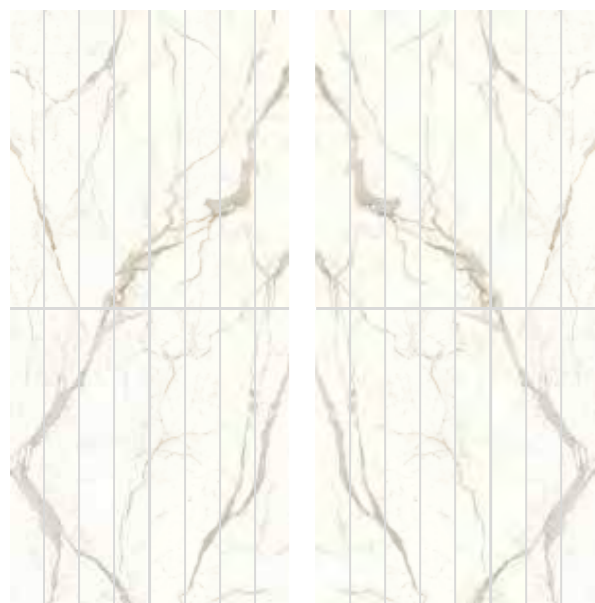

A421 Marvel Calacatta Prestigio
Scenic Bookm A Lp
120x278 - 47¹/₄"x109¹/₂"

A43L Marvel Calacatta Prestigio
Scenic Bookm B Lp
120x278 - 47¹/₄"x109¹/₂"

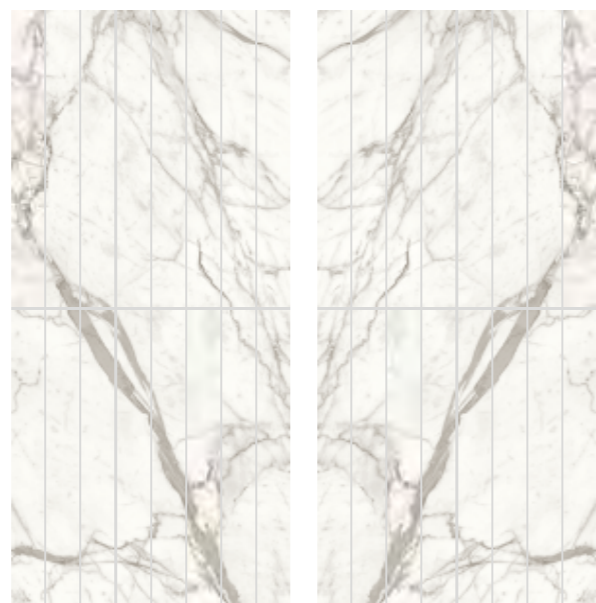

A430 Marvel Statuario Supremo
Scenic Bookm A Lp
120x278 - 47¹/₄"x109¹/₂"

A43M Marvel Statuario Supremo
Scenic Bookm B Lp
120x278 - 47¹/₄"x109¹/₂"

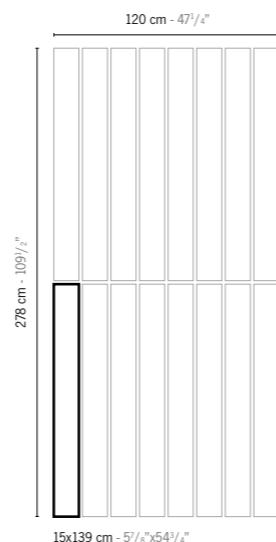

120x278 cm slabs cut into modules that recombine the open vein. This makes it possible to lay them even on curved surfaces. Each slab is cut into 16 numbered modules measuring 15x139 cm. To recreate the open vein, follow the sequence of pieces indicated in the laying patterns inside the packaging. Each slab is placed in 4 boxes, each of which contains 4 modules, for a total of 16 modules, corresponding to a surface of 3.3 mq. / Lastre 120cmx278cm tagliate in moduli che ricompongono la macchia aperta. Consentono la posa anche su superfici curve. Ogni lastra viene tagliata in 16 moduli numerati, di dimensione 15cmx139cm: per ricreare la macchia aperta seguire la sequenza dei pezzi indicata negli schemi di posa all'interno dell'imballaggio. Ogni lastra viene collocata in 4 scatole, ciascuna delle quali contiene 4 moduli, per un totale di 16 moduli, corrispondenti ad una superficie di 3,3mq. / Dalles de 120 cm x 278 cm découpées en modules qui recomposent la tache ouverte. Elles permettent la pose même sur des surfaces courbes. Chaque dalle est découpée en 16 modules numérotés, mesurant 15 cm x 139 cm: pour recréer la tache ouverte, suivez la séquence de pièces indiquée dans les schémas de pose à l'intérieur de l'emballage. Chaque dalle est placée dans 4 boîtes contenant chacune 4 modules, pour un total de 16 modules, correspondant à une surface de 3,3 mètres carrés. / Platten 120 cm x 278 cm, zu Modulen geschnitten, die das gespiegelte Motiv bilden. Die Verlegung ist auch auf gewölbten Oberflächen möglich. Jede Platte wird in 16 nummerierte Module mit Abmessungen 15 cm x 139 cm geschnitten: Um die Spiegeloptik zu erzielen, die auf den der Verpackung beiliegenden Verlegplänen angegebene Reihenfolge beachten. Jede Platte wird in 4 Schachteln mit je 4 Modulen verpackt. Die insgesamt 16 Module entsprechen einer Oberfläche von 3,3 qm. / Placas 120cmx278cm cortadas en módulos que recomponen la mancha abierta. También permiten la colocación en superficies curvas. Cada losa se corta en 16 módulos numerados que miden 15cmx139cm: para recrear la mancha abierta, se sigue la secuencia de las piezas indicadas en los esquemas de colocación dentro del embalaje. Cada losa se coloca en 4 cajas, cada una de estas contiene 4 módulos por un total de 16 módulos, lo que corresponde a un área de 3,3 metros cuadrados. / Плиты 120 см x 278 см разрезаны на модули, которые впоследствии складываются в симметричный зеркальный рисунок. Также возможна укладка на изогнутые поверхности. Каждая плита разрезается на 16 пронумерованных модулей размером 15 см x 139 см: чтобы заново сложить исходный симметричный рисунок, необходимо соблюдать последовательность, указанную на схемах укладки внутри упаковки. Каждая плита помещается в 4 коробки по 4 модуля; всего – 16 модулей, соответствующих площади 3,3 кв.м.

THE DECORATION CAN ONLY BE LAID ON THE WALL | IL DECORO SI PUÒ POSARE SOLO A RIVESTIMENTO
Décor uniquement mural | Das Dekor kann nur an der Wand verlegt werden | La decoración se puede colocar únicamente en paredes | Dekor может быть уложен только на стену.

MARBLE LOOK



A423 Marvel Calacatta Delicato
Mosaico Lapp.
30x30 - 11³/₄"x11³/₄"



A424 Marvel Calacatta Prestigio
Mosaico Lapp.
30x30 - 11³/₄"x11³/₄"



A425 Marvel Statuario Supremo
Mosaico Lapp.
30x30 - 11³/₄"x11³/₄"



A426 Marvel Calacatta Imperiale
Mosaico Lapp.
30x30 - 11³/₄"x11³/₄"

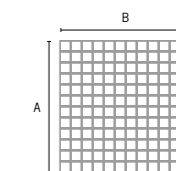

A 29,6 cm - 11⁵/₈"
B 29,6 cm - 11⁵/₈"



A413 Marvel Calacatta Delicato
Mosaico Matt
30x30 - 11³/₄"x11³/₄"



A414 Marvel Calacatta Prestigio
Mosaico Matt
30x30 - 11³/₄"x11³/₄"



A415 Marvel Statuario Supremo
Mosaico Matt
30x30 - 11³/₄"x11³/₄"



A416 Marvel Calacatta Imperiale
Mosaico Matt
30x30 - 11³/₄"x11³/₄"

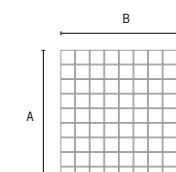

A 29,6 cm - 11⁵/₈"
B 29,6 cm - 11⁵/₈"



A42K Marvel Calacatta Delicato
Mos. Esagono Lapp.
30,5x35,2 - 12"x13³/₈"



A42W Marvel Calacatta Prestigio
Mos. Esagono Lapp.
30,5x35,2 - 12"x13³/₈"



A42X Marvel Statuario Supremo
Mos. Esagono Lapp.
30,5x35,2 - 12"x13³/₈"



A42Y Marvel Calacatta Imperiale
Mos. Esagono Lapp.
30,5x35,2 - 12"x13³/₈"

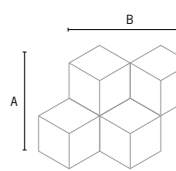

A 30,5 cm - 12"
B 35,2 cm - 13³/₈"



A417 Marvel Calacatta Delicato
Mos. Esagono Matt
30,5x35,2 - 12"x13³/₈"



A418 Marvel Calacatta Prestigio
Mos. Esagono Matt
30,5x35,2 - 12"x13³/₈"



A419 Marvel Statuario Supremo
Mos. Esagono Matt
30,5x35,2 - 12"x13³/₈"



A42J Marvel Calacatta Imperiale
Mos. Esagono Matt
30,5x35,2 - 12"x13³/₈"

MARVEL SHINE Porcelain Tiles / Gres Porcellanato

DECOR RANGE / GAMMA DECORI

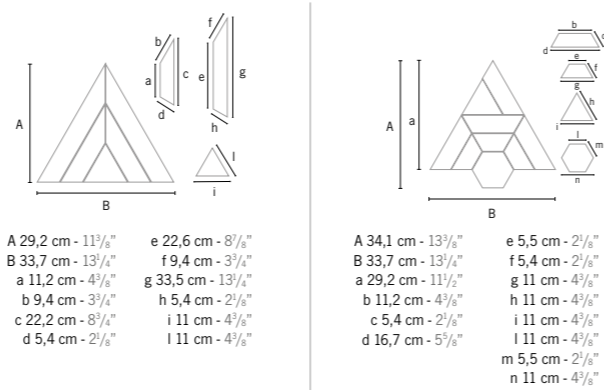
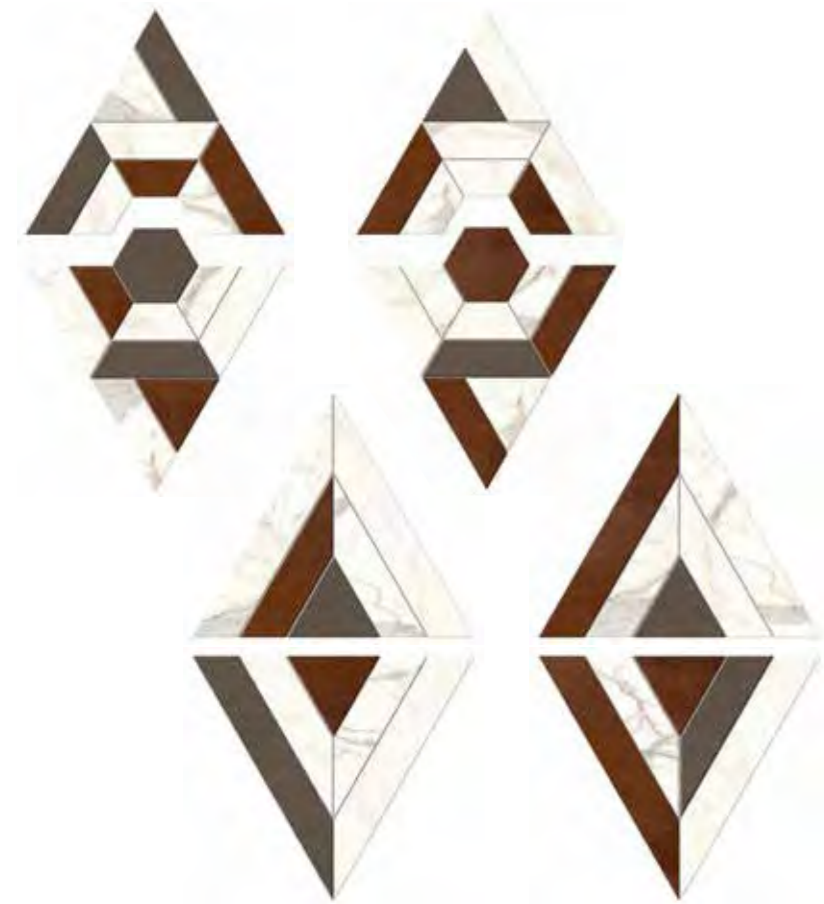

A42Z Marvel Mosaico Match Lapp 29,2x33,7 - 11 1/2"x13 3/4" ■
Calacatta Delicato + Calacatta Prestigio + Blaze Corten + Boost Pro Tobacco

TRIM TILES / PEZZI SPECIALI

p. 568



	Battiscopa		Battiscopa		Battiscopa		Gradino		Gradino		Gradino		Scalino		Scalino		Scalino		Scalino Ang.		Scalino Ang.		Corner		Corner A.E.		Battiscopa Sag. Scala							
	Lapp.	Silk	Matt	Lapp.	Silk	Matt	Lapp.	Silk	Lapp.	Silk	Lapp.	Silk	Lapp.	Silk	Lapp.	Silk	Lapp.	Silk	Lapp.	Silk	Lapp.	Silk	Lapp.	Silk	Lapp.	Silk	SX	DX	SX	DX	SX	DX		
Calacatta Delicato	A43T	A43P	A535	A43H	A539	A55F	A435	A54W	A443	A44Z	A3CV	A441	A543	A45K	A45G	A45C	A547	A55B	A450	-	A45U	A54K	A54G	A431	A43X	A54S	A540							
Calacatta Prestigio	A43U	A43Q	A536	A43I	A540	A55G	A436	A54X	A444	A440	A540	A44J	A544	A45L	A45H	A45D	A548	A55C	A45P	A45S	A45X	A54L	A54H	A432	A43Y	A54T	A54P							
Statuario Supremo	A43V	A43R	A537	A43J	A54E	A55H	A437	A54Y	A445	A441	A541	A44K	A545	A45M	A45I	A45E	A549	A55D	A45Q	A45T	A45W	A54M	A54I	A433	A43Z	A54U	A54Q							
Calacatta Imperiale	A43W	A43S	A538	A43K	A54F	A55I	A438	A54Z	A446	A442	A542	A44L	A546	A45N	A45J	A45F	A55A	A55E	A45R	-	A45V	A54N	A54J	A434	A430	A54V	A54R							

* THESE PARTS ARE SUPPLIED TO ORDER | PEZZI SONO DISPONIBILI SU ORDINAZIONE | Les pièces sont disponibles sur commande | Die Teile sind auf Bestellung lieferbar | Las piezas se hacen por encargo | Изготавливаются на заказ

■ A random laying pattern is recommended. Each box contains 8 elements comprising the composition shown in the figure. / Si consiglia uno schema di posa casuale. Ogni scatola contiene la composizione degli 8 elementi rappresentata in figura. / Un schéma de pose casuelle est conseillé. Chaque boîte contient la composition des 8 éléments indiqués dans l'image. / Es empfiehlt sich die Verlegung nach dem Zufallsprinzip. Jede Schachtel enthält die abgebildete Komposition aus den 8 Elementen. / Se recomienda un esquema aleatorio de colocación. Cada caja contiene la composición de los 8 elementos que se muestran en la figura. / Рекомендуется произвольная схема укладки. Каждая коробка содержит композицию из 8 элементов, показанную на рисунке.



MARBLE LOOK

335

MARBLE LOOK



MARVEL

SHINE

WALL TILES

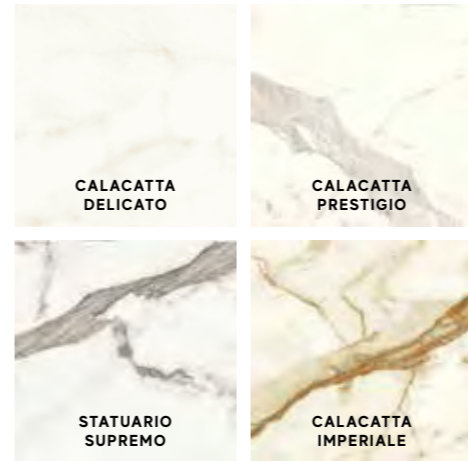

DECORATIVE RANGE / GAMMA DECORATIVA



Wall Tiles / Rivestimento

WHITEBODY WALL TILES - RECTIFIED MONOCALIBER
RIVESTIMENTI IN PASTA BIANCA - RETTIFICATO MONOCALIBRO

Sizes	Thickness	Surface finish
50x120 cm - 19 ⁵ / ₈ "x47 ¹ / ₄ "	± 8,5 mm	Silk
40x80 cm - 15 ³ / ₄ "x31 ¹ / ₂ "	± 8,5 mm	Shiny



MARVEL SHINE Wall Tiles / Rivestimento

SILK SURFACE / SUPERFICIE SILK



SHINY SURFACE / SUPERFICIE LUCIDA

MARBLE LOOK

WALL TILES



A4TT Marvel Calacatta Delicato 50x120 Silk
50x120 cm - 19⁵/₈"x47¹/₄"



A4TU Marvel Calacatta Prestigio 50x120 Silk
50x120 cm - 19⁵/₈"x47¹/₄"



A4TV Marvel Statuario Supremo 50x120 Silk
50x120 cm - 19⁵/₈"x47¹/₄"



A4TW Marvel Calacatta Imperiale 50x120 Silk
50x120 cm - 19⁵/₈"x47¹/₄"



**V2
SLIGHT
VARIATION**
Calacatta Delicato,
Calacatta Prestigio,
Statuario Supremo



**V3
MODERATE
VARIATION**
Calacatta Imperiale



A3ZS Marvel Calacatta Delicato 40x80 Shiny
40x80 - 15³/₄"x31¹/₂"



A3ZT Marvel Calacatta Prestigio 40x80 Shiny
40x80 - 15³/₄"x31¹/₂"



A3ZU Marvel Statuario Supremo 40x80 Shiny
40x80 - 15³/₄"x31¹/₂"



A3ZV Marvel Calacatta Imperiale 40x80 Shiny
40x80 - 15³/₄"x31¹/₂"



**V2
SLIGHT
VARIATION**
Calacatta Delicato,
Calacatta Prestigio,
Statuario Supremo



**V3
MODERATE
VARIATION**
Calacatta Imperiale

SILK SURFACE | SUPERFICIE SILK | Surface Silk | Oberfläche Silk | Superficie Silk | Поверхность Silk
SHINY SURFACE | SUPERFICIE LUCIDA | Surface brillante | Glänzende oberfläche | Superficie brillante | Глянцев поверхность

MARBLE LOOK

WALL TILES

MARVEL SHINE Wall Tiles / Rivestimento

DECOR RANGE / GAMMA DECORI



MARBLE LOOK

WALL TILES



A4WK Marvel Calacatta Delicato
Mos. Twist Shiny
30,5x30,5 - 12"x12"



A4WL Marvel Calacatta Prestigio
Mos. Twist Shiny
30,5x30,5 - 12"x12"



A4WM Marvel Statuario Supremo
Mos. Twist Shiny
30,5x30,5 - 12"x12"



A4WN Marvel Calacatta Imperiale
Mos. Twist Shiny
30,5x30,5 - 12"x12"



A4WO Marvel Calacatta Delicato
Mos. Twist Silk
30,5x30,5 - 12"x12"



A4WP Marvel Calacatta Prestigio
Mos. Twist Silk
30,5x30,5 - 12"x12"



A4WQ Marvel Statuario Supremo
Mos. Twist Silk
30,5x30,5 - 12"x12"



A4WR Marvel Calacatta Imperiale
Mos. Twist Silk
30,5x30,5 - 12"x12"



A4WT Marvel Calacatta Delicato
Gold Hex Shiny
25,1x29 - 9 7/8"x11 3/8"



A4WU Marvel Calacatta Prestigio
Gold Hex Shiny
25,1x29 - 9 7/8"x11 3/8"



A4WV Marvel Statuario Supremo
Platino Hex Shiny
25,1x29 - 9 7/8"x11 3/8"



A4WW Marvel Calacatta Imperiale
Gold Hex Shiny
25,1x29 - 9 7/8"x11 3/8"

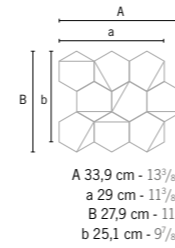
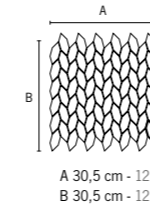

A4WS Marvel Calacatta Prestigio
Rose Hex Silk
25,1x29 - 9 7/8"x11 3/8"

TRIM TILES / PEZZI SPECIALI

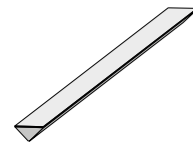

1,4x50 cm - 5/8"x19 5/8"
A41D Marvel Calacatta Delicato Corner 50 Silk *
A41E Marvel Calacatta Prestigio Corner 50 Silk *
A41F Marvel Statuario Supremo Corner 50 Silk *
A41G Marvel Calacatta Imperiale Corner 50 Silk *

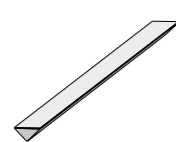

1,4x40 cm - 5/8"x15 3/4"
A41H Marvel Calacatta Delicato Corner 40 Shiny *
A41I Marvel Calacatta Prestigio Corner 40 Shiny *
A41J Marvel Statuario Supremo Corner 40 Shiny *
A41K Marvel Calacatta Imperiale Corner 40 Shiny *



1,4x1,4 cm - 5/8"x5/8"
A41L Marvel Calacatta Delicato Corner A.E. *
A41M Marvel Calacatta Prestigio Corner A.E. *
A41N Marvel Statuario Supremo Corner A.E. *
A41O Marvel Calacatta Imperiale Corner A.E. *

* THESE PARTS ARE SUPPLIED TO ORDER. I PEZZI SONO DISPONIBILI SU ORDINAZIONE
Les pièces sont disponibles sur commande | Die Teile sind auf Bestellung lieferbar | Las piezas se hacen por encargo | Изготавливаются на заказ

Decor with gold insert. / Decoro con inserto in oro. / Décor avec insert en or. / Dekor mit Einlage gold. / Decoración con aplicación de oro. / декор с золотой вставкой.



MARBLE LOOK

WALL TILES



MARVEL

STONE

PORCELAIN&WALL TILES

Porcelain Tiles / Gres Porcellanato

COLOURED BODY PORCELAIN TILES - RECTIFIED MONOCALIBER
GRES PORCELLANATO COLORATO IN MASSA - RETTIFICATO MONOCALIBRO

LARGE SIZES p. 500

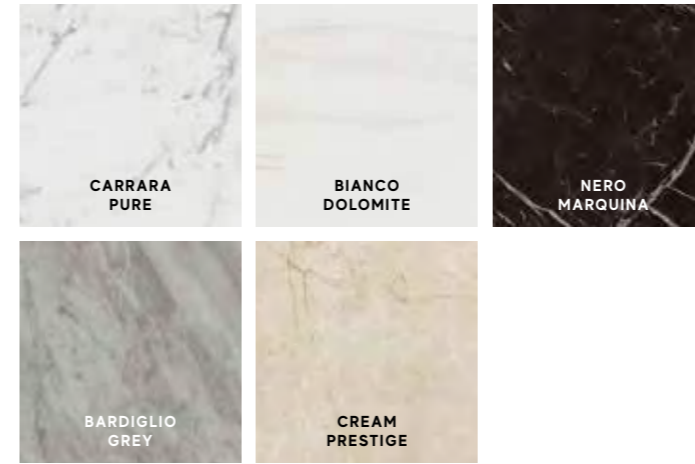

Sizes	Thickness	Surface finish
162x324 cm - 63 ³ / ₄ "x127 ¹ / ₂ " * NON RECTIFIED - NON RETTIFICATO	± 6-12-20 mm	Polished Silk Satin
160x320 cm - 63"x126"	± 6 mm	Polished
160x160 cm - 63"x63"	± 6 mm	Polished
120x278 cm - 47 ¹ / ₄ "x109 ¹ / ₂ "	± 6 mm	Polished Matte R9 A
120x240 cm - 47 ¹ / ₄ "x94 ¹ / ₂ "	± 9 mm	Polished
120x120 cm - 47 ¹ / ₄ "x47 ¹ / ₄ "	± 9 mm	Polished Matte R9 A
60x120 cm - 23 ⁵ / ₈ "x47 ¹ / ₄ "	± 9 mm	Polished Matte R9 A
75x150 cm - 29 ¹ / ₂ "x59"	± 9 mm	Polished
75x75 cm - 29 ¹ / ₂ "x29 ¹ / ₂ "	± 9 mm	Polished
45x90 cm - 17 ³ / ₄ "x35 ³ / ₈ "	± 9 mm	Polished Matte R9 A
60x60 cm - 23 ⁵ / ₈ "x23 ⁵ / ₈ "	± 9 mm	Polished Matte R9 A
30x60 cm - 11 ³ / ₄ "x23 ⁵ / ₈ "	± 9 mm	Polished Matte R9 A

MARVEL STONE COLLECTION
STONE LOOK p. 418

Wall Tiles / Rivestimento

WHITEBODY WALL TILES - RECTIFIED MONOCALIBER
RIVESTIMENTI IN PASTA BIANCA - RETTIFICATO MONOCALIBRO

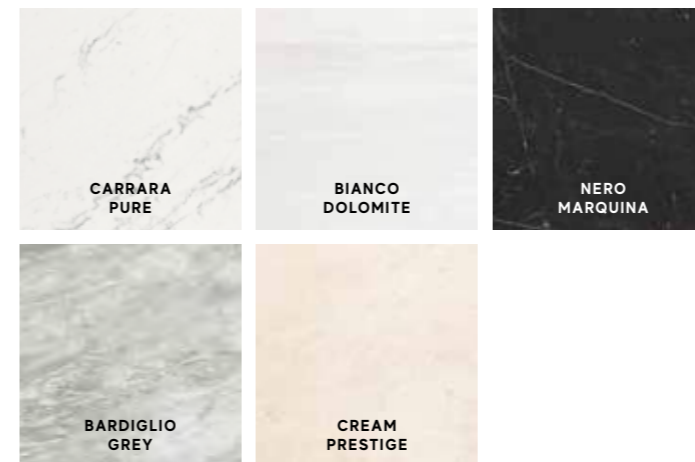

Sizes	Thickness	Surface finish
50x120 cm - 19 ⁵ / ₈ "x47 ¹ / ₄ "	± 8,5 mm	Shiny
40x80 cm - 15 ³ / ₄ "x31 ¹ / ₂ "	± 8,5 mm	Shiny

MARVEL STONE Porcelain Tiles / Gres Porcellanato

POLISHED SURFACE / SUPERFICIE LAPPATA

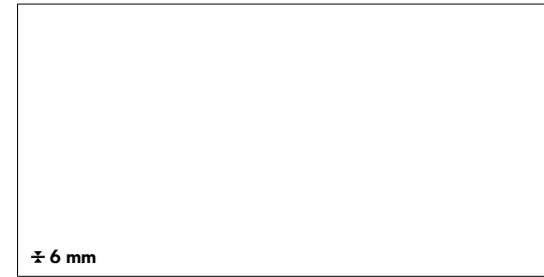

160x320 cm 63"x126"
A05X Marvel Bianco Dolomite 160x320RT Lappato

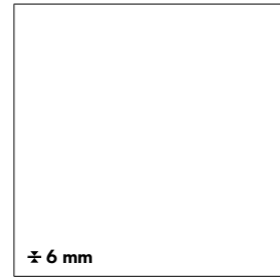

160x160 cm 63"x63"
A053 Marvel Bianco Dolomite 160x160RT Lappato



p. 500
POLISHED / LAPPATO
162x324 cm 63³/₄"x127¹/₂"
> **NON RECTIFIED / NON RETTIFICATO**
AAVG Bianco Dolomite A Polished ± 12 mm ST *
ANWA Nero Marquina Polished ± 12 mm ST *



120x278 cm 47¹/₄"x109¹/₂"
A0BP Marvel Bianco Dolomite 120x278 Lappato
A2RW Marvel Carrara Pure 120x278 Lappato



120x240 cm 47¹/₄"x94¹/₂"
AZTV Marvel Bianco Dolomite 120x240 Lappato
AZTW Marvel Carrara Pure 120x240 Lappato

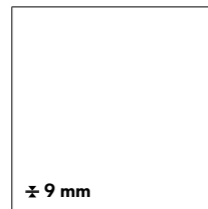

120x120 cm 47¹/₄"x47¹/₄"
AZTT Marvel Bianco Dolomite 120x120 Lappato
AZTU Marvel Carrara Pure 120x120 Lappato



60x120 cm 23⁵/₈"x47¹/₄"
A21K Marvel Bianco Dolomite 60x120 Lappato
AKSØ Marvel Carrara Pure 60x120 Lappato

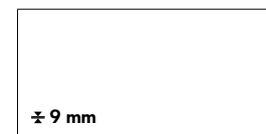

75x150 cm 29¹/₂"x59"
AZNB Marvel Bianco Dolomite 75x150 Lappato
AZNC Marvel Cream Prestige 75x150 Lappato
AZND Marvel Bardiglio Grey 75x150 Lappato
AZNE Marvel Carrara Pure 75x150 Lappato
AZNF Marvel Nero Marquina 75x150 Lappato

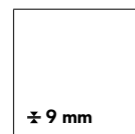

75x75 cm 29¹/₂"x29¹/₂"
AZNH Marvel Bianco Dolomite 75x75 Lappato
AZNI Marvel Cream Prestige 75x75 Lappato
AZNJ Marvel Bardiglio Grey 75x75 Lappato
AZNK Marvel Carrara Pure 75x75 Lappato
AZNL Marvel Nero Marquina 75x75 Lappato

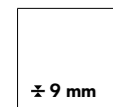

60x60 cm 23⁵/₈"x23⁵/₈"
AZRI Marvel Bianco Dolomite 60x60 Lappato
AZRJ Marvel Cream Prestige 60x60 Lappato
AZRK Marvel Bardiglio Grey 60x60 Lappato
AZRL Marvel Carrara Pure 60x60 Lappato
AZRM Marvel Nero Marquina 60x60 Lappato

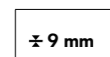

30x60 cm 11³/₄"x23⁵/₈"
D039 Marvel Bianco Dolomite 30x60 Lappato
D040 Marvel Cream Prestige 30x60 Lappato
D041 Marvel Bardiglio Grey 30x60 Lappato
D044 Marvel Carrara Pure 30x60 Lappato
D045 Marvel Nero Marquina 30x60 Lappato



45x90 cm 17³/₄"x35⁵/₈"
AZRU Marvel Bianco Dolomite 45x90 Lappato
AZRV Marvel Cream Prestige 45x90 Lappato
AZRW Marvel Bardiglio Grey 45x90 Lappato
AZRX Marvel Carrara Pure 45x90 Lappato
AZRY Marvel Nero Marquina 45x90 Lappato

The glossy polished finish is suitable for residential or low-traffic commercial floors, where no anti-slip performance is required, and for walls. The polished glossy surface finish, surprisingly brilliant and bright, features slight irregularities typical of natural marble. The extraordinary brilliance and the easy cleaning of the surface are the result of in-depth research aimed at guaranteeing its durability over time. - If the product is in direct contact with the outdoors, provide devices for absorbing moisture and dirt to prevent scratches. / La finitura lappata lucida è indicata per pavimenti residenziali o commerciali poco sollecitati, laddove non siano richieste prestazioni antiscivolo, e per rivestimenti. La finitura lappata lucida offre una superficie sorprendentemente brillante e specchiante, con lievi irregolarità tipiche dei marmi naturali. La straordinaria lucentezza e l'elevata pulibilità della superficie sono frutto di studi approfonditi e accurate ricerche tecniche volte a garantirne la persistenza nel tempo. - Se il prodotto è a diretto contatto con l'esterno, prevedere dei dispositivi di assorbimento dell'umidità e della sporcizia per prevenire la formazione di graffi.

POLISHED SURFACE | SUPERFICIE LAPPATA | Surface adouci | Gelläppt oberfläche | Superficie brulhada | Полиполированный поверхность

* **WITH FIBERGLASS MESH** | VERSIONE STUOIATA | Version à nattes | Ausführung mit Glasfasermatte | Versión con malla | C упрочнением из стекловолоконка
NON RECTIFIED | NON RETTIFICATO | Non rectifié | Nicht rektifiziert | No rectificada | Неретифицированные



V2
SLIGHT
VARIATION

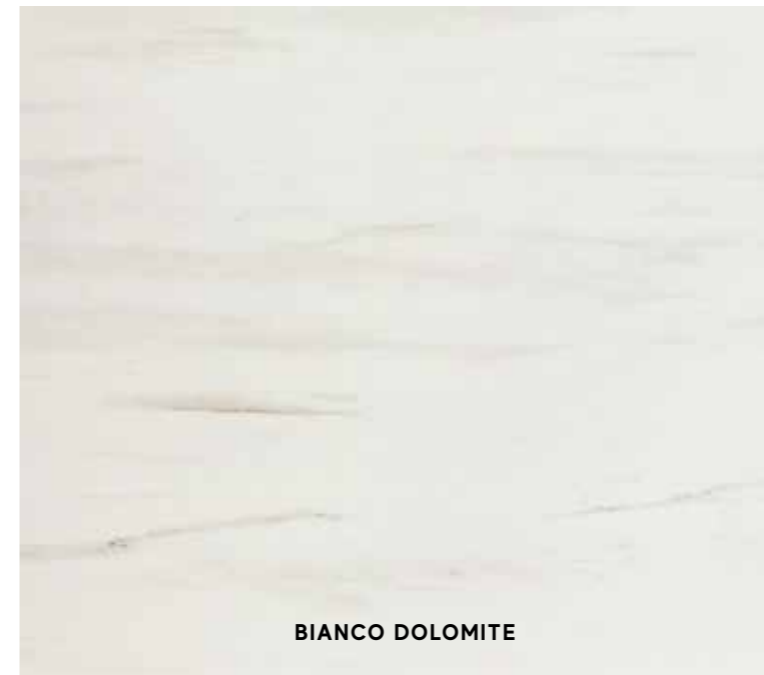

BIANCO DOLOMITE



CARRARA PURE



CREAM PRESTIGE



BARDIGLIO GREY



NERO MARQUINA

MARVEL STONE Porcelain Tiles / Gres Porcellanato

MATTE SURFACE / SUPERFICIE MATT



atlasPLAN p. 500



SILK / SATIN
162x324 cm 63³/₄"x127¹/₂"
 > **NON RECTIFIED** / NON RETTIFICATO
 AAV6 Cream Prestige Silk ± 12 mm ST *
 A07Y Nero Marquina Silk ± 6 mm ST *
 ANVK Nero Marquina Silk ± 12 mm ST *
 A3M5 Nero Marquina Satin ± 12 mm ST *
 A2XT Nero Marquina Silk ± 20 mm



120x278 cm 47¹/₄"x109¹/₂"
 A2RS Marvel Bianco Dolomite 120x278 Matt
 A2RV Marvel Carrara Pure 120x278 Matt

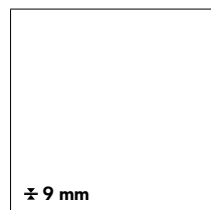

120x120 cm 47¹/₄"x47¹/₄"
 A204 Marvel Bianco Dolomite 120x120 Matt
 A207 Marvel Carrara Pure 120x120



60x120 cm 23³/₈"x47¹/₄"
 A21C Marvel Bianco Dolomite 60x120
 A21E Marvel Carrara Pure 60x120

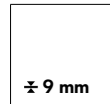

60x60 cm 23⁵/₈"x23⁵/₈"
 AZQS Marvel Bianco Dolomite 60x60
 AZQT Marvel Cream Prestige 60x60
 AZQU Marvel Bardiglio Grey 60x60
 AZQV Marvel Carrara Pure 60x60
 AZQW Marvel Nero Marquina 60x60



30x60 cm 11³/₄"x23⁵/₈"
 D110 Marvel Bianco Dolomite 30x60
 D111 Marvel Cream Prestige 30x60
 D112 Marvel Bardiglio Grey 30x60
 D113 Marvel Carrara Pure 30x60
 D114 Marvel Nero Marquina 30x60



45x90 cm 17³/₄"x35⁵/₈"
 AZRZ Marvel Bianco Dolomite 45x90
 AZR0 Marvel Cream Prestige 45x90
 AZR1 Marvel Bardiglio Grey 45x90
 AZR3 Marvel Carrara Pure 45x90
 AZR4 Marvel Nero Marquina 45x90



TRIM TILES / PEZZI SPECIALI
 p. 568

UPEC p. 595

	Battiscopa 7,2x60 - 2 ⁷ / ₈ "x23 ⁵ / ₈ "		Battiscopa Digitale 4,6x60 - 1 ³ / ₄ "x23 ⁵ / ₈ "		Gradino * 30x60 11 ³ / ₄ "x23 ⁵ / ₈ "	Scalino * 33x60 13"x23 ⁵ / ₈ "	Scalino Angolare 33x33 - 13"x13"		Battiscopa Sag. Scala 7,2x30 - 2 ⁷ / ₈ "x11 ³ / ₄ "	
	Matt	Lappato	Matt	Lappato			DX *	SX *	DX *	SX *
Bianco Dolomite	ATDT	ATDO	ATDJ	ATDE	ATDY	ATD3	ATEE	ATD8	ATEO	ATEJ
Cream Prestige	ATDU	ATDP	ATDK	ATDF	ATDZ	ATD4	ATEF	ATD9	ATEP	ATEK
Bardiglio Grey	ATDV	ATDQ	ATDL	ATDG	ATD0	ATD5	ATEG	ATEA	ATEQ	ATEL
Carrara Pure	ATDW	ATDR	ATDM	ATDH	ATD1	ATD6	ATEH	ATEC	ATER	ATEM
Nero Marquina	ATDX	ATDS	ATDN	ATDI	ATD2	ATD7	ATEI	ATED	ATES	ATEN

* THESE PARTS ARE SUPPLIED TO ORDER | I PEZZI SONO DISPONIBILI SU ORDINAZIONE
 Les pièces sont disponibles sur commande | Die Teile sind auf Bestellung lieferbar | Las piezas se hacen por encargo | Изготавливаются на заказ

* WITH FIBERGLASS MESH | VERSIONE STUOIATA | Version à nattes | Ausführung mit Glasfasermatte | Versión con malla | С упрочнением из стекловолоконна
NON RECTIFIED | NON RETTIFICATO | Non rectifié | Nicht rektifiziert | No rectificada | Неретифицированные

MATTE SURFACE | SUPERFICIE MATT | Surface Mat | Matt oberfläche | Superficie Mate | Матовая поверхность



V2
SLIGHT
VARIATION

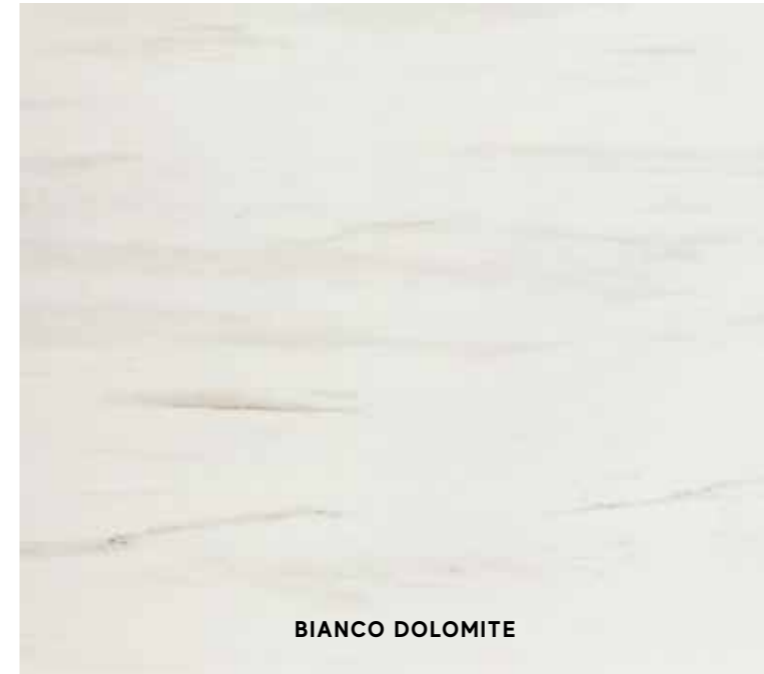

BIANCO DOLOMITE



CARRARA PURE



CREAM PRESTIGE



BARDIGLIO GREY



NERO MARQUINA

MARVEL STONE Porcelain Tiles / Gres Porcellanato

DECOR RANGE / GAMMA DECORI

MARBLE LOOK



AS2J Marvel Carrara Pure Mosaico Esagono Lappato 30x35 - 11³/₄"x13³/₄"

AS2G Marvel Bianco Dolomite Mosaico Esagono Lappato 30x35 - 11³/₄"x13³/₄"

AS2H Marvel Cream Prestige Mosaico Esagono Lappato 30x35 - 11³/₄"x13³/₄"

AS2I Marvel Bardiglio Grey Mosaico Esagono Lappato 30x35 - 11³/₄"x13³/₄"

AS2K Marvel Nero Marquina Mosaico Esagono Lappato 30x35 - 11³/₄"x13³/₄"



AS3T Marvel Carrara Pure Mosaico Lappato 30x30 - 11³/₄"x11³/₄"

AS2T Marvel Bianco Dolomite Mosaico Lappato 30x30 - 11³/₄"x11³/₄"

AS3Q Marvel Cream Prestige Mosaico Lappato 30x30 - 11³/₄"x11³/₄"

AS3S Marvel Bardiglio Grey Mosaico Lappato 30x30 - 11³/₄"x11³/₄"

AS3U Marvel Nero Marquina Mosaico Lappato 30x30 - 11³/₄"x11³/₄"

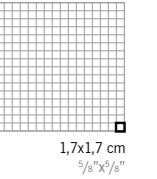

AS1V Marvel Carrara Pure Chevron Lappato 22,5x22,9 - 8³/₄"x9"

AS1Q Marvel Bianco Dolomite Chevron Lappato 22,5x22,9 - 8³/₄"x9"

AS1R Marvel Cream Prestige Chevron Lappato 22,5x22,9 - 8³/₄"x9"

AS1U Marvel Bardiglio Grey Chevron Lappato 22,5x22,9 - 8³/₄"x9"

AS1W Marvel Nero Marquina Chevron Lappato 22,5x22,9 - 8³/₄"x9"

AS2F Marvel Chevron Cold Lappato Carrara Pure + Nero Marquina 22,5x22,9 - 8³/₄"x9"

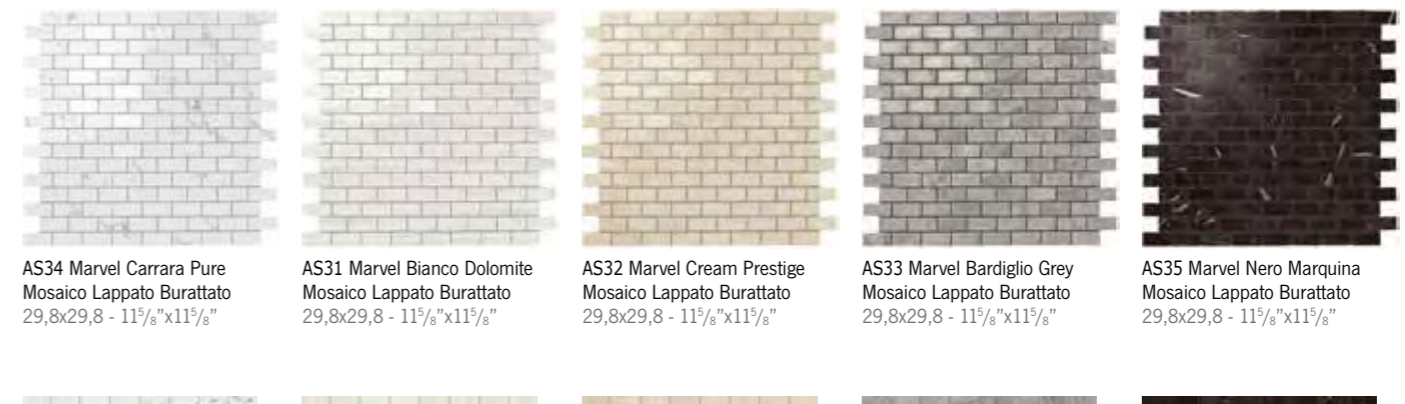

AS34 Marvel Carrara Pure Mosaico Lappato Burattato 29,8x29,8 - 11⁵/₈"x11⁵/₈"

AS31 Marvel Bianco Dolomite Mosaico Lappato Burattato 29,8x29,8 - 11⁵/₈"x11⁵/₈"

AS32 Marvel Cream Prestige Mosaico Lappato Burattato 29,8x29,8 - 11⁵/₈"x11⁵/₈"

AS33 Marvel Bardiglio Grey Mosaico Lappato Burattato 29,8x29,8 - 11⁵/₈"x11⁵/₈"

AS35 Marvel Nero Marquina Mosaico Lappato Burattato 29,8x29,8 - 11⁵/₈"x11⁵/₈"

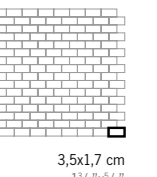

AS4A Marvel Carrara Pure Mosaico Esagono 3D 28,2x35,3 - 11"x14"

AS36 Marvel Bianco Dolomite Mosaico Esagono 3D 28,2x35,3 - 11"x14"

AS38 Marvel Cream Prestige Mosaico Esagono 3D 28,2x35,3 - 11"x14"

AS39 Marvel Bardiglio Grey Mosaico Esagono 3D 28,2x35,3 - 11"x14"

AS4B Marvel Nero Marquina Mosaico Esagono 3D 28,2x35,3 - 11"x14"

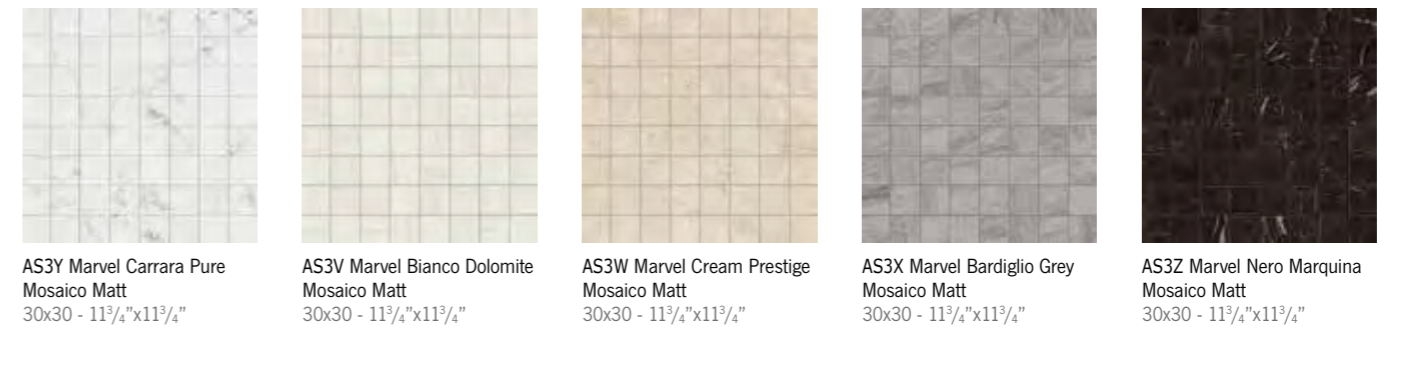

AS3Y Marvel Carrara Pure Mosaico Matt 30x30 - 11³/₄"x11³/₄"

AS3V Marvel Bianco Dolomite Mosaico Matt 30x30 - 11³/₄"x11³/₄"

AS3W Marvel Cream Prestige Mosaico Matt 30x30 - 11³/₄"x11³/₄"

AS3X Marvel Bardiglio Grey Mosaico Matt 30x30 - 11³/₄"x11³/₄"

AS3Z Marvel Nero Marquina Mosaico Matt 30x30 - 11³/₄"x11³/₄"

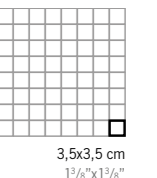

AS2L Marvel Mosaico Esagono Geo Cold Lappato 25,4x35,2 - 10"x13³/₄" Carrara Pure + Bardiglio Grey + Nero Marquina

AS2M Marvel Mosaico Esagono Geo Warm Lappato 25,4x35,2 - 10"x13³/₄" Bianco Dolomite + Cream Prestige + Nero Marquina

AS2O Marvel Basketweave Cold Lappato 30x30 - 11³/₄"x11³/₄" Carrara Pure + Nero Marquina

AS2P Marvel Basketweave Warm Lappato 30x30 - 11³/₄"x11³/₄" Cream Prestige + Nero Marquina

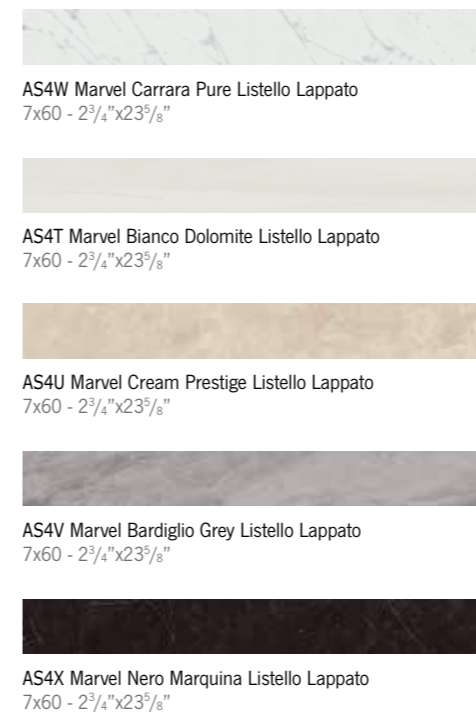

AS4W Marvel Carrara Pure Listello Lappato 7x60 - 2³/₄"x23⁵/₈"

AS4T Marvel Bianco Dolomite Listello Lappato 7x60 - 2³/₄"x23⁵/₈"

AS4U Marvel Cream Prestige Listello Lappato 7x60 - 2³/₄"x23⁵/₈"

AS4V Marvel Bardiglio Grey Listello Lappato 7x60 - 2³/₄"x23⁵/₈"

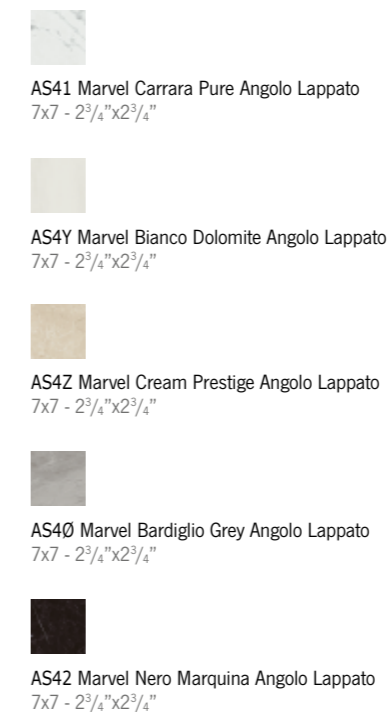

AS41 Marvel Carrara Pure Angolo Lappato 7x7 - 2³/₄"x2³/₄"

AS4Y Marvel Bianco Dolomite Angolo Lappato 7x7 - 2³/₄"x2³/₄"

AS4Z Marvel Cream Prestige Angolo Lappato 7x7 - 2³/₄"x2³/₄"

AS4Ø Marvel Bardiglio Grey Angolo Lappato 7x7 - 2³/₄"x2³/₄"



AMMS Marvel Half Hex Cold Lappato 33x48,3 - 13"x19" Carrara Pure + Nero Marquina

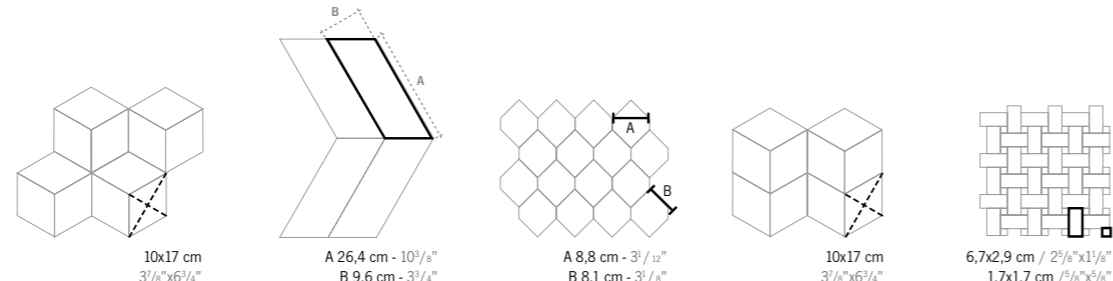
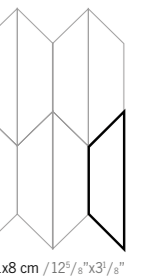

10x17 cm 3 1/8"x6 1/4"

A 26,4 cm - 10 3/8" B 9,6 cm - 3 7/8"

A 8,8 cm - 3 1/2" B 8,1 cm - 3 1/8"

10x17 cm 3 1/8"x6 1/4"

6,7x2,9 cm / 2 5/8"x1 1/8" 1,7x1,7 cm 5/8"x5/8"

MARBLE LOOK



MARVEL

STONE

WALL TILES

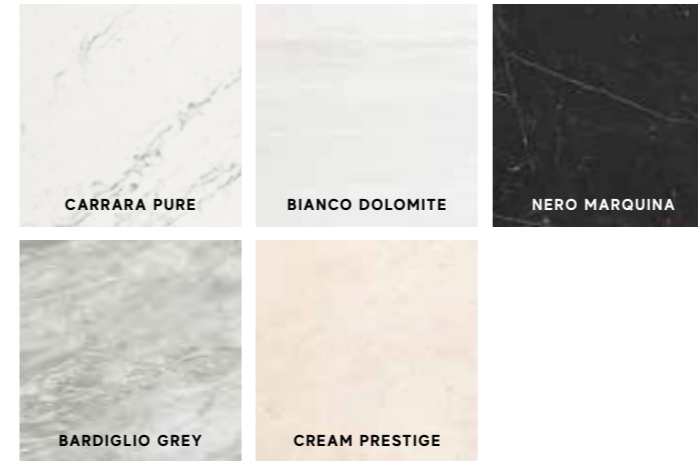

Wall Tiles / Rivestimento | Marble Look

WHITEBODY WALL TILES - RECTIFIED MONOCALIBER
RIVESTIMENTI IN PASTA BIANCA - RETTIFICATO MONOCALIBRO

Sizes	Thickness	Surface finish
50x120 cm - 19 ⁵ / ₈ "x47 ¹ / ₄ "	± 8,5 mm	Shiny
40x80 cm - 15 ³ / ₄ "x31 ¹ / ₂ "	± 8,5 mm	Shiny

DECORATIVE RANGE / GAMMA DECORATIVA

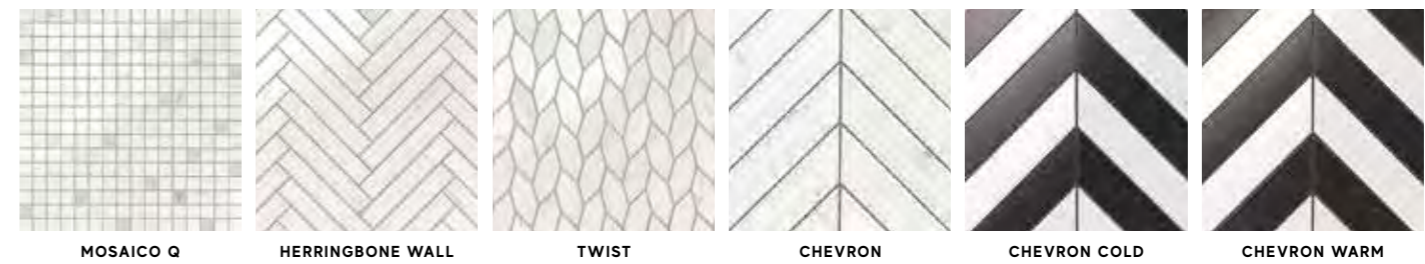

MARVEL STONE Wall Tiles / Rivestimento | Marble Look

SHINY SURFACE / SUPERFICIE LUCIDA



MARBLE LOOK

WALL TILES



A4S3 Marvel Carrara Pure 120
50x120 - 19³/₈"x47¹/₄"



A4S4 Marvel Bianco Dolomite 120
50x120 - 19³/₈"x47¹/₄"



A4S5 Marvel Cream Prestige 120
50x120 - 19³/₈"x47¹/₄"



A4S6 Marvel Bardiglio Grey 120
50x120 - 19³/₈"x47¹/₄"

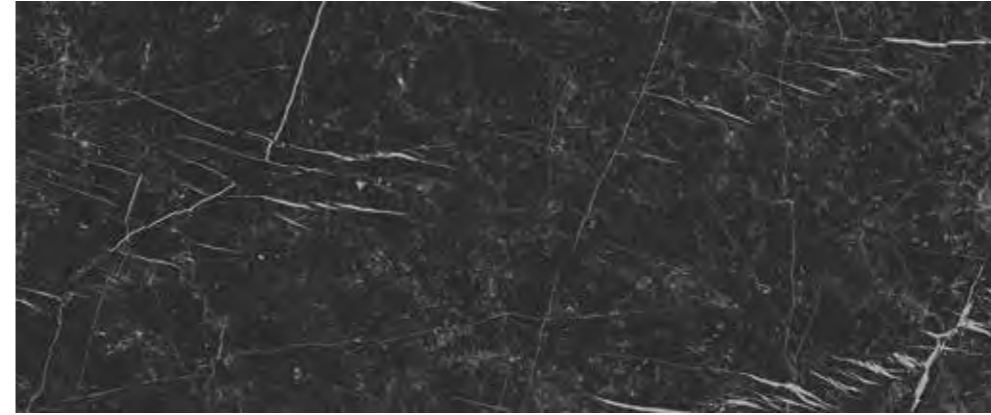

A4S7 Marvel Nero Marquina 120
50x120 - 19³/₈"x47¹/₄"



9MSF Marvel Carrara Pure 40x80
40x80 - 15³/₄"x31¹/₂"



9MSB Marvel Bianco Dolomite 40x80
40x80 - 15³/₄"x31¹/₂"



9MSI Marvel Cream Prestige 40x80
40x80 cm - 15³/₄"x31¹/₂"



9MSD Marvel Bardiglio Grey 40x80
40x80 - 15³/₄"x31¹/₂"



9MSM Marvel Nero Marquina 40x80
40x80 cm - 15³/₄"x31¹/₂"



V2
SLIGHT
VARIATION

SHINY SURFACE | SUPERFICIE LUCIDA | Surface brillante | Glänzende oberfläche | Superficie brillante | Глянec поверхность

MARBLE LOOK

WALL TILES



V2
SLIGHT
VARIATION

353

MARVEL STONE Wall Tiles / Rivestimento | Marble Look

DECOR RANGE / GAMMA DECORI

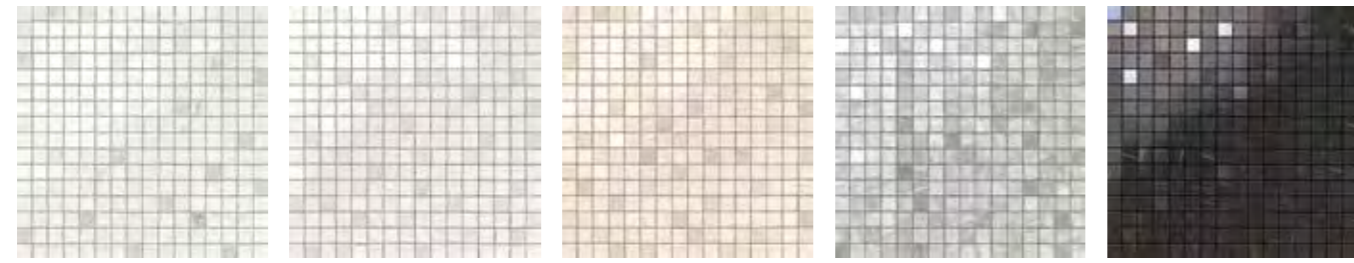

9MQC Marvel Carrara Pure Mosaic Q 30,5x30,5 - 12"x12"
 9MQB Marvel Bianco Dolomite Mosaic Q 30,5x30,5 - 12"x12"
 9MQE Marvel Cream Prestige Mosaic Q 30,5x30,5 - 12"x12"
 9MQA Marvel Bardiglio Grey Mosaic Q 30,5x30,5 - 12"x12"
 9MQN Marvel Nero Marquina Mosaic Q 30,5x30,5 - 12"x12"

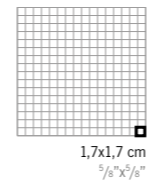

9SHC Marvel Carrara Pure Herringbone Wall 30,5x30 - 12"x11³/₄"
 9SHD Marvel Bianco Dolomite Herringbone Wall 30,5x30 - 12"x11³/₄"
 9SHE Marvel Cream Prestige Herringbone Wall 30,5x30 - 12"x11³/₄"
 9SHB Marvel Bardiglio Grey Herringbone Wall 30,5x30 - 12"x11³/₄"
 9SHN Marvel Nero Marquina Herringbone Wall 30,5x30 - 12"x11³/₄"

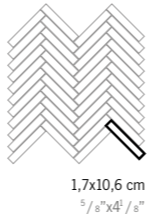

9STA Marvel Carrara Pure Twist 30,5x30,5 - 12"x12"
 9STD Marvel Bianco Dolomite Twist 30,5x30,5 - 12"x12"
 9STE Marvel Cream Prestige Twist 30,5x30,5 - 12"x12"
 9STB Marvel Bardiglio Grey Twist 30,5x30,5 - 12"x12"
 9STN Marvel Nero Marquina Twist 30,5x30,5 - 12"x12"

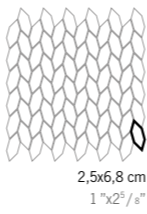

9SCA Marvel Carrara Pure Chevron Wall 30,5x25 - 12"x9⁷/₈"



9SCD Marvel Bianco Dolomite Chevron Wall 30,5x25 - 12"x9⁷/₈"



9SCN Marvel Nero Marquina Chevron Wall 30,5x25 - 12"x9⁷/₈"

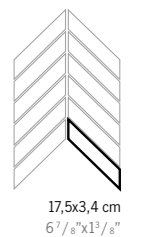

9SCL Marvel Chevron Cold Wall 30,5x25 - 12"x9⁷/₈" Carrara Pure + Nero Marquina



9SCW Marvel Chevron Warm Wall 30,5x25 - 12"x9⁷/₈" Bianco Dolomite + Nero Marquina



9SCM Marvel Chevron Mix Wall 30,5x25 - 12"x9⁷/₈" Carrara Pure + Bardiglio Grey + Nero Marquina

• **DECOR WITH GOLD INSERT.**
 DECORO CON INSERTO IN ORO.
 Décor avec insert en OR.
 Dekor mit Einlage GOLD.
 Decoración con aplicación de ORO.
 Декор с ЗОЛОТОЙ вставкой.



ASEK Marvel Greca Gold • 7,8x30,5 - 3¹/₈"x12"



ASEM Marvel Greca A.E. • 7,8x1,2 - 3¹/₈"x¹/₂"



LVGB Marvel Gold Black • 7,8x30,5 - 3¹/₈"x12"



AVGB Marvel Gold Black A.E. • 7,8x1,2 - 3¹/₈"x¹/₂"



LVGW Marvel Gold White • 7,8x30,5 - 3¹/₈"x12"



AVGW Marvel Gold White A.E. • 7,8x1,2 - 3¹/₈"x¹/₂"

TRIM TILES / PEZZI SPECIALI

	LSLH Marvel Carrara Pure London 5x30,5 - 2"x12"		ALSF Marvel Carrara Pure London A.E. 5x2,5 - 2"x1"		LSLO Marvel Bardiglio Grey London 5x30,5 - 2"x12"		ALSG Marvel Bardiglio Grey London A.E. 5x2,5 - 2"x1"
	LSSA Marvel Carrara Pure Spigolo 0,8x20 - 3 ¹ / ₈ "x7 ⁷ / ₈ "		AS1A Marvel Carrara Pure Spigolo A.E. 0,8x0,8 - 3 ¹ / ₈ "x ² / ₈ "		LSSB Marvel Bardiglio Grey Spigolo 0,8x20 - 3 ¹ / ₈ "x7 ⁷ / ₈ "		AS1G Marvel Bardiglio Grey Spigolo A.E. 0,8x0,8 - 3 ¹ / ₈ "x ² / ₈ "
	LSLM Marvel Bianco Dolomite London 5x30,5 - 2"x12"		ALSD Marvel Bianco Dolomite London A.E. 5x2,5 - 2"x1"		LSLN Marvel Nero Marquina London 5x30,5 - 2"x12"		ALSN Marvel Nero Marquina London A.E. 5x2,5 - 2"x1"
	LSSD Marvel Bianco Dolomite Spigolo 0,8x20 - 3 ¹ / ₈ "x7 ⁷ / ₈ "		AS1D Marvel Bianco Dolomite Spigolo A.E. 0,8x0,8 - 3 ¹ / ₈ "x ² / ₈ "		LSSN Marvel Nero Marquina Spigolo 0,8x20 - 3 ¹ / ₈ "x7 ⁷ / ₈ "		AS1N Marvel Nero Marquina Spigolo A.E. 0,8x0,8 - 3 ¹ / ₈ "x ² / ₈ "
	LSLE Marvel Cream Prestige London 5x30,5 - 2"x12"		ALSE Marvel Cream Prestige London A.E. 5x2,5 cm - 2"x1"				
	LSSE Marvel Cream Prestige Spigolo 0,8x20 - 3 ¹ / ₈ "x7 ⁷ / ₈ "		AS1E Marvel Cream Prestige Spigolo A.E. 0,8x0,8 - 3 ¹ / ₈ "x ² / ₈ "				





THE BRICK ATELIER

WALL TILES

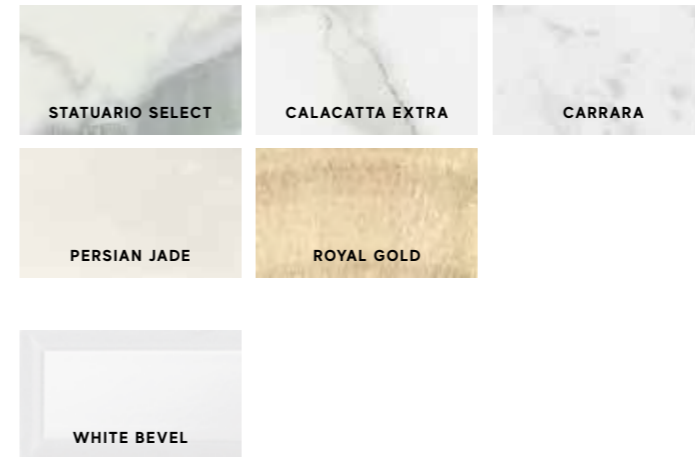

Wall tiles / Rivestimento

WHITEBODY WALL TILES - RECTIFIED MONOCALIBER
RIVESTIMENTI IN PASTA BIANCA - RETTIFICATO MONOCALIBRO

Sizes	Thickness	Surface finish
8x31,5 cm - 3 1/8" x 12 3/8"	± 8,5 mm ± 10 mm	Shiny



WHITEBODY WALL TILES | RIVESTIMENTI IN PASTA BIANCA | Revêtements en pâte blanche | Weißscherbige Wandfliesen | Revestimientos en pasta blanca | Настенная плитка из белой глины
RECTIFIED MONOCALIBER | RETTIFICATO MONOCALIBRO | Rectifié mono-calibre | Geschliffen einkalibrig | Rectificado monocalibré | Ретицированный в одном калибре

BRICK ATELIER Wall Tiles / Rivestimento

SHINY SURFACE / SUPERFICIE LUCIDA



LMKT Brick Statuario Select
8x31,5 - 3/8"x12 3/8"



LMKC Brick Calacatta Extra
8x31,5 - 3/8"x12 3/8"



AZA2 Brick Carrara
8x31,5 - 3/8"x12 3/8"



AZA3 Brick Persian Jade
8x31,5 - 3/8"x12 3/8"



AZA4 Brick Royal Gold
8x31,5 - 3/8"x12 3/8"

COORDINATED TRIM TILES / PEZZI SPECIALI IN ABBINAMENTO



LVLS Marvel Statuario Select London
5x30,5 - 2"x12"



ASDZ Marvel Calacatta London
5x30,5 - 2"x12"



AVLS Marvel London A.E.
5x2,5 - 2"x1"



ASD7 Marvel London A.E.
5x2,5 - 2"x1"

LVSS Marvel Statuario Select Spigolo
0,85x30,5 - 3/8"x12"

ASDM Marvel Calacatta Spigolo
0,85x30,5 - 3/8"x12"

AVSS Marvel Spigolo A.E.
0,85x0,85 - 3/8"x3/8"

ASEE Marvel Spigolo A.E.
0,85x0,85 - 3/8"x3/8"



LVAS Marvel Statuario Select Alzata
20x30,5 - 7/8"x12"



ASDG Marvel Calacatta Alzata
20x30,5 - 7/8"x12"



AVAA Marvel Alzata A.E.
1,5x20 - 3/8"x7 7/8"



ASDT Marvel Alzata A.E.
1,5x20 - 3/8"x7 7/8"



LMLJ Persian Jade London
5x31,5 - 2"x12 3/8"



LMLY Royal Gold London
5x31,5 - 2"x12 3/8"



LSLH Marvel Carrara London
5x30,5 - 2"x12"

LMSJ Brick Persian Jade Spigolo
0,8x31,5 - 3/8"x12 3/8"

LMSX Brick Royal Gold Spigolo
0,8x31,5 - 3/8"x12 3/8"

LDPI Dwell Ice Spigolo
0,8x20 cm - 3/8"x7 7/8"

A1DI Dwell Ice Spigolo A.E.
0,8x0,8 cm - 3/8"x3/8"



AZDA Brick White Bevel
8x31,5 - 3/8"x12 3/8"

COORDINATED DECORS / DECORI IN ABBINAMENTO

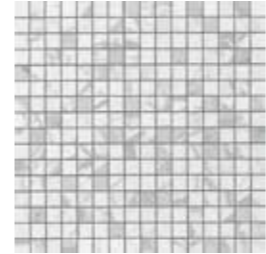

9MVS Marvel Statuario Select Mosaic
30,5x30,5 - 12"x12"

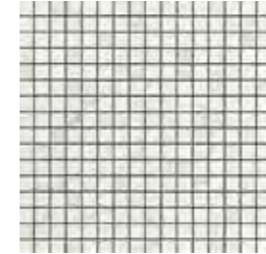

ASCM Marvel Calacatta Mosaic
30,5x30,5 - 12"x12"



ASDE Marvel Calacatta Fregio
10x30,5 - 3/8" x12"



ASEE Marvel Greca Gold •
7,8x30,5 - 3/8"x12"



ASEM Marvel Greca A.E. •
7,8x1,2 - 3/8"x1/2"

• **DECOR WITH GOLD INSERT.**
DECORO CON INSERTO IN ORO.
Décor avec insert en OR.
Dekor mit Einlage GOLD.
Decoración con aplicación de ORO.
Декор с ЗОЛОТОЙ вставкой.



**V3
MODERATE
VARIATION**
Statuario Select,
Calacatta Extra,
Persian Jade,
Royal Gold



**V2
SLIGHT
VARIATION**
Carrara,
Silver Dream,
Noir St. Laurent



**V1
UNIFORM
VARIATION**

SHINY SURFACE | SUPERFICIE LUCIDA | Surface brillante | Glänzende oberfläche | Superficie brillante | Глянцевая поверхность

359



AIX
PORCELAIN&WALL TILES



Porcelain Tiles / Gres Porcellanato

COLOURED BODY PORCELAIN TILES - RECTIFIED MONOCALIBER
GRES PORCELLANATO COLORATO IN MASSA - RETTIFICATO MONOCALIBRO

LARGE SIZES p. 500

Sizes	Thickness	Surface finish
120x120 cm - 47 ¹ / ₄ "x47 ¹ / ₄ "	± 9 mm	Matte R10 A+B
75x150 cm - 29 ¹ / ₂ "x59"	± 9 mm	Matte R10 A+B
75x75 cm - 29 ¹ / ₂ "x29 ¹ / ₂ "	± 9 mm	Matte R10 A+B
37,5x75 cm - 14 ³ / ₄ "x29 ¹ / ₂ "	± 9 mm	Matte R10 A+B

Outdoor Paving and Wet Areas

OUTDOOR PAVING p. 554

Sizes	Thickness	Surface finish
37,5x75 cm - 14 ³ / ₄ "x29 ¹ / ₂ "	± 9 mm	Grip R11 A+B+C
22,5x45,3 cm - 8 ⁷ / ₈ "x17 ³ / ₄ " > NON RECTIFIED - NON RETTIFICATO	± 9 mm	Textured R11 A+B+C
22,5x22,5 cm - 8 ⁷ / ₈ "x8 ⁷ / ₈ " > NON RECTIFIED - NON RETTIFICATO	± 9 mm	Textured R11 A+B+C
120x120 cm - 47 ¹ / ₄ "x47 ¹ / ₄ "	± 20 mm	Textured R11 A+B+C
60x90 cm - 23 ⁵ / ₈ "x35 ³ / ₈ "	± 20 mm	Textured R11 A+B+C
60x60 cm - 23 ⁵ / ₈ "x23 ⁵ / ₈ "	± 20 mm	Textured R11 A+B+C
22,5x45,4 cm - 8 ⁷ / ₈ "x17 ³ / ₄ " > NON RECTIFIED - NON RETTIFICATO	± 20 mm	Textured R11 A+B+C
22,5x22,5 cm - 8 ⁷ / ₈ "x8 ⁷ / ₈ " > NON RECTIFIED - NON RETTIFICATO	± 20 mm	Textured R11 A+B+C

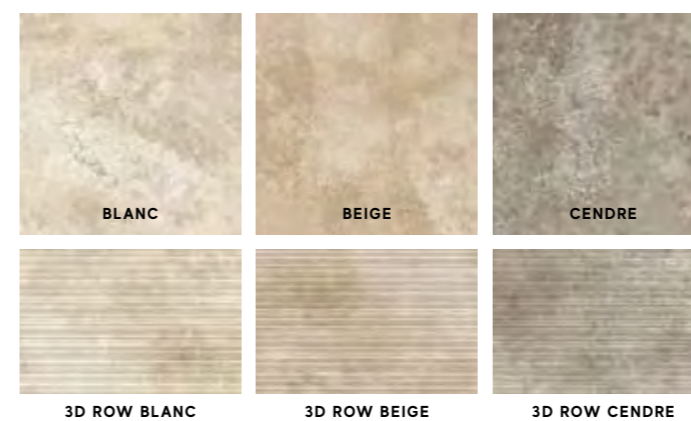

Wall Tiles / Rivestimento

WHITEBODY WALL TILES - RECTIFIED MONOCALIBER
RIVESTIMENTI IN PASTA BIANCA - RETTIFICATO MONOCALIBRO

Sizes	Thickness	Surface finish
40x80 cm - 15 ³ / ₄ "x31 ¹ / ₂ "	± 8,5 mm	Matte

3D Wall Tiles

Sizes	Thickness	Surface finish
40x80 cm - 15 ³ / ₄ "x31 ¹ / ₂ "	± 10 mm	Matte

AIX Porcelain Tiles / Gres Porcellanato

MATTE SURFACE / SUPERFICIE MATT

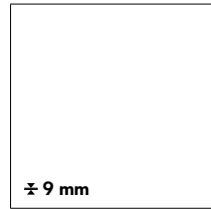

120x120 cm 47¹/₄"x47¹/₄"
 A05N Aix Blanc 120x120
 A05O Aix Beige 120x120
 A05Q Aix Cendre 120x120
 A05R Aix Fumée 120x120



75x150 cm 29¹/₂"x59"
 APR8 Aix Blanc 75x150
 APR9 Aix Beige 75x150
 APSA Aix Cendre 75x150
 APSB Aix Fumée 75x150

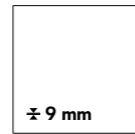

75x75 cm 29¹/₂"x29¹/₂"
 APSC Aix Blanc 75x75
 APSE Aix Beige 75x75
 APSE Aix Cendre 75x75
 APSF Aix Fumée 75x75

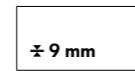

37,5x75 cm 14³/₈"x29¹/₂"
 AP5G Aix Blanc 37,5x75
 AP5I Aix Beige 37,5x75
 AP5J Aix Cendre 37,5x75
 AP5K Aix Fumée 37,5x75

GRIP SURFACE / SUPERFICIE GRIP

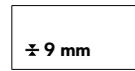

37,5x75 cm 14³/₈"x29¹/₂"
 AP5L Aix Blanc 37,5x75 Grip
 AP5M Aix Beige 37,5x75 Grip
 AP5O Aix Cendre 37,5x75 Grip
 AP5Q Aix Fumée 37,5x75 Grip

TEXTURED SURFACE / SUPERFICIE STRUTTURATA

NON RECTIFIED - NON RETTIFICATO

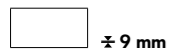

22,5x45,3 cm 8⁷/₈"x17³/₈"
 APST Aix Beige 22,5x45,3 Strutturato
 APSU Aix Cendre 22,5x45,3 Strutturato

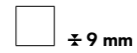

22,5x22,5 cm 8⁷/₈"x8⁷/₈"
 APSR Aix Beige 22,5x22,5 Strutturato
 APSS Aix Cendre 22,5x22,5 Strutturato

OUTDOOR PAVING ± 20 mm / PAVIMENTI DA ESTERNO ± 20 mm

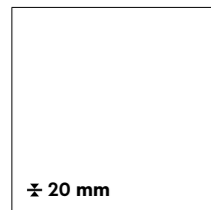

120x120 cm 47¹/₄"x47¹/₄"
 A07C Aix Blanc 120x120 20 mm
 A07E Aix Beige 120x120 20 mm
 A07F Aix Cendre 120x120 20 mm
 A07G Aix Fumée 120x120 20 mm



60x90 cm 23³/₈"x35³/₈"
 APS1 Aix Blanc 60x90 20 mm
 APS2 Aix Beige 60x90 20 mm
 APS4 Aix Cendre 60x90 20 mm
 APS5 Aix Fumée 60x90 20 mm



60x60 cm 23³/₈"x23³/₈"
 APSZ Aix Beige 60x60 20 mm
 APS0 Aix Cendre 60x60 20 mm



22,5x45,4 cm 8⁷/₈"x17³/₈"
 APR2 Aix Beige 22,5x45,4 20 mm
 APR3 Aix Cendre 22,5x45,4 20 mm

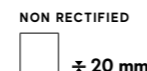

22,5x22,5 cm 8⁷/₈"x8⁷/₈"
 APR4 Aix Beige 22,5x22,5 20 mm
 APR5 Aix Cendre 22,5x22,5 20 mm



MATTE SURFACE | SUPERFICIE MATT | Surface Mat | Matt oberfläche | Superficie Mate | Матовая поверхность
 GRIP SURFACE | SUPERFICIE GRIP | Surface grip | Grip oberfläche | Superficie Grip | Grip поверхность
 TEXTURED SURFACE | SUPERFICIE STRUTTURATA | Surface structuré | Strukturiert oberfläche | Superficie estructurado | Структурная поверхность
 OUTDOOR PAVING | PAVIMENTI DA ESTERNO | Sols d'extérieur | Außenbeläge für Außenbereiche | Pavimentos para exteriores | Уличная плитка

MATTE / GRIP



BLANC



BEIGE



CENDRE



FUMÉE

OUTDOOR PAVING ± 20 mm

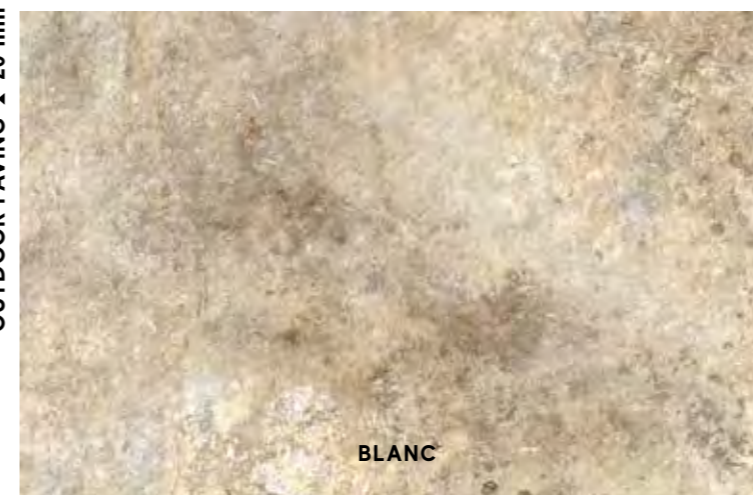

BLANC

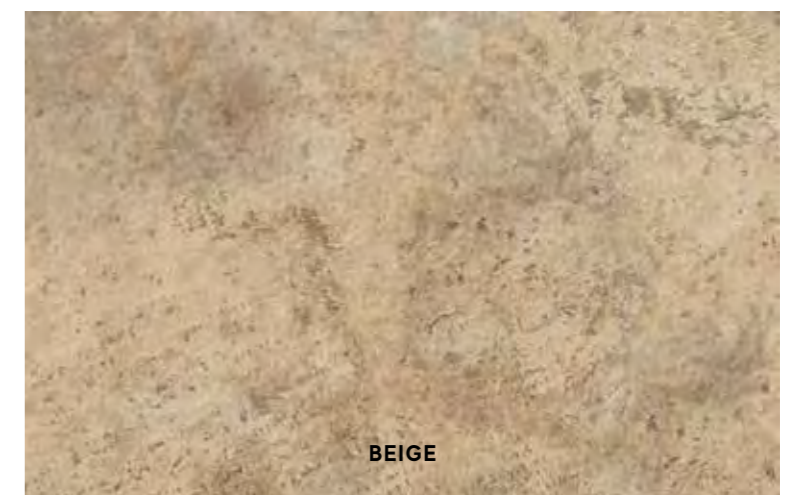

BEIGE



CENDRE

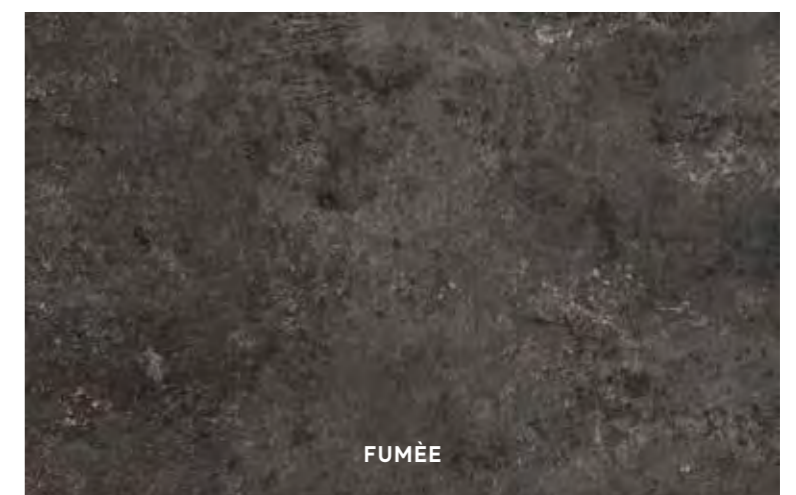

FUMÉE

STONE LOOK

STONE LOOK

AIX Porcelain Tiles / Gres Porcellanato

DECOR RANGE / GAMMA DECORI



A04X Aix Blanc Kit Multifornato Tumbled *

- 1 pcs 75x75 - 29 1/2" x 29 1/2"
- 1 pcs 50x75 - 19 5/8" x 29 1/2"
- 1 pcs 50x50 - 19 5/8" x 19 5/8"
- 3 pcs 25x50 - 9 7/8" x 19 5/8"
- 2 pcs 25x25 - 9 7/8" x 9 7/8"



A04Y Aix Beige Kit Multifornato Tumbled *

- 1 pcs 75x75 - 29 1/2" x 29 1/2"
- 1 pcs 50x75 - 19 5/8" x 29 1/2"
- 1 pcs 50x50 - 19 5/8" x 19 5/8"
- 3 pcs 25x50 - 9 7/8" x 19 5/8"
- 2 pcs 25x25 - 9 7/8" x 9 7/8"



A04Z Aix Cendre Kit Multifornato Tumbled *

- 1 pcs 75x75 - 29 1/2" x 29 1/2"
- 1 pcs 50x75 - 19 5/8" x 29 1/2"
- 1 pcs 50x50 - 19 5/8" x 19 5/8"
- 3 pcs 25x50 - 9 7/8" x 19 5/8"
- 2 pcs 25x25 - 9 7/8" x 9 7/8"



A05C Aix Fumée Kit Multifornato Tumbled *

- 1 pcs 75x75 - 29 1/2" x 29 1/2"
- 1 pcs 50x75 - 19 5/8" x 29 1/2"
- 1 pcs 50x50 - 19 5/8" x 19 5/8"
- 3 pcs 25x50 - 9 7/8" x 19 5/8"
- 2 pcs 25x25 - 9 7/8" x 9 7/8"

STONE LOOK

STONE LOOK

The miniatures of the Kit Multifornato are not in proportion. / I minimali nel Kit Multifornato non sono in proporzione. / Les illustrations à échelle réduite dans le Kit Multifornato ne sont pas proportionnelles. | Die Abbildungen im Kit Multifornato sind nicht verhältnismäßig. / Los miniaturas en el Kit Multifornato no están en proporción. / Изображения Kit Multifornato не соблюдают пропорций.

AIX Porcelain Tiles / Gres Porcellanato

DECOR RANGE / GAMMA DECORI



A0UA AIX Blanc
Honeycomb Tumbled
30x31- 11³/₄"x12¹/₄"



A0UB AIX Beige
Honeycomb Tumbled
30x31- 11³/₄"x12¹/₄"



A0UC AIX Cendre
Honeycomb Tumbled
30x31- 11³/₄"x12¹/₄"



A0UD AIX Fumée
Honeycomb Tumbled
30x31- 11³/₄"x12¹/₄"

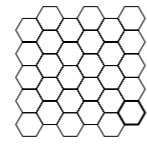

6,7x5,8 cm
2¹/₈"x2¹/₈"



A0TZ AIX Blanc
Mosaico Tumbled *
30x30 - 11³/₄"x11³/₄"



A0T0 AIX Beige
Mosaico Tumbled *
30x30 - 11³/₄"x11³/₄"



A0T8 AIX Cendre
Mosaico Tumbled *
30x30 - 11³/₄"x11³/₄"



A0T9 AIX Fumée
Mosaico Tumbled *
30x30 - 11³/₄"x11³/₄"

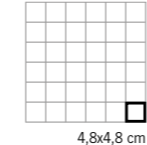

4,8x4,8 cm
1⁷/₈"x1⁷/₈"



A0UE AIX Blanc
Brick Tumbled *
37x37 - 14⁵/₈"x14⁵/₈"



A0UF AIX Beige
Brick Tumbled *
37x37 - 14⁵/₈"x14⁵/₈"



A0UG AIX Cendre
Mosaico Tumbled *
37x37 - 14⁵/₈"x14⁵/₈"



A0UH AIX Fumée
Mosaico Tumbled *
37x37 - 14⁵/₈"x14⁵/₈"

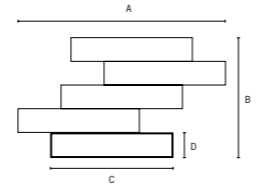

A 62,7 cm - 24³/₈"
B 36,7 cm - 14¹/₂"
C 36,65 cm - 14⁹/₁₆"
D 7,15 cm - 2⁷/₁₆"



TRIM TILES / PEZZI SPECIALI

UPEC p. 595

	Battiscopa 7,2x75 - 2 ⁷ / ₈ "x29 ¹ / ₂ "	Gradino * 37,5x75 - 14 ³ / ₄ "x29 ¹ / ₂ "	Scalino *			Scalino Angolare *		Battiscopa Sag. Scala 7,2x30 - 2 ⁷ / ₈ "x11 ³ / ₄ "		Elemento L Grip * 15x75 H. 4 - 5 ⁷ / ₈ "x29 ¹ / ₂ "	Elemento L Strutturato * 15x30 H. 3,5 - 5 ⁷ / ₈ "x11 ³ / ₄ "
			37,5x150 - 14 ³ / ₄ "x59"	33x120 - 13"x47 ¹ / ₄ "	37,5x75 - 14 ³ / ₄ "x29 ¹ / ₂ "	Scalino Angolare * 37,5x37,5 - 14 ³ / ₄ "x14 ³ / ₄ "	Scalino Angolare * 33x33 - 13"x13"	DX *	SX *		
Blanc	A0SF	A0SR	A0SV	A0ST	A0SZ	A0TJ	A0SY	A0SJ	A0SN	A0TR	-
Beige	A0SG	A0SS	A0SW	A0SU	A0S0	A0TK	A0SX	A0SK	A0SO	A0TS	A0TW
Cendre	A0SH	A0ST	A0SX	A0SV	A0S8	A0TP	A0SZ	A0SL	A0SP	A0TT	A0TX
Fumée	A0SI	A0SU	A0SY	A0SW	A0S9	A0TQ	A06J	A0SM	A0SQ	A0TU	-

* THESE PARTS ARE SUPPLIED TO ORDER | I PEZZI SONO DISPONIBILI SU ORDINAZIONE | Les pièces sont disponibles sur commande | Die Teile sind auf Bestellung lieferbar | Las piezas se hacen por encargo | Изготавливаются на заказ

STONE LOOK

STONE LOOK



AIX
WALL TILES

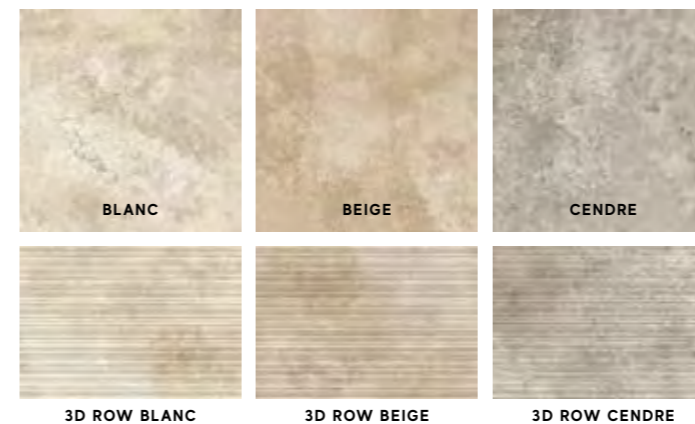

Wall Tiles / Rivestimento

WHITEBODY WALL TILES - RECTIFIED MONOCALIBER
RIVESTIMENTI IN PASTA BIANCA - RETTIFICATO MONOCALIBRO

Sizes	Thickness	Surface finish
40x80 cm - 15 ³ / ₄ "x31 ¹ / ₂ "	± 8,5 mm	Matte

3D Wall Tiles

Sizes	Thickness	Surface finish
40x80 cm - 15 ³ / ₄ "x31 ¹ / ₂ "	± 10 mm	Matte

DECORATIVE RANGE / GAMMA DECORATIVA



MINIBRICK



atlas concorde

WHITEBODY WALL TILES | RIVESTIMENTI IN PASTA BIANCA | Revêtements en pâte blanche | Weißscherbige Wandfliesen | Revestimientos en pasta blanca | Настенная плитка из белой глины
RECTIFIED MONOCALIBER | RETTIFICATO MONOCALIBRO | Rectifié mono-calibre | Geschliffen einkalibrig | Rectificado monocalibré | Ретицированный в одном калибре

AIX Wall Tiles / Rivestimento

MATTE SURFACE / SUPERFICIE MATT



8AIB Aix Blanc 40x80
40x80 cm - 15³/₄"x31¹/₂"



8AIE Aix Beige 40x80
40x80 cm - 15³/₄"x31¹/₂"



8AIC Aix Cendre 40x80
40x80 cm - 15³/₄"x31¹/₂"

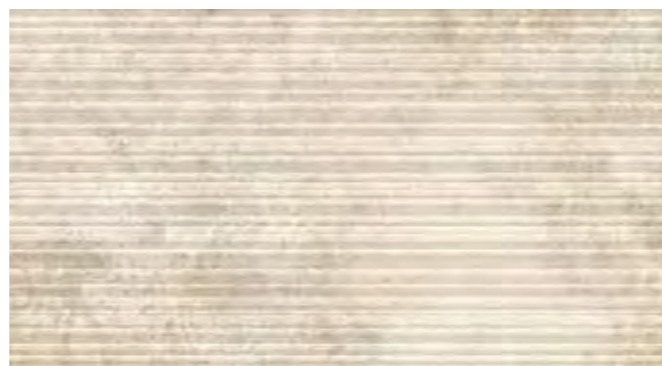

8A3B Aix 3D Row Blanc 40x80
40x80 cm - 15³/₄"x31¹/₂"



8A3E Aix 3D Row Beige 40x80
40x80 cm - 15³/₄"x31¹/₂"



8A3C Aix 3D Row Cendre 40x80
40x80 cm - 15³/₄"x31¹/₂"



V2
SLIGHT
VARIATION

AIX Wall Tiles / Rivestimento

DECOR RANGE / GAMMA DECORI



9AKB Aix Blanc
Minibrick Tumbled *
30,5x30,5 - 12"x12"



9AKE Aix Beige
Minibrick Tumbled *
30,5x30,5 - 12"x12"



9AKC Aix Cendre
Minibrick Tumbled *
30,5x30,5 - 12"x12"

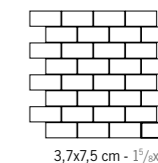

TRIM TILES / PEZZI SPECIALI

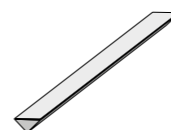

1,4x40 cm - 5/8"x15³/₄"

- LAII Aix Blanc Corner 40 *
- LAIC Aix Cendre Corner 40 *
- LAIE Aix Beige Corner 40 *
- LA3B Aix 3D Blanc Corner 40 *
- LA3C Aix 3D Cendre Corner 40 *
- LA3E Aix 3D Beige Corner 40 *



1,4x1,4 cm - 5/8"x5/8"

- A0IB Aix Blanc Corner A.E. 1,4 *
- A0IC Aix Cendre Corner A.E. 1,4 *
- A0IE Aix Beige Corner A.E. 1,4 *

* THESE PARTS ARE SUPPLIED TO ORDER . I PEZZI SONO DISPONIBILI SU ORDINAZIONE
Les pièces sont disponibles sur commande | Die Teile sind auf Bestellung lieferbar | Las piezas se hacen por encargo | Изготавливаются на заказ



* Tumbled / Burattato / Tamisé / Genarbt / Tamboreado / Выщербленный



brave

PORCELAIN&WALL TILES



Porcelain Tiles / Gres Porcellanato

COLOURED BODY PORCELAIN TILES - RECTIFIED MONOCALIBER
GRES PORCELLANATO COLORATO IN MASSA - RETTIFICATO MONOCALIBRO

Sizes	Thickness	Surface finish
75x150 cm - 29 ¹ / ₂ "x59"	± 9 mm	Matte R10 A+B
75x75 cm - 29 ¹ / ₂ "x29 ¹ / ₂ "	± 9 mm	Matte R10 A+B
45x90 cm - 17 ³ / ₄ "x35 ³ / ₈ "	± 9 mm	Matte R10 A+B
60x60 cm - 23 ⁵ / ₈ "x23 ⁵ / ₈ "	± 9 mm	Matte R10 A+B
30x60 cm - 11 ³ / ₄ "x23 ⁵ / ₈ "	± 9 mm	Matte R10 A+B

Outdoor Paving and Wet Areas

OUTDOOR PAVING p. 554

Sizes	Thickness	Surface finish
30x60 cm - 11 ³ / ₄ "x23 ⁵ / ₈ "	± 9 mm	Grip R12 A+B+C
120x120 cm - 47 ¹ / ₄ "x47 ¹ / ₄ "	± 20 mm	Textured R11 A+B+C
60x120 cm - 23 ⁵ / ₈ "x47 ¹ / ₄ "	± 20 mm	Textured R11 A+B+C
60x60 cm - 23 ⁵ / ₈ "x23 ⁵ / ₈ "	± 20 mm	Textured R11 A+B+C
45x90 cm - 17 ³ / ₄ "x35 ³ / ₈ "	± 20 mm	Textured R11 A+B+C
30x60 cm - 11 ³ / ₄ "x23 ⁵ / ₈ "	± 20 mm	Textured R11 A+B+C



Wall Tiles / Rivestimento

WHITEBODY WALL TILES - RECTIFIED MONOCALIBER
RIVESTIMENTI IN PASTA BIANCA - RETTIFICATO MONOCALIBRO

Sizes	Thickness	Surface finish
40x80 cm - 15 ³ / ₄ "x31 ¹ / ₂ "	± 8,5 mm	Matte

3D Wall Tiles

Sizes	Thickness	Surface finish
40x80 cm - 15 ³ / ₄ "x31 ¹ / ₂ "	± 10 mm	Matte

BRAVE Porcelain Tiles / Gres Porcellanato

MATTE SURFACE / SUPERFICIE MATT



75x150 cm 29 1/2"x59"
 AXAO Brave Gypsum 75x150
 AXAP Brave Pearl 75x150
 AXAQ Brave Grey 75x150
 AXAR Brave Earth 75x150
 AXAS Brave Coke 75x150

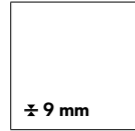

75x75 cm 29 1/2"x29 1/2"
 AXAJ Brave Gypsum 75x75
 AXAK Brave Pearl 75x75
 AXAL Brave Grey 75x75
 AXAM Brave Earth 75x75
 AXAN Brave Coke 75x75

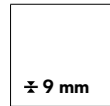

60x60 cm 23 3/8"x23 3/8"
 AW9U Brave Gypsum 60x60
 AW9V Brave Pearl 60x60
 AW9W Brave Grey 60x60
 AW9X Brave Earth 60x60
 AW9Y Brave Coke 60x60

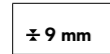

30x60 cm 11 3/4"x23 3/8"
 D046 Brave Gypsum 30x60
 D047 Brave Pearl 30x60
 D048 Brave Grey 30x60
 D049 Brave Earth 30x60
 D050 Brave Coke 30x60



45x90 cm 17 3/4"x35 3/8"
 AXAE Brave Gypsum 45x90
 AXAF Brave Pearl 45x90
 AXAG Brave Grey 45x90
 AXAH Brave Earth 45x90
 AXAI Brave Coke 45x90

GRIP SURFACE / SUPERFICIE GRIP

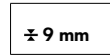

30x60 cm 11 3/4"x23 3/8"
 D051 Brave Gypsum 30x60 Grip
 D052 Brave Pearl 30x60 Grip
 D053 Brave Grey 30x60 Grip
 D054 Brave Earth 30x60 Grip
 D055 Brave Coke 30x60 Grip

OUTDOOR PAVING ± 20 mm / PAVIMENTI DA ESTERNO ± 20 mm

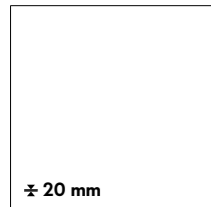

120x120 cm 47 1/4"x47 1/4"
 AOX9 Brave Grey 120x120 LASTRA 20mm
 AOYA Brave Coke 120x120 LASTRA 20mm

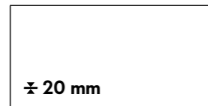

60x120 cm 23 3/8"x47 1/4"
 AT5I Brave Gypsum 60x120 LASTRA 20mm
 AT5J Brave Pearl 60x120 LASTRA 20mm
 AT5K Brave Grey 60x120 LASTRA 20mm
 AT5L Brave Earth 60x120 LASTRA 20mm
 AT5M Brave Coke 60x120 LASTRA 20mm

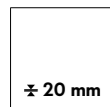

60x60 cm 23 3/8"x23 3/8"
 AXAT Brave Gypsum 60x60 LASTRA 20mm
 AXAU Brave Pearl 60x60 LASTRA 20mm
 AXAV Brave Grey 60x60 LASTRA 20mm
 AXAW Brave Earth 60x60 LASTRA 20mm
 AXAX Brave Coke 60x60 LASTRA 20mm

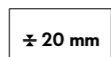

30x60 cm 11 3/4"x23 3/8"
 ATZ1 Brave Gypsum 30x60 LASTRA 20mm
 ATZ2 Brave Pearl 30x60 LASTRA 20mm
 ATZ3 Brave Grey 30x60 LASTRA 20mm
 ATZ4 Brave Earth 30x60 LASTRA 20mm
 ATZ6 Brave Coke 30x60 LASTRA 20mm

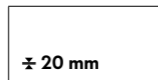

45x90 cm 17 3/4"x35 3/8"
 AXAY Brave Gypsum 45x90 LASTRA 20mm
 AXAZ Brave Pearl 45x90 LASTRA 20mm
 AXBA Brave Grey 45x90 LASTRA 20mm
 AXBB Brave Earth 45x90 LASTRA 20mm
 AXBC Brave Coke 45x90 LASTRA 20mm



V2
 SLIGHT
 VARIATION

MATTE / GRIP

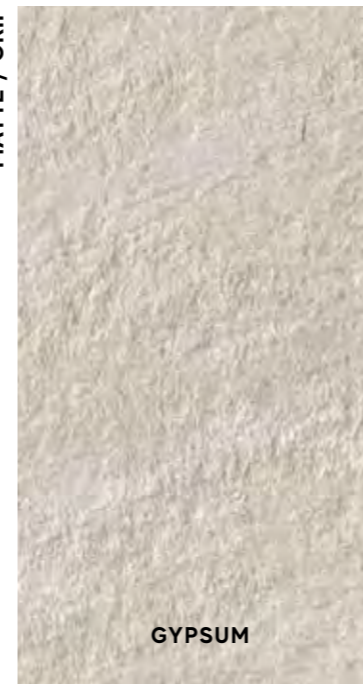

GYPSUM



PEARL

OUTDOOR PAVING ± 20 mm



GYPSUM



PEARL

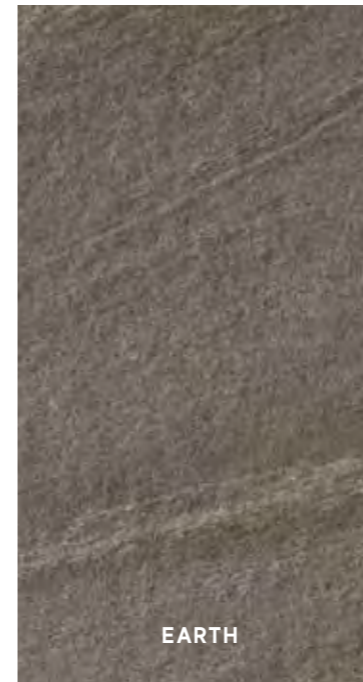

EARTH



GREY



EARTH



GREY



COKE



COKE

BRAVE Porcelain Tiles / Gres Porcellanato

DECOR RANGE / GAMMA DECORI

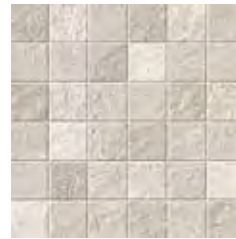

A1FM Brave Gypsum Mosaico
30x30 - 11³/₄"x11³/₄"

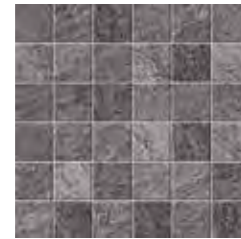

A1FO Brave Grey Mosaico
30x30 - 11³/₄"x11³/₄"



A1FQ Brave Coke Mosaico
30x30 - 11³/₄"x11³/₄"



A1FN Brave Pearl Mosaico
30x30 - 11³/₄"x11³/₄"

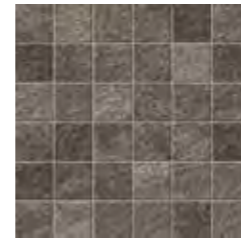

A1FP Brave Earth Mosaico
30x30 - 11³/₄"x11³/₄"

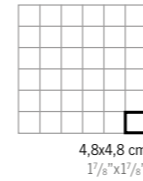

4,8x4,8 cm
1⁷/₈"x1⁷/₈"



A1FW Brave Gypsum Industrial 3D *
44x28,5 - 17³/₈"x11¹/₄"



A1FY Brave Grey Industrial 3D *
44x28,5 - 17³/₈"x11¹/₄"



A1FØ Brave Coke Industrial 3D *
44x28,5 - 17³/₈"x11¹/₄"

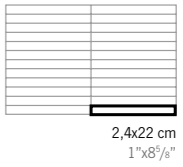

2,4x2,2 cm
1"x8¹/₂"



A1FX Brave Pearl Industrial 3D *
44x28,5 - 17³/₈"x11¹/₄"



A1FZ Brave Earth Industrial 3D *
44x28,5 - 17³/₈"x11¹/₄"

* **MULTI-THICKNESS MOSAIC, CLOSE JOINT INSTALLATION WITHOUT GROUTING.**
MOSAICO MULTISPESORE, POSA SENZA STUCCATURA A GIUNTO UNITO.
Mosaïque multi-épaisseur, pose sans mastic avec joint nul.
Mosaik mit verschiedener Stärken, fugenlose Verlegung ohne Mörtel.
Mosaico multiespesor, colocación sin mástique y sin juntas.
Мозаика разной толщины; укладка встык без затирки швов.



A1F1 Brave Gypsum Brick 3D *
29x59 - 11³/₈"x23¹/₄"



A1F2 Brave Pearl Brick 3D *
29x59 - 11³/₈"x23¹/₄"



A1F3 Brave Grey Brick 3D *
29x59 - 11³/₈"x23¹/₄"



A1F4 Brave Earth Brick 3D *
29x59 - 11³/₈"x23¹/₄"



A1F5 Brave Coke Brick 3D *
29x59 - 11³/₈"x23¹/₄"

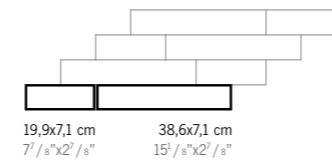

19,9x7,1 cm
7⁷/₈"x2⁷/₈"
38,6x7,1 cm
15¹/₈"x2⁷/₈"



A1X5 Brave Gypsum Listello 8x60
8x60 - 3¹/₈"x23⁵/₈"



A1X4 Brave Grey Listello 8x60
8x60 - 3¹/₈"x23⁵/₈"



A1X2 Brave Coke Listello 8x60
8x60 - 3¹/₈"x23⁵/₈"



A1X6 Brave Pearl Listello 8x60
8x60 - 3¹/₈"x23⁵/₈"



A1X3 Brave Earth Listello 8x60
8x60 - 3¹/₈"x23⁵/₈"



TRIM TILES / PEZZI SPECIALI

p. 568

UPECE p. 595

	Battiscopa 7,2x60 2 ⁷ / ₈ "x23 ⁵ / ₈ "	Gradino * 30x60 11 ³ / ₄ "x23 ⁵ / ₈ "	Scalino * 33x150 13"x59"	Scalino *			Scalino Angolare 33x33 - 13"x13"		Battiscopa Sag. Scala 7,2x30 - 2 ⁷ / ₈ "x11 ³ / ₄ "		Elemento L Grip * 15x60 H. 4 5 ⁷ / ₈ "x23 ⁵ / ₈ "
				Scalino * 33x90 13"x35 ⁵ / ₈ "	Scalino * 33x75 13"x29 ¹ / ₂ "	Scalino * 33x60 13"x23 ⁵ / ₈ "	DX *	SX *	DX *	SX *	
Gypsum	A1IE	A1IJ	AZT9	A1IP	A1IU	A1IZ	A1JA	A1I4	A1JK	A1JF	A1JP
Pearl	A1IF	A1IL	AZUA	A1IQ	A1IV	A1IØ	A1JB	A1I5	A1JL	A1JG	A1JQ
Grey	A1IG	A1IM	AIZQ	A1IR	A1IW	A1I1	A1JC	A1I6	A1JM	A1JH	A1JR
Earth	A1IH	A1IN	AZUB	A1IS	A1IX	A1I2	A1JD	A1I7	A1JN	A1JI	A1JS
Coke	A1II	A1IO	AZEW	A1IT	A1IY	A1I3	A1JE	A1I8	A1JO	A1JJ	A1JT

* THESE PARTS ARE SUPPLIED TO ORDER | I PEZZI SONO DISPONIBILI SU ORDINAZIONE | Les pièces sont disponibles sur commande | Die Teile sind auf Bestellung lieferbar | Las piezas se hacen por encargo | Изготавливаются на заказ

THE DECORATION CAN ONLY BE LAID ON THE WALL | IL DECORO SI PUÒ POSARE SOLO A RIVESTIMENTO
Décor uniquement mural | Das Dekor kann nur an der Wand verlegt werden | La decoración se puede colocar únicamente en paredes | Декор может быть уложен только на стену.

STONE LOOK

STONE LOOK

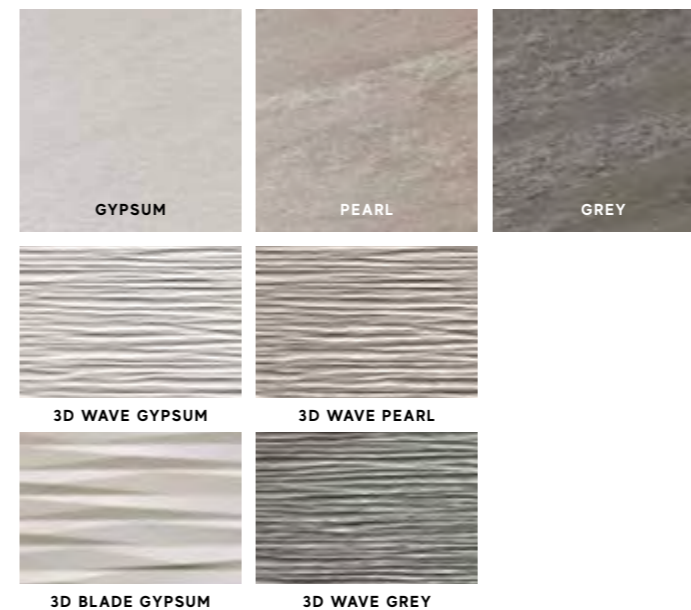

DECORATIVE RANGE / GAMMA DECORATIVA

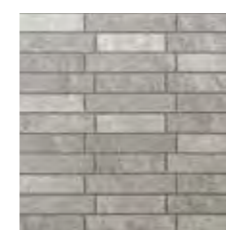

MOSAIC

Wall Tiles / Rivestimento

WHITEBODY WALL TILES - RECTIFIED MONOCALIBER
RIVESTIMENTI IN PASTA BIANCA - RETTIFICATO MONOCALIBRO

Sizes	Thickness	Surface finish
40x80 cm - 15 ³ / ₄ "x31 ¹ / ₂ "	± 8,5 mm	Matte

3D Wall Tiles

Sizes	Thickness	Surface finish
40x80 cm - 15 ³ / ₄ "x31 ¹ / ₂ "	± 10 mm	Matte



WHITEBODY WALL TILES | RIVESTIMENTI IN PASTA BIANCA | Revêtements en pâte blanche | Weißscherbige Wandfliesen | Revestimientos en pasta blanca | Настенная плитка из белой глины
RECTIFIED MONOCALIBER | RETTIFICATO MONOCALIBRO | Rectifié mono-calibre | Geschliffen einkalibrig | Rectificado monocalibre | Ретицированный в одном калибре

BRAVE Wall Tiles / Rivestimento

MATTE SURFACE / SUPERFICIE MATT



8BWU Brave Gypsum 40x80
40x80 cm - 15³/₄"x31¹/₂"



8BWL Brave Pearl 40x80
40x80 cm - 15³/₄"x31¹/₂"



8BWW Brave Grey 40x80
40x80 cm - 15³/₄"x31¹/₂"

TRIM TILES / PEZZI SPECIALI

LBSU Brave Gypsum Spigolo 0,8
0,8x20 cm - ³/₈"x7⁷/₈"

A1BU Brave Gypsum Spigolo 0,8 A.E.
0,8x0,8 cm - ³/₈"x³/₈"

LBSL Brave Pearl Spigolo 0,8
0,8x20 cm - ³/₈"x7⁷/₈"

A1BL Brave Pearl Spigolo 0,8 A.E.
0,8x0,8 cm - ³/₈"x³/₈"

LBSE Brave Grey Spigolo 0,8
0,8x20 cm - ³/₈"x7⁷/₈"

A1BR Brave Grey Spigolo 0,8 A.E.
0,8x0,8 cm - ³/₈"x³/₈"

DECOR RANGE / GAMMA DECORI



9BBG Brave Gypsum Mosaic
30,5x30,5 - 12"x12"



9BBP Brave Pearl Mosaic
30,5x30,5 - 12"x12"



9BBE Brave Grey Mosaic
30,5x30,5 - 12"x12"

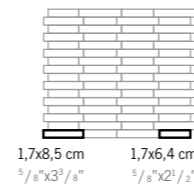

V2
SLIGHT
VARIATION

BRAVE 3D Wall Tiles / Rivestimento 3D

MATTE SURFACE / SUPERFICIE MATT



8BDG Brave 3D/Wave Gypsum 40x80
40x80 cm - 15³/₄"x31¹/₂"



8BDP Brave 3D/Wave Pearl 40x80
40x80 cm - 15³/₄"x31¹/₂"



8BBG Brave 3D/Blade Gypsum 40x80
40x80 cm - 15³/₄"x31¹/₂"



8BDE Brave 3D/Wave Grey 40x80
40x80 cm - 15³/₄"x31¹/₂"

TRIM TILES / PEZZI SPECIALI

LB1G Brave Gypsum Spigolo 10mm *
1x20 cm - ³/₈"x7⁷/₈"

LB1R Brave Pearl Spigolo 10mm *
1x20 cm - ³/₈"x7⁷/₈"

LB1E Brave Grey Spigolo 10mm *
1x20 cm - ³/₈"x7⁷/₈"

* THESE PARTS ARE SUPPLIED TO ORDER . I PEZZI SONO DISPONIBILI SU ORDINAZIONE
Les pièces sont disponibles sur commande | Die Teile sind auf Bestellung lieferbar | Las piezas se hacen por encargo | Изготавливаются на заказ



The 10 mm edge matches three-dimensional wall tiles having a 10-11 mm thickness / Lo spigolo 10 mm si abbina a rivestimenti tridimensionali di spessore 10-11 mm / Le bord 10 mm s'adapte aux revêtements tridimensionnels épaisseur 10-11 mm / Die 10 mm Kante ist mit dreidimensionalen Wandfliesen mit einer Dicke von 10-11 mm kombinierbar / La arista de 10 mm se combina con revestimientos tridimensionales de 10-11 mm de grosor / Угловой элемент 10 мм сочетается с трехмерной настенной плиткой толщиной 10-11 мм

MATTE SURFACE | SUPERFICIE MATT | Surface Mat | Matt oberfläche | Superficie Mate | Матовая поверхность

V2
SLIGHT
VARIATION



DOLMEN PRO

PORCELAIN TILES

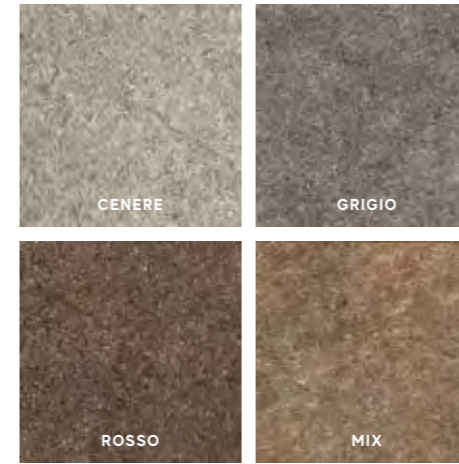

Porcelain Tiles / Gres Porcellanato

COLOURED BODY PORCELAIN TILES - RECTIFIED MONOCALIBER
GRES PORCELLANATO COLORATO IN MASSA - RETTIFICATO MONOCALIBRO

LARGE SIZES p. 500

Sizes	Thickness	Surface finish
162x324 cm - 63 ³ / ₄ "x127 ¹ / ₂ " > NON RECTIFIED - NON RETTIFICATO	± 6, 12, 20 mm	Flamed
75x150 cm - 29 ¹ / ₂ "x59"	± 9 mm	Matte R10 A+B
75x75 cm - 29 ¹ / ₂ "x29 ¹ / ₂ "	± 9 mm	Matte R10 A+B
37,5x75 cm - 14 ³ / ₄ "x29 ¹ / ₂ "	± 9 mm	Matte R10 A+B

Outdoor Paving and Wet Areas

OUTDOOR PAVING p. 554

Sizes	Thickness	Surface finish
37,5x75 cm - 14 ³ / ₄ "x29 ¹ / ₂ "	± 9 mm	Grip R11 A+B+C
22,5x45,3 cm - 8 ⁷ / ₈ "x17 ³ / ₄ " > NON RECTIFIED - NON RETTIFICATO	± 9 mm	Textured R11 A+B+C
22,5x22,5 cm - 8 ⁷ / ₈ "x8 ⁷ / ₈ " > NON RECTIFIED - NON RETTIFICATO	± 9 mm	Textured R11 A+B+C
60x120 cm - 23 ⁵ / ₈ "x47 ¹ / ₄ "	± 20 mm	Textured R11 A+B+C
22,5x45,4 cm - 8 ⁷ / ₈ "x17 ³ / ₄ " > NON RECTIFIED - NON RETTIFICATO	± 20 mm	Textured R11 A+B+C
22,5x22,5 cm - 8 ⁷ / ₈ "x8 ⁷ / ₈ " > NON RECTIFIED - NON RETTIFICATO	± 20 mm	Textured R11 A+B+C



COLOURED BODY PORCELAIN TILES | GRES PORCELLANATO COLORATO IN MASSA | Grés céramé coloré dans la masse | Durchgefärbtes Feinsteinzeug | Gres porcelánico coloreado en masa | Керамический гранит окрашенный в массе
RECTIFIED MONOCALIBER | RETTIFICATO MONOCALIBRO | Rectifié mono-calibre | Geschliffen einkalibrig | Rettificato monocallibre | Ретифицированный в одном калибре
NON RECTIFIED | NON RETTIFICATO | Non rectifié | Nicht rektifiziert | No rectificada | Неретифицированные

DOLMEN PRO Porcelain Tiles / Gres Porcellanato

MATTE SURFACE / SUPERFICIE MATT

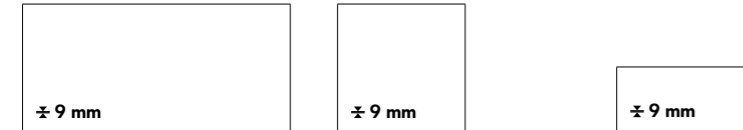

75x150 cm 29 1/2"x59"

APCX Dolmen Pro Cenere 75x150
APCZ Dolmen Pro Grigio 75x150
APCY Dolmen Pro Rosso 75x150

75x75 cm 29 1/2"x29 1/2"

APP0 Dolmen Pro Cenere 75x75
APP1 Dolmen Pro Grigio 75x75
APP3 Dolmen Pro Rosso 75x75

37,5x75 cm 14 3/4"x29 1/2"

APP4 Dolmen Pro Cenere 37,5x75
APP5 Dolmen Pro Grigio 37,5x75
APP6 Dolmen Pro Rosso 37,5x75
APP7 Dolmen Pro Mix 37,5x75

atlasPLAN p. 500



FLAMED / FLAMED

162x324 cm 63 3/4"x127 1/2"

> **NON RECTIFIED / NON RETTIFICATO**

AZYD Dolmen Pro Grigio Flamed ± 6 mm ST *
A0X8 Dolmen Pro Grigio Flamed ± 12 mm ST *
A2XP Dolmen Pro Grigio Flamed ± 20 mm



MATTE / GRIP

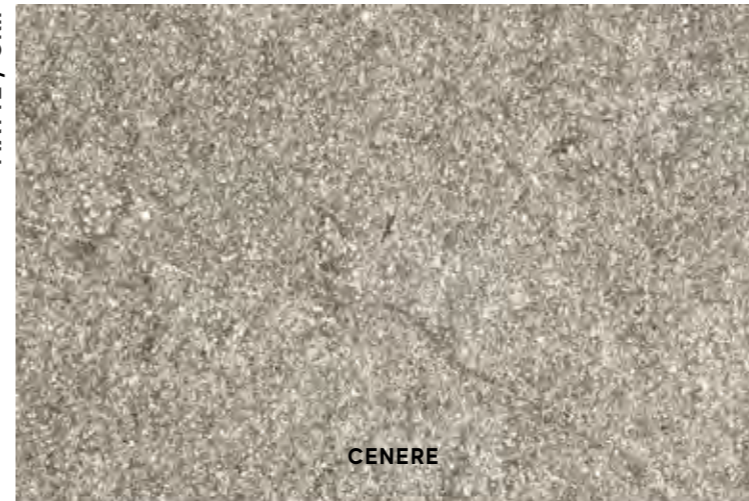

GRIP SURFACE / SUPERFICIE GRIP

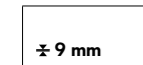

37,5x75 cm 14 3/4"x29 1/2"

APP8 Dolmen Pro Cenere 37,5x75 Grip
APP9 Dolmen Pro Grigio 37,5x75 Grip
APQA Dolmen Pro Rosso 37,5x75 Grip
APQB Dolmen Pro Mix 37,5x75 Grip

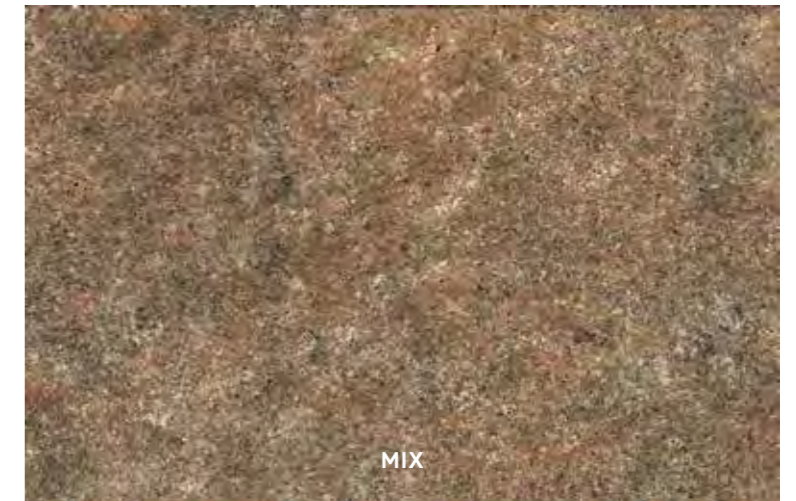
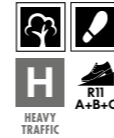

TEXTURED SURFACE / SUPERFICIE STRUTTURATA

NON RECTIFIED - NON RETTIFICATO

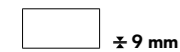

22,5x45,3 cm 8 7/8"x17 3/4"

APQG Dolmen Pro Cenere 22,5x45,3 Strutturato
APQH Dolmen Pro Grigio 22,5x45,3 Strutturato
APQI Dolmen Pro Rosso 22,5x45,3 Strutturato
APQJ Dolmen Pro Mix 22,5x45,3 Strutturato

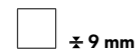

22,5x22,5 cm 8 7/8"x8 7/8"

APQC Dolmen Pro Cenere 22,5x22,5 Strutturato
APQD Dolmen Pro Grigio 22,5x22,5 Strutturato
APQE Dolmen Pro Rosso 22,5x22,5 Strutturato
APQF Dolmen Pro Mix 22,5x22,5 Strutturato

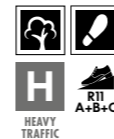

TEXTURED / OUTDOOR PAVING ± 20 mm



OUTDOOR PAVING ± 20 mm / PAVIMENTI DA ESTERNO ± 20 mm



60x120 cm 23 5/8"x47 1/4"

APQP Dolmen Pro Cenere 60x120 20 mm
APQQ Dolmen Pro Grigio 60x120 20 mm
APQS Dolmen Pro Rosso 60x120 20 mm

NON RECTIFIED



22,5x45,4 cm 8 7/8"x17 3/4"

APQK Dolmen Pro Rosso 22,5x45,4 20 mm
APQL Dolmen Pro Mix 22,5x45,4 20 mm

NON RECTIFIED

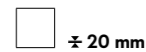

22,5x22,5 cm 8 7/8"x8 7/8"

APQN Dolmen Pro Rosso 22,5x22,5 20 mm
APQO Dolmen Pro Mix 22,5x22,5 20 mm



V2 SLIGHT VARIATION
Cenere,
Grigio,
Rosso



V4 SUBSTANTIAL VARIATION
Mix



MATTE SURFACE | SUPERFICIE MATT | Surface Mat | Matt oberfläche | Superficie Mate | Матовая поверхность
TEXTURED SURFACE | SUPERFICIE STRUTTURATA | Surface structuré | Strukturiert oberfläche | Superficie estruturado | Структурная поверхность
GRIP SURFACE | SUPERFICIE GRIP | Surface grip | Grip oberfläche | Superficie Grip | Grip поверхность
OUTDOOR PAVING | PAVIMENTI DA ESTERNO | Sols d'extérieur | Außenbeläge für Außenbereiche | Pavimentos para exteriores | Уличная плитка
* **WITH FIBERGLASS MESH** | VERSIONE STUOIATA | Version à nattes | Ausführung mit Glasfasermatte | Versión con malla | С упрочнением из стекловолоконка
NON RECTIFIED | NON RETTIFICATO | Non rectifié | Nicht rektifiziert | No rectificada | Неретифицированные

STONE LOOK

STONE LOOK

DOLMEN PRO Porcelain Tiles / Gres Porcellanato

DECOR RANGE / GAMMA DECORI

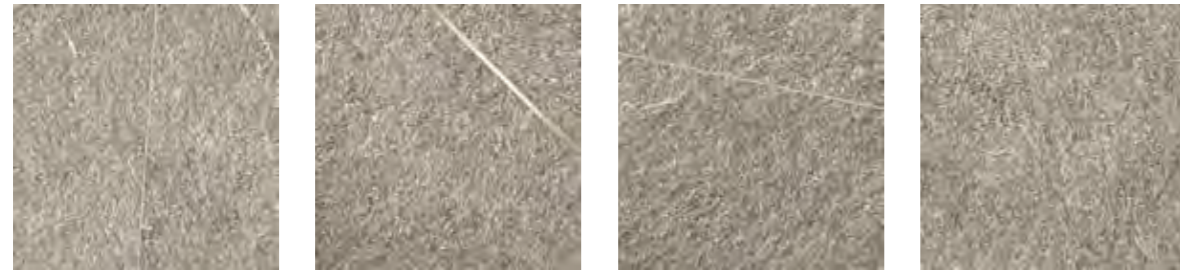

A02X Dolmen Pro Cenere
Squares Mix 4 *
34x34 - 13³/₈"x13³/₈"



A02Y Dolmen Pro Grigio
Squares Mix 4 *
34x34 - 13³/₈"x13³/₈"



A02Z Dolmen Pro Rosso
Squares Mix 4 *
34x34 - 13³/₈"x13³/₈"

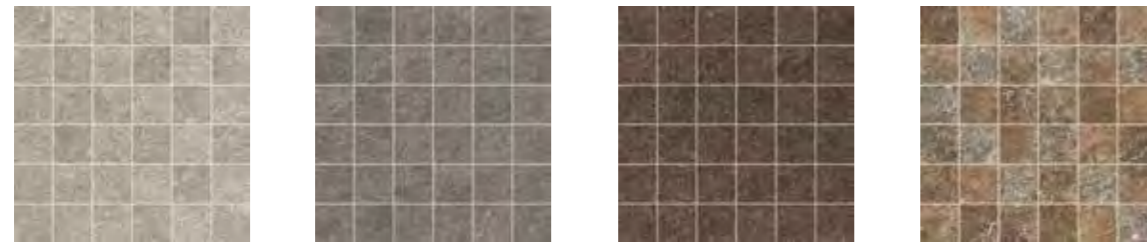

A02H Dolmen Pro
Cenere Mosaico
30x30 - 11³/₄"x11³/₄"

A02I Dolmen Pro
Grigio Mosaico
30x30 - 11³/₄"x11³/₄"

A02K Dolmen Pro
Rosso Mosaico
30x30 - 11³/₄"x11³/₄"

A02L Dolmen Pro
Mix Mosaico
30x30 - 11³/₄"x11³/₄"

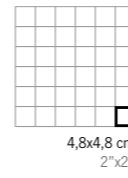
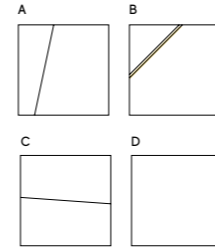

A02M Dolmen Pro
Cenere Brick
37,5x75 - 14³/₄"x29¹/₂"



A02N Dolmen Pro
Grigio Brick
37,5x75 - 14³/₄"x29¹/₂"



A02O Dolmen Pro
Rosso Brick
37,5x75 - 14³/₄"x29¹/₂"



A02Q Dolmen Pro
Mix Brick
37,5x75 - 14³/₄"x29¹/₂"

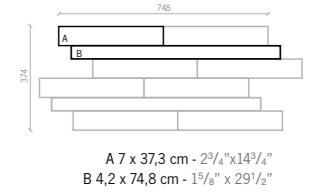

* Metal insert. We recommend use of a neutral detergent. Do not use acid, alkaline or waxing products or metal scouring pads. / Insetto metallico. Si consiglia l'utilizzo di un comune detergente neutro, evitare l'utilizzo di prodotti acidi o alcalini, ceranti e pagliette di metallo. / Inserto metallico. Il est conseillé d'utiliser un produit détergent commun et neutre, d'éviter d'utiliser des produits acides ou alcalins, à base de cire ainsi que les pailles de métal. / Metalleinlage. Ein handelsübliches, neutrales Reinigungsmittel und keine sauren oder alkalischen, wachshaltigen Produkte oder Stahlwolle verwenden. / Inseto metálico. Se recomienda utilizar un detergente neutro y evitar productos ácidos o alcalinos, ceras y estropajos metálicos. / Металлическая вставка. Рекомендуется использовать обычное нейтральное моющее средство, избегать использования кислотных или щелочных продуктов, а также средств для вождения и металлических мочалок.

THE DECORATION CAN ONLY BE LAID ON THE WALL | IL DECORO SI PUÒ POSARE SOLO A RIVESTIMENTO
Décor uniquement mural | Das Dekor kann nur an der Wand verlegt werden | La decoración se puede colocar únicamente en paredes | Декор может быть уложен только на стену.

STONE LOOK

DOLMEN PRO Porcelain Tiles / Gres Porcellanato

DECOR RANGE / GAMMA DECORI

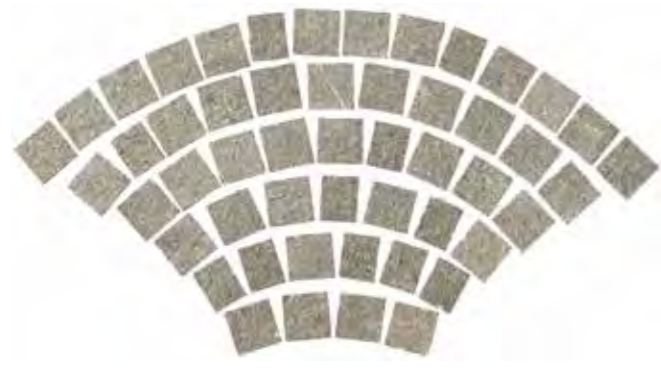

A02R Dolmen Pro Cenere
Coda di Pavone Grip
53,2x102,8 - 20⁷/₈"x40¹/₂"



A02T Dolmen Pro Grigio
Coda di Pavone Grip
53,2x102,8 - 20⁷/₈"x40¹/₂"



A02U Dolmen Pro Rosso
Coda di Pavone Grip
53,2x102,8 - 20⁷/₈"x40¹/₂"

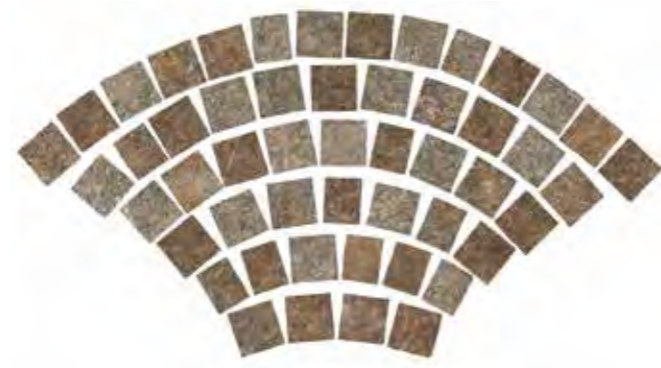

A02V Dolmen Pro Mix
Coda di Pavone Grip
53,2x102,8 - 20⁷/₈"x40¹/₂"



A02W Dolmen Pro Cenere-
Rosso Coda di Pav. Grip
53,2x102,8 - 20⁷/₈"x40¹/₂"

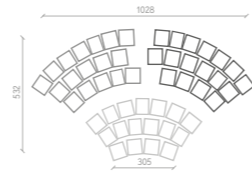

TRIM TILES / PEZZI SPECIALI

p. 568

UPEC p. 595

	Battiscopa 7,2x75 - 2 ⁷ / ₈ "x29 ¹ / ₂ "	Gradino * 37,5x75 - 14 ³ / ₄ "x29 ¹ / ₂ "	Scalino * 37,5x150 - 14 ³ / ₄ "x59"	Scalino * 37,5x75 - 14 ³ / ₄ "x29 ¹ / ₂ "	Scalino Angolare * 37,5x37,5 - 14 ³ / ₄ "x14 ³ / ₄ "	Battiscopa Sag. Scala 7,2x30 - 2 ⁷ / ₈ "x11 ³ / ₄ "		Elemento L Grip * 15x75 H. 4 - 5 ⁷ / ₈ "x29 ¹ / ₂ "	Elemento L Strutturato * 15x30 H. 3,5 - 5 ⁷ / ₈ "x11 ³ / ₄ "
						DX *	SX *		
Cenere	A0U1	A0VE	A0VI	A0VL	A0VP	A0U5	A0U9	A0VT	A04P
Grigio	A0U2	A0VF	A0VJ	A0VM	A0VQ	A0U6	A0VB	A0VU	A04Q
Rosso	A0U3	A0VG	A0VK	A0VN	A0VR	A0U7	A0VC	A0VV	A0TV
Mix	A0U4	A0VH	-	A0VO	A0VS	A0U8	A0VD	A0VW	A0TY

* THESE PARTS ARE SUPPLIED TO ORDER | I PEZZI SONO DISPONIBILI SU ORDINAZIONE | Les pièces sont disponibles sur commande | Die Teile sind auf Bestellung lieferbar | Las piezas se hacen por encargo | Изготавливаются на заказ



STONE LOOK

STONE LOOK



KLIF

PORCELAIN&WALL TILES



Porcelain tiles / Gres porcellanato

COLOURED BODY PORCELAIN TILES - RECTIFIED MONOCALIBER
GRES PORCELLANATO COLORATO IN MASSA - RETTIFICATO MONOCALIBRO

Sizes	Thickness	Surface finish
75x150 cm - 29 1/2" x 59"	± 9 mm	Matte R10 A+B
75x75 cm - 29 1/2" x 29 1/2"	± 9 mm	Matte R10 A+B
37,5x75 cm - 14 3/4" x 29 1/2"	± 9 mm	Matte R10 A+B

Outdoor Paving and Wet Areas

OUTDOOR PAVING p. 554

Sizes	Thickness	Surface finish
37,5x75 cm - 14 3/4" x 29 1/2"	± 9 mm	Grip R11 A+B+C
90x90 cm - 35 3/8" x 35 3/8"	± 20 mm	Textured R11 A+B+C
45x90 cm - 17 3/4" x 35 3/8"	± 20 mm	Textured R11 A+B+C
60x60 cm - 23 5/8" x 23 5/8"	± 20 mm	Textured R11 A+B+C



Wall tiles / Rivestimento

WHITEBODY WALL TILES - RECTIFIED MONOCALIBER
RIVESTIMENTI IN PASTA BIANCA - RETTIFICATO MONOCALIBRO

Sizes	Thickness	Surface finish
40x80 cm - 15 3/4" x 31 1/2"	± 8,5 mm	Matte

3D Wall Tiles

Sizes	Thickness	Surface finish
40x80 cm - 15 3/4" x 31 1/2"	± 10 mm	Matte

KLIF Porcelain Tiles / Gres Porcellanato

MATTE SURFACE / SUPERFICIE MATT



75x150 cm 29 1/2" x 59"
 ANXM Klif White 75x150
 ANXP Klif Silver 75x150
 ANXQ Klif Grey 75x150
 ANXR Klif Dark 75x150

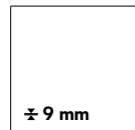

75x75 cm 29 1/2" x 29 1/2"
 ANXS Klif White 75x75
 ANXT Klif Silver 75x75
 ANXU Klif Grey 75x75
 ANXV Klif Dark 75x75



37,5x75 cm 14 3/4" x 29 1/2"
 ANXW Klif White 37,5x75
 ANXX Klif Silver 37,5x75
 ANXY Klif Grey 37,5x75
 ANXZ Klif Dark 37,5x75

MATTE / GRIP



WHITE



SILVER

GRIP SURFACE / SUPERFICIE GRIP



37,5x75 cm 14 3/4" x 29 1/2"
 ANXØ Klif White 37,5x75 Grip
 ANX1 Klif Silver 37,5x75 Grip
 ANX2 Klif Grey 37,5x75 Grip
 ANX3 Klif Dark 37,5x75 Grip

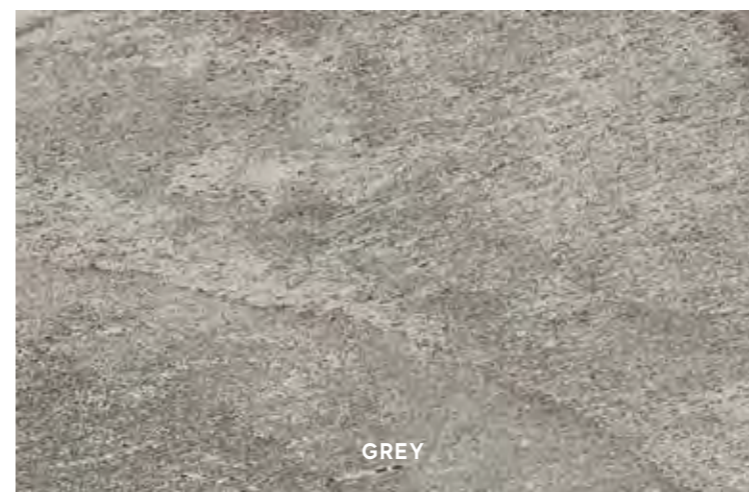

GREY

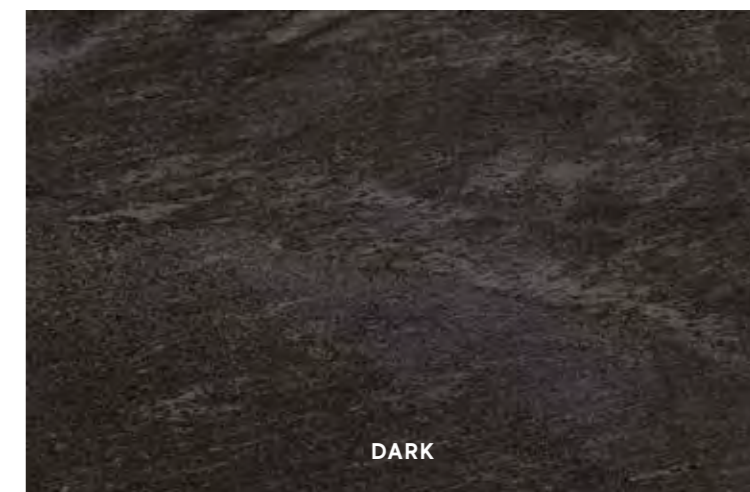

DARK

OUTDOOR PAVING ± 20 mm / PAVIMENTI DA ESTERNO ± 20 mm

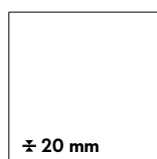

90x90 cm 35 3/8" x 35 3/8"
 AOES Klif Silver 90x90 LASTRA 20 mm
 AOET Klif Grey 90x90 LASTRA 20 mm
 AOEU Klif Dark 90x90 LASTRA 20 mm



45x90 cm 17 3/4" x 35 3/8"
 ANX7 Klif Silver 45x90 LASTRA 20 mm
 ANX8 Klif Grey 45x90 LASTRA 20 mm
 ANX9 Klif Dark 45x90 LASTRA 20 mm

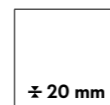

60x60 cm 23 3/8" x 23 3/8"
 ANX4 Klif Silver 60x60 LASTRA 20 mm
 ANX5 Klif Grey 60x60 LASTRA 20 mm
 ANX6 Klif Dark 60x60 LASTRA 20 mm

OUTDOOR PAVING ± 20 mm



SILVER



GREY



DARK



**V3
 MODERATE
 VARIATION**

MATTE SURFACE | SUPERFICIE MATT | Surface Mat | Matt oberfläche | Superficie Mate | Матовая поверхность
GRIP SURFACE | SUPERFICIE GRIP | Surface grip | Grip oberfläche | Superficie Grip | Grip поверхность
OUTDOOR PAVING | PAVIMENTI DA ESTERNO | Sols d'extérieur | Außenbeläge für Außenbereiche | Pavimentos para exteriores | Уличная плитка

STONE LOOK

STONE LOOK

KLIF Porcelain Tiles / Gres Porcellanato

DECOR RANGE / GAMMA DECORI



AN46 Klif White Mosaico
30x30 - 11³/₄"x11³/₄"

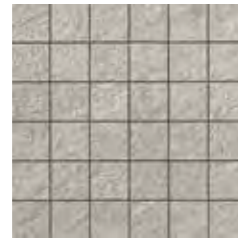

AN47 Klif Silver Mosaico
30x30 - 11³/₄"x11³/₄"

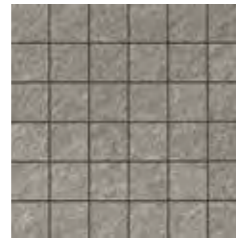

AN48 Klif Grey Mosaico
30x30 - 11³/₄"x11³/₄"



AN49 Klif Dark Mosaico
30x30 - 11³/₄"x11³/₄"

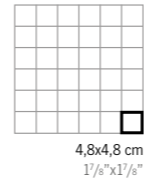

AN7G Klif White Triangles
28,5x33 - 11¹/₄"x13"



AN7H Klif Silver Triangles
28,5x33 - 11¹/₄"x13"



AN7I Klif Grey Triangles
28,5x33 - 11¹/₄"x13"



AN7J Klif Dark Triangles
28,5x33 - 11¹/₄"x13"

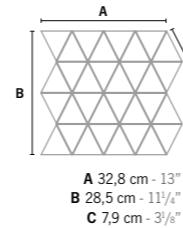

AN7K Klif White Brick 3D
28x55 - 11"x21⁵/₈"



AN7L Klif Silver Brick 3D
28x55 - 11"x21⁵/₈"

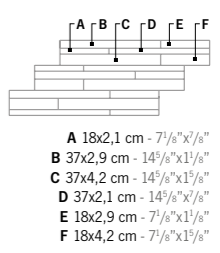

AN7M Klif Grey Brick 3D
28x55 - 11"x21⁵/₈"



AN7N Klif Dark Brick 3D
28x55 - 11"x21⁵/₈"



AN7C Klif White Brick
37,5x75 - 14³/₄"x29¹/₂"



AN7D Klif Silver Brick
37,5x75 - 14³/₄"x29¹/₂"



AN7E Klif Grey Brick
37,5x75 - 14³/₄"x29¹/₂"



AN7F Klif Dark Brick
37,5x75 - 14³/₄"x29¹/₂"

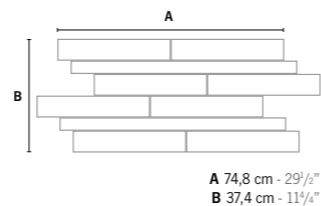

TRIM TILES / PEZZI SPECIALI

p. 568

LUPEC p. 595

	Battiscopa 7,2x75 2 ⁷ / ₈ "x29 ¹ / ₂ "	Gradino * 37,5x75 14 ³ / ₄ "x29 ¹ / ₂ "	Scalino * 37,5x150 14 ³ / ₄ "x59"	Scalino * 37,5x75 14 ³ / ₄ "x29 ¹ / ₂ "	Scalino Angolare * 37,5x37,5 14 ³ / ₄ "x14 ³ / ₄ "	Battiscopa Sag. Scala 7,2x30 - 2 ⁷ / ₈ "x11 ³ / ₄ "		Elemento L Grip 15x75 H.4 cm 5 ⁷ / ₈ "x29 ¹ / ₂ " H.1 ⁵ / ₈ "
						DX *	SX *	
White	AN4F	AN4P	AN4T	AN4X	AN42	AN4H	AN4L	AN5A
Silver	AN2R	AN4Q	AN4U	AN4Y	AN43	AN4I	AN4M	AN5B
Grey	AN2S	AMG4	AN4V	AN4Z	AN44	AN4J	AN4N	AN5C
Dark	AN4G	AN4S	AN4W	AN41	AN45	AN4K	AN4O	AN5D

* THESE PARTS ARE SUPPLIED TO ORDER | I PEZZI SONO DISPONIBILI SU ORDINAZIONE | Les pièces sont disponibles sur commande | Die Teile sind auf Bestellung lieferbar | Las piezas se hacen por encargo | Изготавливаются на заказ

THE DECORATION CAN ONLY BE LAID ON THE WALL | IL DECORO SI PUÒ POSARE SOLO A RIVESTIMENTO
Décor uniquement mural | Das Dekor kann nur an der Wand verlegt werden | La decoración se puede colocar únicamente en paredes | Декор может быть уложен только на стену.

STONE LOOK

STONE LOOK



KLIF
WALL TILES



Wall Tiles / Rivestimento

WHITEBODY WALL TILES - RECTIFIED MONOCALIBER
RIVESTIMENTI IN PASTA BIANCA - RETTIFICATO MONOCALIBRO

Sizes	Thickness	Surface finish
40x80 cm - 15 ³ / ₄ "x31 ¹ / ₂ "	± 8,5 mm	Matte

3D Wall Tiles

Sizes	Thickness	Surface finish
40x80 cm - 15 ³ / ₄ "x31 ¹ / ₂ "	± 10 mm	Matte



WHITEBODY WALL TILES | RIVESTIMENTI IN PASTA BIANCA | Revêtements en pâte blanche | Weißscherbige Wandfliesen | Revestimientos en pasta blanca | Настенная плитка из белой глины
RECTIFIED MONOCALIBER | RETTIFICATO MONOCALIBRO | Rectifié mono-calibre | Geschliffen einkalibrig | Rectificado monocalibré | Ретифицированный в одном калибре

KLIF Wall Tiles / Rivestimento

MATTE SURFACE / SUPERFICIE MATT



8K8W Klif White 40x80
40x80 - 15³/₄"x31¹/₂"



8K8S Klif Silver 40x80
40x80 - 15³/₄"x31¹/₂"



8K8G Klif Grey 40x80
40x80 - 15³/₄"x31¹/₂"



TRIM TILES / PEZZI SPECIALI

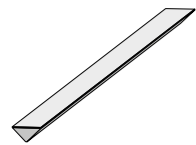

1,4x40 cm - 5⁵/₈"x15³/₄"
LK4W Klif White Corner 40 •
LK4S Klif Silver Corner 40 •
LK4G Klif Grey Corner 40 •



1,4x1,4 cm - 5⁵/₈"x5⁵/₈"
AKCW Klif White Corner A.E. •
AKCL Klif Silver Corner A.E. •
AKCG Klif Grey Corner A.E. •

* THESE PARTS ARE SUPPLIED TO ORDER . I PEZZI SONO DISPONIBILI SU ORDINAZIONE
Les pièces sont disponibles sur commande | Die Teile sind auf Bestellung lieferbar | Las piezas se hacen por encargo | Изготавливаются на заказ
MATTE SURFACE | SUPERFICIE MATT | Surface Mat | Matt oberfläche | Superficie Mate | Матовая поверхность

V2
SLIGHT
VARIATION

KLIF 3D Wall Tiles / Rivestimento 3D

MATTE SURFACE / SUPERFICIE MATT



8KRW Klif 3D Row White 40x80
40x80 - 15³/₄"x31¹/₂"



8KRS Klif 3D Row Silver 40x80
40x80 - 15³/₄"x31¹/₂"



8KRG Klif 3D Row Grey 40x80
40x80 - 15³/₄"x31¹/₂"



TRIM TILES / PEZZI SPECIALI

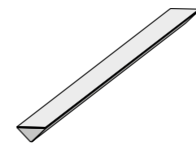

1,4x40 cm - 5⁵/₈"x15³/₄"
LY3W Klif White 3D Corner 40 •
LY3S Klif Silver 3D Corner 40 •
LY3G Klif Grey 3D Corner 40 •



1,4x1,4 cm - 5⁵/₈"x5⁵/₈"
AK3W Klif White Corner A.E. •
AK3S Klif Silver Corner A.E. •
AK3G Klif Grey Corner A.E. •

* THESE PARTS ARE SUPPLIED TO ORDER . I PEZZI SONO DISPONIBILI SU ORDINAZIONE
Les pièces sont disponibles sur commande | Die Teile sind auf Bestellung lieferbar | Las piezas se hacen por encargo | Изготавливаются на заказ
MATTE SURFACE | SUPERFICIE MATT | Surface Mat | Matt oberfläche | Superficie Mate | Матовая поверхность

V2
SLIGHT
VARIATION

STONE LOOK

WALL TILES

399



KONE

PORCELAIN TILES



Porcelain Tiles / Gres Porcellanato

COLOURED BODY PORCELAIN TILES - RECTIFIED MONOCALIBER
GRES PORCELLANATO COLORATO IN MASSA - RETTIFICATO MONOCALIBRO

LARGE SIZES p. 500

Sizes	Thickness	Surface finish
162x324 cm - 63 ³ / ₄ "x127 ¹ / ₂ " NON RECTIFIED - NON RETTIFICATO	± 6-12 mm	Hammered
120x240 cm - 47 ¹ / ₄ "x94 ¹ / ₂ "	± 9 mm	Matte R10 A
120x120 cm - 47 ¹ / ₄ "x47 ¹ / ₄ "	± 9 mm	Matte R10 A
75x150 cm - 29 ¹ / ₂ "x59"	± 9 mm	Matte R10 A
75x75 cm - 29 ¹ / ₂ "x29 ¹ / ₂ "	± 9 mm	Matte R10 A
60x60 cm - 23 ⁵ / ₈ "x23 ⁵ / ₈ "	± 9 mm	Matte R10 A
30x60 cm - 11 ³ / ₄ "x23 ⁵ / ₈ "	± 9 mm	Matte R10 A

Outdoor Paving and Wet Areas

OUTDOOR PAVING p. 554

Sizes	Thickness	Surface finish
30x60 cm - 11 ³ / ₄ "x23 ⁵ / ₈ "	± 9 mm	Grip R11 A+B
60x60 cm - 23 ⁵ / ₈ "x23 ⁵ / ₈ "	± 20 mm	Textured R11 A+B+C



atlas concorde

COLOURED BODY PORCELAIN TILES | GRES PORCELLANATO COLORATO IN MASSA | Grès cérame coloré dans la masse | Durchgefärbtes Feinsteinzeug | Gres porcelánico coloreado en masa | Керамический гранит окрашенный в массе
RECTIFIED MONOCALIBER | RETTIFICATO MONOCALIBRO | Rectifié mono-calibre | Geschliffen einkalibrig | Rettificato monocalibre | Ретифицированный в одном калибре
NON RECTIFIED | NON RETTIFICATO | Non rectifié | Nicht rektifiziert | No rectificada | Неретифицированные

KONE Porcelain Tiles / Gres Porcellanato

MATTE SURFACE / SUPERFICIE MATT

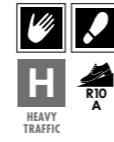

atlasPLAN p. 500



HAMMERED / HAMMERED
162x324 cm 63³/₄"x127¹/₂"
> NON RECTIFIED / NON RETTIFICATO
 AN1T Kone Grey Hammered ± 6 mm ST *
 AN1Q Kone Mix Hammered ± 6 mm ST *
 AMSX Kone Mix Hammered ± 12 mm ST *
 ANXH Kone Grey Hammered ± 12 mm ST *
 AMKD Kone Gypsum Hammered ± 12 mm ST *



120x240 cm 47¹/₄"x94¹/₂"
 AULR Kone White 120x240
 AULS Kone Pearl 120x240
 AULT Kone Grey 120x240

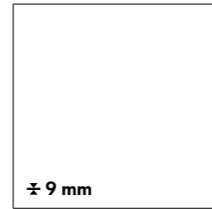

120x120 cm 47¹/₄"x47¹/₄"
 AULO Kone White 120x120
 AULP Kone Pearl 120x120
 AULQ Kone Grey 120x120



75x150 cm 29¹/₂"x59"
 AUKB Kone White 75x150
 AUKC Kone Beige 75x150
 AUKD Kone Silver 75x150
 AUKE Kone Pearl 75x150
 AUKF Kone Grey 75x150
 AAPT Kone Mix 75x150

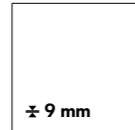

75x75 cm 29¹/₂"x29¹/₂"
 AUKT Kone White 75x75
 AUKU Kone Beige 75x75
 AUKV Kone Silver 75x75
 AUKW Kone Pearl 75x75
 AUKX Kone Grey 75x75

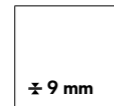

60x60 cm 23⁵/₈"x23⁵/₈"
 AUK8 Kone White 60x60
 AUK9 Kone Beige 60x60
 AULA Kone Silver 60x60
 AULB Kone Pearl 60x60
 AULC Kone Grey 60x60



30x60 cm 11³/₄"x23⁵/₈"
 D216 Kone White 30x60
 D217 Kone Beige 30x60
 D218 Kone Silver 30x60
 D219 Kone Pearl 30x60
 D220 Kone Grey 30x60

GRIP SURFACE / SUPERFICIE GRIP

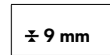

30x60 cm 11³/₄"x23⁵/₈"
 D221 Kone White 30x60 Grip
 D222 Kone Beige 30x60 Grip
 D223 Kone Silver 30x60 Grip
 D224 Kone Pearl 30x60 Grip
 D225 Kone Grey 30x60 Grip

OUTDOOR PAVING ± 20 mm / PAVIMENTI DA ESTERNO ± 20 mm

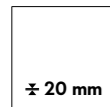

60x60 cm 23⁵/₈"x23⁵/₈"
 AULY Kone Pearl 60x60 LASTRA 20 mm
 AULZ Kone Grey 60x60 LASTRA 20 mm

MATTE / GRIP



WHITE



BEIGE



PEARL



SILVER



GREY

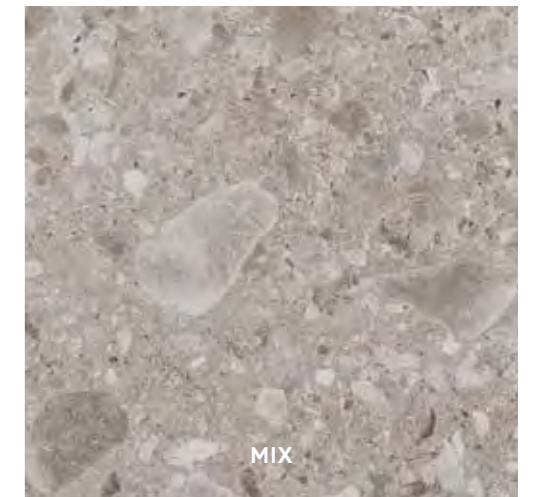

MIX

OUTDOOR PAVING ± 20 mm



PEARL



GREY



**V2
SLIGHT
VARIATION**

MATTE SURFACE | SUPERFICIE MATT | Surface Mat | Matt oberfläche | Superficie Mate | Матовая поверхность
GRIP SURFACE | SUPERFICIE GRIP | Surface grip | Grip oberfläche | Superficie Grip | Grip поверхность
OUTDOOR PAVING | PAVIMENTI DA ESTERNO | Sols d'extérieur | Bodenbeläge für Außenbereiche | Pavimentos para exteriores | Уличная плитка

* WITH FIBERGLASS MESH | VERSIONE STUOIATA | Version à nattes | Ausführung mit Glasfasermatte | Versión con malla | С упрочнением из стекловолоконна
NON RECTIFIED | NON RETTIFICATO | Non rectifié | Nicht rektifiziert | No rectificada | Неретифицированные

STONE LOOK

STONE LOOK

KONE Porcelain Tiles / Gres Porcellanato

DECOR RANGE / GAMMA DECORI

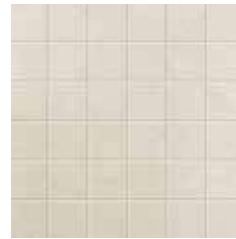

AUNR Kone White Mosaico
30x30 - 11³/₄"x11³/₄"

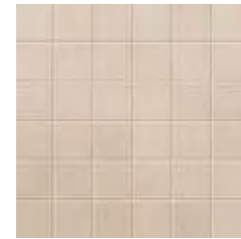

AUNS Kone Beige Mosaico
30x30 - 11³/₄"x11³/₄"



AUNT Kone Silver Mosaico
30x30 - 11³/₄"x11³/₄"



AUNU Kone Pearl Mosaico
30x30 - 11³/₄"x11³/₄"

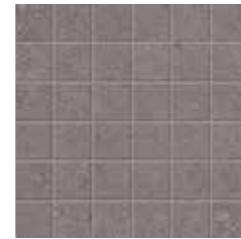

AUNV Kone Grey Mosaico
30x30 - 11³/₄"x11³/₄"



AUN9 Kone White Mosaico Pinnacle 3D
30x30 - 11³/₄"x11³/₄"

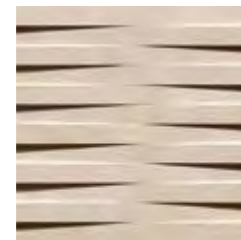

AUAO Kone Beige Mosaico Pinnacle 3D
30x30 - 11³/₄"x11³/₄"



AUOB Kone Silver Mosaico Pinnacle 3D
30x30 - 11³/₄"x11³/₄"

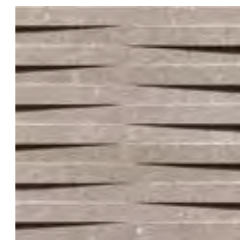

AUOC Kone Pearl Mosaico Pinnacle 3D
30x30 - 11³/₄"x11³/₄"

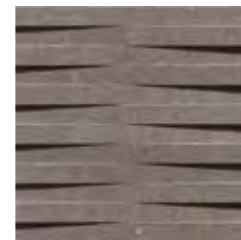

AUOD Kone Grey Mosaico Pinnacle 3D
30x30 - 11³/₄"x11³/₄"



AARA Kone Warm Industrial 3D
31,5x45 - 12³/₈"x17³/₄"

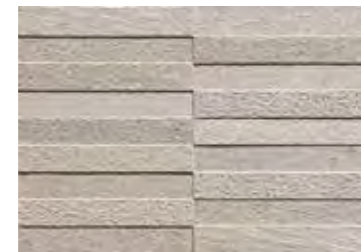

AAQ9 Kone Cold Industrial 3D
31,5x45 - 12³/₈"x17³/₄"



AUOO Kone White Chevron
11,5x67 - 4¹/₂"x26³/₈"



AUOR Kone Pearl Chevron
11,5x67 - 4¹/₂"x26³/₈"

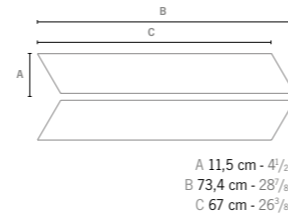

AUOP Kone Beige Chevron
11,5x67 - 4¹/₂"x26³/₈"



AUOS Kone Grey Chevron
11,5x67 - 4¹/₂"x26³/₈"

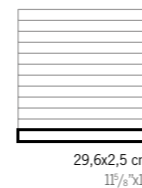

AUOQ Kone Silver Chevron
11,5x67 - 4¹/₂"x26³/₈"

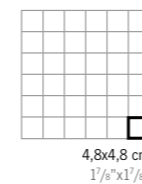

AUNW Kone White Brick
30x60 - 11³/₄"x23⁵/₈"



AUNZ Kone Pearl Brick
30x60 - 11³/₄"x23⁵/₈"



AUNX Kone Beige Brick
30x60 - 11³/₄"x23⁵/₈"



AUNØ Kone Grey Brick
30x60 - 11³/₄"x23⁵/₈"



AUNY Kone Silver Brick
30x60 - 11³/₄"x23⁵/₈"

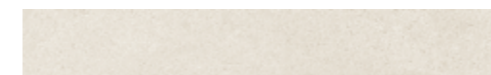
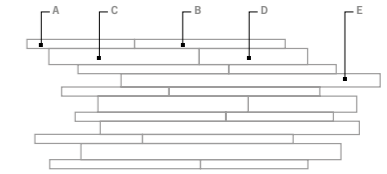

AUNM Kone White Listello
8x60 - 3¹/₈"x23⁵/₈"

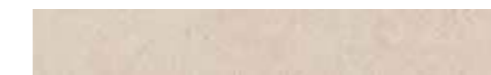

AUNN Kone Beige Listello
8x60 - 3¹/₈"x23⁵/₈"



AUNO Kone Silver Listello
8x60 - 3¹/₈"x23⁵/₈"



AUNP Kone Pearl Listello
8x60 - 3¹/₈"x23⁵/₈"



AUNQ Kone Grey Listello
8x60 - 3¹/₈"x23⁵/₈"

TRIM TILES / PEZZI SPECIALI

p. 568

UPEC p. 595

	Battiscopa 7,2x60 2 ⁷ / ₈ "x23 ⁵ / ₈ "	Gradino * 30x60 11 ³ / ₄ "x23 ⁵ / ₈ "	Scalino * 33x150 13"x59"	Scalino * 33x75 13"x29 ¹ / ₂ "	Scalino * 33x60 13"x23 ⁵ / ₈ "	Scalino Angolare * 33x33 13"x13"	Battiscopa Sag. Scala 7,2x30 - 2 ⁷ / ₈ "x11 ³ / ₄ "		Elemento L Grip * 15x60 H. 4 5 ⁷ / ₈ "x23 ⁵ / ₈ " H. 1 ⁵ / ₈ "
							DX *	SX *	
White	AUOT	AUP6	A8N7	AALF	AAK3	AALK	AUO3	AUOY	AAQ4
Beige	AUOU	AUP7	A8N8	AALG	AAK4	AALL	AUO4	AUOZ	AAQ5
Silver	AUOV	AUP8	A8N9	AALH	AAK5	AALM	AUO5	AUOØ	AAQ6
Pearl	AUOW	AUP9	A8OA	AALI	AAK6	AALN	AUO6	AUO1	AAQ7
Grey	AUOX	AUQA	A8OB	AALJ	AAK7	AALO	AUO7	AUO2	AAQ8

* THESE PARTS ARE SUPPLIED TO ORDER | I PEZZI SONO DISPONIBILI SU ORDINAZIONE | Les pièces sont disponibles sur commande | Die Teile sind auf Bestellung lieferbar | Las piezas se hacen por encargo | Изготавливаются на заказ

THE DECORATION CAN ONLY BE LAID ON THE WALL | IL DECORO SI PUÒ POSARE SOLO A RIVESTIMENTO
Décor uniquement mural | Das Dekor kann nur an der Wand verlegt werden | La decoración se puede colocar únicamente en paredes | Декор может быть уложен только на стену.



LIMS
PORCELAIN & WALL TILES

Porcelain Tiles / Gres Porcellanato

COLOURED BODY PORCELAIN TILES - RECTIFIED MONOCALIBER
GRES PORCELLANATO COLORATO IN MASSA - RETTIFICATO MONOCALIBRO

LARGE SIZES p. 500

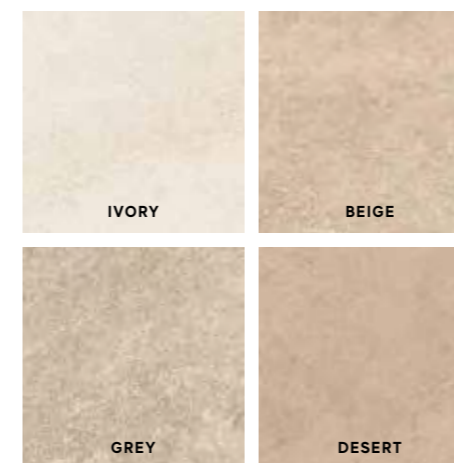

Sizes	Thickness	Surface finish
120x278 cm - 47 ¹ / ₄ "x109 ¹ / ₂ "	± 6 mm	Matte R9 A
120x120 cm - 47 ¹ / ₄ "x47 ¹ / ₄ "	± 9 mm	Matte R10 A+B
75x150 cm - 29 ¹ / ₂ "x59"	± 9 mm	Matte R10 A+B
75x75 cm - 29 ¹ / ₂ "x29 ¹ / ₂ "	± 9 mm	Matte R10 A+B
37,5x75 cm - 14 ³ / ₄ "x29 ¹ / ₂ "	± 9 mm	Matte Bush Hammered Line Tumbled R10 A+B

Outdoor Paving and Wet Areas

OUTDOOR PAVING p. 554

Sizes	Thickness	Surface finish
37,5x75 cm - 14 ³ / ₄ "x29 ¹ / ₂ "	± 9 mm	Grip R11 A+B+C
60x120 cm - 23 ⁵ / ₈ "x47 ¹ / ₄ "	± 20 mm	Textured R11 A+B+C
60x60 cm - 23 ⁵ / ₈ "x23 ⁵ / ₈ "	± 20 mm	Textured R11 A+B+C

Wall Tiles / Rivestimento

WHITEBODY WALL TILES - RECTIFIED MONOCALIBER
RIVESTIMENTI IN PASTA BIANCA - RETTIFICATO MONOCALIBRO



Sizes	Thickness	Surface finish
40x80 cm - 15 ³ / ₄ "x31 ¹ / ₂ "	± 8,5 mm	Matte

3D Wall Tiles

Sizes	Thickness	Surface finish
40x80 cm - 15 ³ / ₄ "x31 ¹ / ₂ "	± 10 mm	Matte

LIMS Porcelain Tiles / Gres Porcellanato

MATTE SURFACE / SUPERFICIE MATT

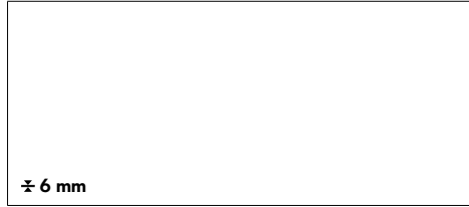

120x278 cm 47¹/₄"x109¹/₂"

A3EI Lims Ivory 120x278
A3EJ Lims Beige 120x278
A3EK Lims Grey 120x278
A3EL Lims Desert 120x278

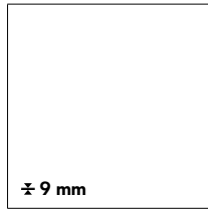

120x120 cm 47¹/₄"x47¹/₄"

A3DI Lims Ivory 120x120
A3DJ Lims Beige 120x120
A3DK Lims Grey 120x120
A3DL Lims Desert 120x120



75x150 cm 29¹/₂"x59"

A3DM Lims Ivory 75x150
A3DN Lims Beige 75x150
A3DO Lims Grey 75x150
A3DP Lims Desert 75x150

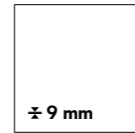

75x75 cm 29¹/₂"x29¹/₂"

A3DQ Lims Ivory 75x75
A3DR Lims Beige 75x75
A3DS Lims Grey 75x75
A3DT Lims Desert 75x75

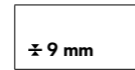

37,5x75 cm 14³/₄"x29¹/₂"

A3DU Lims Ivory 37,5x75
A3DV Lims Beige 37,5x75
A3DW Lims Grey 37,5x75
A3DX Lims Desert 37,5x75



BUSH HAMMERED SURFACE / SUPERFICIE BUSH HAMMERED

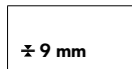

37,5x75 cm 14³/₄"x29¹/₂"

A3EA Lims Ivory 37,5x75 Bush Hammered
A3EB Lims Beige 37,5x75 Bush Hammered
A3EC Lims Grey 37,5x75 Bush Hammered
A3ED Lims Desert 37,5x75 Bush Hammered



LINE SURFACE / SUPERFICIE LINE

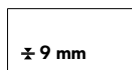

37,5x75 cm 14³/₄"x29¹/₂"

A3EE Lims Ivory 37,5x75 Line
A3EF Lims Beige 37,5x75 Line
A3EG Lims Grey 37,5x75 Line
A3EH Lims Desert 37,5x75 Line



TUMBLED SURFACE / SUPERFICIE TUMBLED

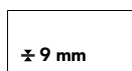

37,5x75 cm 14³/₄"x29¹/₂"

A3FT Lims Ivory 37,5x75 Tumbled
A3FU Lims Beige 37,5x75 Tumbled
A3FV Lims Grey 37,5x75 Tumbled
A3FW Lims Desert 37,5x75 Tumbled



MATTE SURFACE | SUPERFICIE MATT | Surface Mat | Matt oberfläche | Superficie Mate | Матовая поверхность
BUSH HAMMERED SURFACE | SUPERFICIE BUSH HAMMERED | Surface Bush Hammered | Surface Bush hammered | Gehämmerte Oberfläche | Superficie abujardada | Бучардированная поверхность
LINE SURFACE | SUPERFICIE LINE | Surface Line | Linienerfläche | Superficie Line | Поверхность Line
TUMBLED SURFACE | SUPERFICIE TUMBLED | Surface Tumbled | Getrommelte Oberfläche | Superficie Tumbled | Галтованная поверхность

MATTE



IVORY



BEIGE

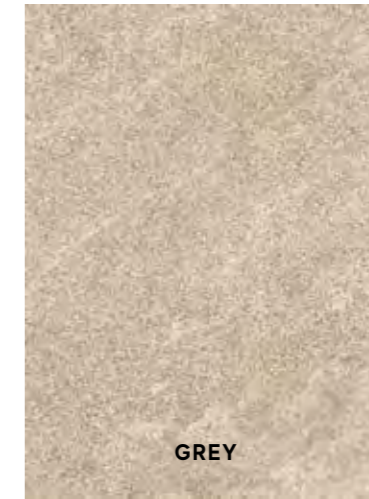

GREY



DESERT

BUSH HAMMERED



IVORY

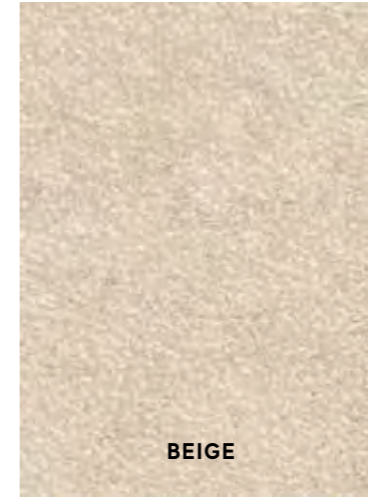

BEIGE

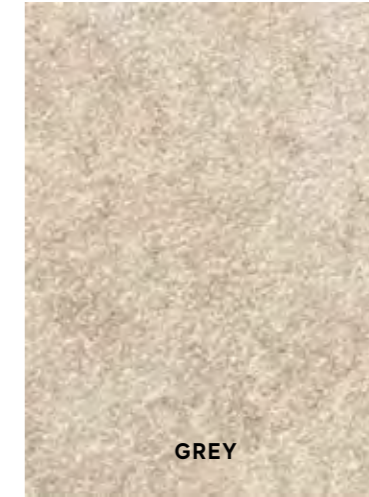

GREY

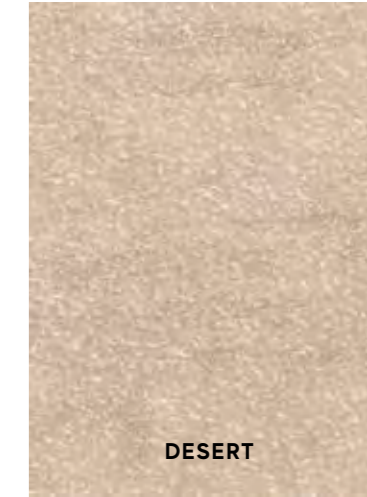

DESERT

LINE



IVORY



BEIGE



GREY

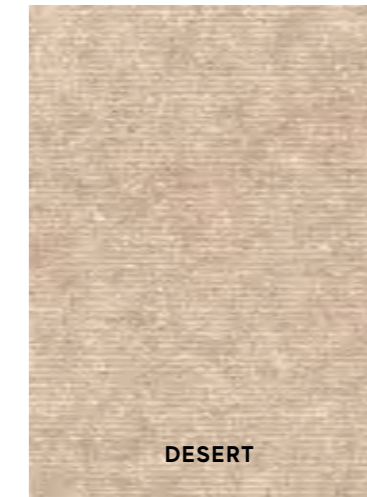

DESERT

TUMBLED



IVORY



BEIGE



GREY



DESERT

STONE LOOK

STONE LOOK

LIMS Porcelain Tiles / Gres Porcellanato

GRIP SURFACE / SUPERFICIE GRIP



± 9 mm

37,5x75 cm 14⁹/₁₆"x29¹/₂"

- A3DY Lims Ivory 37,5x75 Grip
- A3DZ Lims Beige 37,5x75 Grip
- A3DØ Lims Grey 37,5x75 Grip
- A3D1 Lims Desert 37,5x75 Grip

GRIP



IVORY



BEIGE



GREY



DESERT

OUTDOOR PAVING ± 20 mm / PAVIMENTI DA ESTERNO ± 20 mm



± 20 mm

60x120 cm 23⁵/₈"x47¹/₄"

- A3LU Lims Ivory 60x120 20 mm
- A3LV Lims Beige 60x120 20 mm
- A3LW Lims Grey 60x120 20 mm
- A3LX Lims Desert 60x120 20 mm

± 20 mm

60x60 cm 23⁵/₈"x23⁵/₈"

- A3LY Lims Ivory 60x60 20 mm
- A3LZ Lims Beige 60x60 20 mm
- A3LØ Lims Grey 60x60 20 mm
- A3L1 Lims Desert 60x60 20 mm

OUTDOOR PAVING ± 20 mm



IVORY



BEIGE



GREY



DESERT



V3
MODERATE
VARIATION

LIMS Porcelain Tiles / Gres Porcellanato

DECOR RANGE / GAMMA DECORI



A3JA Lims Ivory Brick
37,5x75 - 14³/₄"x29¹/₂"



A3JB Lims Beige Brick
37,5x75 - 14³/₄"x29¹/₂"



A3JC Lims Grey Brick
37,5x75 - 14³/₄"x29¹/₂"



A3JD Lims Desert Brick
37,5x75 - 14³/₄"x29¹/₂"

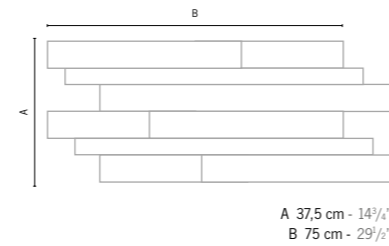

A3JE Lims Ivory Mosaico Gemini
41,6x24 - 12¹/₄"x9¹/₂"



A3JF Lims Beige Mosaico Gemini
41,6x24 - 12¹/₄"x9¹/₂"



A3JG Lims Grey Mosaico Gemini
41,6x24 - 12¹/₄"x9¹/₂"



A3JH Lims Desert Mosaico Gemini
41,6x24 - 12¹/₄"x9¹/₂"

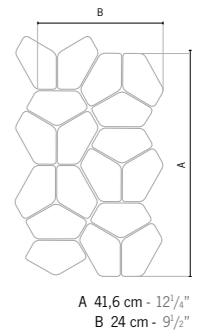

A3NE Lims Ivory Mosaico Spritz
29x32,3 - 11³/₈"x12³/₄"



A3NF Lims Beige Mosaico Spritz
29x32,3 - 11³/₈"x12³/₄"



A3NG Lims Grey Mosaico Spritz
29x32,3 - 11³/₈"x12³/₄"



A3NH Lims Desert Mosaico Spritz
29x32,3 - 11³/₈"x12³/₄"

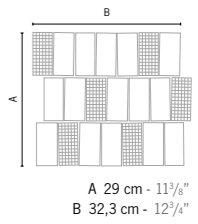

A3HK Lims Ivory Mosaico Tumbled •
30x30 - 11³/₄"x11³/₄"



A3HL Lims Beige Mosaico Tumbled •
30x30 - 11³/₄"x11³/₄"



A3HM Lims Grey Mosaico Tumbled •
30x30 - 11³/₄"x11³/₄"



A3HN Lims Desert Mosaico Tumbled •
30x30 - 11³/₄"x11³/₄"

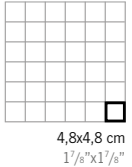

TRIM TILES / PEZZI SPECIALI

p. 568

UPEC p. 595

	Battiscopa 7,2x75 - 2 ⁷ / ₈ "x29 ¹ / ₂ "	Gradino • 37,5x75 - 14 ³ / ₄ "x29 ¹ / ₂ "	Scalino • 37,5x150 - 14 ³ / ₄ "x59"	Scalino • 33x120 - 13"x47 ¹ / ₄ "	Scalino • 37,5x75 - 14 ³ / ₄ "x29 ¹ / ₂ "	Scalino Angolare • 37,5x37,5 - 14 ³ / ₄ "x14 ³ / ₄ "	Scalino Angolare • 33x33 - 13"x13"	Corner ≠ 6 mm • 1x120 - 2 ⁷ / ₈ "x47 ¹ / ₄ "	Corner A.E. ≠ 6 mm • 1x1 - 2 ⁷ / ₈ "x2 ⁷ / ₈ "	Battiscopa Sag. Scala 7,2x30 - 2 ⁷ / ₈ "x11 ³ / ₄ "	Elemento L Grip • 15x75 H. 4 - 5 ⁷ / ₈ "x29 ¹ / ₂ "	
										DX •	SX •	
Ivory	A3MK	A3VV	A3NU	A3NQ	A3VZ	A3WD	A3NY	A3WH	A3WL	A3JQ	A3JM	A3N2
Beige	A3ML	A3VW	A3NV	A3NR	A3WA	A3WE	A3NZ	A3WI	A3WM	A3JR	A3JN	A3N3
Grey	A3VT	A3VX	A3NW	A3NS	A3WB	A3WF	A3NØ	A3WJ	A3WN	A3JS	A3JO	A3N4
Desert	A3VU	A3VY	A3NX	A3NT	A3WC	A3WG	A3N1	A3WK	A3WO	A3JT	A3JP	A3N5

* THESE PARTS ARE SUPPLIED TO ORDER . I PEZZI SONO DISPONIBILI SU ORDINAZIONE | Les pièces sont disponibles sur commande | Die Teile sind auf Bestellung lieferbar | Las piezas se hacen por encargo | Изготавливаются на заказ

• Tumbled / Burattato / Tamisé / Genarbt / Tamboreado / Выщербленный



Wall Tiles / Rivestimento

WHITEBODY WALL TILES - RECTIFIED MONOCALIBER
RIVESTIMENTI IN PASTA BIANCA - RETTIFICATO MONOCALIBRO

Sizes	Thickness	Surface finish
40x80 cm - 15 ³ / ₄ "x31 ¹ / ₂ "	± 8,5 mm	Matte

3D Wall Tiles

Sizes	Thickness	Surface finish
40x80 cm - 15 ³ / ₄ "x31 ¹ / ₂ "	± 10 mm	Matte



WHITEBODY WALL TILES | RIVESTIMENTI IN PASTA BIANCA | Revêtements en pâte blanche | Weißscherbige Wandfliesen | Revestimientos en pasta blanca | Настенная плитка из белой глины
RECTIFIED MONOCALIBER | RETTIFICATO MONOCALIBRO | Rectifié mono-calibre | Geschliffen einkalbrig | Rectificado monocalibré | Ретифицированный в одном калибре

LIMS Wall Tiles / Rivestimento

MATTE SURFACE / SUPERFICIE MATT



A3H0 Lims Ivory 40x80
40x80 - 15³/₄"x31¹/₂"



A3HP Lims Beige 40x80
40x80 - 15³/₄"x31¹/₂"

TRIM TILES / PEZZI SPECIALI



1,4x40 cm - 5⁵/₈"x15³/₄"
A3HV Lims Ivory Corner 40 •
A3HW Lims Beige Corner 40 •



1,4x1,4 cm - 5⁵/₈"x5⁵/₈"
A3HZ Lims Ivory Corner A.E. •
A3H0 Lims Beige Corner A.E. •

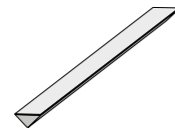

1,4x40 cm - 5⁵/₈"x15³/₄"
A3HX Lims 3D Wallpaper Ivory Corner 40 •
A3HY Lims 3D Wallpaper Beige Corner 40 •



atlas concorde



LIMS 3D Wall Tiles / Rivestimento 3D

MATTE SURFACE / SUPERFICIE MATT



A3HR Lims 3D Wallpaper Ivory 40x80
40x80 - 15³/₄"x31¹/₂"



A3HS Lims 3D Wallpaper Beige 40x80
40x80 - 15³/₄"x31¹/₂"



A3HT Lims 3D Way Ivory 40x80
40x80 - 15³/₄"x31¹/₂"



A3HU Lims 3D Way Beige 40x80
40x80 - 15³/₄"x31¹/₂"



atlas concorde



V2
SLIGHT
VARIATION

MATTE SURFACE | SUPERFICIE MATT | Surface Mat | Matt oberfläche | Superficie Mate | Матовая поверхность



V2
SLIGHT
VARIATION

417



MARVEL

STONE

PORCELAIN TILES



Porcelain Tiles / Gres Porcellanato

COLOURED BODY PORCELAIN TILES - RECTIFIED MONOCALIBER
GRES PORCELLANATO COLORATO IN MASSA - RETTIFICATO MONOCALIBRO

LARGE SIZES p. 500

Sizes	Thickness	Surface finish
162x324 cm - 63 ³ / ₄ "x127 ¹ / ₂ " NON RECTIFIED - NON RETTIFICATO	± 6-12-20 mm	Hammered
120x240 cm - 47 ¹ / ₄ "x94 ¹ / ₂ "	± 9 mm	Matte R9 A
120x120 cm - 47 ¹ / ₄ "x47 ¹ / ₄ "	± 9 mm	Matte R9 A
75x150 cm - 29 ¹ / ₂ "x59"	± 9 mm	Matte R9 A
75x75 cm - 29 ¹ / ₂ "x29 ¹ / ₂ "	± 9 mm	Matte R9 A
45x90 cm - 17 ³ / ₄ "x35 ³ / ₈ "	± 9 mm	Matte R9 A
60x60 cm - 23 ⁵ / ₈ "x23 ⁵ / ₈ "	± 9 mm	Matte R9 A
30x60 cm - 11 ³ / ₄ "x23 ⁵ / ₈ "	± 9 mm	Matte R9 A

Outdoor Paving and Wet Areas

OUTDOOR PAVING p. 554

Sizes	Thickness	Surface finish
30x60 cm - 11 ³ / ₄ "x23 ⁵ / ₈ "	± 9 mm	Textured R11 A+B+C
60x120 cm - 23 ⁵ / ₈ "x47 ¹ / ₄ "	± 20 mm	Textured R11 A+B+C

MARVEL STONE COLLECTION
MARBLE LOOK p. 342



COLOURED BODY PORCELAIN TILES | GRES PORCELLANATO COLORATO IN MASSA | Grès céramé coloré dans la masse | Durchgefärbtes Feinsteinzeug | Gres porcelánico coloreado en masa | Керамический гранит окрашенный в массе
RECTIFIED MONOCALIBER | RETTIFICATO MONOCALIBRO | Rectifié mono-calibre | Geschliffen einkalibrig | Rettificato monocalibre | Ретифицированный в одном калибре
NON RECTIFIED | NON RETTIFICATO | Non rectifié | Nicht rektifiziert | No rectificada | Неретифицированные

MARVEL STONE Porcelain Tiles / Gres Porcellanato

MATTE SURFACE / SUPERFICIE MATT

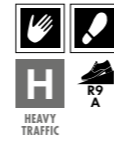

atlasPLAN p. 500

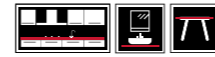

HAMMERED / HAMMERED
162x324 cm 63^{3/4}"x127^{1/2}"
 > **NON RECTIFIED / NON RETTIFICATO**
 AL9Z Basaltina Volcano Hammered ± 6 mm ST *
 ANVI Basaltina Volcano Hammered ± 12 mm ST *
 AZXS Basaltina Volcano Hammered ± 20 mm



120x240 cm 47^{1/4}"x94^{1/2}"
 AZT2 Marvel Clauzetto White 120x240
 AZT1 Marvel Cardoso Elegant 120x240
 AZT0 Marvel Basaltina Volcano 120x240

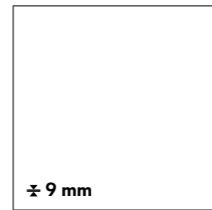

120x120 cm 47^{1/4}"x47^{1/4}"
 AZT5 Marvel Clauzetto White 120x120
 AZT4 Marvel Cardoso Elegant 120x120
 AZT3 Marvel Basaltina Volcano 120x120



75x150 cm 29^{1/2}"x59"
 AZNQ Marvel Clauzetto White 75x150
 AZNP Marvel Desert Beige 75x150
 AZNO Marvel Cardoso Elegant 75x150
 AZNN Marvel Basaltina Volcano 75x150

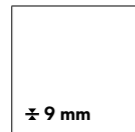

75x75 cm 29^{1/2}"x29^{1/2}"
 AZNV Marvel Clauzetto White 75x75
 AZNU Marvel Desert Beige 75x75
 AZNT Marvel Cardoso Elegant 75x75
 AZNS Marvel Basaltina Volcano 75x75

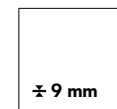

60x60 cm 23^{3/8}"x23^{3/8}"
 AZQ9 Marvel Clauzetto White 60x60
 AZQ8 Marvel Desert Beige 60x60
 AZQ7 Marvel Cardoso Elegant 60x60
 AZQ6 Marvel Basaltina Volcano 60x60

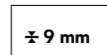

30x60 cm 11^{3/4}"x23^{3/8}"
 D118 Marvel Clauzetto White 30x60
 D117 Marvel Desert Beige 30x60
 D116 Marvel Cardoso Elegant 30x60
 D115 Marvel Basaltina Volcano 30x60

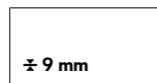

45x90 cm 17^{3/4}"x35^{3/8}"
 AZQ5 Marvel Clauzetto White 45x90
 AZQ4 Marvel Desert Beige 45x90
 AZQ3 Marvel Cardoso Elegant 45x90
 AZQ2 Marvel Basaltina Volcano 45x90

TEXTURED SURFACE / SUPERFICIE STRUTTURATA

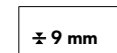

30x60 cm 11^{3/4}"x23^{3/8}"
 D123 Marvel Clauzetto White 30x60 Textured
 D122 Marvel Desert Beige 30x60 Textured
 D121 Marvel Cardoso Elegant 30x60 Textured
 D119 Marvel Basaltina Volcano 30x60 Textured

OUTDOOR PAVING ± 20 mm / PAVIMENTI DA ESTERNO ± 20 mm



60x120 cm 23^{3/8}"x47^{1/4}"
 AZQK Marvel Cardoso Elegant 60x120 LASTRA 20 mm
 AZQJ Marvel Basaltina Volcano 60x120 LASTRA 20 mm



V2 SLIGHT VARIATION

MATTE SURFACE | SUPERFICIE MATT | Surface Mat | Matt oberfläche | Superficie Mate | Матовая поверхность
TEXTURED SURFACE | SUPERFICIE STRUTTURATA | Surface structurée | Strukturiert oberfläche | Superficie estructurado | Структурная поверхность
OUTDOOR PAVING | PAVIMENTI DA ESTERNO | Sols d'extérieur | Außenbeläge für Außenbereiche | Pavimentos para exteriores | Уличная плитка
 * WITH FIBERGLASS MESH | VERSIONE STUOIATA | Version à nattes | Ausführung mit Glasfasermatte | Versión con malla | С упрочнением из стекловолоконка
NON RECTIFIED | NON RETTIFICATO | Non rectifié | Nicht rektifiziert | No rectificada | Неретифицированные

MATTE / TEXTURED



CLAUZETTO WHITE

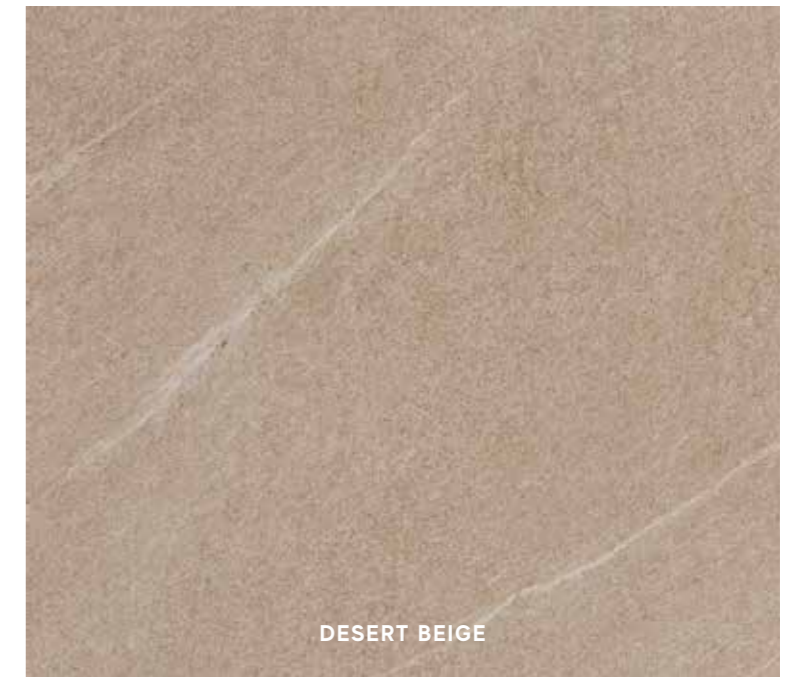

DESERT BEIGE

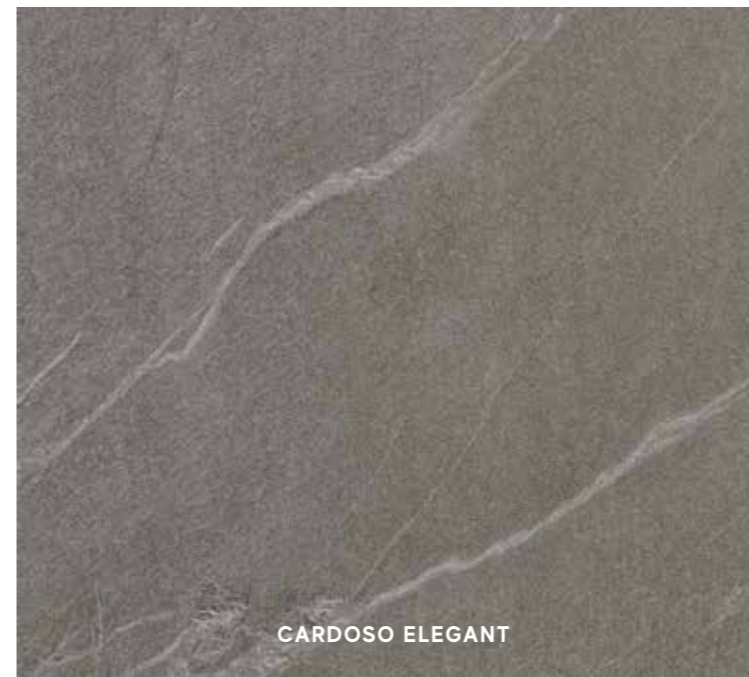

CARDOSO ELEGANT

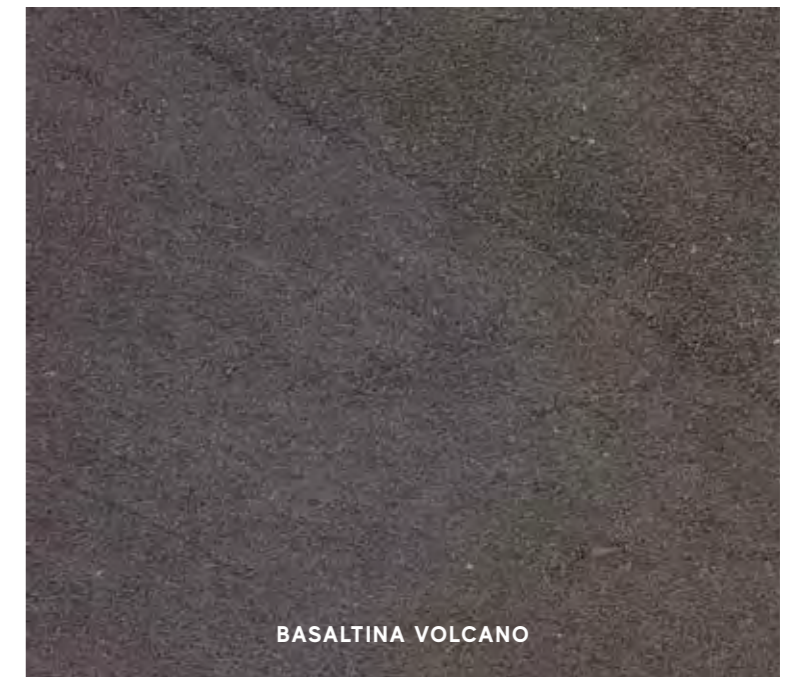

BASALTINA VOLCANO

OUTDOOR PAVING ± 20 mm



CARDOSO ELEGANT



BASALTINA VOLCANO

STONE LOOK

STONE LOOK

MARVEL STONE Porcelain Tiles / Gres Porcellanato

DECOR RANGE / GAMMA DECORI

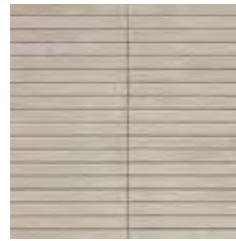

AS4J Marvel Clauzetto White Mosaico Bacchetta
30x30 - 11³/₄"x11³/₄"



AS4I Marvel Desert Beige Mosaico Bacchetta
30x30 - 11³/₄"x11³/₄"



AS4H Marvel Cardoso Elegant Mosaico Bacchetta
30x30 - 11³/₄"x11³/₄"



AS4G Marvel Basaltina Volcano Mosaico Bacchetta
30x30 - 11³/₄"x11³/₄"

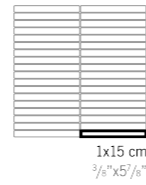

AS4N Marvel Clauzetto White Mosaico Burattato
29,8x29,8 - 11⁵/₈"x11⁵/₈"



AS4M Marvel Desert Beige Mosaico Burattato
29,8x29,8 - 11⁵/₈"x11⁵/₈"



AS4L Marvel Cardoso Elegant Mosaico Burattato
29,8x29,8 - 11⁵/₈"x11⁵/₈"



AS4K Marvel Basaltina Volcano Mosaico Burattato
29,8x29,8 - 11⁵/₈"x11⁵/₈"

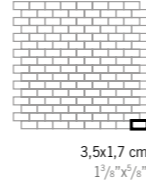

AS4F Marvel Clauzetto White Mosaico
30x30 - 11³/₄"x11³/₄"



AS4E Marvel Desert Beige Mosaico
30x30 - 11³/₄"x11³/₄"



AS4D Marvel Cardoso Elegant Mosaico
30x30 - 11³/₄"x11³/₄"



AS4C Marvel Basaltina Volcano Mosaico
30x30 - 11³/₄"x11³/₄"

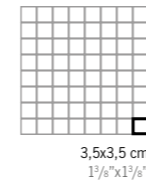

AS4S Marvel Clauzetto White Brick
30x60 - 11³/₄"x23⁵/₈"

AS4Q Marvel Desert Beige Brick
30x60 - 11³/₄"x23⁵/₈"

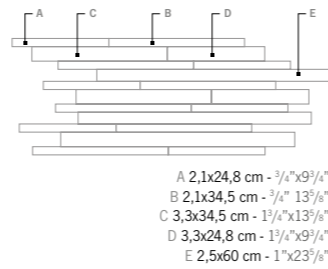

AS4P Marvel Cardoso Elegant Brick
30x60 - 11³/₄"x23⁵/₈"

AS4O Marvel Basaltina Volcano Brick
30x60 - 11³/₄"x23⁵/₈"



AS5A Marvel Clauzetto White Brick 3D
30x59 - 11³/₄"x23⁵/₈"



AS49 Marvel Desert Beige Brick 3D
30x59 - 11³/₄"x23⁵/₈"

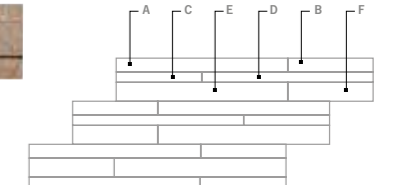

AS48 Marvel Cardoso Elegant Brick 3D
30x59 - 11³/₄"x23⁵/₈"



AS47 Marvel Basaltina Volcano Brick 3D
30x59 - 11³/₄"x23⁵/₈"



AS46 Marvel Clauzetto White Listello
7x60 - 2³/₄"x23⁵/₈"



AS45 Marvel Desert Beige Listello
7x60 - 2³/₄"x23⁵/₈"



AS44 Marvel Cardoso Elegant Listello
7x60 - 2³/₄"x23⁵/₈"



AS43 Marvel Basaltina Volcano Listello
7x60 - 2³/₄"x23⁵/₈"

TRIM TILES / PEZZI SPECIALI

p. 568

UPECC p. 595

		Battiscopa 7,2x60 2 ⁷ / ₈ "x23 ⁵ / ₈ "	Battiscopa Digitale 4,6x60 1 ³ / ₄ "x23 ⁵ / ₈ "	Gradino * 30x60 11 ³ / ₄ "x23 ⁵ / ₈ "	Scalino 150 * 33x150 13"x59"	Scalino 60 * 33x60 13"x23 ⁵ / ₈ "	Scalino Angolare 33x33 - 13"x13"	Battiscopa Sag. Scala 7,2x30 - 2 ⁷ / ₈ "x11 ³ / ₄ "	Elemento L Strutturato * 15x60 H. 4 5 ⁷ / ₈ "x23 ⁵ / ₈ " H. 1 ⁵ / ₈ "		
		DX *	SX *	DX *	SX *	DX *	SX *	DX *	SX *		
	Clauzetto White	ATFG	ATFC	ATFK	ATF6	ATGU	ATG2	ATGY	ATHR	ATHV	ATHZ
	Desert Beige	ATFF	ATFB	ATFJ	ATF5	ATF9	ATG1	ATGX	ATHQ	ATHU	ATHY
	Cardoso Elegant	ATFE	ATFA	ATFI	ATF4	ATF8	ATG0	ATGW	ATHP	ATHT	ATHX
	Basaltina Volcano	ATFD	ATE9	ATFH	ATFL	ATF7	ATGZ	ATGV	ATHO	ATHS	ATHW

* THESE PARTS ARE SUPPLIED TO ORDER | I PEZZI SONO DISPONIBILI SU ORDINAZIONE | Les pièces sont disponibles sur commande | Die Teile sind auf Bestellung lieferbar | Las piezas se hacen por encargo | Изготавливаются на заказ

THE DECORATION CAN ONLY BE LAID ON THE WALL | IL DECORO SI PUÒ POSARE SOLO A RIVESTIMENTO
Décor uniquement mural | Das Dekor kann nur an der Wand verlegt werden | La decoración se puede colocar únicamente en paredes | Декор может быть уложен только на стену.



NORDE

PORCELAIN TILES

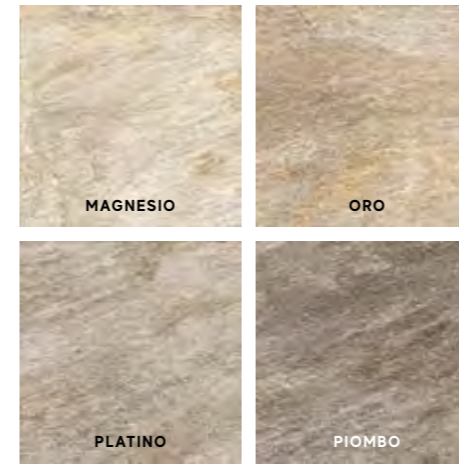

Porcelain Tiles / Gres Porcellanato

COLOURED BODY PORCELAIN TILES - RECTIFIED MONOCALIBER
GRES PORCELLANATO COLORATO IN MASSA - RETTIFICATO MONOCALIBRO

Sizes	Thickness	Surface finish
60x120 cm - 23 ⁵ / ₈ "x47 ¹ / ₄ "	± 9 mm	Matte R10 A+B
60x60 cm - 23 ⁵ / ₈ "x23 ⁵ / ₈ "	± 9 mm	Matte R10 A+B
30x60 cm - 11 ³ / ₄ "x23 ⁵ / ₈ "	± 9 mm	Matte R10 A+B

Outdoor Paving and Wet Areas

OUTDOOR PAVING p. 554

Sizes	Thickness	Surface finish
30x60 cm - 11 ³ / ₄ "x23 ⁵ / ₈ "	± 9 mm	Roccia R12 A+B+C
60x120 cm - 23 ⁵ / ₈ "x47 ¹ / ₄ "	± 9 mm	Grip R11 A+B+C
60x120 cm - 23 ⁵ / ₈ "x47 ¹ / ₄ "	± 20 mm	Textured R11 A+B+C
60x90 cm - 23 ⁵ / ₈ "x35 ³ / ₈ "	± 20 mm	Textured R11 A+B+C
80x80 cm - 31 ¹ / ₂ "x31 ¹ / ₂ "	± 20 mm	Textured R11 A+B+C
60x60 cm - 23 ⁵ / ₈ "x23 ⁵ / ₈ "	± 20 mm	Textured R11 A+B+C



COLOURED BODY PORCELAIN TILES | GRES PORCELLANATO COLORATO IN MASSA | Grès cérame coloré dans la masse | Durchgefärbtes Feinsteinzeug | Gres porcelánico coloreado en masa | Керамический гранит окрашенный в массе
RECTIFIED MONOCALIBER | RETTIFICATO MONOCALIBRO | Rectifié mono-calibre | Geschliffen einkalibrig | Rettificado monocalibril | Ретифицированный в одном калибре

NORDE Porcelain Tiles / Gres Porcellanato

MATTE SURFACE / SUPERFICIE MATT



60x120 cm 23⁵/₈"x47¹/₄"
 ASLM Norde Magnesio 60x120
 ASLN Norde Oro 60x120
 A45Z Norde Platino 60x120
 ASLO Norde Piombo 60x120

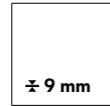

60x60 cm 23⁵/₈"x23⁵/₈"
 ASM6 Norde Magnesio 60x60
 ASM7 Norde Oro 60x60
 ASM8 Norde Platino 60x60
 ASM9 Norde Piombo 60x60

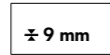

30x60 cm 11³/₄"x23⁵/₈"
 ASND Norde Magnesio 30x60
 ASNE Norde Oro 30x60
 ASNF Norde Platino 30x60
 ASNG Norde Piombo 30x60

GRIP SURFACE / SUPERFICIE GRIP

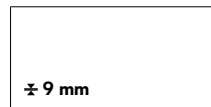

60x120 cm 23⁵/₈"x47¹/₄"
 ASMH Norde Magnesio 60x120 Grip
 ASMI Norde Oro 60x120 Grip
 A45Ø Norde Platino 60x120 Grip
 ASMJ Norde Piombo 60x120 Grip

ROCCIA SURFACE / SUPERFICIE ROCCIA

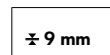
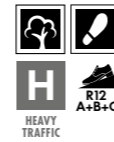

30x60 cm 11³/₄"x23⁵/₈"
 ASNA Norde Magnesio 30x60 Roccia
 ASNB Norde Oro 30x60 Roccia
 ASNC Norde Platino 30x60 Roccia
 A45Y Norde Piombo 30x60 Roccia

OUTDOOR PAVING ± 20 mm / PAVIMENTI DA ESTERNO ± 20 mm



60x120 cm 23⁵/₈"x47¹/₄"
 A5TV Norde Magnesio 60x120 20mm
 A5TW Norde Oro 60x120 20mm
 A451 Norde Platino 60x120 20mm
 A5TX Norde Piombo 60x120 20mm

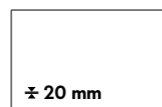

60x90 cm 23⁵/₈"x35³/₈"
 A5T2 Norde Magnesio 60x90 20mm
 A5T3 Norde Oro 60x90 20mm
 A5T4 Norde Platino 60x90 20mm
 A5T5 Norde Piombo 60x90 20mm

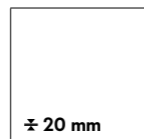

80x80 cm 31¹/₂"x31¹/₂"
 A56L Norde Magnesio 80x80 20mm
 A56M Norde Oro 80x80 20mm
 A56N Norde Platino 80x80 20mm
 A56O Norde Piombo 80x80 20mm

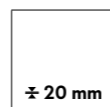

60x60 cm 23⁵/₈"x23⁵/₈"
 A5TY Norde Magnesio 60x60 20mm
 A5TZ Norde Oro 60x60 20mm
 A5TØ Norde Platino 60x60 20mm
 A5T1 Norde Piombo 60x60 20mm



**V3
 MODERATE
 VARIATION**

MATTE SURFACE | SUPERFICIE MATT | Surface Mat | Matt oberfläche | Superficie Mate | Матовая поверхность
GRIP SURFACE | SUPERFICIE GRIP | Surface grip | Grip oberfläche | Superficie Grip | Grip поверхность
TEXTURED SURFACE | SUPERFICIE STRUTTURATA | Surface structuré | Strukturiert oberfläche | Superficie estructurado | Структурная поверхность
OUTDOOR PAVING | PAVIMENTI DA ESTERNO | Sols d'extérieur | Bodenbeläge für Außenbereiche | Pavimentos para exteriores | Уличная плитка

MATTE / GRIP

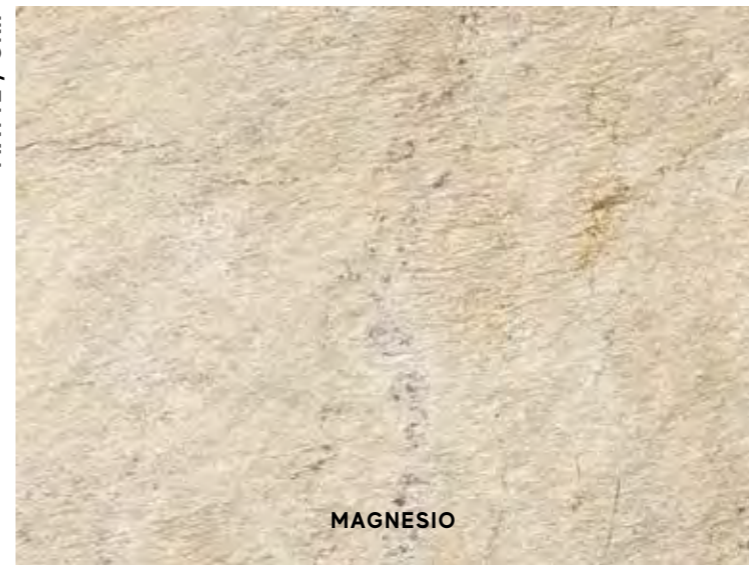

MAGNESIO



ORO



PLATINO

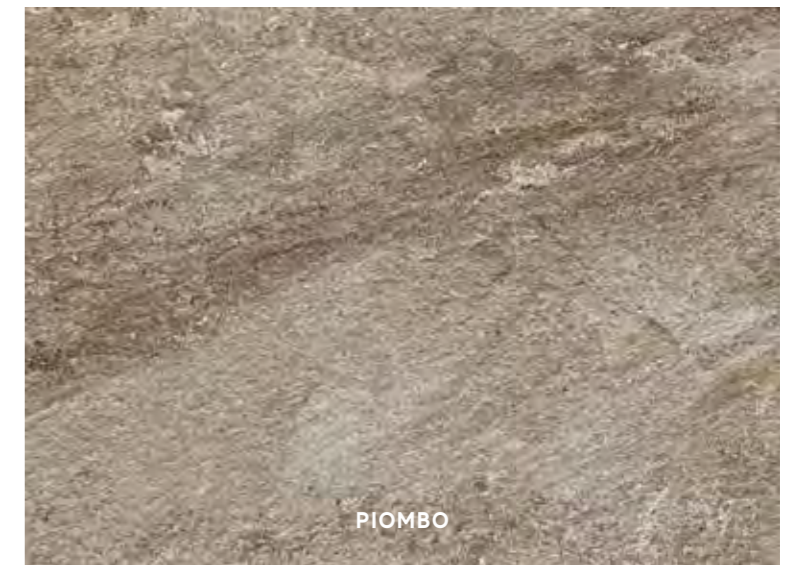

PIOMBO

ROCCIA



MAGNESIO



ORO

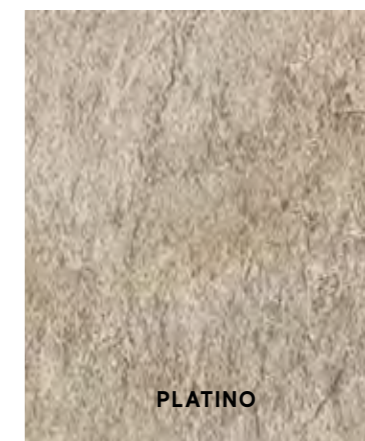

PLATINO

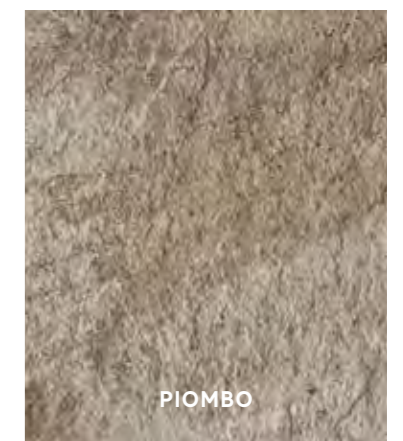

PIOMBO

OUTDOOR PAVING ± 20 mm



MAGNESIO



ORO

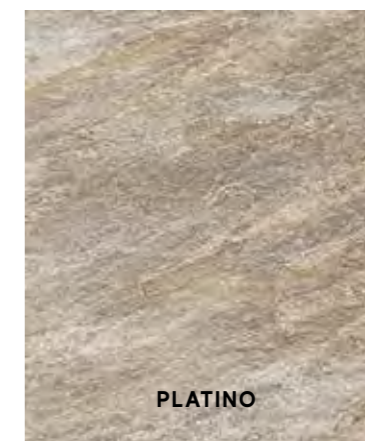

PLATINO

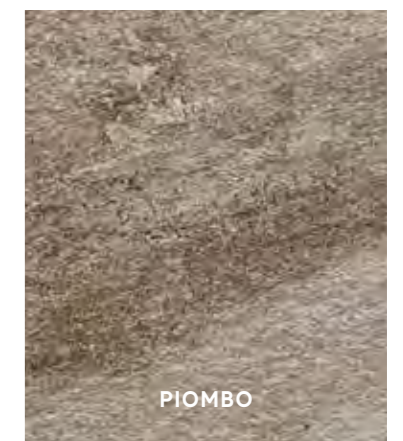

PIOMBO

STONE LOOK

STONE LOOK

NORDE Porcelain Tiles / Gres Porcellanato

DECOR RANGE / GAMMA DECORI



A59P Norde Magnesio Brick
30x60 - 11³/₄"x23³/₈"



A59Q Norde Oro Brick
30x60 - 11³/₄"x23³/₈"



A59R Norde Platino Brick
30x60 - 11³/₄"x23³/₈"



A59S Norde Piombo Brick
30x60 - 11³/₄"x23³/₈"



A596 Norde Magnesio Brick Corten *
39x27,8 - 15³/₈"x11"



A597 Norde Oro Brick Corten *
39x27,8 - 15³/₈"x11"

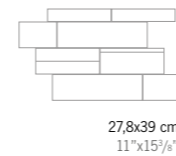

A598 Norde Platino Brick Corten *
39x27,8 - 15³/₈"x11"



A599 Norde Piombo Brick Corten *
39x27,8 - 15³/₈"x11"

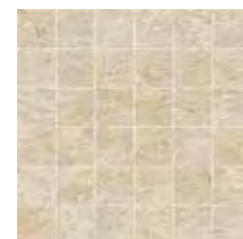

A59L Norde Magnesio Mosaico
30x30 - 11³/₄"x11³/₄"

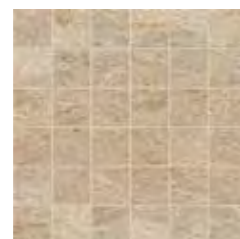

A59M Norde Oro Mosaico
30x30 - 11³/₄"x11³/₄"

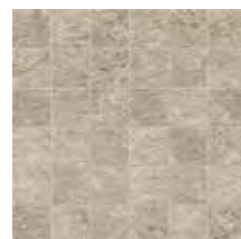

A59N Norde Platino Mosaico
30x30 - 11³/₄"x11³/₄"

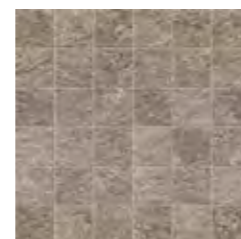

A59O Norde Piombo Mosaico
30x30 - 11³/₄"x11³/₄"

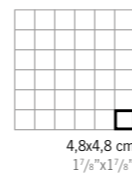

A58U Norde Magnesio Composizione Palladiana Grip **



A58V Norde Oro Composizione Palladiana Grip **



A58W Norde Platino Composizione Palladiana Grip **



A58X Norde Piombo Composizione Palladiana Grip **

* **MINIMUM ORDER: 8 M². VARIABLE TESSERA SIZE AND SHAPE WITH TUMBLED EDGE. WE RECOMMEND INSTALLATION WITH A JOINT OF NO LESS THAN 10 MM.**
 ORDINE MINIMO DI 8 MQ. DIMENSIONE E FORMA DELLE TESSERE VARIABILE CON BORDO BURATTATO. SI CONSIGLIA POSA CON FUGA NON INFERIORE A 10MM.
 Commande minimum: 8 qm. Abmessung und Form der Steine sind unterschiedlich, aber alle weisen getrimmte Kanten auf. Für die Verlegung wird eine Fugenbreite von nicht weniger als 10 mm empfohlen.
 Pedido mínimo de 8 m². Tamaño y forma variable de los mosaicos con borde burilado. Se recomienda colocación con junta de no menos de 10 mm.
 Минимальный объем заказа – 8 кв.м. Размер и форма chips варьируются, швы имеют выщербленные края. Рекомендуется укладка с межплиточным швом не менее 10 мм.

* **EXAMPLE OF LAYOUT MEASURING ABOUT 1 M².**
 ESEMPIO DI POSATO CORRISPONDENTE A CIRCA 1 MQ.
 Exemple de produit posé correspondant à 1 mètre carré environ.
 Verlegebeispiel für circa 1 qm.
 Ejemplo de colocación correspondiente aproximadamente a 1 m².
 Пример укладки, соответствующий примерно 1 кв.м.

TRIM TILES / PEZZI SPECIALI

p. 568

	Magnesio	A58Y	A59D	A59T	A59H	A59X	Battiscopa Sag. Scala		Elemento L Grip *	Elemento L Roccia *
							7,2x30 - 2 ⁷ / ₈ "x11 ³ / ₄ "	7,2x30 - 2 ⁷ / ₈ "x11 ³ / ₄ "		
							DX *	SX *		
	Magnesio	A58Y	A59D	A59T	A59H	A59X	A583	A587	A592	A6H2
	Oro	A58Z	A59E	A59U	A59I	A59Y	A584	A588	A593	A6H3
	Platino	A581	A59F	A59V	A59J	A59Z	A585	A589	A594	A6H4
	Piombo	A582	A59G	A59W	A59K	A591	A586	A59C	A595	A6H5

* THESE PARTS ARE SUPPLIED TO ORDER . I PEZZI SONO DISPONIBILI SU ORDINAZIONE ! Les pièces sont disponibles sur commande ! Die Teile sind auf Bestellung lieferbar ! Las piezas se hacen por encargo ! Изготавливаются на заказ

* **BLAZE CORTEN LAPPATO TESSERA INSERTED RANDOMLY IN FOUR OF THE SIX SHEETS CONTAINED IN EACH BOX.**
 TESSERA BLAZE CORTEN LAPPATO INSERITA IN MODO CASUALE IN QUATTRO DEI SEI FOGLI CONTENUTI IN OGNI SCATOLA.
 Tesselles Blaze Corten Lappato posées de manière aléatoire sur quatre des six feuilles contenues dans chaque boîte.
 Die Blaze Corten Lappato Steine werden nach dem Zufallsprinzip auf vier der sechs in jedem Karton enthaltenen Folien verklebt.
 Mosaico Blaze Corten Lappato insertado al azar en cuatro de las seis hojas que contiene cada caja.
 Чип Blaze Corten Lappato включен случайным образом в четыре из шести матриц, содержащихся в каждой коробке.

NORDE Porcelain Tiles / Gres Porcellanato

DECOR RANGE / GAMMA DECORI

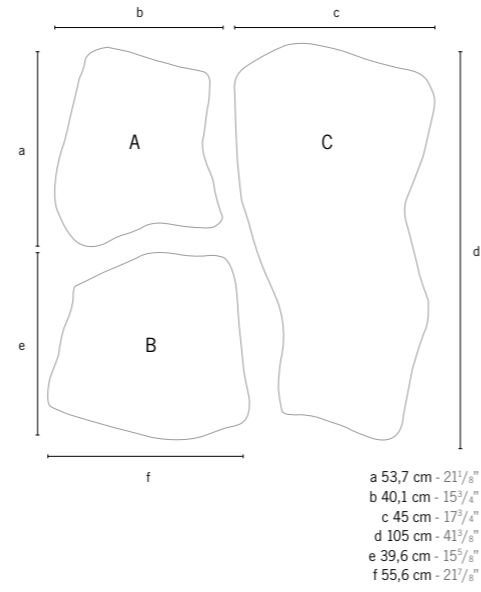

A58M Norde Magnesio Path A+B 20mm ■
54x54 - 21¹/₄"x21¹/₄"

A58Q Norde Magnesio Path C 20mm ■
55x109 - 21⁵/₈"x42⁷/₈"



A58O Norde Platino Path A+B 20mm ■
54x54 - 21¹/₄"x21¹/₄"

A58S Norde Platino Path C 20mm ■
55x109 - 21⁵/₈"x42⁷/₈"



A58N Norde Oro Path A+B 20mm ■
54x54 - 21¹/₄"x21¹/₄"

A58R Norde Oro Path C 20mm ■
55x109 - 21⁵/₈"x42⁷/₈"



A58P Norde Piombo Path A+B 20mm ■
54x54 - 21¹/₄"x21¹/₄"

A58T Norde Piombo Path C 20mm ■
55x109 - 21⁵/₈"x42⁷/₈"

■ WE RECOMMEND "DRY" INSTALLATION ON GRAVEL AND/OR GRASS.

SI CONSIGLIA POSA "A SECCO" SU GHIAIA E/O ERBA.
 Pose = à sec = sur gravillons et/ou herbe conseillée.
 Es wird eine Trockenverlegung auf Kies bzw. Rasen empfohlen.
 Se recomienda colocación «en seco» sobre grava o hierba.
 Рекомендуется «сухая» укладка на гравий и/или траву.



SEASTONE

PORCELAIN TILES



Porcelain Tiles / Gres Porcellanato

COLOURED BODY PORCELAIN TILES - RECTIFIED MONOCALIBER
GRES PORCELLANATO COLORATO IN MASSA - RETTIFICATO MONOCALIBRO

Sizes	Thickness	Surface finish
60x60 cm - 23 ⁵ / ₈ "x23 ⁵ / ₈ "	± 9 mm	Matte R9 A
30x60 cm - 11 ³ / ₄ "x23 ⁵ / ₈ "	± 9 mm	Matte R9 A

Outdoor Paving and Wet Areas OUTDOOR PAVING p. 554

Sizes	Thickness	Surface finish
60x60 cm - 23 ⁵ / ₈ "x23 ⁵ / ₈ "	± 20 mm	Textured R11 A+B+C



COLOURED BODY PORCELAIN TILES | GRES PORCELLANATO COLORATO IN MASSA | Grés cérame coloré dans la masse | Durchgefärbtes Feinsteinzeug | Gres porcelánico coloreado en masa | Керамический гранит окрашенный в массу
RECTIFIED MONOCALIBER | RETTIFICATO MONOCALIBRO | Rectifié mono-calibre | Geschliffen einkalibrig | Rettificado monocalibre | Ретифицированный в одном калибре

SEASTONE Porcelain Tiles / Gres Porcellanato

MATTE SURFACE / SUPERFICIE MATT

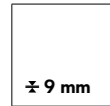

60x60 cm 23⁵/₈"x23⁵/₈"
8S24 Seastone Sand 60
8S22 Seastone Gray 60
8S21 Seastone Black 60

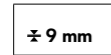

30x60 cm 11¹/₄"x23⁵/₈"
D139 Seastone Sand 30x60
D137 Seastone Gray 30x60
D136 Seastone Black 30x60

Modulo Multifornato

± 9 mm

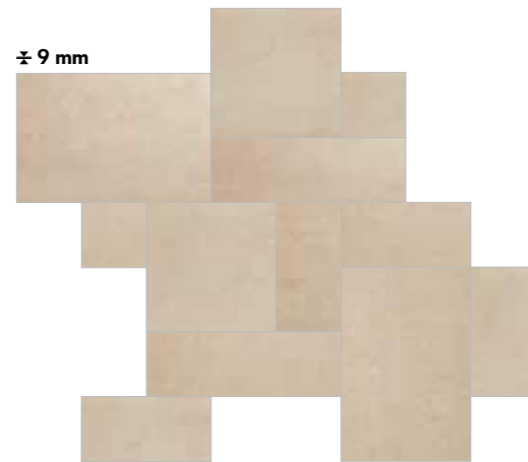

8S4D Seastone Sand Multifornato ***
8S46 Seastone Gray Multifornato ***
8S45 Seastone Black Multifornato ***

1 pcs 40x60 - 15³/₄"x23⁵/₈"
1 pcs 20x60 - 7⁷/₈"x23⁵/₈"
1 pcs 40x40 - 15³/₄"x15³/₄"
2 pcs 20x40 - 7⁷/₈"x15³/₄"
1 pcs 20x20 - 7⁷/₈"x7⁷/₈"

- To be ordered in multiples of 2
Ordinabile in multipli di 2
Peut être commandé en multiples de 2
Zum Bestellen als Vielfache von 2
Es posible efectuar pedidos en múltiplos de 2
Заказываются в количестве кратном 2

- The miniatures of the Multifornato Module are not in proportion.
I minimali nel Modulo Multifornato non sono in proporzione.
Les illustrations à échelle réduite dans le Module Multifornato ne sont pas proportionnelles.
Die Abbildungen im Modul Multifornato sind nicht verhältnismäßig.
Los miniaturas en el Módulo Multifornato no están en proporción.
Изображения Multifornato модуля не соблюдают пропорций.

- Two boxes are needed to create a complete Module. Each box contains:
Per comporre un Modulo intero occorrono due scatole. Ogni scatola contiene:
Deux cartons sont nécessaires pour composer un Module entier. Chaque carton contient :
Für ein vollständiges Modul benötigt man zwei Kartons. Jeder Karton enthält:
Para componer un módulo completo sirven dos cajas. Cada caja contiene:
Для составления одного модуля требуются две коробки. Каждая коробка содержит:

OUTDOOR PAVING ± 20 mm / PAVIMENTI DA ESTERNO ± 20 mm

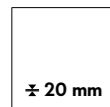
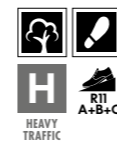

60x60 cm 23⁵/₈"x23⁵/₈"
8S41 Seastone Greige 60 LASTRA 20mm
8S42 Seastone Gray 60 LASTRA 20mm
AV0X Seastone Black 60 LASTRA 20mm

MATTE

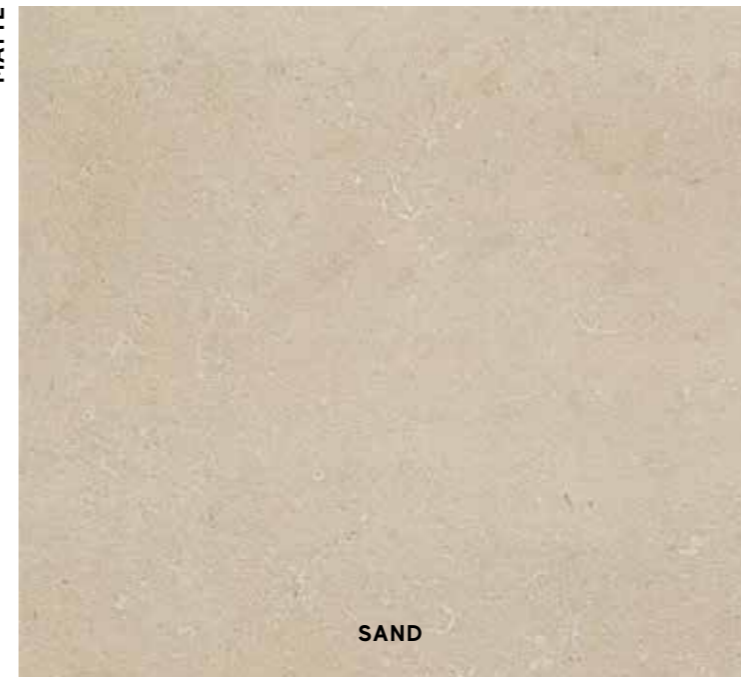

SAND

OUTDOOR PAVING ± 20 mm



GREIGE



GRAY

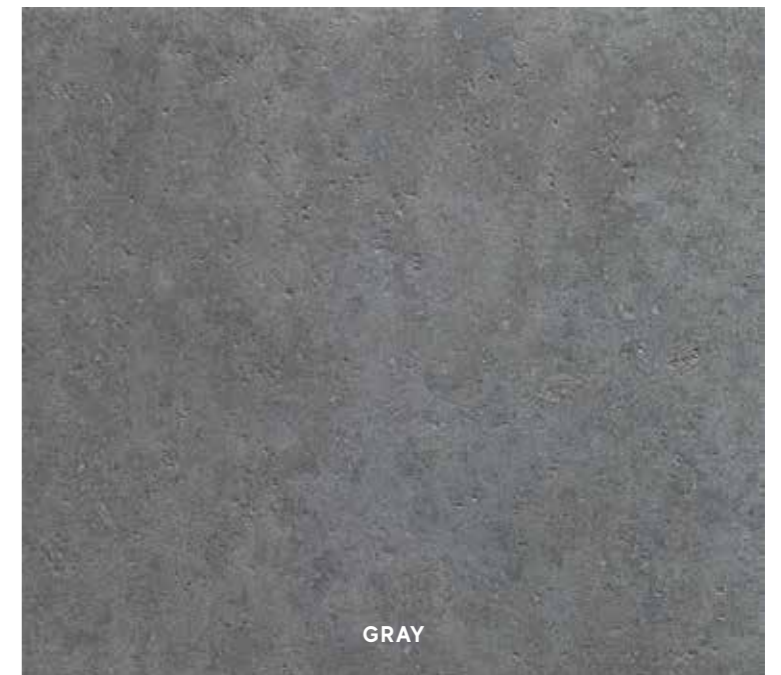

GRAY



BLACK

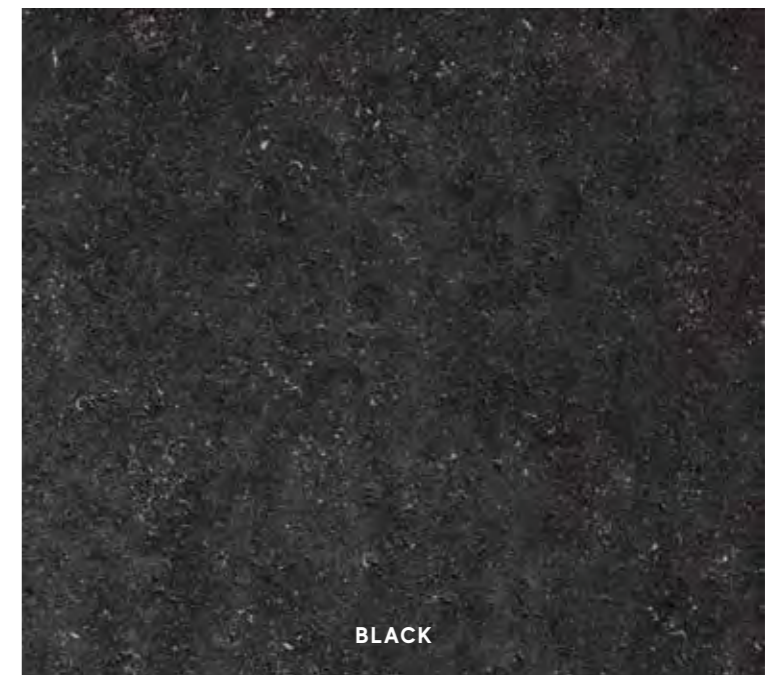

BLACK



V2
SLIGHT
VARIATION

SEASTONE Porcelain Tiles / Gres Porcellanato

DECOR RANGE / GAMMA DECORI

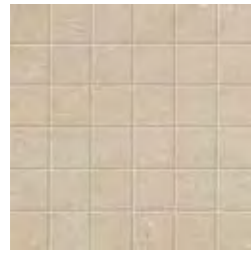

8581 Seastone Sand Mosaico
30x30 - 11³/₄"x11³/₄"



8571 Seastone Sand Mosaico Linea Mix2
30x60 - 11³/₄"x23⁵/₈"



8579 Seastone Gray Mosaico
30x30 - 11³/₄"x11³/₄"



8569 Seastone Gray Mosaico Linea Mix2
30x60 - 11³/₄"x23⁵/₈"

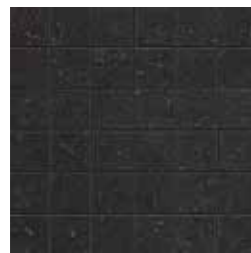

8578 Seastone Black Mosaico
30x30 - 11³/₄"x11³/₄"



8568 Seastone Black Mosaico Linea Mix2
30x60 - 11³/₄"x23⁵/₈"



8566 Seastone Sand Brick 60
30x60 - 11³/₄"x23⁵/₈"

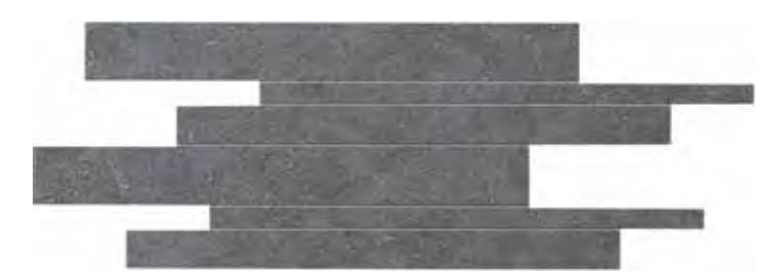

8564 Seastone Gray Brick 60
30x60 - 11³/₄"x23⁵/₈"



8563 Seastone Black Brick 60
30x60 - 11³/₄"x23⁵/₈"

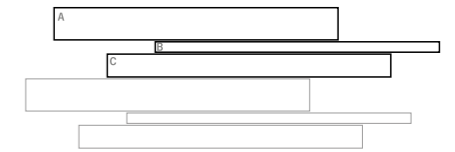

A 4,7x59,5 cm - 1⁷/₈"x11³/₈"
B 2,5x59,5 cm - 1"x23⁵/₈"
C 7,1x59,5 cm - 2⁷/₈"x23⁵/₈"

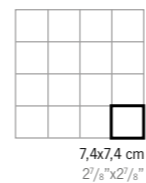
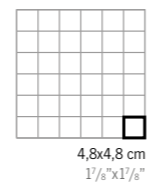

TRIM TILES / PEZZI SPECIALI

p. 568

UPEC p. 595

	Battiscopa 7,2x60 2 ⁷ / ₈ "x23 ⁵ / ₈ "	Gradino * 30x60 11 ³ / ₄ "x23 ⁵ / ₈ "	Scalino * 33x60 13"x23 ⁵ / ₈ "	Scalino Angolare * 33x33 13"x13"	Battiscopa Sag. Scala 7,2x30 - 2 ⁷ / ₈ "x11 ³ / ₄ "	
					DX *	SX *
Sand	8586	8591	85ØK	85ØO	ABMQ	ABMV
Gray	8584	8589	85ØH	85ØM	ABMO	ABMT
Black	8583	8588	85ØG	85ØL	ABMN	ABMS

* THESE PARTS ARE SUPPLIED TO ORDER | I PEZZI SONO DISPONIBILI SU ORDINAZIONE | Les pièces sont disponibles sur commande | Die Teile sind auf Bestellung lieferbar | Las piezas se hacen por encargo | Изготавливаются на заказ



atlas concorde

TRUST

PORCELAIN TILES



Porcelain Tiles / Gres Porcellanato

COLOURED BODY PORCELAIN TILES - RECTIFIED MONOCALIBER
GRES PORCELLANATO COLORATO IN MASSA - RETTIFICATO MONOCALIBRO

Sizes	Thickness	Surface finish
45x90 cm - 17 ³ / ₄ "x35 ³ / ₈ "	± 9 mm	Matte R10 A+B
22,5x90 cm - 8 ⁷ / ₈ "x35 ³ / ₈ "	± 9 mm	Matte R10 A+B
60x60 cm - 23 ⁵ / ₈ "x23 ⁵ / ₈ "	± 9 mm	Matte R10 A+B
40x60 cm - 15 ³ / ₄ "x23 ⁵ / ₈ "	± 9 mm	Matte R10 A+B
30x60 cm - 11 ³ / ₄ "x23 ⁵ / ₈ "	± 9 mm	Matte R10 A+B
20x60 cm - 7 ⁷ / ₈ "x23 ⁵ / ₈ "	± 9 mm	Matte R10 A+B
30x30 cm - 11 ³ / ₄ "x11 ³ / ₄ "	± 9 mm	Matte R10 A+B

Outdoor Paving and Wet Areas

OUTDOOR PAVING p. 554

Sizes	Thickness	Surface finish
30x60 cm - 11 ³ / ₄ "x23 ⁵ / ₈ "	± 9 mm	Grip R12 A+B+C
60x120 cm - 23 ⁵ / ₈ "x47 ¹ / ₄ "	± 20 mm	Textured R11 A+B+C
60x60 cm - 23 ⁵ / ₈ "x23 ⁵ / ₈ "	± 30 mm	Textured R11 A+B+C
60x60 cm - 23 ⁵ / ₈ "x23 ⁵ / ₈ "	± 20 mm	Textured R11 A+B+C
45x90 cm - 17 ³ / ₄ "x35 ³ / ₈ "	± 20 mm	Textured R11 A+B+C
30x60 cm - 11 ³ / ₄ "x23 ⁵ / ₈ "	± 20 mm	Textured R11 A+B+C



atlas concorde

TRUST Porcelain Tiles / Gres Porcellanato

MATTE SURFACE / SUPERFICIE MATT

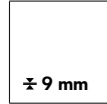

60x60 cm 23³/₈"x23³/₈"
AA8C Trust Moon 60
ACI1 Trust Ivory 60
ACI3 Trust Gold 60
ACI4 Trust Silver 60
ACI5 Trust Copper 60
ACI6 Trust Titanium 60

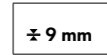

30x60 cm 11³/₄"x23³/₈"
D234 Trust Moon 30x60
D156 Trust Ivory 30x60
D157 Trust Gold 30x60
D158 Trust Silver 30x60
D159 Trust Copper 30x60
D160 Trust Titanium 30x60

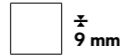

30x30 cm 11³/₄"x11³/₄"
AA8F Trust Moon 30
ACJ4 Trust Ivory 30
ACJ5 Trust Gold 30
ACJ6 Trust Silver 30
ACJ7 Trust Copper 30
ACJ8 Trust Titanium 30



45x90 cm 17¹/₈"x35³/₈"
AA8A Trust Moon 45x90
AKA6 Trust Ivory 45x90
AKA7 Trust Gold 45x90
AKA8 Trust Silver 45x90
AKA9 Trust Copper 45x90
AKBA Trust Titanium 45x90

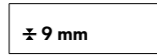

22,5x90 cm 8⁷/₈"x35³/₈"
AA8B Trust Moon 22,5x90
ANBZ Trust Ivory 22,5x90
ANBØ Trust Gold 22,5x90
ANB2 Trust Silver 22,5x90
ANB4 Trust Copper 22,5x90
ANB6 Trust Titanium 22,5x90

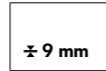

40x60 cm 15³/₄"x23³/₈"
AA8D Trust Moon 40x60
ACN1 Trust Ivory 40x60
ACN3 Trust Gold 40x60
ACN4 Trust Silver 40x60
ACN5 Trust Copper 40x60
ACN6 Trust Titanium 40x60

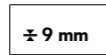

20x60 cm 7⁷/₈"x23³/₈"
AA8E Trust Moon 20x60
ACL1 Trust Ivory 20x60
ACL3 Trust Gold 20x60
ACL4 Trust Silver 20x60
ACL5 Trust Copper 20x60
ACL6 Trust Titanium 20x60

GRIP SURFACE / SUPERFICIE GRIP

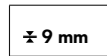
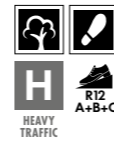

30x60 cm 11³/₄"x23³/₈"
D235 Trust Moon 30x60 Grip
D161 Trust Ivory 30x60 Grip
D162 Trust Gold 30x60 Grip
D163 Trust Silver 30x60 Grip
D164 Trust Copper 30x60 Grip
D165 Trust Titanium 30x60 Grip

OUTDOOR PAVING ± 20-30 mm / PAVIMENTI DA ESTERNO ± 20-30 mm

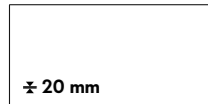
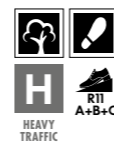

60x120 cm 23³/₈"x47¹/₄"
AY4E Trust Gold 60x120 LASTRA 20 mm
AY4D Trust Silver 60x120 LASTRA 20 mm
AY4F Trust Titanium 60x120 LASTRA 20 mm
AY4G Trust Ivory 60x120 LASTRA 20 mm

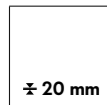

60x60 cm 23³/₈"x23³/₈"
ABL1 Trust Gold LASTRA 20 mm
ABLJ Trust Silver LASTRA 20 mm
ABLK Trust Titanium LASTRA 20 mm
AY4B Trust Ivory LASTRA 20 mm

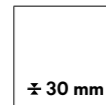

60x60 cm 23³/₈"x23³/₈"
AL7G Trust Gold LASTRA 30 mm
AL7H Trust Silver LASTRA 30 mm
AL7I Trust Titanium LASTRA 30 mm

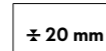

30x60 cm 11³/₄"x23³/₈"
ATZZ Trust Gold 30x60 LASTRA 20 mm
ACEI Trust Silver 30x60 LASTRA 20 mm
ATZØ Trust Titanium 30x60 LASTRA 20 mm
ATZY Trust Ivory 30x60 LASTRA 20 mm



45x90 cm 17¹/₈"x35³/₈"
ACHH Trust Gold 45x90 LASTRA 20 mm
ACHG Trust Silver 45x90 LASTRA 20 mm
ACHJ Trust Titanium 45x90 LASTRA 20 mm
AY4C Trust Ivory 45x90 LASTRA 20 mm



V2 SLIGHT VARIATION
Moon

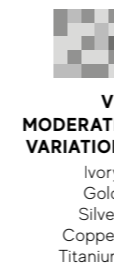

V3 MODERATE VARIATION
Ivory,
Gold,
Silver,
Copper,
Titanium

MATTE / GRIP



MOON



IVORY



GOLD



SILVER

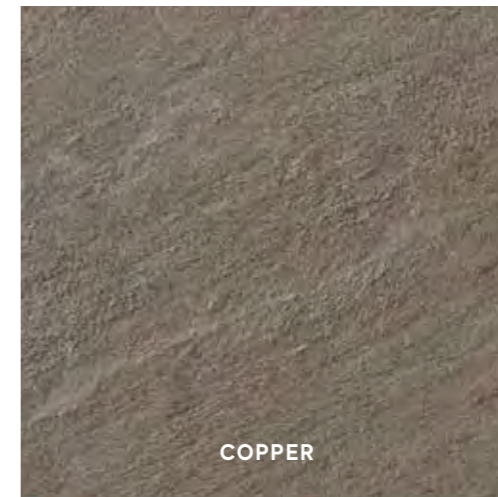

COPPER



TITANIUM

OUTDOOR PAVING ± 20 mm



SILVER



IVORY



GOLD

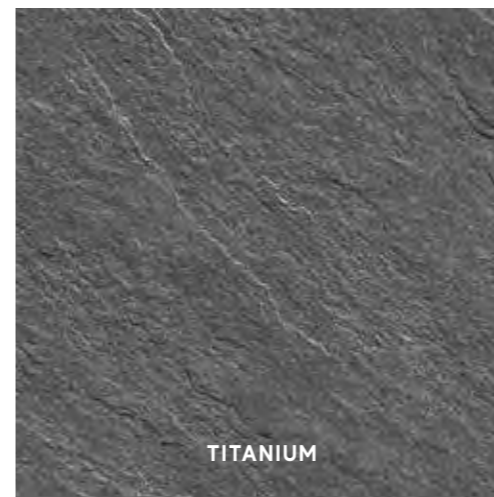

TITANIUM

TRUST Porcelain Tiles / Gres Porcellanato

DECOR RANGE / GAMMA DECORI



ABDW Trust Moon Mosaico
30x30 - 11³/₄"x11³/₄"



ACLA Trust Ivory Mosaico
30x30 - 11³/₄"x11³/₄"



ACLC Trust Gold Mosaico
30x30 - 11³/₄"x11³/₄"



ACLD Trust Silver Mosaico
30x30 - 11³/₄"x11³/₄"



ACLE Trust Copper Mosaico
30x30 - 11³/₄"x11³/₄"



ACLF Trust Titanium Mosaico
30x30 - 11³/₄"x11³/₄"



ABDX Trust Moon Brick
30x60 - 11³/₄"x23⁵/₈"



ACNA Trust Ivory Brick
30x60 - 11³/₄"x23⁵/₈"



ACNB Trust Gold Brick
30x60 - 11³/₄"x23⁵/₈"



ACNC Trust Silver Brick
30x60 - 11³/₄"x23⁵/₈"

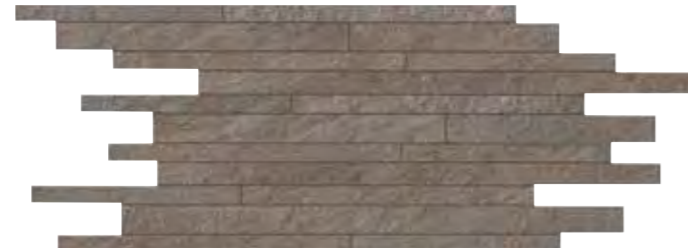

ACND Trust Copper Brick
30x60 - 11³/₄"x23⁵/₈"



ACNE Trust Titanium Brick
30x60 - 11³/₄"x23⁵/₈"

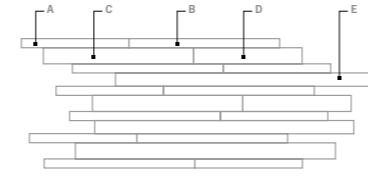

A 2,1x24,8 cm - 7/4"x9 1/4"
B 2,1x34,5 cm - 7/4"x13 3/4"
C 3,3x34,5 cm - 1 1/4"x13 3/4"
D 3,3x24,8 cm - 1 1/4"x9 1/4"
E 2,5x60 cm - 1"x23 5/8"

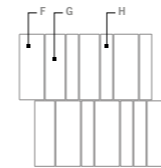

F 5,6x14,7 cm - 2 1/4"x5 7/4"
G 4,5x14,7 cm - 1 1/4"x5 7/4"
H 2,8x14,7 cm - 1 1/8"x5 7/4"

TRIM TILES / PEZZI SPECIALI

p. 568

UPEC p. 595

	Battiscopa 7,5x30 3"x11 ³ / ₄ "	Gradino * 30x30 11 ³ / ₄ "x11 ³ / ₄ "	Scalino * 33x60 13"x23 ⁵ / ₈ "	Scalino Angolare * 33x33 13"x13"	Battiscopa Sag. Scala 7,5x30 - 3"x11 ³ / ₄ "		Elemento L * 15x30 5 7/8"x11 ³ / ₄ "	Elemento L Grip * 15x60 H. 4 5 7/8"x23 ⁵ / ₈ " H. 1 1/8"
					DX *	SX *		
Moon	AAHW	AAHX	AAHY	AAHZ	AAHØ	AAH1	AAH5	AORD
Ivory	AD94	AD89	ACYU	ACYZ	AEAL	AEAM	ABØ8	AORA
Gold	AD95	AD9Ø	ACYV	ACYØ	AEAN	AEAO	AB1A	AWRB
Silver	AD96	AD91	ACYW	ACY1	AEAP	AEAQ	AB1B	AD3M
Copper	AD97	AD92	ACYX	ACY2	AEAR	AEAT	AB1C	AORB
Titanium	AD98	AD93	ACYY	ACY3	AEAU	AEAV	AB1D	AORC

* THESE PARTS ARE SUPPLIED TO ORDER | PEZZI SONO DISPONIBILI SU ORDINAZIONE | Les pièces sont disponibles sur commande | Die Teile sind auf Bestellung lieferbar | Las piezas se hacen por encargo | Изготавливаются на заказ



STONE LOOK

STONE LOOK



Arbor

PORCELAIN TILES

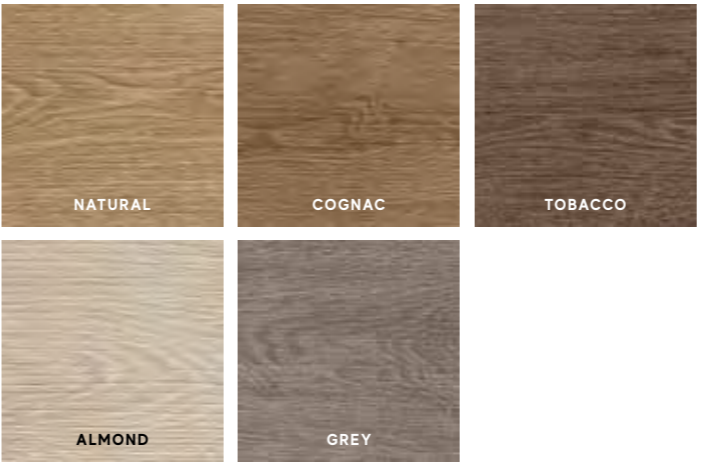

Porcelain Tiles / Gres Porcellanato

COLOURED BODY PORCELAIN TILES - RECTIFIED MONOCALIBER
GRES PORCELLANATO COLORATO IN MASSA - RETTIFICATO MONOCALIBRO

Sizes	Thickness	Surface finish
30x240 cm - 11 ³ / ₄ "x94 ¹ / ₂ "	± 9 mm	Matte R10 A
15x90 cm - 5 ⁷ / ₈ "x35 ³ / ₈ "	± 9 mm	Matte R10 A+B
7,5x60 cm - 3"x23 ⁵ / ₈ "	± 8,5 mm	Matte R10 A

Outdoor Paving and Wet Areas OUTDOOR PAVING p. 554

Sizes	Thickness	Surface finish
15x90 cm - 5 ⁷ / ₈ "x35 ³ / ₈ "	± 9 mm	Grip R11 A+B+C



COLOURED BODY PORCELAIN TILES | GRES PORCELLANATO COLORATO IN MASSA | Grès cérame coloré dans la masse | Durchgefärbtes Feinsteinzeug | Gres porcelánico coloreado en masa | Керамический гранит окрашенный в массе
RECTIFIED MONOCALIBER | RETTIFICATO MONOCALIBRO | Rectifié mono-calibre | Geschliffen einkalibrig | Rectificado monocalibre | Ретифицированный в одном калибре
NON RECTIFIED | NON RETTIFICATO | Non rectifié | Nicht rektifiziert | No rectificada | Неретифицированные

ARBOR Porcelain Tiles / Gres Porcellanato

MATTE SURFACE / SUPERFICIE MATT

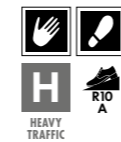

± 9 mm

30x240 cm 11³/₈"x94¹/₂"

AMHU Arbor Natural 30x240
AMHV Arbor Cognac 30x240
AMHX Arbor Tobacco 30x240

TOBACCO



COGNAC



NATURAL



ARBOR Porcelain Tiles / Gres Porcellanato

MATTE SURFACE / SUPERFICIE MATT



± 9 mm

15x90 cm 5⁷/₈"x35³/₈"

AMFM Arbor Almond 15x90
AMFQ Arbor Grey 15x90
AMFN Arbor Natural 15x90
AMFO Arbor Cognac 15x90
AMFR Arbor Tobacco 15x90

TOBACCO



COGNAC



NATURAL



GREY



ALMOND



NON RECTIFIED / NON RETTIFICATO

± 8,5 mm

7,5x60 cm 3"x23⁵/₈"

AN32 Arbor Natural 7,5x60
AN33 Arbor Cognac 7,5x60
AN34 Arbor Tobacco 7,5x60

TOBACCO



COGNAC



NATURAL



V3
MODERATE
VARIATION

MATTE SURFACE | SUPERFICIE MATT | Surface Mat | Matt oberfläche | Superficie Mate | Матовая поверхность
NON RECTIFIED | NON RETTIFICATO | Non rectifié | Nicht rektifiziert | No rectificada | Неретифицированные



V3
MODERATE
VARIATION

447

WOOD LOOK

WOOD LOOK

ARBOR Porcelain Tiles / Gres Porcellanato

GRIP SURFACE / SUPERFICIE GRIP



± 9 mm

15x90 cm 5⁷/₈"x35³/₈"
 AMFS Arbor Almond 15x90 Grip
 AMFV Arbor Grey 15x90 Grip
 AMFT Arbor Natural 15x90 Grip
 AMFU Arbor Cognac 15x90 Grip
 AMFW Arbor Tobacco 15x90 Grip

TOBACCO



COGNAC



NATURAL



GREY



ALMOND



DECOR RANGE / GAMMA DECORI



AN39 Arbor Tobacco Tatami
22,5x90 - 8⁷/₈"x35³/₈"



AN37 Arbor Cognac Tatami
22,5x90 - 8⁷/₈"x35³/₈"



AN36 Arbor Natural Tatami
22,5x90 - 8⁷/₈"x35³/₈"



AN38 Arbor Grey Tatami
22,5x90 - 8⁷/₈"x35³/₈"



AN35 Arbor Almond Tatami
22,5x90 - 8⁷/₈"x35³/₈"



2,3x90 cm
7¹/₈"x35³/₈"



V3
MODERATE
VARIATION

ARBOR Porcelain Tiles / Gres Porcellanato

DECOR RANGE / GAMMA DECORI



AN4E Arbor Tobacco Herringbone
36,2x41,2 - 14¹/₈"x16¹/₈"



AN4C Arbor Cognac Herringbone
36,2x41,2 - 14¹/₈"x16¹/₈"



AN4B Arbor Natural Herringbone
36,2x41,2 - 14¹/₈"x16¹/₈"



AN4D Arbor Grey Herringbone
36,2x41,2 - 14¹/₈"x16¹/₈"



AN4A Arbor Almond Herringbone
36,2x41,2 - 14¹/₈"x16¹/₈"

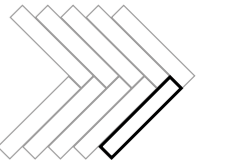

4,9x29 cm
1⁷/₈"x11³/₈"

TRIM TILES / PEZZI SPECIALI

p. 568

UPEC p. 595

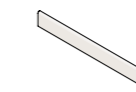

Battiscopa Digitale
7,2x90
2⁷/₈"x35³/₈"



Battiscopa Digitale Sag. Scala
7,2x30 - 2⁷/₈"x11³/₈"

		DX *	SX *
Almond	ANWM	ANXB	ANW6
Natural	ANWN	ANXC	ANW7
Cognac	ANWO	ANXD	ANW8
Grey	ANWP	ANXE	ANW9
Tobacco	ANWQ	ANXF	ANXA

* THESE PARTS ARE SUPPLIED TO ORDER | I PEZZI SONO DISPONIBILI SU ORDINAZIONE | Les pièces sont disponibles sur commande | Die Teile sind auf Bestellung lieferbar | Las piezas se hacen por encargo | Изготавливаются на заказ



atlas concorde

AXI
PORCELAIN TILES

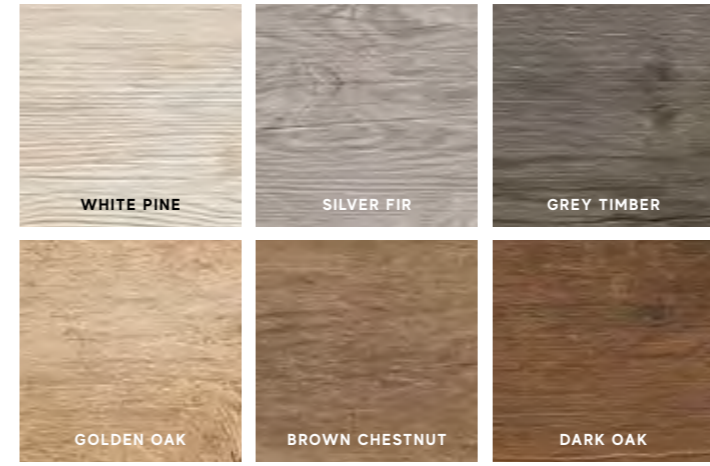

Porcelain Tiles / Gres Porcellanato

COLOURED BODY PORCELAIN TILES - RECTIFIED MONOCALIBER
GRES PORCELLANATO COLORATO IN MASSA - RETTIFICATO MONOCALIBRO

Sizes	Thickness	Surface finish
22,5x90 cm - 8 ⁷ / ₈ "x35 ³ / ₈ "	± 9,5 mm	Matte R10 A+B

Outdoor Paving and Wet Areas OUTDOOR PAVING p. 554

Sizes	Thickness	Surface finish
22,5x90 cm - 8 ⁷ / ₈ "x35 ³ / ₈ "	± 9,5 mm	Textured R11 A+B+C
60x60 cm - 23 ⁵ / ₈ "x23 ⁵ / ₈ "	± 20 mm	Textured R11 A+B+C
45x90 cm - 17 ³ / ₄ "x35 ³ / ₈ "	± 20 mm	Textured R11 A+B+C



atlas concorde

COLOURED BODY PORCELAIN TILES | GRES PORCELLANATO COLORATO IN MASSA | Grés cérame coloré dans la masse | Durchgefärbtes Feinsteinzeug | Gres porcelánico coloreado en masa | Керамический гранит окрашенный в массе
RECTIFIED MONOCALIBER | RETTIFICATO MONOCALIBRO | Rectifié mono-calibre | Geschliffen einkalibrig | Rettificado monocalibril | Ретифицированный в одном калибре

AXI Porcelain Tiles / Gres Porcellanato

MATTE SURFACE / SUPERFICIE MATT

± 9,5 mm

22,5x90 cm 8⁷/₈"x35³/₈"

- AS3B Axi White Pine 22,5x90 R10
- AS3D Axi Silver Fir 22,5x90 R10
- AS3E Axi Grey Timber 22,5x90 R10
- AS3C Axi Golden Oak 22,5x90 R10
- AS3A Axi Brown Chestnut 22,5x90 R10
- AS3F Axi Dark Oak 22,5x90 R10

WHITE PINE



SILVER FIR



GREY TIMBER



GOLDEN OAK



BROWN CHESTNUT



DARK OAK



AXI Porcelain Tiles / Gres Porcellanato

TEXTURED SURFACE / SUPERFICIE STRUTTURATA

± 9,5 mm

22,5x90 cm 8⁷/₈"x35³/₈"

- AE70 Axi White Pine Strutturato
- AE7Q Axi Silver Fir Strutturato
- AE7R Axi Grey Timber Strutturato
- AE7P Axi Golden Oak Strutturato
- AE7S Axi Brown Chestnut Strutturato
- AE7T Axi Dark Oak Strutturato

WHITE PINE



SILVER FIR



GREY TIMBER



GOLDEN OAK



BROWN CHESTNUT



DARK OAK



OUTDOOR PAVING ± 20 mm / PAVIMENTI DA ESTERNO ± 20 mm

± 20 mm

60x60 cm 23³/₈"x23³/₈"

- AE7G Axi Grey Timber 60 LASTRA 20mm
- AE7H Axi Brown Chestnut 60 LASTRA 20mm

± 20 mm

45x90 cm 17⁷/₈"x35³/₈"

- ADU5 Axi White Pine 45x90 LASTRA 20mm
- ADU7 Axi Grey Timber 45x90 LASTRA 20mm
- ADU6 Axi Golden Oak 45x90 LASTRA 20mm
- ADU8 Axi Brown Chestnut 45x90 LASTRA 20mm

GREY TIMBER

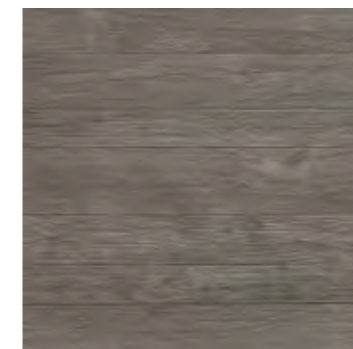

BROWN CHESTNUT

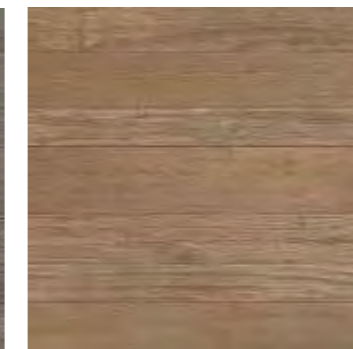

TEXTURED SURFACE / SUPERFICIE STRUTTURATA | Surface structurée | Strukturiert oberfläche | Superficie estructurado | Структурная поверхность
OUTDOOR PAVING / PAVIMENTI DA ESTERNO | Sols d'extérieur | Bodenbeläge für Außenbereiche | Pavimentos para exteriores | Уличная плитка

MATTE SURFACE / SUPERFICIE MATT | Surface Mat | Matt oberfläche | Superficie Mate | Матовая поверхность
TEXTURED SURFACE / SUPERFICIE STRUTTURATA | Surface structurée | Strukturiert oberfläche | Superficie estructurado | Структурная поверхность

AXI Porcelain Tiles / Gres Porcellanato

DECOR RANGE / GAMMA DECORI



AMWG Axi White Pine
Tatami
22,5x90 - 8 7/8" x 35 3/8"



AMWI Axi Silver Fir
Tatami
22,5x90 - 8 7/8" x 35 3/8"



AMWJ Axi Grey Timber
Tatami
22,5x90 - 8 7/8" x 35 3/8"



AMWH Axi Golden Oak
Tatami
22,5x90 - 8 7/8" x 35 3/8"



AMWK Axi Brown Chestnut
Tatami
22,5x90 - 8 7/8" x 35 3/8"



AMWL Axi Dark Oak
Tatami
22,5x90 - 8 7/8" x 35 3/8"



AMV7 Axi White Pine Mosaico 3D *
35x35 - 13 3/4" x 13 3/4"



AMV1 Axi Silver Fir Mosaico 3D *
35x35 - 13 3/4" x 13 3/4"

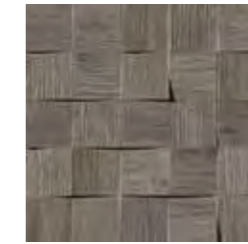

AMV4 Axi Grey Timber Mosaico 3D *
35x35 - 13 3/4" x 13 3/4"



AMVØ Axi Golden Oak Mosaico 3D *
35x35 - 13 3/4" x 13 3/4"



AMV8 Axi Brown Chestnut Mosaico 3D *
35x35 - 13 3/4" x 13 3/4"

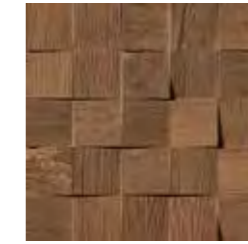

AMV9 Axi Dark Oak Mosaico 3D *
35x35 - 13 3/4" x 13 3/4"



AMWM Axi White Pine Treccia
28x53 - 11" x 20 7/8"



AMWO Axi Silver Fir Treccia
28x53 - 11" x 20 7/8"



AMWP Axi Grey Timber Treccia
28x53 - 11" x 20 7/8"



AMWN Axi Golden Oak Treccia
28x53 - 11" x 20 7/8"



AMWQ Axi Brown Chestnut Treccia
28x53 - 11" x 20 7/8"



AMWR Axi Dark Oak Treccia
28x53 - 11" x 20 7/8"



ANIO Axi Bottone Decorato Mix 4
7,5x7,5 - 3" x 3"



AMWA White Pine
Brick 3D *
20x44 - 7 7/8" x 17 3/8"



AMWC Axi Silver Fir
Brick 3D *
20x44 - 7 7/8" x 17 3/8"



AMWD Axi Grey Timber
Brick 3D *
20x44 - 7 7/8" x 17 3/8"



AMWB Axi Golden Oak
Brick 3D *
20x44 - 7 7/8" x 17 3/8"



AMWE Axi Brown Chestnut
Brick 3D *
20x44 - 7 7/8" x 17 3/8"



AMWF Axi Dark Oak
Brick 3D *
20x44 - 7 7/8" x 17 3/8"

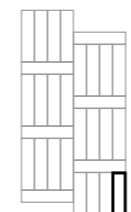

3,3x14 cm
1 1/4" x 5 1/2"

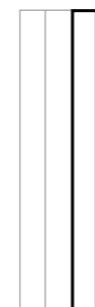

7,2x89,5 cm
2 7/8" x 35 1/4"

* **MULTI-THICKNESS MOSAIC, CLOSE JOINT INSTALLATION WITHOUT GROUTING.**
MOSAICO MULTISPESORE, POSA SENZA STUCCATURA A GIUNTO UNITO.
Mosaïque multi-épaisseur, pose sans mortier avec joint nul.
Mosaik mit verschiedenen Stärken, fugenlose Verlegung ohne Mörtel.
Mosaico multiespesor, colocación sin mástique y sin juntas.
Мозаика разной толщины; укладка встык без затирки швов.

THE DECORATION CAN ONLY BE LAID ON THE WALL | IL DECORO SI PUÒ POSARE SOLO A RIVESTIMENTO
Décor uniquement mural | Das Dekor kann nur an der Wand verlegt werden | La decoración se puede colocar únicamente en paredes | Декор может быть уложен только на стену.

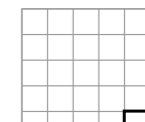

6,9x6,9 cm
2 3/4" x 2 3/4"

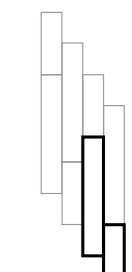

5x29 cm - 2" x 11 3/8"
5x15 cm - 2" x 5 7/8"

AXI Porcelain Tiles / Gres Porcellanato

DECOR RANGE / GAMMA DECORI



ANIT Axi Brown Chestnut Rosone Mini ♦
45x45 - 17³/₈"x17³/₈"



Layout 1



Layout 2

♦ TO BE ORDERED IN MULTIPLES OF 4. ORDINABILE IN MULTIPLI DI 4
Peut être commandé en multiples de 4. Zum Bestellen als Vielfache von 4. Es posible efectuar pedidos en múltiplos de 4. Заказываются в количестве кратном 4.



ANIQ Axi Angolo Elegance ♦
90x90 - 35³/₈"x35³/₈"



ANIS Axi Fascia Elegance ♦
90x90 - 35³/₈"x35³/₈"

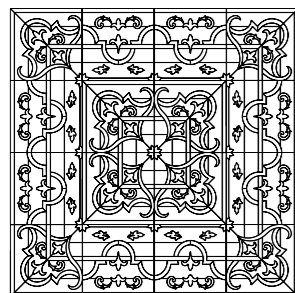

Layout 1
360x360 - 141³/₄"x141³/₄"

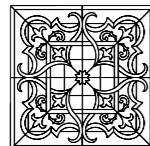

Layout 2
180x180 - 70⁷/₈"x70⁷/₈"

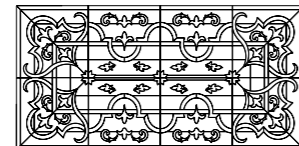

Layout 3
180x360 - 70⁷/₈"x141³/₄"

TRIM TILES / PEZZI SPECIALI

p. 568

UPEC p. 595

	Battiscopa 7,2x90 2 ⁷ / ₈ "x35 ³ / ₈ "	Scalino * 22,5x90 8 ⁷ / ₈ "x35 ³ / ₈ "	Scalino Angolare 22,5x22,5 - 8 ⁷ / ₈ "x8 ⁷ / ₈ "		Battiscopa Sag. Scala 7,2x30 - 2 ⁷ / ₈ "x11 ³ / ₄ "		Elemento L Strutturato * 22,5x90 H. 4 8 ⁷ / ₈ "x35 ³ / ₈ " H. 1 ¹ / ₈ "
			DX *	SX *	DX *	SX *	
White Pine	ANLH	ANLO	ANLV	ANL1	ANMA	ANMG	ANMM
Silver Fir	ANLK	ANLQ	ANLX	ANL2	ANMC	ANML	ANMO
Golden Oak	ANLJ	ANLP	ANLW	ANL5	ANMB	ANMJ	ANMN
Brown Chestnut	ANLM	ANLT	ANLZ	ANL9	ANME	ANMH	ANMQ
Dark Oak	ANLN	ANLU	ANLØ	ANL7	ANMF	ANMI	ANMR
Grey Timber	ANLL	ANLR	ANLY	ANL4	ANMD	ANMK	ANMP

* THESE PARTS ARE SUPPLIED TO ORDER | I PEZZI SONO DISPONIBILI SU ORDINAZIONE | Les pièces sont disponibles sur commande | Die Teile sind auf Bestellung lieferbar | Las piezas se hacen por encargo | Изготавливаются на заказ



WOOD LOOK



atlas concorde

ETIC

PORCELAIN TILES

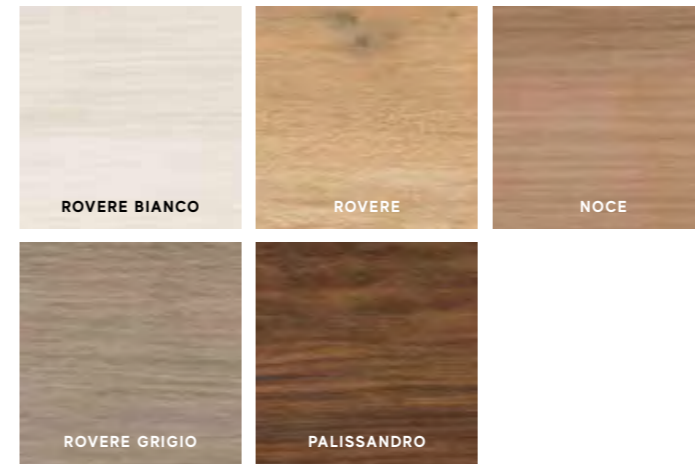

Porcelain Tiles / Gres Porcellanato

COLOURED BODY PORCELAIN TILES - RECTIFIED MONOCALIBER
GRES PORCELLANATO COLORATO IN MASSA - RETTIFICATO MONOCALIBRO

Sizes	Thickness	Surface finish
22,5x90 cm - 8 ⁷ / ₈ "x35 ³ / ₈ "	± 9,5 mm	Matte R9 A
15x90 cm - 5 ⁷ / ₈ "x35 ³ / ₈ "	± 9,5 mm	Matte R9 A
11x90 cm - 4 ³ / ₈ "x35 ³ / ₈ "	± 9 mm	Matte R9 A



atlas concorde

ETIC Porcelain Tiles / Gres Porcellanato

MATTE SURFACE / SUPERFICIE MATT



± 9,5 mm

22,5x90 cm 8⁷/₈"x35³/₈"
 AJ8D Etic Rovere 22,5x90
 AJ8F Etic Noce 22,5x90
 AJ8G Etic Palissandro 22,5x90
 AJ78 Etic Rovere Bianco 22,5x90
 AJ8H Etic Rovere Grigio 22,5x90

± 9,5 mm

15x90 cm 5⁷/₈"x35³/₈"
 AJ8P Etic Rovere 15x90
 AJ8N Etic Noce 15x90
 AJ8Q Etic Palissandro 15x90
 AJ68 Etic Rovere Bianco 15x90
 AJ69 Etic Rovere Grigio 15x90

± 9 mm

11x90 cm 4³/₈"x35³/₈"
 AJ8J Etic Rovere 11x90
 AJ8K Etic Noce 11x90
 AJ8L Etic Palissandro 11x90
 AJ65 Etic Rovere Bianco 11x90
 AJ66 Etic Rovere Grigio 11x90

ROVERE



NOCE



PALISSANDRO



ROVERE BIANCO



ROVERE GRIGIO



ETIC Porcelain Tiles / Gres Porcellanato

DECOR RANGE / GAMMA DECORI



AM8D Etic Rovere
Tatami 22,5x90
22,5x90 - 8⁷/₈"x35³/₈"



AM8F Etic Noce
Tatami 22,5x90
22,5x90 - 8⁷/₈"x35³/₈"



AM8H Etic Palissandro
Tatami 22,5x90
22,5x90 - 8⁷/₈"x35³/₈"



AM8C Etic Rovere Bianco
Tatami 22,5x90
22,5x90 - 8⁷/₈"x35³/₈"



AM8G Etic Rovere Grigio
Tatami 22,5x90
22,5x90 - 8⁷/₈"x35³/₈"

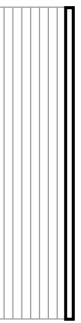

2,3x90 cm
7/8"x35³/₈"



V2
SLIGHT
VARIATION
Rovere Bianco



V3
MODERATE
VARIATION
Rovere,
Rovere Grigio,
Noce,
Palissandro

ETIC Porcelain Tiles / Gres Porcellanato

DECOR RANGE / GAMMA DECORI



AM8K Etic Rovere Cassettone 45
45x45 - 17³/₄"x17³/₄"



AM8M Etic Noce Cassettone 45
45x45 - 17³/₄"x17³/₄"



AM8O Etic Palissandro Cassettone 45
45x45 - 17³/₄"x17³/₄"

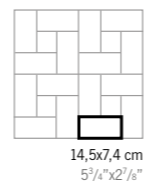

AM8J Etic Rovere Bianco Cassettone 45
45x45 - 17³/₄"x17³/₄"



AM8N Etic Rovere Grigio Cassettone 45
45x45 - 17³/₄"x17³/₄"



AM8R Etic Rovere Bottone 7x7
7x7 - 2³/₄"x2³/₄"



AM8T Etic Noce Bottone 7x7
7x7 - 2³/₄"x2³/₄"



AM8V Etic Palissandro Bottone 7x7
7x7 - 2³/₄"x2³/₄"



AM8Q Etic Rovere Bianco Bottone 7x7
7x7 - 2³/₄"x2³/₄"



AM8U Etic Rovere Grigio Bottone 7x7
7x7 - 2³/₄"x2³/₄"



ADQ2 Marvel Statuario Select Angolo 7x7 Lappato
7x7 - 2³/₄"x2³/₄"



ADQ6 Marvel Grey Fleury Angolo 7x7 Lappato
7x7 - 2³/₄"x2³/₄"



ADQ7 Marvel Noir St. Laurent Angolo 7x7 Lappato
7x7 - 2³/₄"x2³/₄"



ADQ4 Marvel Crema Delicato Angolo 7x7 Lappato
7x7 - 2³/₄"x2³/₄"



ADQ3 Marvel Travertino Alabastrino Angolo 7x7 Lappato
7x7 - 2³/₄"x2³/₄"



ADQ5 Marvel Travertino Silver Angolo 7x7 Lappato
7x7 - 2³/₄"x2³/₄"



ASJ3 Marvel Calacatta Angolo 7x7 Lappato
7x7 - 2³/₄"x2³/₄"



ASJ4 Marvel Moon Angolo 7x7 Lappato
7x7 - 2³/₄"x2³/₄"



ASJ8 Marvel Grey Angolo 7x7 Lappato
7x7 - 2³/₄"x2³/₄"



ASJ5 Marvel Champagne Angolo 7x7 Lappato
7x7 - 2³/₄"x2³/₄"



ASJ6 Marvel Beige Angolo 7x7 Lappato
7x7 - 2³/₄"x2³/₄"



ASJ7 Marvel Bronze Angolo 7x7 Lappato
7x7 - 2³/₄"x2³/₄"

TRIM TILES / PEZZI SPECIALI

p. 568

UPEC p. 595

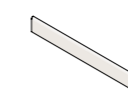

Battiscopa
7,2x90
2⁷/₈"x35³/₈"

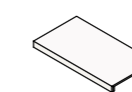

Scalino *
22,5x90
8⁷/₈"x35³/₈"

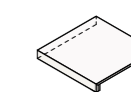

Scalino Angolare
22,5x22,5 - 8⁷/₈"x8⁷/₈"



Battiscopa Sag. Scala
7,2x30 - 2⁷/₈"x11³/₄"

			Scalino Angolare 22,5x22,5 - 8 ⁷ / ₈ "x8 ⁷ / ₈ "		Battiscopa Sag. Scala 7,2x30 - 2 ⁷ / ₈ "x11 ³ / ₄ "	
			DX *	SX *	DX *	SX *
	Rovere Bianco	AM75	ANAE	ANCV	ANAL	ANCN
	Rovere	AM76	ANAF	ANCW	ANCH	ANCO
	Noce	AM78	ANAH	ANCZ	ANCI	ANCI
	Rovere Grigio	AM79	ANAI	ANC1	ANCK	ANCR
	Palissandro	AM8A	ANAJ	ANCØ	ANCL	ANCS

* THESE PARTS ARE SUPPLIED TO ORDER | PEZZI SONO DISPONIBILI SU ORDINAZIONE | Les pièces sont disponibles sur commande | Die Teile sind auf Bestellung lieferbar | Las piezas se hacen por encargo | Изготавливаются на заказ



atlas concorde



Porcelain Tiles / Gres Porcellanato

COLOURED BODY PORCELAIN TILES - RECTIFIED MONOCALIBER
GRES PORCELLANATO COLORATO IN MASSA - RETTIFICATO MONOCALIBRO

Sizes	Thickness	Surface finish
25x150 cm - 9 ⁷ / ₈ "x59"	± 9 mm	Matte R9 A
22,5x90 cm - 8 ⁷ / ₈ "x35 ³ / ₈ "	± 9 mm	Matte R9 A
15x90 cm - 5 ⁷ / ₈ "x35 ³ / ₈ "	± 9 mm	Matte R9 A

Outdoor Paving and Wet Areas OUTDOOR PAVING p. 554

Sizes	Thickness	Surface finish
22,5x90 cm - 8 ⁷ / ₈ "x35 ³ / ₈ "	± 9 mm	Grip R11 A+B+C
30x120 cm - 11 ³ / ₄ "x47 ¹ / ₄ "	± 20 mm	Textured R11 A+B+C



ETIC PRO Porcelain Tiles / Gres Porcellanato

MATTE SURFACE / SUPERFICIE MATT



± 9 mm

± 9 mm

± 9 mm

25x150 cm 9^{7/8}"x59"

AV41 Etic Rovere Venice 25x150
AV4K Etic Noce Hickory 25x150

22,5x90 cm 8^{7/8}"x35^{3/8}"

AV4M Etic Rovere Venice 22,5x90
AV4O Etic Noce Hickory 22,5x90

15x90 cm 5^{7/8}"x35^{3/8}"

D183 Etic Rovere Venice 15x90
D185 Etic Noce Hickory 15x90

ROVERE VENICE



NOCE HICKORY

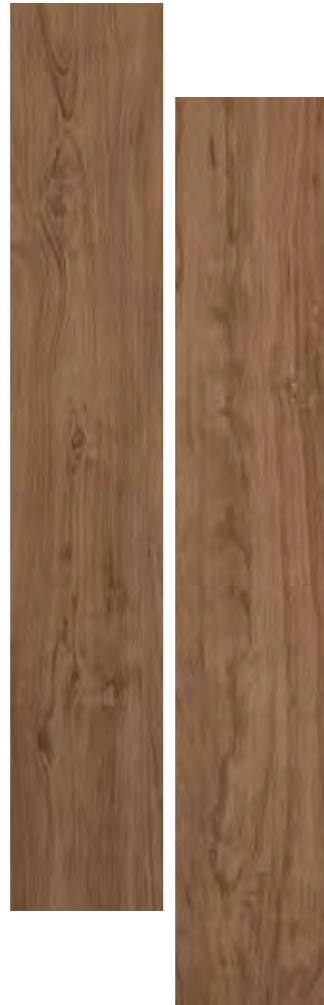

ETIC PRO Porcelain Tiles / Gres Porcellanato

GRIP SURFACE / SUPERFICIE GRIP



± 9 mm

22,5x90 cm 8^{7/8}"x35^{3/8}"

AV4Y Etic Rovere Venice 22,5x90 Grip
AV4Ø Etic Noce Hickory 22,5x90 Grip

ROVERE VENICE



NOCE HICKORY



OUTDOOR PAVING ± 20 mm / PAVIMENTI DA ESTERNO ± 20 mm

± 20 mm

30x120 cm 11^{3/4}"x47^{1/4}"

AV42 Etic Rovere Venice 30x120 LASTRA 20mm
AV44 Etic Noce Hickory 30x120 LASTRA 20mm

ROVERE VENICE



NOCE HICKORY



V3
MODERATE
VARIATION

GRIP SURFACE | SUPERFICIE GRIP | Surface grip | Grip oberfläche | Superficie Grip | Grip поверхность
OUTDOOR PAVING | PAVIMENTI DA ESTERNO | Sols d'extérieur | Bodenbeläge für Außenbereiche | Pavimentos para exteriores | Уличная плитка



V3
MODERATE
VARIATION

ETIC PRO Porcelain Tiles / Gres Porcellanato

DECOR RANGE / GAMMA DECORI



AWYE Etic Rovere Venice Chevron Tatami A+B
74x22,2 - 29³/₈"x8⁵/₈"

AWYG Etic Noce Hickory Chevron Tatami A+B
74x22,2 - 29³/₈"x8⁵/₈"



AWVZ Etic Rovere Venice Tatami
22,5x90 - 8⁷/₈"x35³/₈"



AWV1 Etic Noce Hickory Tatami
22,5x90 - 8⁷/₈"x35³/₈"



AWYI Etic Rovere Venice Industrial 3D *
44x28,5 - 17³/₈"x11¹/₄"



AWYK Etic Noce Hickory Industrial 3D *
44x28,5 - 17³/₈"x11¹/₄"

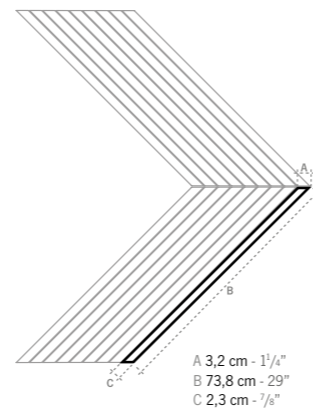
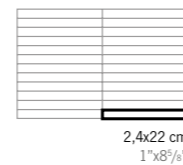

* **MULTI-THICKNESS MOSAIC, CLOSE JOINT INSTALLATION WITHOUT GROUTING.**
 MOSAICO MULTISPESORE, POSA SENZA STUCCATURA A GIUNTO UNITO.
 Mosaïque multi-épaisseur, pose sans mastic avec joint nul.
 Mosaik mit verschieden Stärken, fugenlose Verlegung ohne Mörtel.
 Mosaico multiespesor, colocación sin mástique y sin juntas.
 Мозаика разной толщины; укладка встык без затирки швов.



AWV3 Etic Rovere Venice Herringbone
36,2x41,2 - 14¹/₈"x16¹/₈"



AWV5 Etic Noce Hickory Herringbone
36,2x41,2 - 14¹/₈"x16¹/₈"

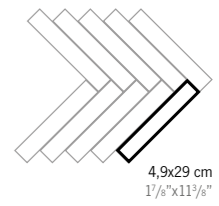

AWV7 Etic Rovere Venice Chevron A+B
35x34,5 - 13³/₄"x13⁵/₈"



AWV9 Etic Noce Hickory Chevron A+B
35x34,5 - 13³/₄"x13⁵/₈"

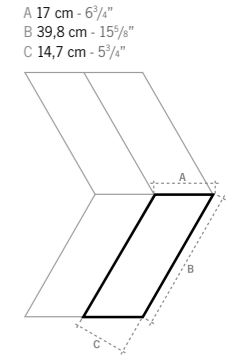

TRIM TILES / PEZZI SPECIALI

p. 568

UPEC p. 595

	Battiscopa 7,2x90 2 ⁷ / ₈ "x35 ³ / ₈ "	Scalino * 22,5x90 8 ⁷ / ₈ "x35 ³ / ₈ "	Scalino * 33x150 13"x59"	Scalino Angolare 22,5x22,5 - 8 ⁷ / ₈ "x8 ⁷ / ₈ "		Battiscopa Sag. Scala 7,2x30 - 2 ⁷ / ₈ "x11 ³ / ₄ "		Elemento L Grip * 22,5x90 H. 4 8 ⁷ / ₈ "x35 ³ / ₈ " H. 1 ⁵ / ₈ "
				DX *	SX *	DX *	SX *	
Rovere Venice	AV68	AV7Z	AZFC	AV78	AV73	AV8G	AV8C	AV8K
Noce Hickory	AV7A	AV71	AZSH	AV8A	AV75	AV8I	AV8E	AV8M

* THESE PARTS ARE SUPPLIED TO ORDER | I PEZZI SONO DISPONIBILI SU ORDINAZIONE | Les pièces sont disponibles sur commande | Die Teile sind auf Bestellung lieferbar | Las piezas se hacen por encargo | Изготавливаются на заказ

THE DECORATION CAN ONLY BE LAID ON THE WALL | IL DECORO SI PUÒ POSARE SOLO A RIVESTIMENTO
 Décor uniquement mural | Das Dekor kann nur an der Wand verlegt werden | La decoración se puede colocar únicamente en paredes | Декор может быть уложен только на стену.



EXENCE

PORCELAIN TILES



Porcelain Tiles / Gres Porcellanato

COLOURED BODY PORCELAIN TILES - RECTIFIED MONOCALIBER
GRES PORCELLANATO COLORATO IN MASSA - RETTIFICATO MONOCALIBRO

Sizes	Thickness	Surface finish
18,5x150 cm - 7 ¹ / ₄ "x59"	± 9 mm	Matte R10 A+B
20x120 cm - 7 ⁷ / ₈ "x47 ¹ / ₄ "	± 9 mm	Matte R10 A+B
Outdoor Paving and Wet Areas		
		OUTDOOR PAVING p. 554
Sizes	Thickness	Surface finish
18,5x150 cm - 7 ¹ / ₄ "x59"	± 9 mm	Grip R11 A+B+C
30x120 cm - 11 ³ / ₄ "x47 ¹ / ₄ "	± 20 mm	Textured R11 A+B+C



COLOURED BODY PORCELAIN TILES | GRES PORCELLANATO COLORATO IN MASSA | Grés cérame coloré dans la masse | Durchgefärbtes Feinsteinzeug | Gres porcelánico coloreado en masa | Керамический гранит окрашенный в массе
RECTIFIED MONOCALIBER | RETTIFICATO MONOCALIBRO | Rectifié mono-calibre | Geschliffen einkalbrig | Rectificado monocalibr | Ретифицированный в одном калибре

EXENCE Porcelain Tiles / Gres Porcellanato

MATTE SURFACE / SUPERFICIE MATT



± 9 mm

18,5x150 cm 7¹/₄"x59"
AOUH Exence Vanilla 18,5x150
AL88 Exence Amber 18,5x150
AL87 Exence Almond 18,5x150

± 9 mm

20x120 cm 7⁷/₈"x47¹/₄"
AO47 Exence Vanilla 20x120
AO49 Exence Amber 20x120
AO48 Exence Almond 20x120

± 9 mm

18,5x150 cm 7¹/₄"x59"
AOUN Exence Vanilla Saw Cut 18,5x150
AOUN Exence Amber Saw Cut 18,5x150
AOUL Exence Almond Saw Cut 18,5x150

VANILLA



ALMOND



AMBER



VANILLA



ALMOND



AMBER



WOOD LOOK

WOOD LOOK



V2
SLIGHT
VARIATION



V2
SLIGHT
VARIATION

EXENCE Porcelain Tiles / Gres Porcellanato

GRIP SURFACE / SUPERFICIE GRIP

± 9 mm

18,5x150 cm 7^{1/4}"x59"

AOUK Exence Vanilla 18,5x150 Grip
AOUJ Exence Amber 18,5x150 Grip
AOUI Exence Almond 18,5x150 Grip



EXENCE Porcelain Tiles / Gres Porcellanato

OUTDOOR PAVING ± 20 mm / PAVIMENTI DA ESTERNO ± 20 mm

± 20 mm

30x120 cm 11^{3/4}"x47^{1/4}"

A2RY Exence Almond 30x120 20 mm
A2RZ Exence Amber 30x120 20 mm



VANILLA



ALMOND



AMBER



ALMOND



AMBER

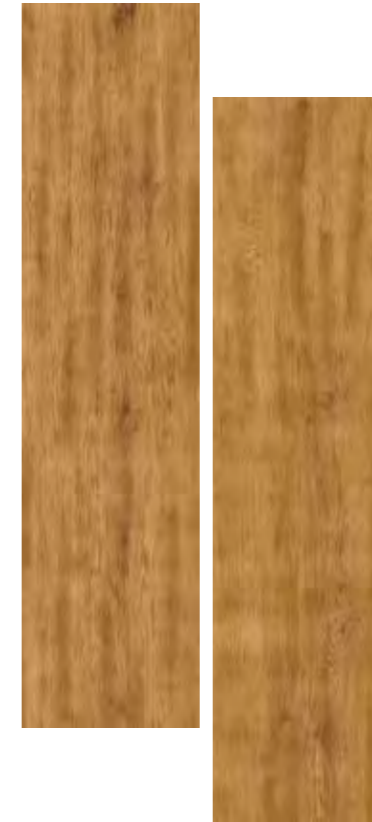

WOOD LOOK

WOOD LOOK



V2
SLIGHT
VARIATION



V2
SLIGHT
VARIATION

EXENCE Porcelain Tiles / Gres Porcellanato

DECOR RANGE / GAMMA DECORI

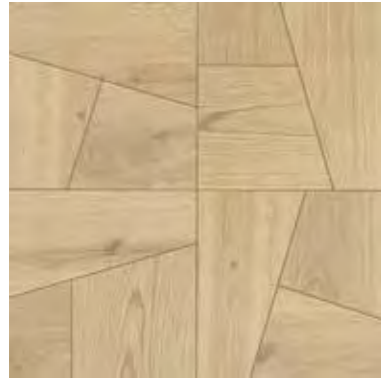

AOUU Exence
Vanilla Square
56,1x56,1 - 22"x22"

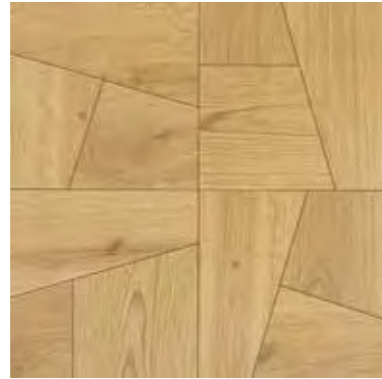

AOUV Exence
Almond Square
56,1x56,1 - 22"x22"



AOUW Exence
Amber Square
56,1x56,1 - 22"x22"

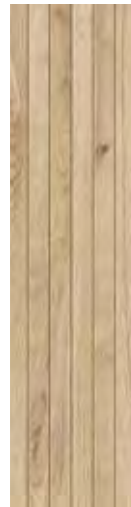

AOURL Exence
Vanilla Tatami
18,5x75 - 7 1/4"x29 1/2"



AOUS Exence
Almond Tatami
18,5x75 - 7 1/4"x29 1/2"



AOUT Exence
Amber Tatami
18,5x75 - 7 1/4"x29 1/2"



AOUG Exence
Vanilla Chevron
32,5x45 - 12 3/4"x17 3/4"



AMBJ Exence
Almond Chevron
32,5x45 - 12 3/4"x17 3/4"



AMBL Exence
Amber Chevron
32,5x45 - 12 3/4"x17 3/4"



WOOD LOOK

WOOD LOOK

TRIM TILES / PEZZI SPECIALI

p. 568

UPEC p. 595

		Battiscopa 7,2x150 - 2 7/8"x59"		Battiscopa 7,2x120 - 2 7/8"x47 1/4"		Scalino* 33x150 - 13"x59"		Scalino Angolare* 33x33 - 13"x13"		Battiscopa Sag. Scala 7,2x30 - 2 7/8"x11 1/4"		Elemento L Grip* 18,5x150 H. 4 - 7 1/4"x59"	
								SX*	DX*	SX*	DX*		
	Vanilla	AOUX	APC4	AOUY	AOU0	AOUZ	AOU2	AOU1	AOZI				
	Almond	AMA2	APC5	AMA6	AMBA	AMA8	AMBG	AMBE	AOZJ				
	Amber	AMA5	APC6	AMA7	AMBD	AMA9	AMBH	AMBF	AOZK				

* THESE PARTS ARE SUPPLIED TO ORDER | I PEZZI SONO DISPONIBILI SU ORDINAZIONE | Les pièces sont disponibles sur commande | Die Teile sind auf Bestellung lieferbar | Las piezas se hacen por encargo | Изготавливаются на заказ



HEARTWOOD

PORCELAIN TILES

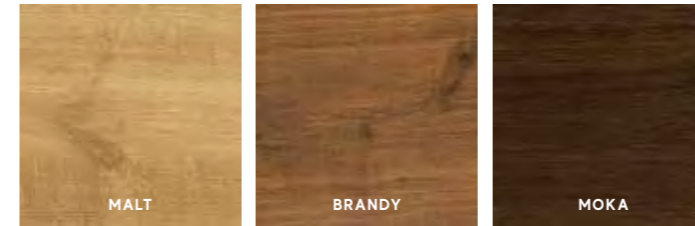

Porcelain Tiles / Gres Porcellanato

COLOURED BODY PORCELAIN TILES - RECTIFIED MONOCALIBER
GRES PORCELLANATO COLORATO IN MASSA - RETTIFICATO MONOCALIBRO

Sizes	Thickness	Surface finish
18,5x150 cm - 7 1/4"x59"	± 9 mm	Matte R9 A
20x120 cm - 7 7/8"x47 1/4"	± 9 mm	Matte R10 A+B



HEARTWOOD Porcelain Tiles / Gres Porcellanato

MATTE SURFACE / SUPERFICIE MATT



± 9 mm

18,5x150 cm 7¹/₄"x59"

AL68 Heartwood Malt 18,5x150
AL84 Heartwood Brandy 18,5x150
AL69 Heartwood Moka 18,5x150

MALT



BRANDY



MOKA



MALT



BRANDY



MOKA



± 9 mm

20x120 cm 7⁷/₈"x47¹/₄"

AL7E Heartwood Malt 20x120
AL85 Heartwood Brandy 20x120
AL7F Heartwood Moka 20x120



V3
MODERATE
VARIATION

MATTE SURFACE | SUPERFICIE MATT | Surface Mat | Matt oberfläche | Superficie Mate | Матовая поверхность



V3
MODERATE
VARIATION

481

HEARTWOOD Porcelain Tiles / Gres Porcellanato

DECOR RANGE / GAMMA DECORI



AOYG Heartwood Malt Mansion Weave
34,6x40 - 13⁷/₈"x15³/₄"



AOYH Heartwood Brandy Mansion Weave
34,6x40 - 13⁷/₈"x15³/₄"



AOYJ Heartwood Moka Mansion Weave
34,6x40 - 13⁷/₈"x15³/₄"



AO3K Heartwood Malt Marble Chevron
29,4x28,7 - 11⁵/₈"x11³/₈"
Malt + Marvel Black Atlantis



AO3L Heartwood Brandy Marble Chevron
29,4x28,7 - 11⁵/₈"x11³/₈"
Brandy + Marvel Black Atlantis



AOYI Heartwood Moka Marble Chevron
29,4x28,7 - 11⁵/₈"x11³/₈"
Moka + Marvel Black Atlantis



AOYD Heartwood Malt Tatami
18,5x75 - 7¹/₄"x29¹/₂"



AOYE Heartwood Brandy Tatami
18,5x75 - 7¹/₄"x29¹/₂"



AOYF Heartwood Moka Tatami
18,5x75 - 7¹/₄"x29¹/₂"







WOOD LOOK

WOOD LOOK

TRIM TILES / PEZZI SPECIALI

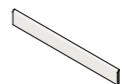
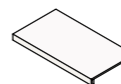
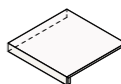
p. 568

LUPEC p. 595

							
		Battiscopa 7,2x150 - 2 ⁷ / ₈ "x59"	Battiscopa 7,2x120 - 2 ⁷ / ₈ "x47 ¹ / ₄ "	Scalino * 33x150 - 13"x59"	Scalino Angolare * 33x33 - 13"x13"	Battiscopa Sag. Scala 7,2x30 - 2 ⁷ / ₈ "x11 ¹ / ₄ "	
				SX *	DX *	SX *	DX *
 Malt	AMAH	AMAE	AMAK	AMAR	AMAN	AMAZ	AMAW
 Brandy	AMAI	AMAF	AMAL	AMAU	AMAO	AMAØ	AMAX
 Moka	AMAJ	AMAG	AMAM	AMAV	AMAQ	AMA1	AMAY

* THESE PARTS ARE SUPPLIED TO ORDER | I PEZZI SONO DISPONIBILI SU ORDINAZIONE | Les pièces sont disponibles sur commande | Die Teile sind auf Bestellung lieferbar | Las piezas se hacen por encargo | Изготавливаются на заказ



NASH
PORCELAIN TILES



Porcelain Tiles / Gres Porcellanato

COLOURED BODY PORCELAIN TILES - RECTIFIED MONOCALIBER
GRES PORCELLANATO COLORATO IN MASSA - RETTIFICATO MONOCALIBRO

Sizes	Thickness	Surface finish
20x120 cm - 7 ⁷ / ₈ "x47 ¹ / ₄ "	± 9 mm	Matte R10 A+B
7,5x60 cm - 3"x23 ⁵ / ₈ "	± 8,5 mm	Matte R10 A
► NON RECTIFIED - NON RETTIFICATO		

Outdoor Paving and Wet Areas OUTDOOR PAVING p. 554

Sizes	Thickness	Surface finish
20x120 cm - 7 ⁷ / ₈ "x47 ¹ / ₄ "	± 9 mm	Grip R11 A+B+C



COLOURED BODY PORCELAIN TILES | GRES PORCELLANATO COLORATO IN MASSA | Grés cérame coloré dans la masse | Durchgefärbtes Feinsteinzeug | Gres porcelánico coloreado en masa | Керамический гранит окрашенный в массе
RECTIFIED MONOCALIBER | RETTIFICATO MONOCALIBRO | Rectifié mono-calibre | Geschliffen einkalibrig | Rettificato monocalibre | Ретифицированный в одном калибре
NON RECTIFIED | NON RETTIFICATO | Non rectifié | Nicht rektifiziert | No rectificada | Неретифицированные

NASH Porcelain Tiles / Gres Porcellanato

MATTE SURFACE / SUPERFICIE MATT



± 9 mm

20x120 cm 7^{7/8}"x47^{1/4}"
 AN2I Nash White Wood 20x120
 AN2J Nash Greige 20x120
 AN2K Nash Gray Wood 20x120
 AN2L Nash Dark Oak 20x120
 AN2M Nash Light Brown 20x120



NASH Porcelain Tiles / Gres Porcellanato

GRIP SURFACE / SUPERFICIE GRIP



± 9 mm

20x120 cm 7^{7/8}"x47^{1/4}"
 AKCQ Nash White Wood 20x120 Grip
 AKCR Nash Greige 20x120 Grip
 AKCT Nash Gray Wood 20x120 Grip
 AKCU Nash Dark Oak 20x120 Grip
 AKCV Nash Light Brown 20x120 Grip



NON RECTIFIED / NON RETTIFICATO



± 8,5 mm

7,5x60 cm 3"x23^{3/8}"
 AN2N Nash White Wood 7,5x60
 AN2O Nash Greige 7,5x60
 AN2Q Nash Gray Wood 7,5x60



**V3
 MODERATE
 VARIATION**

GRIP SURFACE / SUPERFICIE GRIP | Surface grip | Grip oberfläche | Superficie Grip | Grip поверхность



**V3
 MODERATE
 VARIATION**

NASH Porcelain Tiles / Gres Porcellanato

DECOR RANGE / GAMMA DECORI



AONW Nash White Wood Tatami
18,5x74,4 - 7¹/₄"x29³/₈"



AONX Nash Greige Tatami
18,5x74,4 - 7¹/₄"x29³/₈"



AONY Nash Gray Wood Tatami
18,5x74,4 - 7¹/₄"x29³/₈"



2,85x74,4 cm
1¹/₈"x29³/₈"



AONZ Nash Dark Oak Tatami
18,5x74,4 - 7¹/₄"x29³/₈"



AONØ Nash Light Brown Tatami
18,5x74,4 - 7¹/₄"x29³/₈"



AN9R Nash White Wood Chevron
32,5x45 - 12³/₄"x17³/₄"



AN9S Nash Greige Chevron
32,5x45 - 12³/₄"x17³/₄"



AN9T Nash Gray Wood Chevron
32,5x45 - 12³/₄"x17³/₄"

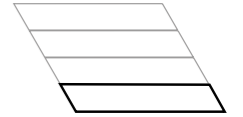

7,9x44,6 cm
3¹/₈"x17³/₄"



AN9U Nash Dark Oak Chevron
32,5x45 - 12³/₄"x17³/₄"



AN9V Nash Light Brown Chevron
32,5x45 - 12³/₄"x17³/₄"

WOOD LOOK

WOOD LOOK



TRIM TILES / PEZZI SPECIALI

p. 568

UPEC p. 595

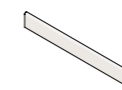

Battiscopa
7,2x120
2⁷/₈"x47¹/₄"



Battiscopa Sag. Scala
7,2x30 - 2⁷/₈"x11³/₄"

		DX *	SX *
White Wood	AN30	AN29	AN3F
Greige	AN3P	AN3A	AN3G
Gray Wood	AN3Q	AN3C	AN3H
Dark Oak	AN3S	AN3D	AN3I
Light Brown	AN3T	AN3E	AN3J

* THESE PARTS ARE SUPPLIED TO ORDER | I PEZZI SONO DISPONIBILI SU ORDINAZIONE | Les pièces sont disponibles sur commande | Die Teile sind auf Bestellung lieferbar | Las piezas se hacen por encargo | Изготавливаются на заказ



NID

PORCELAIN TILES

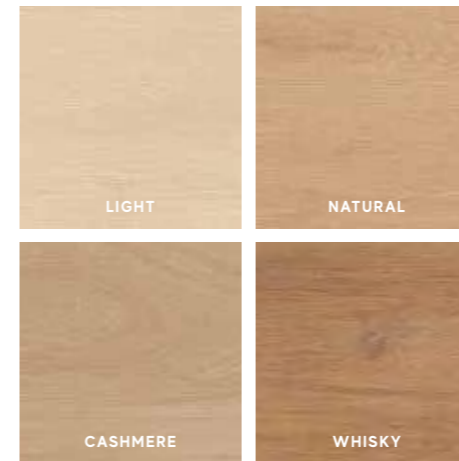

Porcelain Tiles / Gres Porcellanato

COLOURED BODY PORCELAIN TILES - RECTIFIED MONOCALIBER
GRES PORCELLANATO COLORATO IN MASSA - RETTIFICATO MONOCALIBRO

Sizes	Thickness	Surface finish
25x150 cm - 9 ⁷ / ₈ "x59"	± 9 mm	Matte R10 A
18,5x150 cm - 7 ¹ / ₄ "x59"	± 9 mm	Matte R10 A
15x90 cm - 5 ⁷ / ₈ "x35 ³ / ₈ "	± 9 mm	Matte R10 A



NID Porcelain Tiles / Gres Porcellanato

MATTE SURFACE / SUPERFICIE MATT

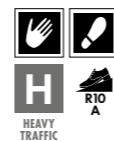

± 9 mm

25x150 cm 9^{7/8}"x59"

AAL5 NID Light 25x150
AKSU NID Cashmere 25x150
AAL6 NID Natural 25x150
AAL7 NID Whisky 25x150

LIGHT



NATURAL



CASHMERE



WHISKY



± 9 mm

18,5x150 cm 7^{1/4}"x59"

AANK NID Light 18,5x150
AANI NID Cashmere 18,5x150
AANJ NID Natural 18,5x150
AANL NID Whisky 18,5x150

LIGHT



NATURAL



CASHMERE



WHISKY



± 9 mm

15x90 cm 5^{7/8}"x35^{3/8}"

D230 NID Light 15x90
D233 NID Cashmere 15x90
D231 NID Natural 15x90
D232 NID Whisky 15x90

WOOD LOOK

WOOD LOOK



V2
SLIGHT
VARIATION



V2
SLIGHT
VARIATION

NID Porcelain Tiles / Gres Porcellanato

DECOR RANGE / GAMMA DECORI



AAOA NID Light Mosaico Esagono
30x35 - 11³/₄"x13³/₄"



AAOD NID Cashmere Mosaico Esagono
30x35 - 11³/₄"x13³/₄"



AAOB NID Natural Mosaico Esagono
30x35 - 11³/₄"x13³/₄"



AAOC NID Whisky Mosaico Esagono
30x35 - 11³/₄"x13³/₄"



AAN6 NID Light Herringbone
36,2x41,2 - 14¹/₈"x16¹/₈"



AAN9 NID Cashmere Herringbone
36,2x41,2 - 14¹/₈"x16¹/₈"



AAN7 NID Natural Herringbone
36,2x41,2 - 14¹/₈"x16¹/₈"



AAN8 NID Whisky Herringbone
36,2x41,2 - 14¹/₈"x16¹/₈"



AAOO NID Light Mosaico Intreccio
35x35 - 13³/₄"x13³/₄"



AAOR NID Cashmere Mosaico Intreccio
35x35 - 13³/₄"x13³/₄"



AAOP NID Natural Mosaico Intreccio
35x35 - 13³/₄"x13³/₄"



AAOQ NID Whisky Mosaico Intreccio
35x35 - 13³/₄"x13³/₄"



AAOF NID Natural Cassettone
46,2x46,2 - 18¹/₄"x18¹/₄"
NID NATURAL + ARKSHADE GREY



AAOJ NID Natural Mosaico Domino
29,7x30,6 - 11⁵/₈"x12"
NID NATURAL + ARKSHADE GREY

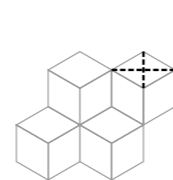
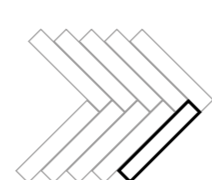
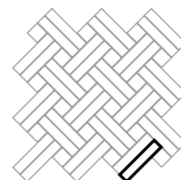
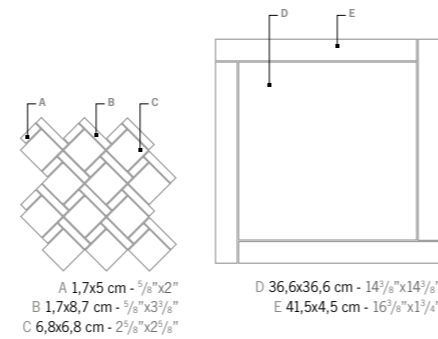

AANX NID Light Tatami
22,5x90 - 8⁷/₈"x35³/₈"



AAN1 NID Cashmere Tatami
22,5x90 - 8⁷/₈"x35³/₈"



AANY NID Natural Tatami
22,5x90 - 8⁷/₈"x35³/₈"



AANØ NID Whisky Tatami
22,5x90 - 8⁷/₈"x35³/₈"

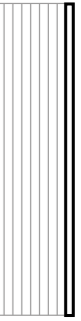

2,3x90 cm
7/8"x35³/₈"



AAN2 NID Light Chevron
11,5x67 - 4¹/₂"x26³/₈"



AAN3 NID Natural Chevron
11,5x67 - 4¹/₂"x26³/₈"



AAN5 NID Cashmere Chevron
11,5x67 - 4¹/₂"x26³/₈"



AAN4 NID Whisky Chevron
11,5x67 - 4¹/₂"x26³/₈"

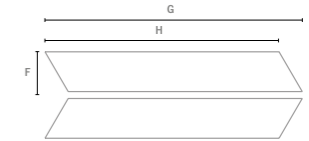

F 11,5 cm - 4¹/₂"
G 73,6 cm - 29"
H 67 cm - 26³/₈"

TRIM TILES / PEZZI SPECIALI

p. 568

UPEC p. 595

	Battiscopa 7,2x90 2 ⁷ / ₈ "x35 ³ / ₈ "	Scalino * 33x150 13"x59"	Scalino Angolare 33x33 - 13"x13"		Battiscopa Sag. Scala 7,2x30 - 2 ⁷ / ₈ "x11 ³ / ₄ "	
			DX *	SX *	DX *	SX *
Light	A8KF	A8KJ	A8KN	A8KR	A8KV	A8KZ
Natural	A8KG	A8KK	A8KO	A8KS	A8KW	A8KØ
Whisky	A8KH	A8KL	A8KP	A8KT	A8KX	A8K1
Cashmere	A8KI	A8KM	A8KQ	A8KU	A8KY	A8K2

* THESE PARTS ARE SUPPLIED TO ORDER | I PEZZI SONO DISPONIBILI SU ORDINAZIONE | Les pièces sont disponibles sur commande | Die Teile sind auf Bestellung lieferbar | Las piezas se hacen por encargo | Изготавливаются на заказ

GRANIGLIATI Porcelain Tiles / Gres Porcellanato

TECHNICAL PORCELAIN TILES
GRES PORCELLANATO TECNICO

MATTE SURFACE / SUPERFICIE MATT

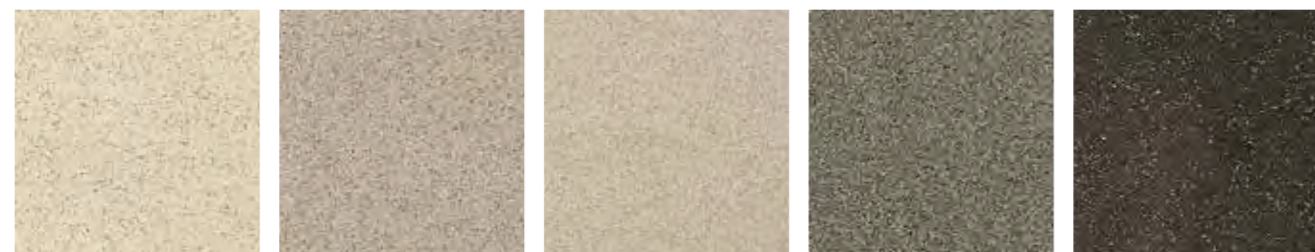

3y0P Bianco Lasa 30 Matt 30x30 - 11³/₄"x11³/₄"
 3y0Q Libeccio 30 Matt 30x30 - 11³/₄"x11³/₄"
 3y04 Luserna 30 Matt 30x30 - 11³/₄"x11³/₄"
 3y03 Serizzo 30 Matt 30x30 - 11³/₄"x11³/₄"
 3y0L Grafite 30 Matt 30x30 - 11³/₄"x11³/₄"

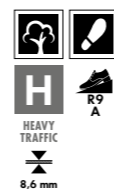

AY4J Bianco Lasa 20 Matt 20x20 - 7⁷/₈"x7⁷/₈"
 AY4K Luserna 20 Matt 20x20 - 7⁷/₈"x7⁷/₈"
 AY4I Serizzo 20 Matt 20x20 - 7⁷/₈"x7⁷/₈"



AY40 Bianco Lasa 20 Sp. 12 mm. 20x20 - 7⁷/₈"x7⁷/₈"
 AY4P Serizzo 20 Sp. 12 mm. 20x20 - 7⁷/₈"x7⁷/₈"



TEXTURED SURFACE / SUPERFICIE STRUTTURATO



3ySP Bianco Lasa 30 Strutturato 30x30 - 11³/₄"x11³/₄"
 3yS4 Luserna 30 Strutturato 30x30 - 11³/₄"x11³/₄"
 3yS3 Serizzo 30 Strutturato 30x30 - 11³/₄"x11³/₄"



AY4L Bianco Lasa 20 Strutturato 20x20 - 7⁷/₈"x7⁷/₈"
 AY4M Serizzo 20 Strutturato 20x20 - 7⁷/₈"x7⁷/₈"



















AT4S Bianco Lasa 20 Antidrucciolo P. Diam. 20x20 - 7⁷/₈"x7⁷/₈"



TRIM TILES / PEZZI SPECIALI

p. 568

UPEC p. 595

						
	Sguscia C.B. 10x20 - 3 ⁷ / ₈ "x7 ⁷ / ₈ "	Sguscia Ang. Est. C.B. H. 10 - 3 ⁷ / ₈ "	Sguscia Ang. Int. C.B. H. 10 - 3 ⁷ / ₈ "	Racc. a Pavimento 10x20 - 3 ⁷ / ₈ "x7 ⁷ / ₈ "	Angolo Esterno H. 10 - 3 ⁷ / ₈ "	Angolo Interno H. 10 - 3 ⁷ / ₈ "
 Bianco Lasa	1WBP	8YEP	8YIP	1W0P	8WEP	8WAP
 Luserna	1WB4	8YE4	8YI4	1W04	8WS4	8WA4
 Serizzo	1WB3	8YE3	8YI3	1W03	8WS3	8WA3
						
	Battiscopa Matt 10x30 - 3 ⁷ / ₈ "x11 ³ / ₄ "	Gradino Matt 30x30 - 11 ³ / ₄ "x11 ³ / ₄ "	Gradino Strutturato 30x30 - 11 ³ / ₄ "x11 ³ / ₄ "			
 Bianco Lasa	6W0P	3yGP	3yRP			
 Grafite	6W0L	3yGL	-			
 Libeccio	6W0Q	3yGQ	-			
 Luserna	6W04	3yG4	3yR4			
 Serizzo	6W03	3yG3	3yR3			

Some items of the Granigliati collection are manufactured in France.
Alcuni articoli della collezione Granigliati sono realizzati in Francia.

TECHNICAL PORCELAIN TILES | GRES PORCELLANATO TECNICO | Grés cérame technique | Technisches Feinsteinzeug | Gres porcelánico técnico | Технический керамический гранит
 MATTE SURFACE | SUPERFICIE MATT | Surface Mat | Matt oberfläche | Superficie Mate | Матовая поверхность

V1
UNIFORM
APPEARANCE



TECHNICAL PORCELAIN TILES | GRES PORCELLANATO TECNICO | Grés cérame technique | Technisches Feinsteinzeug | Gres porcelánico técnico | Технический керамический гранит
 MATTE SURFACE | SUPERFICIE MATT | Surface Mat | Matt oberfläche | Superficie Mate | Матовая поверхность

XL

LARGE SIZES | PORCELAIN TILES

COLOURED BODY PORCELAIN TILES - RECTIFIED MONOCALIBER
GRES PORCELLANATO COLORATO IN MASSA - RETTIFICATO MONOCALIBRO

 atlas concorde



RECTIFIED / RETTIFICATO

120x120 cm - 47¹/₄"x47¹/₄"
± 6, 9 mm

120x240 cm - 47¹/₄"x94¹/₂"
± 9 mm

120x278 cm - 47¹/₄"x109¹/₂"
± 6 mm

160x160 cm - 63"x63"
± 6 mm

160x320 cm - 63"x126"
± 6 mm



GLAZED PORCELAIN TILES
GRES PORCELLANATO SMALTATO

120x278 cm - 47¹/₄"x109¹/₂"
± 6 mm

 atlasPLAN



NON-RECTIFIED / NON RETTIFICATO

162x324 cm - 63³/₄"x127¹/₂"
± 6, 12, 20 mm

atlas concorde

XL Large Sizes

Porcelain Tiles / Gres Porcellanato

MARBLE LOOK



More choices for 162x324 cm / Non-Rectified Single Slab

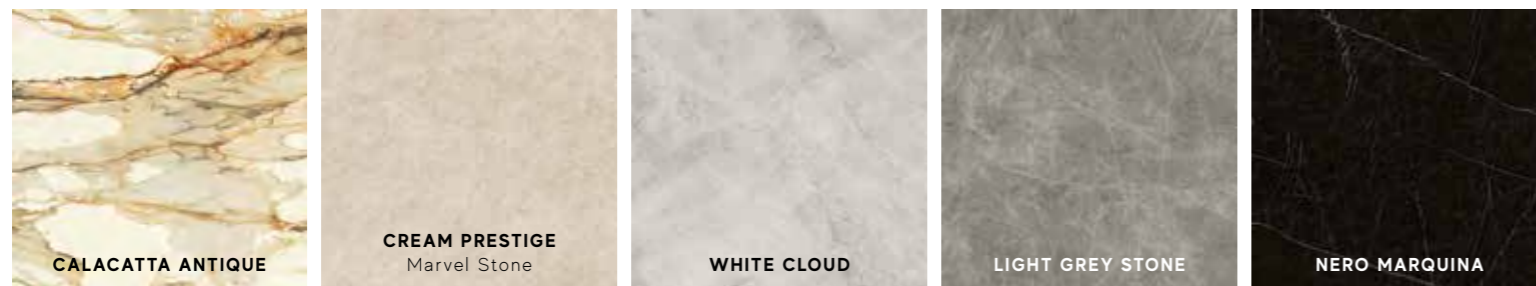

METAL LOOK

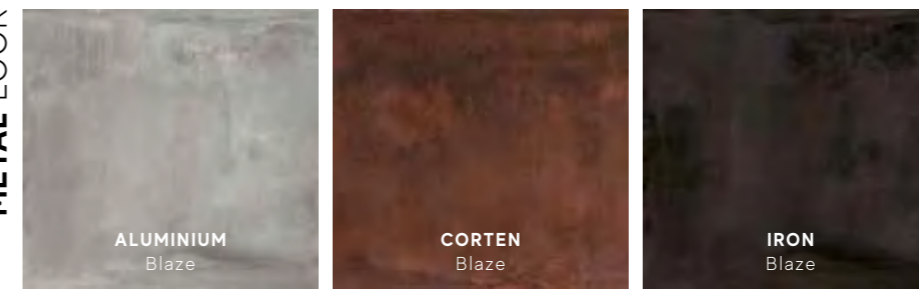

CONCRETE LOOK



LARGE SIZES

LARGE SIZES

XL Large Sizes

Porcelain Tiles / Gres Porcellanato

STONE LOOK



COLOR & DECOR

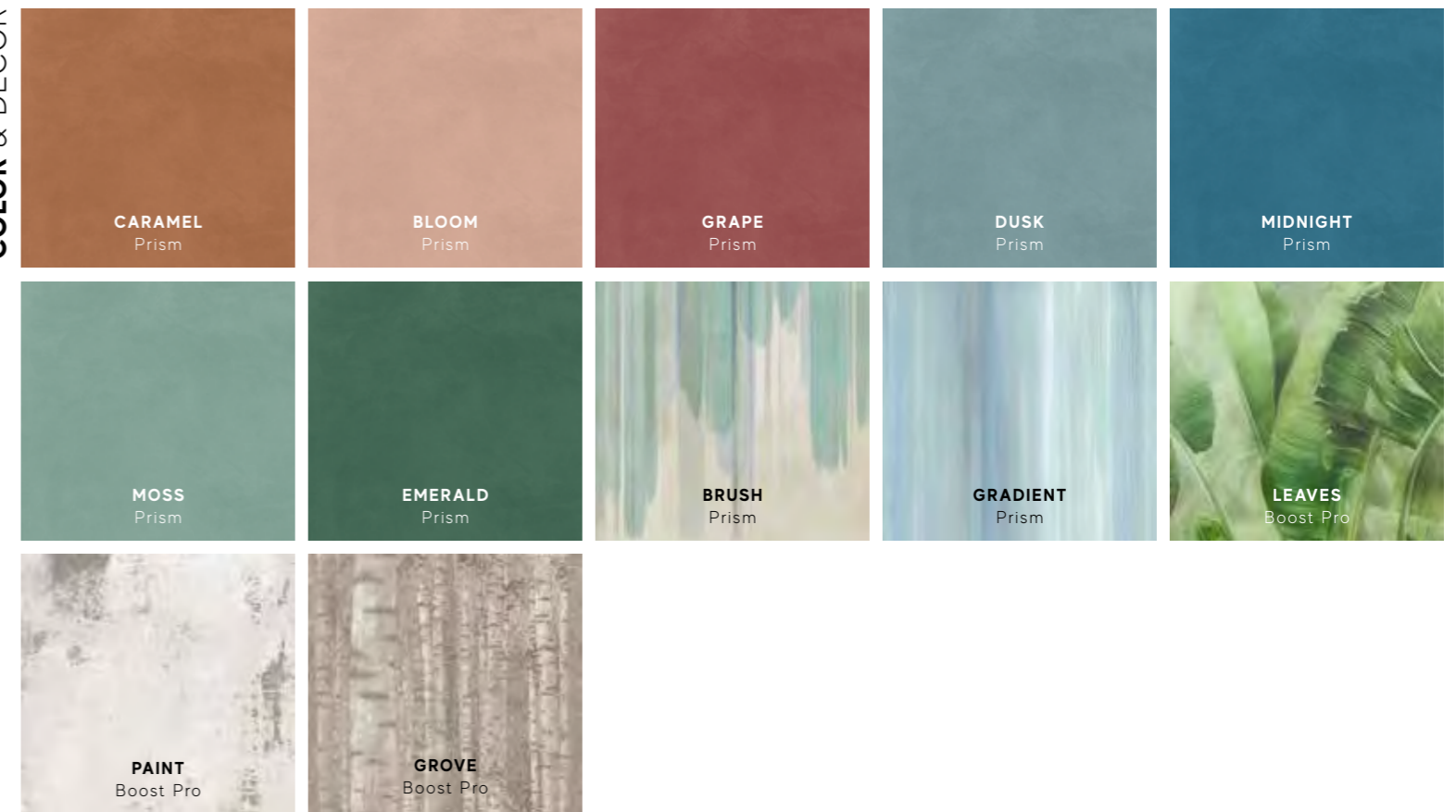

More choices for 162x324 cm / Non-Rectified Single Slab

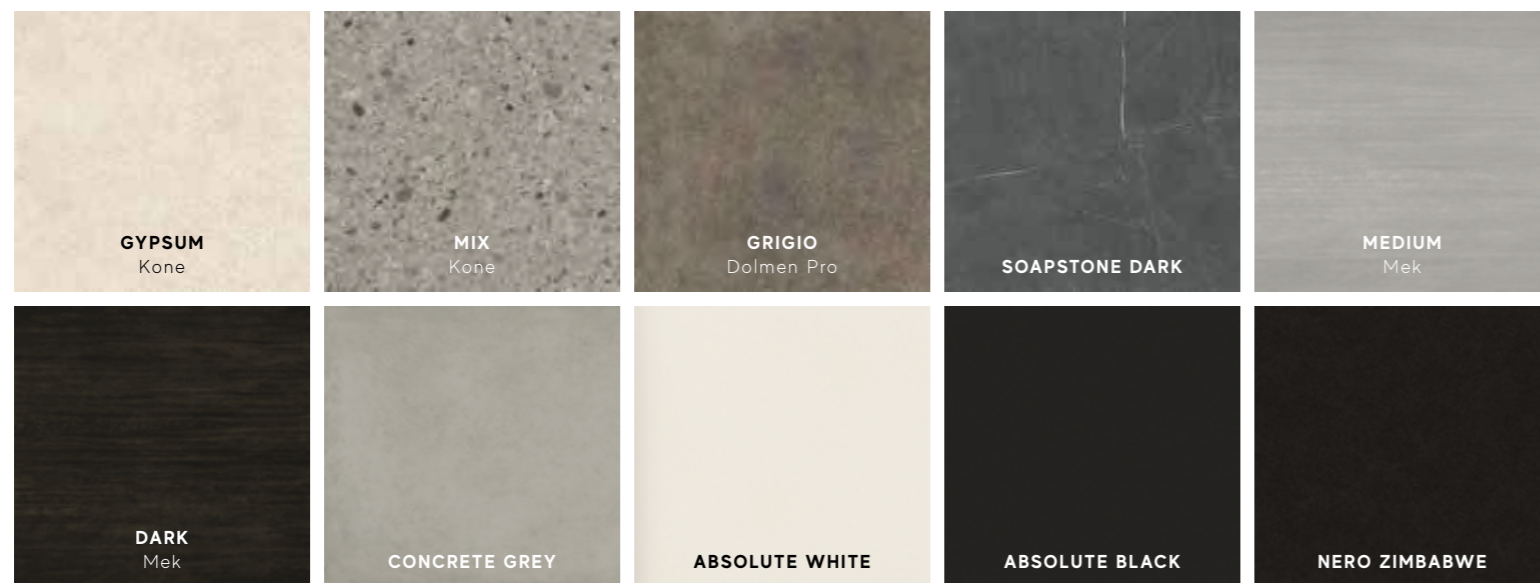

LARGE SIZES

LARGE SIZES

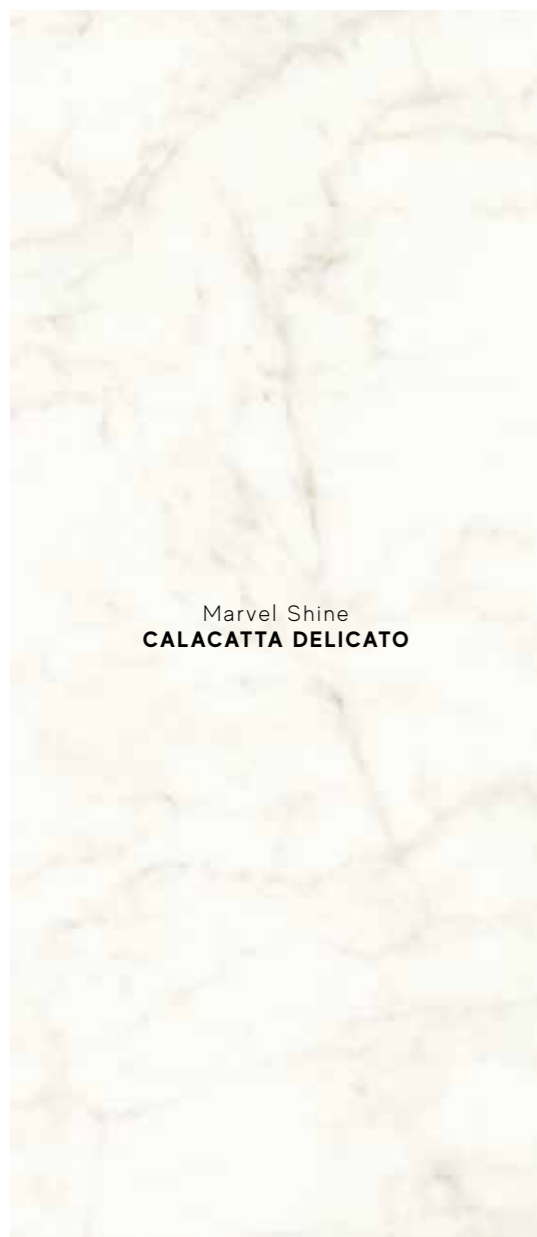

Marvel Shine
CALACATTA DELICATO

Sizes	Thickness	Surface finish
120x120 cm - 47 ¹ / ₄ "x47 ¹ / ₄ "	± 9 mm	Polished Matte
120x240 cm - 47 ¹ / ₄ "x94 ¹ / ₂ "	± 9 mm	Polished
120x278 cm - 47 ¹ / ₄ "x109 ¹ / ₂ "	± 6 mm	Polished

- ▼
- A4Q4 Marvel Calacatta Delicato 120x120 Matt
- A4Q8 Marvel Calacatta Delicato 120x120 Lappato
- A4RH Marvel Calacatta Delicato 120x240 Lappato
- A4OY Marvel Calacatta Delicato 120x278 Lappato

VEINS CONTINUITY ▲■ (SEE PAGE 553)

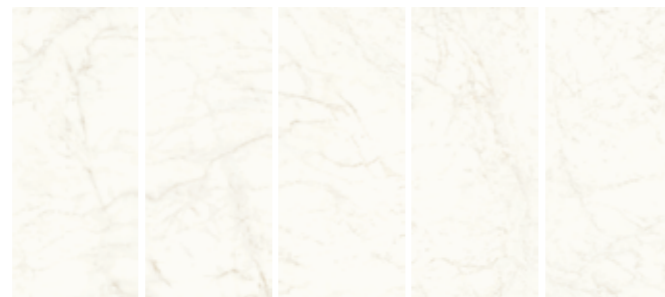

120x278 cm - 47¹/₄"x109¹/₂" ± 6 mm Polished

atlasPLAN SINGLE SLAB NON RECTIFIED
162x324 cm - 63³/₄"x127¹/₂"



162x324 cm - 63³/₄"x127¹/₂" ± 12 mm Silk
NON-RECTIFIED

- ▼
- A4T3 Calacatta Delicato Silk - 12mm ST *

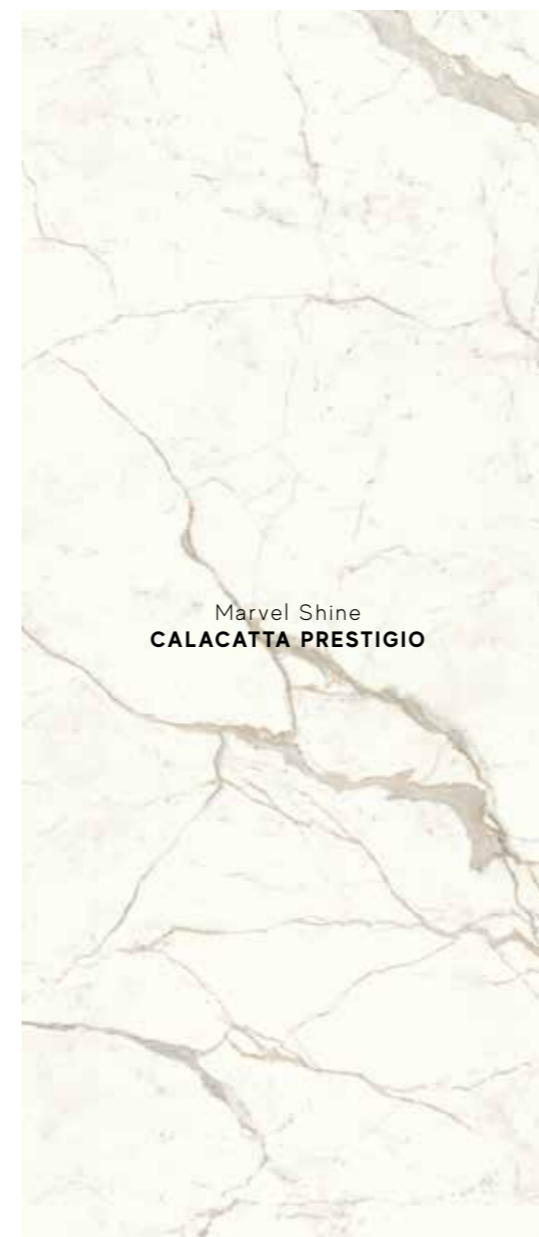

Marvel Shine
CALACATTA PRESTIGIO

Sizes	Thickness	Surface finish
120x120 cm - 47 ¹ / ₄ "x47 ¹ / ₄ "	± 9 mm	Polished Matte
120x240 cm - 47 ¹ / ₄ "x94 ¹ / ₂ "	± 9 mm	Polished
120x278 cm - 47 ¹ / ₄ "x109 ¹ / ₂ "	± 6 mm	Polished Silk
160x160 cm - 63"x63"	± 6 mm	Polished
160x320 cm - 63"x126"	± 6 mm	Polished

- ▼
- A4Q5 Marvel Calacatta Prestigio 120x120 Matt
- A4Q9 Marvel Calacatta Prestigio 120x120 Lappato
- A4RI Marvel Calacatta Prestigio 120x240 Lappato
- A4OZ Marvel Calacatta Prestigio 120x278 Lappato
- A4O6 Marvel Calacatta Prestigio 120x278 Silk
- A4RP Marvel Calacatta Prestigio 160x160 Lappato
- A4RR Marvel Calacatta Prestigio 160x320 Lappato

BOOKMATCH A BOOKMATCH B



120x278 cm - 47¹/₄"x109¹/₂" ± 6 mm Polished

- ▼
- A4O2 Marvel Calacatta Prestigio 120x278 Bookm A Lp
- A4O3 Marvel Calacatta Prestigio 120x278 Bookm B Lp

VEINS CONTINUITY ▲ (SEE PAGE 553)



160x320 cm - 63"x126" ± 6 mm Polished
120x278 cm - 47¹/₄"x109¹/₂" ± 6 mm Polished | Silk

- ▼
- A6E0 Marvel Calacatta Prestigio 120x278 Lappato Kit Endless ■ (see page 553)
- A6ER Marvel Calacatta Prestigio 120x278 Silk Kit Endless

atlasPLAN SINGLE SLAB NON RECTIFIED
162x324 cm - 63³/₄"x127¹/₂"

CALACATTA PRESTIGIO CALACATTA PRESTIGIO BOOKMATCH



162x324 cm - 63³/₄"x127¹/₂" ± 12 mm Silk
NON-RECTIFIED

- ▼
- A4T0 Calacatta Prestigio Silk - 12 mm ST *
- A4T1 Calacatta Prestigio Bookmatch Silk - 12 mm ST *



BOOKMATCH A **BOOKMATCH B**

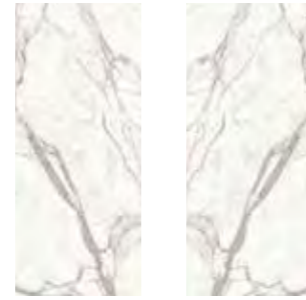

120x278 cm - 47 1/4"x109 1/2" ± 6 mm Polished



A404 Marvel Statuario Supremo 120x278 Bookm A Lp
A405 Marvel Statuario Supremo 120x278 Bookm B Lp

VEINS CONTINUITY ▲ (SEE PAGE 553)

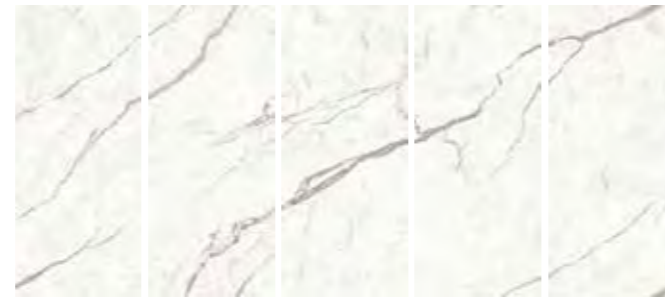

160x320 cm - 63"x126" ± 6 mm Polished
120x278 cm - 47 1/4"x109 1/2" ± 6 mm Polished | Silk



A6EP Marvel Statuario Supremo 120x278 Lappato Kit Endless ■ (see page 553)
A6ES Marvel Statuario Supremo 120x278 Silk Kit Endless

atlasPLAN SINGLE SLAB NON RECTIFIED
162x324 cm - 63 3/4"x127 1/2"

STATUARIO SUPREMO **STATUARIO SUPREMO BOOKMATCH** **STATUARIO SUPREMO NATURA VEIN**



162x324 cm - 63 3/4"x127 1/2" ± 12 mm Silk | Satin
162x324 cm - 63 3/4"x127 1/2" ± 20 mm Polished | Silk
NON-RECTIFIED



A4Q6 Marvel Statuario Supremo 120x120 Matt
A4RA Marvel Statuario Supremo 120x120 Lappato
A4RJ Marvel Statuario Supremo 120x240 Lappato
A400 Marvel Statuario Supremo 120x278 Lappato
A407 Marvel Statuario Supremo 120x278 Silk
A4RQ Marvel Statuario Supremo 160x160 Lappato
A4RS Marvel Statuario Supremo 160x320 Lappato

A4I3 Statuario Supremo Satin - 12 mm ST *
A4TX Statuario Supremo Silk - 12 mm ST *
A4I5 Statuario Supremo Bookmatch Satin - 12 mm ST *
A4TY Statuario Supremo Bookmatch Silk - 12 mm ST *
A3VR Statuario Supremo Polished NATURA VEIN - 20mm
A3VQ Statuario Supremo Silk NATURA VEIN - 20mm



BOOKMATCH A **BOOKMATCH B**



120x278 cm - 47 1/4"x109 1/2" ± 6 mm Polished



A0TJ Marvel Calacatta Extra 120x278 Bookm A Lp
A0TK Marvel Calacatta Extra 120x278 Bookm B Lp

ENDLESS ▲ (SEE PAGE 553)

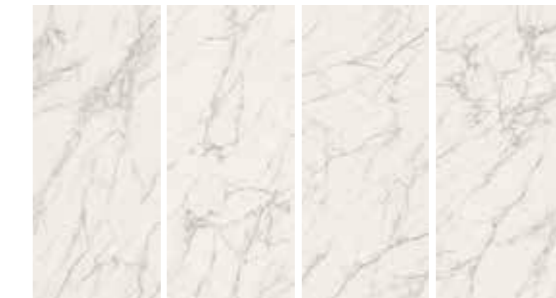

120x278 cm - 47 1/4"x109 1/2" ± 6 mm Polished



A0UB Marvel Calacatta Extra 120x278 Endless Lp ■ (see page 553)
A6DU Marvel Calacatta Extra 120x278 Kit Endless Lp

atlasPLAN SINGLE SLAB NON RECTIFIED
162x324 cm - 63 3/4"x127 1/2"

CALACATTA EXTRA A **CALACATTA EXTRA A BOOKMATCH** **CALACATTA EXTRA A NATURA VEIN** **CALACATTA EXTRA B**

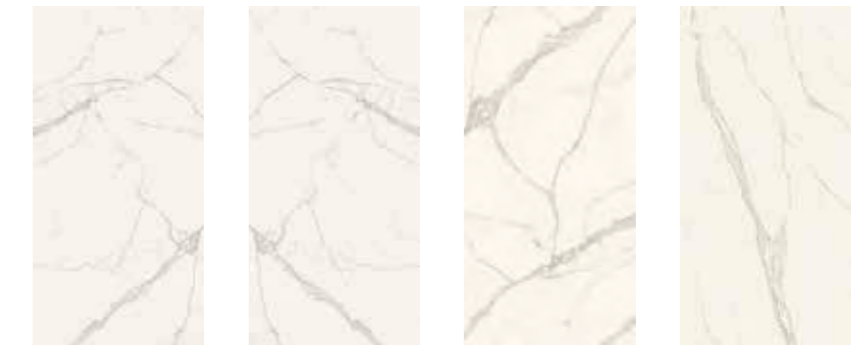

162x324 cm - 63 3/4"x127 1/2" ± 6-12-20 mm Polished | Silk
NON-RECTIFIED



A20Y Marvel Calacatta Extra 120x120 Matt
AY2R Marvel Calacatta Extra 120x120 Lappato
AY2N Marvel Calacatta Extra 120x240 Lappato
A0BT Marvel Calacatta Extra 120x278 Matt
A0BM Marvel Calacatta Extra 120x278 Lappato
A0S4 Marvel Calacatta Extra 160x160RT Lappato
A0S1 Marvel Calacatta Extra 160x160RT Lappato
A0S5 Marvel Calacatta Extra 160x320RT Lappato
A0SU Marvel Calacatta Extra 160x320RT Lappato

AN1J Calacatta Extra A Polished - 6mm ST *
AN1G Calacatta Extra A Silk - 6mm ST *
AAVD Calacatta Extra A Polished - 12mm ST *
AA2T Calacatta Extra A Silk - 12mm ST *
AN1W Calacatta Extra A Polished - 20mm
A0YC Calacatta Extra A Silk - 20mm
AOAZ Calacatta Extra A Bookmatch Polished - 6mm ST *
AOAW Calacatta Extra A Bookmatch Silk - 6mm ST *
AA2X Calacatta Extra A Bookmatch Polished - 12mm ST *
AMJV Calacatta Extra A Bookmatch Silk - 12mm ST *
A0YD Calacatta Extra A Bookmatch Silk - 20mm
A3VS Calacatta Extra A Bookmatch Polished - 20mm

A00I Calacatta Extra B Polished - 6mm ST *
A00K Calacatta Extra B Silk - 6mm ST *
AAVF Calacatta Extra B Polished - 12mm ST *
AA3G Calacatta Extra B Silk - 12mm ST *
A00E Calacatta Extra B Polished - 20mm
A3M3 Calacatta Extra A Polished NATURA VEIN - 20mm
A28Q Calacatta Extra A Silk NATURA VEIN - 20mm

XL Large Sizes

Porcelain Tiles / Gres Porcellanato

MARBLE LOOK



Marvel Dream
BIANCO FANTASTICO

Sizes	Thickness	Surface finish
120x120 cm - 47 ¹ / ₄ "x47 ¹ / ₄ "	± 9 mm	Polished I Matte
120x240 cm - 47 ¹ / ₄ "x94 ¹ / ₂ "	± 9 mm	Polished
120x278 cm - 47 ¹ / ₄ "x109 ¹ / ₂ "	± 6 mm	Polished I Matte

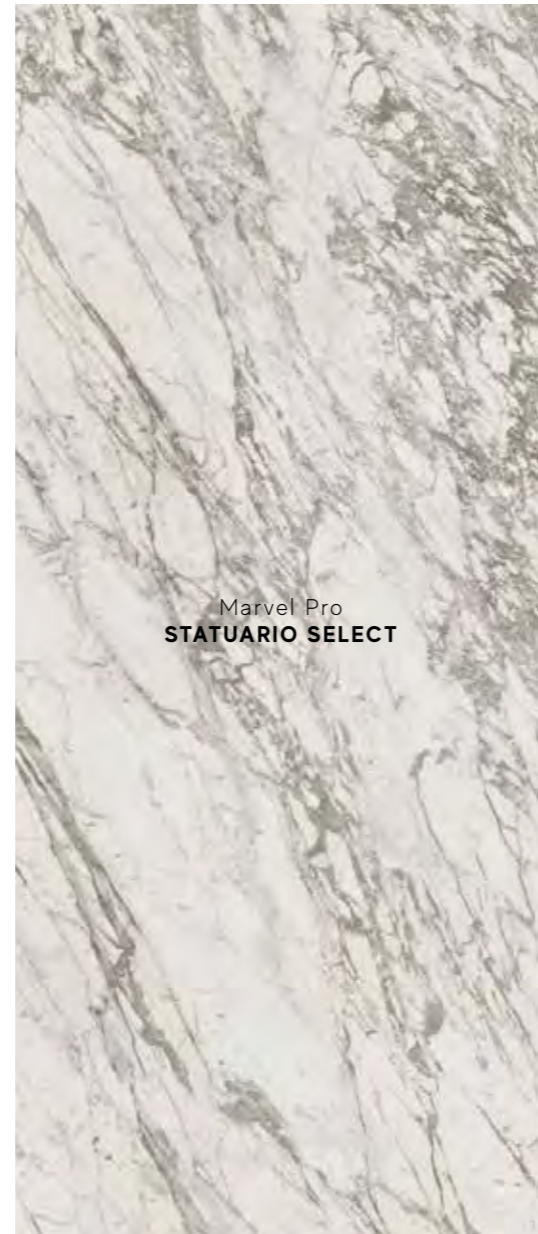

Marvel Pro
STATUARIO SELECT

Sizes	Thickness	Surface finish
120x120 cm - 47 ¹ / ₄ "x47 ¹ / ₄ "	± 9 mm	Polished
120x240 cm - 47 ¹ / ₄ "x94 ¹ / ₂ "	± 9 mm	Polished
120x278 cm - 47 ¹ / ₄ "x109 ¹ / ₂ "	± 6 mm	Polished



Marvel Stone
CARRARA PURE

Sizes	Thickness	Surface finish
120x120 cm - 47 ¹ / ₄ "x47 ¹ / ₄ "	± 9 mm	Polished I Matte
120x240 cm - 47 ¹ / ₄ "x94 ¹ / ₂ "	± 9 mm	Polished
120x278 cm - 47 ¹ / ₄ "x109 ¹ / ₂ "	± 6 mm	Polished I Matte



Marvel Stone
BIANCO DOLOMITE

Sizes	Thickness	Surface finish
120x120 cm - 47 ¹ / ₄ "x47 ¹ / ₄ "	± 9 mm	Polished I Matte
120x240 cm - 47 ¹ / ₄ "x94 ¹ / ₂ "	± 9 mm	Polished
120x278 cm - 47 ¹ / ₄ "x109 ¹ / ₂ "	± 6 mm	Polished I Matte
160x160 cm - 63"x63"	± 6 mm	Polished
160x320 cm - 63"x126"	± 6 mm	Polished
162x324 cm - 63 ³ / ₄ "x127 ¹ / ₂ "	± 12 mm	Polished

> NON-RECTIFIED

- ▼
- A203 Marvel Bianco Fantastico 120x120 Matt
- AL7N Marvel Bianco Fantastico 120x120 Lappato
- A03P Marvel Bianco Fantastico 120x240 Lappato
- A2RR Marvel Bianco Fantastico 120x278 Matt
- A0SE Marvel Bianco Fantastico 120x278 Lappato

- ▼
- AY2T Marvel Statuario Select 120x120 Lappato
- AY2P Marvel Statuario Select 120x240 Lappato
- A0BN Marvel Statuario Select 120x278 Lappato

- ▼
- A207 Marvel Carrara Pure 120x120
- AZTU Marvel Carrara Pure 120x120 Lappato
- AZTW Marvel Carrara Pure 120x240 Lappato
- A2RV Marvel Carrara Pure 120x278 Matt
- A2RW Marvel Carrara Pure 120x278 Lappato

- ▼
- A204 Marvel Bianco Dolomite 120x120 Matt
- AZTT Marvel Bianco Dolomite 120x120 Lappato
- AZTV Marvel Bianco Dolomite 120x240 Lappato
- A2RS Marvel Bianco Dolomite 120x278 Matt
- A0BP Marvel Bianco Dolomite 120x278 Lappato
- A0S3 Marvel Bianco Dolomite 160x160RT Lappato
- A0SX Marvel Bianco Dolomite 160x320RT Lappato

atlasPLAN SINGLE SLAB NON RECTIFIED
162x324 cm - 63³/₄"x127¹/₂"

▼
AAVG Bianco Dolomite A Polished - 12mm ST *

XL Large Sizes

Porcelain Tiles / Gres Porcellanato

MARBLE LOOK



Marvel Pro
CREMO DELICATO

Sizes	Thickness	Surface finish
120x120 cm - 47 1/4" x 47 1/4"	± 9 mm	Polished Matte
120x240 cm - 47 1/4" x 94 1/2"	± 9 mm	Polished
120x278 cm - 47 1/4" x 109 1/2"	± 6 mm	Polished Matte
160x160 cm - 63" x 63"	± 6 mm	Polished
160x320 cm - 63" x 126"	± 6 mm	Polished

- ▼
- A206** Marvel Crema Delicato 120x120 Matt
- AY2U** Marvel Crema Delicato 120x120 Lappato
- AY2Q** Marvel Crema Delicato 120x240 Lappato
- A2RU** Marvel Crema Delicato 120x278 Matt
- A080** Marvel Crema Delicato 120x278 Lappato
- A052** Marvel Crema Delicato 160x160RT Lappato
- A05W** Marvel Crema Delicato 160x320RT Lappato



Marvel Shine
CALACATTA IMPERIALE

Sizes	Thickness	Surface finish
120x120 cm - 47 1/4" x 47 1/4"	± 9 mm	Polished Matte
120x240 cm - 47 1/4" x 94 1/2"	± 9 mm	Polished
120x278 cm - 47 1/4" x 109 1/2"	± 6 mm	Polished

- ▼
- A4Q7** Marvel Calacatta Imperiale 120x120 Matt
- A4RB** Marvel Calacatta Imperiale 120x120 Lappato
- A4RK** Marvel Calacatta Imperiale 120x240 Lappato
- A401** Marvel Calacatta Imperiale 120x278 Lappato

VEINS CONTINUITY ▲■ (SEE PAGE 553)

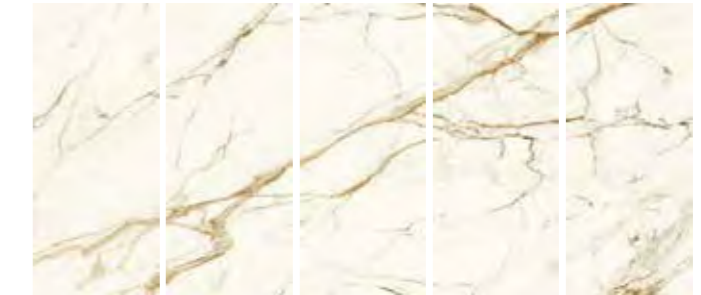

120x278 cm - 47 1/4" x 109 1/2" ± 6 mm Polished

▼

A6EQ Marvel Calacatta Imperiale 120x278 Lappato Kit Endless

atlasPLAN SINGLE SLAB NON RECTIFIED
162x324 cm - 63 3/4" x 127 1/2"

CALACATTA IMPERIALE CALACATTA IMPERIALE BOOKMATCH CALACATTA IMPERIALE NATURA VEIN

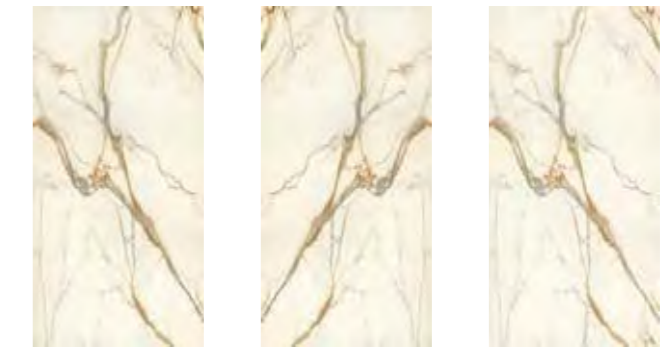

162x324 cm - 63 3/4" x 127 1/2" ± 6 mm Silk
162x324 cm - 63 3/4" x 127 1/2" ± 12 mm Polished | Satin | Silk
162x324 cm - 63 3/4" x 127 1/2" ± 20 mm Polished | Silk

NON-RECTIFIED

▼

- A2YG** Calacatta Imperiale Silk - 6mm ST *
- A2YH** Calacatta Imperiale Bookmatch Silk - 6mm ST *
- A0XI** Calacatta Imperiale Polished - 12mm ST *
- A0XT** Calacatta Imperiale Bookmatch Polished - 12mm ST *
- A3M9** Calacatta Imperiale Satin - 12mm ST *
- A4I1** Calacatta Imperiale Bookmatch Satin - 12mm ST *
- A0XV** Calacatta Imperiale Silk - 12mm ST *
- A0XX** Calacatta Imperiale Bookmatch Silk - 12mm ST *
- A1AE** Calacatta Imperiale Polished NATURA VEIN - 20mm
- A16W** Calacatta Imperiale Silk NATURA VEIN - 20mm

XL Large Sizes

Porcelain Tiles / Gres Porcellanato

MARBLE LOOK



Marvel Edge
ROYAL CALACATTA

Sizes	Thickness	Surface finish
120x120 cm - 47 1/4"x47 1/4"	± 9 mm	Polished
120x240 cm - 47 1/4"x94 1/2"	± 9 mm	Polished
120x278 cm - 47 1/4"x109 1/2"	± 6 mm	Polished

atlasPLAN SINGLE SLAB NON RECTIFIED
162x324 cm - 63 3/4"x127 1/2"

ROYAL CALACATTA ROYAL CALACATTA BOOKMATCH



162x324 cm - 63 3/4"x127 1/2" ± 12 mm Polished
NON-RECTIFIED

AA17 Calacatta Royal Polished - 12mm ST *
AA9M Calacatta Royal Bookmatch Polished - 12mm ST *



Marvel Edge
IMPERIAL WHITE

Sizes	Thickness	Surface finish
120x120 cm - 47 1/4"x47 1/4"	± 9 mm	Polished



Marvel Edge
ELEGANT SABLE

Sizes	Thickness	Surface finish
120x120 cm - 47 1/4"x47 1/4"	± 9 mm	Polished



Marvel Edge
GRIS SUPREME

Sizes	Thickness	Surface finish
120x120 cm - 47 1/4"x47 1/4"	± 9 mm	Polished

AENQ Marvel Imperial White 120x120 Lappato
AENN Marvel Gris Supreme 120x120 Lappato

AENK Marvel Elegant Sable 120x120 Lappato

XL Large Sizes

Porcelain Tiles / Gres Porcellanato

MARBLE LOOK

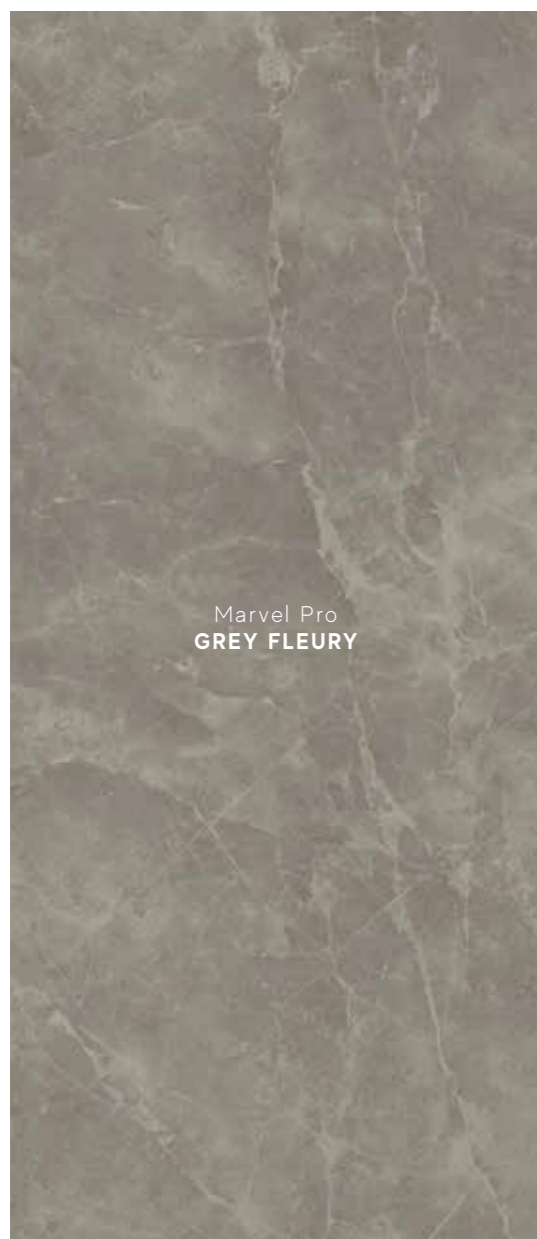

Marvel Pro
GREY FLEURY

Sizes	Thickness	Surface finish
120x120 cm - 47 ¹ / ₄ "x47 ¹ / ₄ "	± 9 mm	Polished Matte
120x278 cm - 47 ¹ / ₄ "x109 ¹ / ₂ "	± 6 mm	Polished Matte



Marvel
GREY STONE

Sizes	Thickness	Surface finish
120x120 cm - 47 ¹ / ₄ "x47 ¹ / ₄ "	± 9 mm	Polished Matte
120x240 cm - 47 ¹ / ₄ "x94 ¹ / ₂ "	± 9 mm	Polished
120x278 cm - 47 ¹ / ₄ "x109 ¹ / ₂ "	± 6 mm	Polished Matte

162x324 cm - 63³/₄"x127¹/₂"
> NON-RECTIFIED

Thickness	Surface finish
± 6, 12, 20 mm	Silk

atlasPLAN SINGLE SLAB NON RECTIFIED
162x324 cm - 63³/₄"x127¹/₂"

- ▼
- A205 Marvel Grey Fleury 120x120 Matt
- A210 Marvel Grey Fleury 120x120 Lappato
- A2RT Marvel Grey Fleury 120x278 Matt
- A2RX Marvel Grey Fleury 120x278 Lappato
- ▼
- AEQY Marvel Grey Stone 120x120 Matt
- AY2S Marvel Grey Stone 120x120 Lappato
- AY2O Marvel Grey Stone 120x240 Lappato
- A2RP Marvel Grey Stone 120x278 Matt
- AOQD Marvel Grey Stone 120x278 Lappato

- ▼
- AN1V Grey Stone Silk - 6mm ST *
- AAWA Grey Stone Silk - 12mm ST *
- AN2B Grey Stone Silk - 20mm



Marvel Dream
GRIGIO INTENSO

Sizes	Thickness	Surface finish
120x120 cm - 47 ¹ / ₄ "x47 ¹ / ₄ "	± 9 mm	Polished
120x240 cm - 47 ¹ / ₄ "x94 ¹ / ₂ "	± 9 mm	Polished
120x278 cm - 47 ¹ / ₄ "x109 ¹ / ₂ "	± 6 mm	Polished

162x324 cm - 63³/₄"x127¹/₂"
> NON-RECTIFIED

Thickness	Surface finish
± 6 mm	Silk
± 12 mm	Polished

atlasPLAN SINGLE SLAB NON RECTIFIED
162x324 cm - 63³/₄"x127¹/₂"

- ▼
- AL70 Marvel Grigio Intenso 120x120 Lappato
- A03Q Marvel Grigio Intenso 120x240 Lappato
- A0SF Marvel Grigio Intenso 120x278 Lappato

- ▼
- A2YI Grigio Intenso Silk - 6mm ST *
- A0Y9 Grigio Intenso Silk - 12mm ST *
- AL91 Grigio Intenso Polished - 12mm ST *

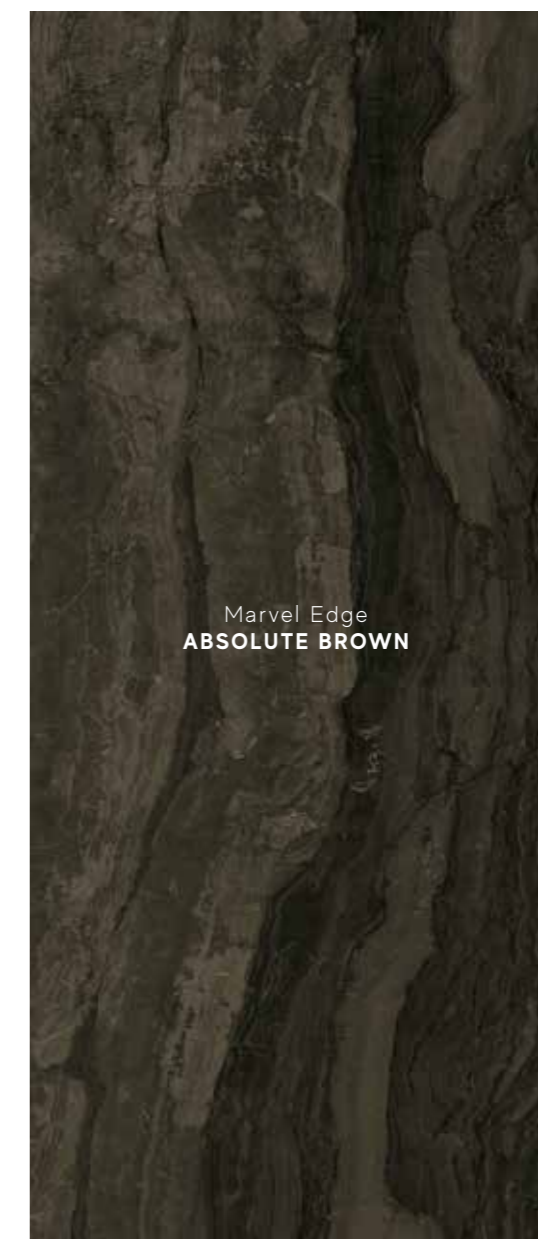

Marvel Edge
ABSOLUTE BROWN

Sizes	Thickness	Surface finish
120x120 cm - 47 ¹ / ₄ "x47 ¹ / ₄ "	± 9 mm	Polished
120x240 cm - 47 ¹ / ₄ "x94 ¹ / ₂ "	± 9 mm	Polished
120x278 cm - 47 ¹ / ₄ "x109 ¹ / ₂ "	± 6 mm	Polished

- ▼
- AENO Marvel Absolute Brown 120x120 Lappato
- AENT Marvel Absolute Brown 120x240 Lappato
- AOQC Marvel Absolute Brown 120x278 Lappato

LARGE SIZES

LARGE SIZES

XL Large Sizes

Porcelain Tiles / Gres Porcellanato

MARBLE LOOK

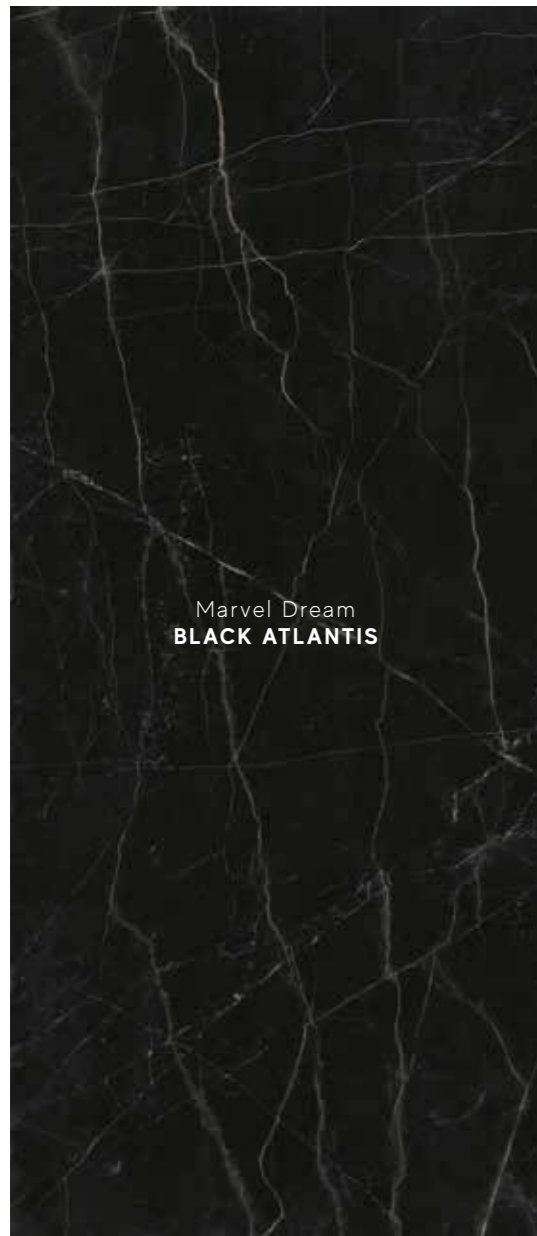

Marvel Dream
BLACK ATLANTIS

Sizes	Thickness	Surface finish
120x120 cm - 47 1/4" x 47 1/4"	± 9 mm	Polished Matte
120x240 cm - 47 1/4" x 94 1/2"	± 9 mm	Polished
120x278 cm - 47 1/4" x 109 1/2"	± 6 mm	Polished Matte



Marvel Dream
ULTRAMARINE

Sizes	Thickness	Surface finish
120x278 cm - 47 1/4" x 109 1/2"	± 6 mm	Polished

AL2I Marvel Ultramarine 120x278 Lappato*

* Ultramarine 120x278 cm: Glazed Porcelain tiles

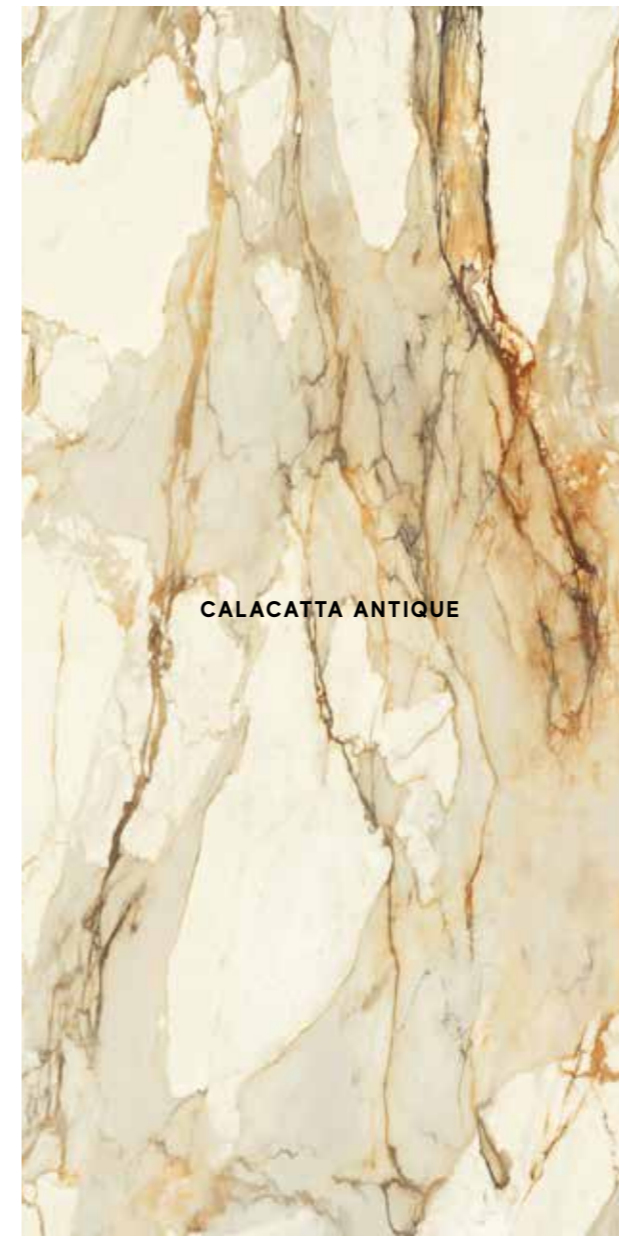

CALACATTA ANTIQUE

Sizes	Thickness	Surface finish
162x324 cm - 63 3/4" x 127 1/2"	± 12 mm	Polished
> NON-RECTIFIED		

atlasPLAN SINGLE SLAB NON RECTIFIED
162x324 cm - 63 3/4" x 127 1/2"

A0XZ Calacatta Antique Polished - 12mm ST*



Marvel Stone
CREAM PRESTIGE

Sizes	Thickness	Surface finish
162x324 cm - 63 3/4" x 127 1/2"	± 12 mm	Silk
> NON-RECTIFIED		

atlasPLAN SINGLE SLAB NON RECTIFIED
162x324 cm - 63 3/4" x 127 1/2"

AAV6 Cream Prestige Silk - 12mm ST*

LARGE SIZES

LARGE SIZES

A20Z Marvel Black Atlantis 120x120 Matt
 AL7P Marvel Black Atlantis 120x120 Lappato
 A03R Marvel Black Atlantis 120x240 Lappato
 A2RQ Marvel Black Atlantis 120x278 Matt
 A0SG Marvel Black Atlantis 120x278 Lappato

XL Large Sizes

Porcelain Tiles / Gres Porcellanato

MARBLE LOOK



WHITE CLOUD

Sizes	Thickness	Surface finish
162x324 cm - 63 ³ / ₄ "x127 ¹ / ₂ "	± 12 mm	Silk
> NON-RECTIFIED		

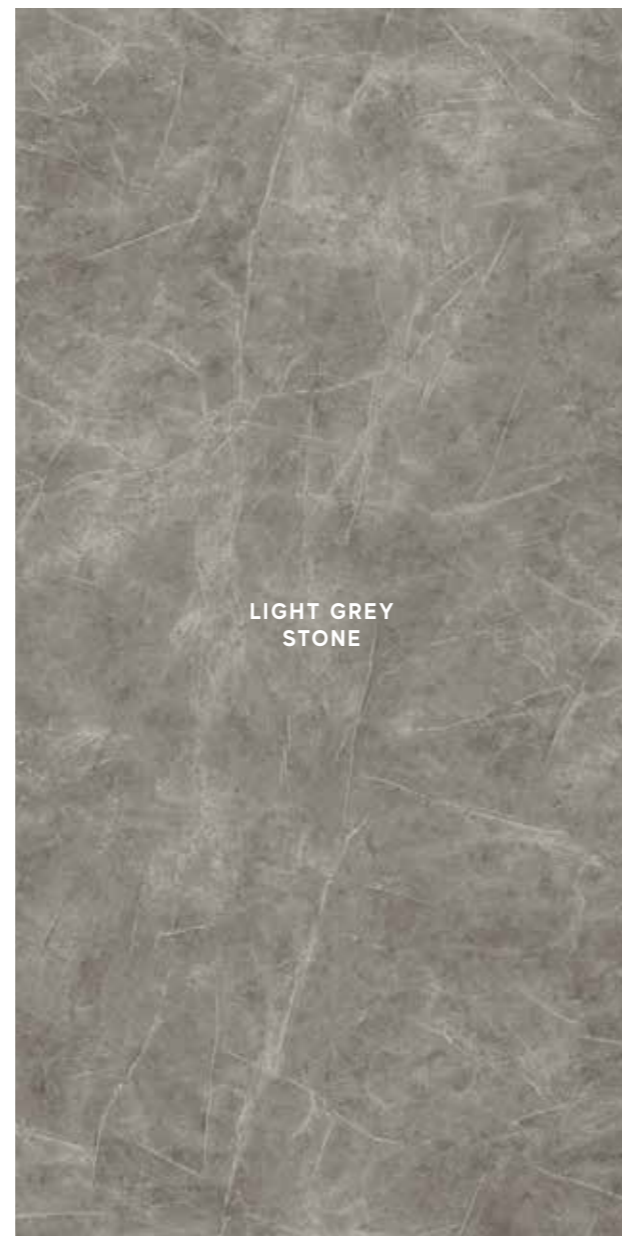

LIGHT GREY STONE

Sizes	Thickness	Surface finish
162x324 cm - 63 ³ / ₄ "x127 ¹ / ₂ "	± 12 mm	Silk
> NON-RECTIFIED		

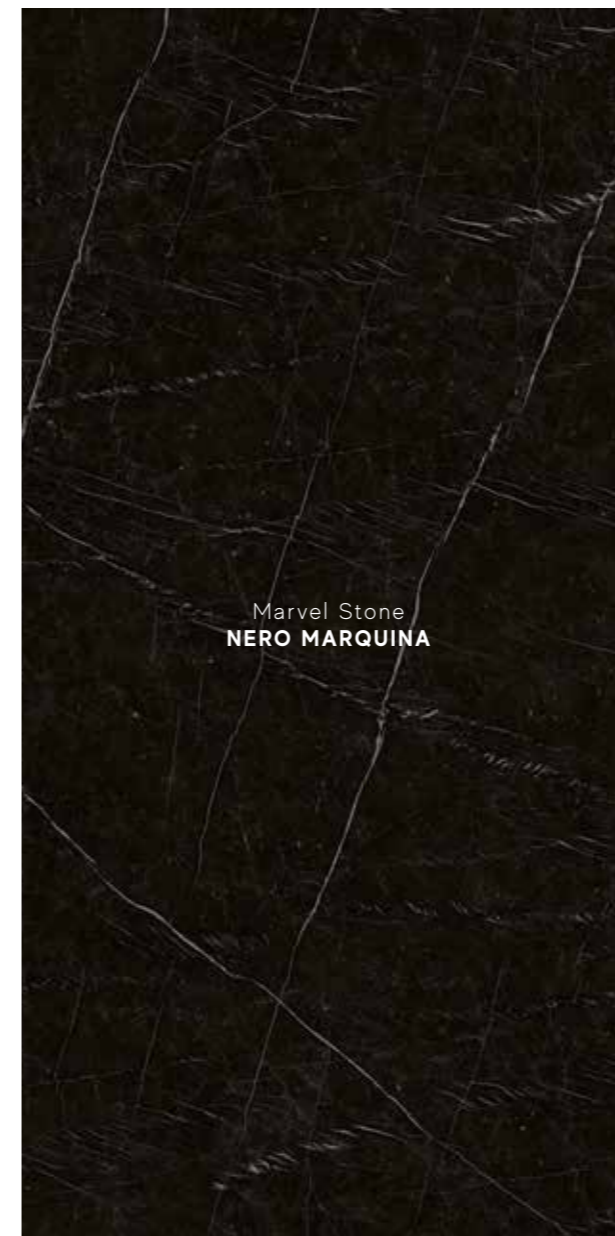

Marvel Stone
NERO MARQUINA

Sizes	Thickness	Surface finish
162x324 cm - 63 ³ / ₄ "x127 ¹ / ₂ "	± 6 mm	Silk
> NON-RECTIFIED		
	± 12 mm	Polished Silk Satin
	± 20 mm	Silk

atlasPLAN SINGLE SLAB NON RECTIFIED
162x324 cm - 63³/₄"x127¹/₂"

▼
A4UO White Cloud Silk - 12 mm ST *

atlasPLAN SINGLE SLAB NON RECTIFIED
162x324 cm - 63³/₄"x127¹/₂"

▼
AMJ9 Light Grey Stone Silk - 12mm ST *

atlasPLAN SINGLE SLAB NON RECTIFIED
162x324 cm - 63³/₄"x127¹/₂"

- ▼
- A07Y Nero Marquina Silk - 6mm ST *
 - ANWA Nero Marquina Polished - 12mm ST *
 - ANVK Nero Marquina Silk - 12mm ST *
 - A3M5 Nero Marquina Satin - 12mm ST *
 - A2XT Nero Marquina Silk - 20mm

XL Large Sizes

Porcelain Tiles / Gres Porcellanato

METAL LOOK

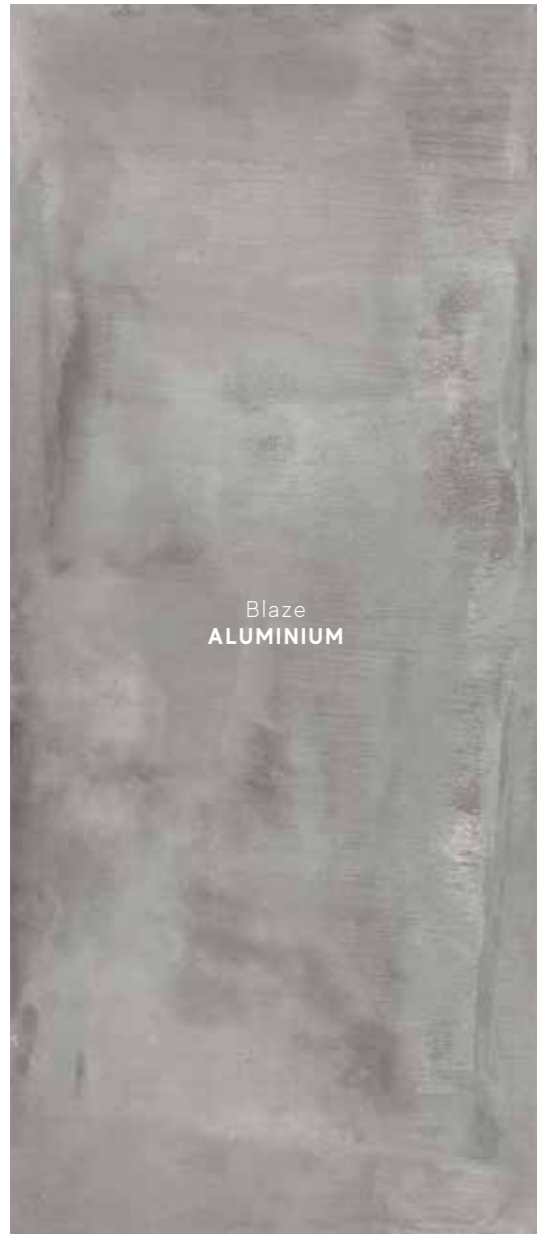

Blaze
ALUMINIUM

Sizes	Thickness	Surface finish
120x120 cm - 47 ¹ / ₄ "x47 ¹ / ₄ "	± 9 mm	Matte
120x278 cm - 47 ¹ / ₄ "x109 ¹ / ₂ "	± 6 mm	Matte

▼
APPK Blaze Aluminium 120x120
APO7 Blaze Aluminium 120x278



Blaze
CORTEN

Sizes	Thickness	Surface finish
120x120 cm - 47 ¹ / ₄ "x47 ¹ / ₄ "	± 9 mm	Matte
120x278 cm - 47 ¹ / ₄ "x109 ¹ / ₂ "	± 6 mm	Matte

▼
APPW Blaze Corten 120x120
APO8 Blaze Corten 120x278



Blaze
IRON

Sizes	Thickness	Surface finish
120x120 cm - 47 ¹ / ₄ "x47 ¹ / ₄ "	± 9 mm	Matte
120x278 cm - 47 ¹ / ₄ "x109 ¹ / ₂ "	± 6 mm	Matte
162x324 cm - 63 ³ / ₄ "x127 ¹ / ₂ "	± 12 mm	Matte

> NON-RECTIFIED

▼
APPX Blaze Iron 120x120
APO9 Blaze Iron 120x278

atlasPLAN SINGLE SLAB NON RECTIFIED
162x324 cm - 63³/₄"x127¹/₂"

▼
A3ND Blaze Iron Matt - 12mm ST *

LARGE SIZES

LARGE SIZES

XL Large Sizes

Porcelain Tiles / Gres Porcellanato

CONCRETE LOOK

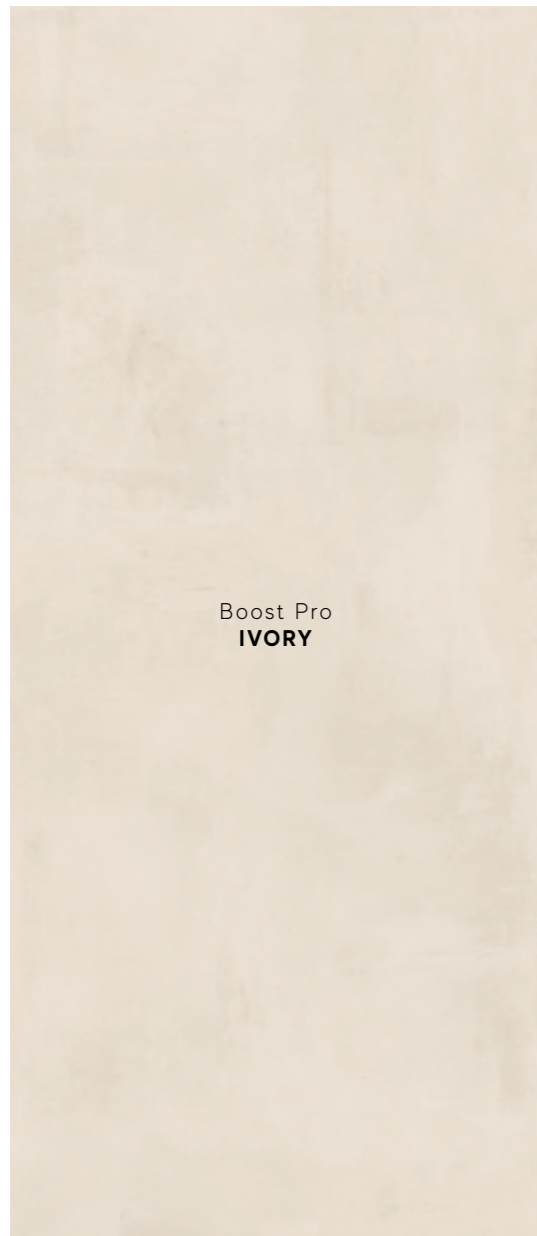

Boost Pro
IVORY

Sizes	Thickness	Surface finish
120x120 cm - 47 1/4" x 47 1/4"	± 9 mm	Matte
120x240 cm - 47 1/4" x 94 1/2"	± 9 mm	Matte
120x120 cm - 47 1/4" x 47 1/4"	± 6 mm	Matte
120x278 cm - 47 1/4" x 109 1/2"	± 6 mm	Matte



Boost
WHITE

Sizes	Thickness	Surface finish
120x120 cm - 47 1/4" x 47 1/4"	± 9 mm	Matte
120x240 cm - 47 1/4" x 94 1/2"	± 9 mm	Matte
120x120 cm - 47 1/4" x 47 1/4"	± 6 mm	Matte
120x278 cm - 47 1/4" x 109 1/2"	± 6 mm	Matte
160x160 cm - 63" x 63"	± 6 mm	Matte
160x320 cm - 63" x 126"	± 6 mm	Matte
162x324 cm - 63 3/4" x 127 1/2"	± 6-12 mm	Hammered

> NON-RECTIFIED

A2TK Boost White 120x120 6mm
 AMGI Boost White 120x120
 AMGD Boost White 120x240
 A0BD Boost White 120x278
 A0DE Boost White 160x160RT
 A0SZ Boost White 160x320RT
 atlasPLAN SINGLE SLAB NON RECTIFIED
 162x324 cm - 63 3/4" x 127 1/2"
 AN1M Boost White Hammered - 6mm ST *
 ANVX Boost White Hammered - 12mm ST *

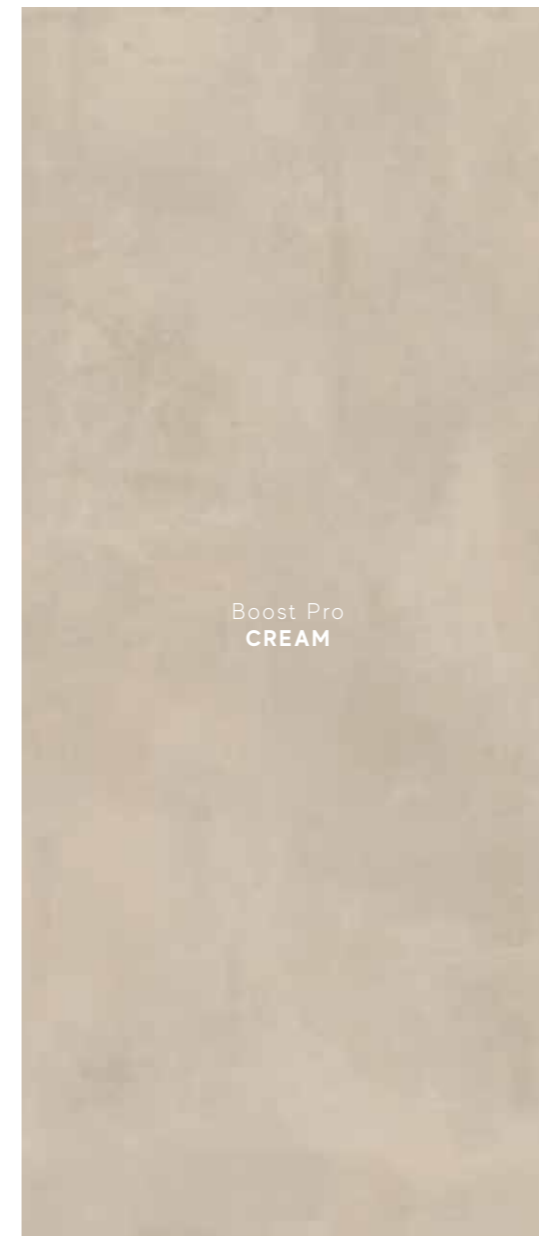

Boost Pro
CREAM

Sizes	Thickness	Surface finish
120x120 cm - 47 1/4" x 47 1/4"	± 9 mm	Matte
120x240 cm - 47 1/4" x 94 1/2"	± 9 mm	Matte
120x120 cm - 47 1/4" x 47 1/4"	± 6 mm	Matte
120x278 cm - 47 1/4" x 109 1/2"	± 6 mm	Matte

A0CR Boost Pro Cream 120x120 6mm
 A0AH Boost Pro Cream 120x120
 A0CG Boost Pro Cream 120x240
 A0CM Boost Pro Cream 120x278



Boost
PEARL

Sizes	Thickness	Surface finish
120x120 cm - 47 1/4" x 47 1/4"	± 9 mm	Matte
120x240 cm - 47 1/4" x 94 1/2"	± 9 mm	Matte
120x120 cm - 47 1/4" x 47 1/4"	± 6 mm	Matte
120x278 cm - 47 1/4" x 109 1/2"	± 6 mm	Matte

A2TM Boost Pearl 120x120 6mm
 AMGJ Boost Pearl 120x120
 AMGE Boost Pearl 120x240
 A0BE Boost Pearl 120x278

LARGE SIZES

LARGE SIZES

XL Large Sizes

Porcelain Tiles / Gres Porcellanato

CONCRETE LOOK

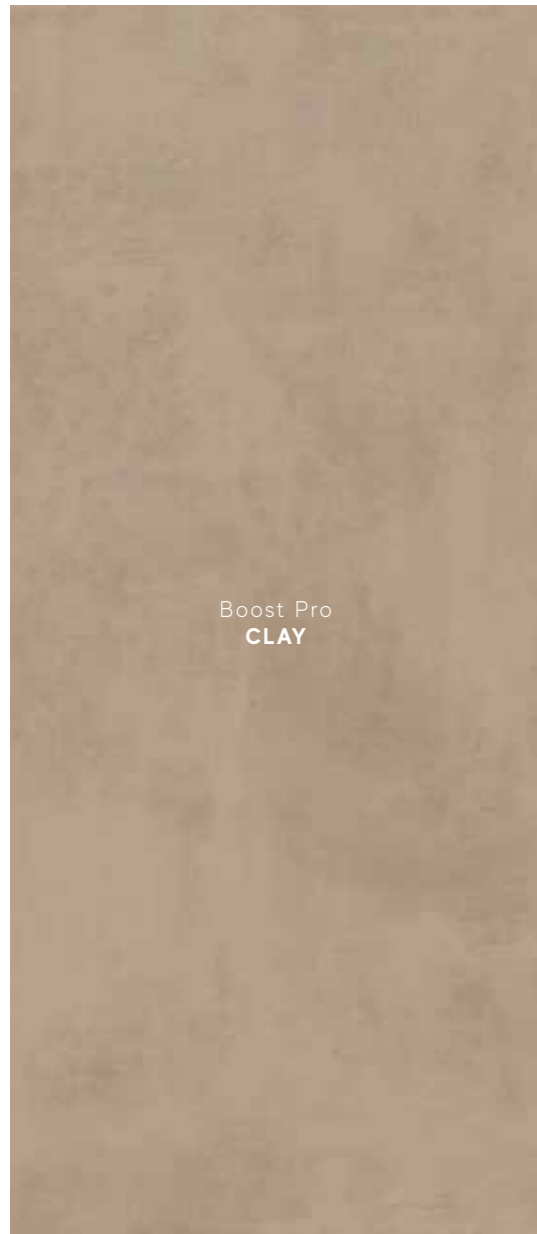

Boost Pro
CLAY

Sizes	Thickness	Surface finish
120x120 cm - 47 1/4" x 47 1/4"	± 9 mm	Matte
120x240 cm - 47 1/4" x 94 1/2"	± 9 mm	Matte
120x120 cm - 47 1/4" x 47 1/4"	± 6 mm	Matte
120x278 cm - 47 1/4" x 109 1/2"	± 6 mm	Matte
160x160 cm - 63" x 63"	± 6 mm	Matte
160x320 cm - 63" x 126"	± 6 mm	Matte

- ▼
- A0CS Boost Pro Clay 120x120 6mm
- A0AJ Boost Pro Clay 120x120
- A0CJ Boost Pro Clay 120x240
- A0CN Boost Pro Clay 120x278
- A0QG Boost Pro Clay 160x160
- A0QE Boost Pro Clay 160x320



Boost
GREY

Sizes	Thickness	Surface finish
120x120 cm - 47 1/4" x 47 1/4"	± 9 mm	Matte
120x240 cm - 47 1/4" x 94 1/2"	± 9 mm	Matte
120x120 cm - 47 1/4" x 47 1/4"	± 6 mm	Matte
120x278 cm - 47 1/4" x 109 1/2"	± 6 mm	Matte

- ▼
- AZTN Boost Grey 120x120 6mm
- AMGK Boost Grey 120x120
- AMGF Boost Grey 120x240
- A0BF Boost Grey 120x278



Boost Pro
TAUPE

Sizes	Thickness	Surface finish
120x120 cm - 47 1/4" x 47 1/4"	± 9 mm	Matte
120x240 cm - 47 1/4" x 94 1/2"	± 9 mm	Matte
120x120 cm - 47 1/4" x 47 1/4"	± 6 mm	Matte
120x278 cm - 47 1/4" x 109 1/2"	± 6 mm	Matte
160x160 cm - 63" x 63"	± 6 mm	Matte
160x320 cm - 63" x 126"	± 6 mm	Matte

- ▼
- A0CT Boost Pro Taupe 120x120 6mm
- A0AL Boost Pro Taupe 120x120
- A0CH Boost Pro Taupe 120x240
- A0CO Boost Pro Taupe 120x278
- A0QH Boost Pro Taupe 160x160
- A0QF Boost Pro Taupe 160x320



Boost
SMOKE

Sizes	Thickness	Surface finish
120x120 cm - 47 1/4" x 47 1/4"	± 9 mm	Matte
120x240 cm - 47 1/4" x 94 1/2"	± 9 mm	Matte
120x120 cm - 47 1/4" x 47 1/4"	± 6 mm	Matte
120x278 cm - 47 1/4" x 109 1/2"	± 6 mm	Matte
160x160 cm - 63" x 63"	± 6 mm	Matte
160x320 cm - 63" x 126"	± 6 mm	Matte
162x324 cm - 63 3/4" x 127 1/2"	± 6, 12	Hammered
→ NON-RECTIFIED		20 mm

- ▼
 - AZTO Boost Smoke 120x120 6mm
 - AMGL Boost Smoke 120x120
 - AMGG Boost Smoke 120x240
 - A0BG Boost Smoke 120x278
 - A0DF Boost Smoke 160x160RT
 - A0S0 Boost Smoke 160x320RT
- atlasPLAN SINGLE SLAB NON RECTIFIED
162x324 cm - 63 3/4" x 127 1/2"
- ▼
 - AN10 Boost Smoke Hammered - 6mm ST *
 - ANV0 Boost Smoke Hammered - 12mm ST *
 - A2XV Boost Smoke Hammered - 20mm

XL Large Sizes

Porcelain Tiles / Gres Porcellanato

CONCRETE LOOK



Boost Pro
TOBACCO

Sizes	Thickness	Surface finish
120x120 cm - 47 1/4"x47 1/4"	± 9 mm	Matte
120x240 cm - 47 1/4"x94 1/2"	± 9 mm	Matte
120x120 cm - 47 1/4"x47 1/4"	± 6 mm	Matte
120x278 cm - 47 1/4"x109 1/2"	± 6 mm	Matte

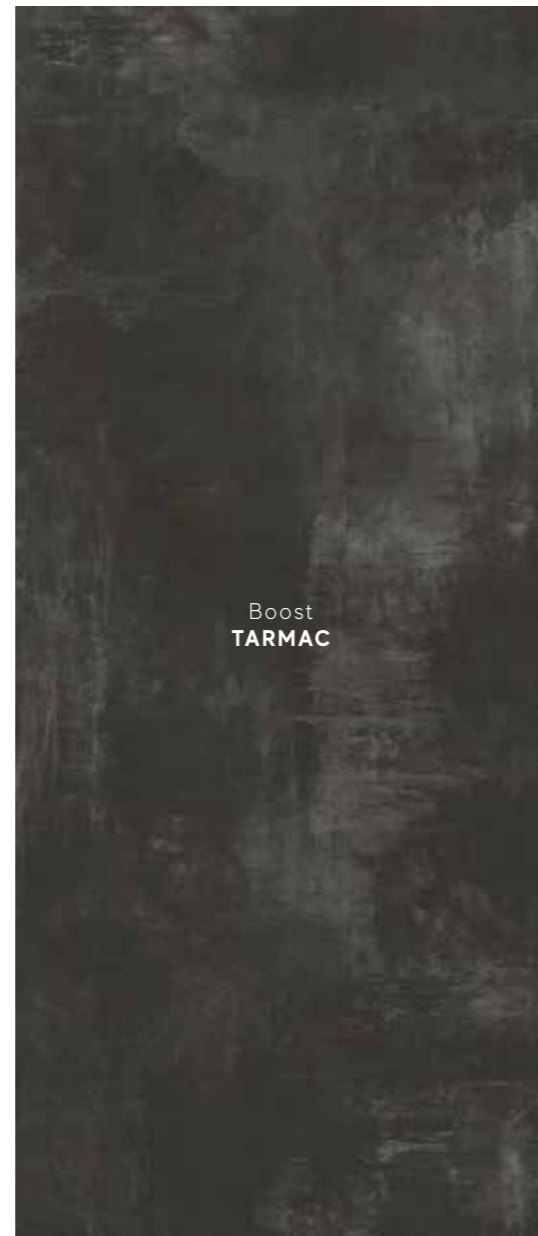

Boost
TARMAC

Sizes	Thickness	Surface finish
120x120 cm - 47 1/4"x47 1/4"	± 9 mm	Matte
120x240 cm - 47 1/4"x94 1/2"	± 9 mm	Matte
120x120 cm - 47 1/4"x47 1/4"	± 6 mm	Matte
120x278 cm - 47 1/4"x109 1/2"	± 6 mm	Matte



Raw
WHITE

Sizes	Thickness	Surface finish
120x120 cm - 47 1/4"x47 1/4"	± 9 mm	Matte
120x278 cm - 47 1/4"x109 1/2"	± 6 mm	Matte



Raw
PEARL

Sizes	Thickness	Surface finish
120x120 cm - 47 1/4"x47 1/4"	± 9 mm	Matte
120x278 cm - 47 1/4"x109 1/2"	± 6 mm	Matte

▼
A0CU Boost Pro Tobacco 120x120 6mm
A0AN Boost Pro Tobacco 120x120
A0CI Boost Pro Tobacco 120x240
A0CP Boost Pro Tobacco 120x278

▼
AZTP Boost Tarmac 120x120 6mm
AMGM Boost Tarmac 120x120
AMGH Boost Tarmac 120x240
AOQB Boost Tarmac 120x278

▼
APMK Raw White 120x120
APMW Raw White 120x278

▼
APML Raw Pearl 120x120
APMX Raw Pearl 120x278

XL Large Sizes

Porcelain Tiles / Gres Porcellanato

CONCRETE LOOK



Raw
SAND

Sizes	Thickness	Surface finish
120x120 cm - 47 1/4"x47 1/4"	± 9 mm	Matte
120x278 cm - 47 1/4"x109 1/2"	± 6 mm	Matte



Raw
MUD

Sizes	Thickness	Surface finish
120x120 cm - 47 1/4"x47 1/4"	± 9 mm	Matte
120x278 cm - 47 1/4"x109 1/2"	± 6 mm	Matte



Prism
SUEDE

Sizes	Thickness	Surface finish
120x120 cm - 47 1/4"x47 1/4"	± 9 mm	Silk I Matte
120x278 cm - 47 1/4"x109 1/2"	± 6 mm	Matte



Prism
CORD

Sizes	Thickness	Surface finish
120x120 cm - 47 1/4"x47 1/4"	± 9 mm	Silk I Matte
120x278 cm - 47 1/4"x109 1/2"	± 6 mm	Matte

▼
APMU Raw Sand 120x120
APMY Raw Sand 120x278

▼
APMV Raw Mud 120x120
APMZ Raw Mud 120x278

▼
A40M Prism Suede 120x120 Silk
A40G Prism Suede 120x120
A40P Prism Suede 120x278

▼
A40N Prism Cord 120x120 Silk
A40H Prism Cord 120x120
A40Q Prism Cord 120x278

LARGE SIZES

LARGE SIZES

XL Large Sizes

Porcelain Tiles / Gres Porcellanato

CONCRETE LOOK



Prism
COTTON

Sizes	Thickness	Surface finish
120x120 cm - 47 1/4"x47 1/4"	± 9 mm	Silk I Matte
120x278 cm - 47 1/4"x109 1/2"	± 6 mm	Matte



Prism
CLOUD

Sizes	Thickness	Surface finish
120x120 cm - 47 1/4"x47 1/4"	± 9 mm	Silk I Matte
120x278 cm - 47 1/4"x109 1/2"	± 6 mm	Matte



Prism
FOG

Sizes	Thickness	Surface finish
120x120 cm - 47 1/4"x47 1/4"	± 9 mm	Silk I Matte
120x278 cm - 47 1/4"x109 1/2"	± 6 mm	Matte



Prism
GRAPHITE

Sizes	Thickness	Surface finish
120x120 cm - 47 1/4"x47 1/4"	± 9 mm	Silk I Matte
120x278 cm - 47 1/4"x109 1/2"	± 6 mm	Matte

- ▼
- A400 Prism Cotton 120x120 Silk
- A40I Prism Cotton 120x120
- A4UR Prism Cotton 120x278

- ▼
- A40P Prism Cloud 120x120 Silk
- A40J Prism Cloud 120x120
- A4US Prism Cloud 120x278

- ▼
- A40Q Prism Fog 120x120 Silk
- A40K Prism Fog 120x120
- A4UT Prism Fog 120x278

- ▼
- A40R Prism Graphite 120x120 Silk
- A40L Prism Graphite 120x120
- A4UU Prism Graphite 120x278

XL Large Sizes

Porcelain Tiles / Gres Porcellanato

CONCRETE LOOK

STONE LOOK



Dwell
OFF WHITE

Sizes	Thickness	Surface finish
120x120 cm - 47 1/4" x 47 1/4"	± 9 mm	Matte



Dwell
GREIGE

Sizes	Thickness	Surface finish
120x120 cm - 47 1/4" x 47 1/4"	± 9 mm	Matte



Dwell
GRAY

Sizes	Thickness	Surface finish
120x120 cm - 47 1/4" x 47 1/4"	± 9 mm	Matte



Dwell
SMOKE

Sizes	Thickness	Surface finish
120x120 cm - 47 1/4" x 47 1/4"	± 9 mm	Matte



Kone
WHITE

Sizes	Thickness	Surface finish
120x120 cm - 47 1/4" x 47 1/4"	± 9 mm	Matte
120x240 cm - 47 1/4" x 94 1/2"	± 9 mm	Matte



Kone
PEARL

Sizes	Thickness	Surface finish
120x120 cm - 47 1/4" x 47 1/4"	± 9 mm	Matte
120x240 cm - 47 1/4" x 94 1/2"	± 9 mm	Matte

▼
A1QJ Dwell Off White 120x120
A1QK Dwell Gray 120x120

▼
A1QL Dwell Greige 120x120
A1QM Dwell Smoke 120x120

▼
AULO Kone White 120x120
AULR Kone White 120x240

▼
AULP Kone Pearl 120x120
AULS Kone Pearl 120x240

LARGE SIZES

LARGE SIZES



Kone
GREY

Sizes	Thickness	Surface finish
120x120 cm - 47 ¹ / ₄ "x47 ¹ / ₄ "	± 9 mm	Matte
120x240 cm - 47 ¹ / ₄ "x94 ¹ / ₂ "	± 9 mm	Matte
162x324 cm - 63 ³ / ₄ "x127 ¹ / ₂ "	± 6, 12 mm	Hammered

> **NON-RECTIFIED**

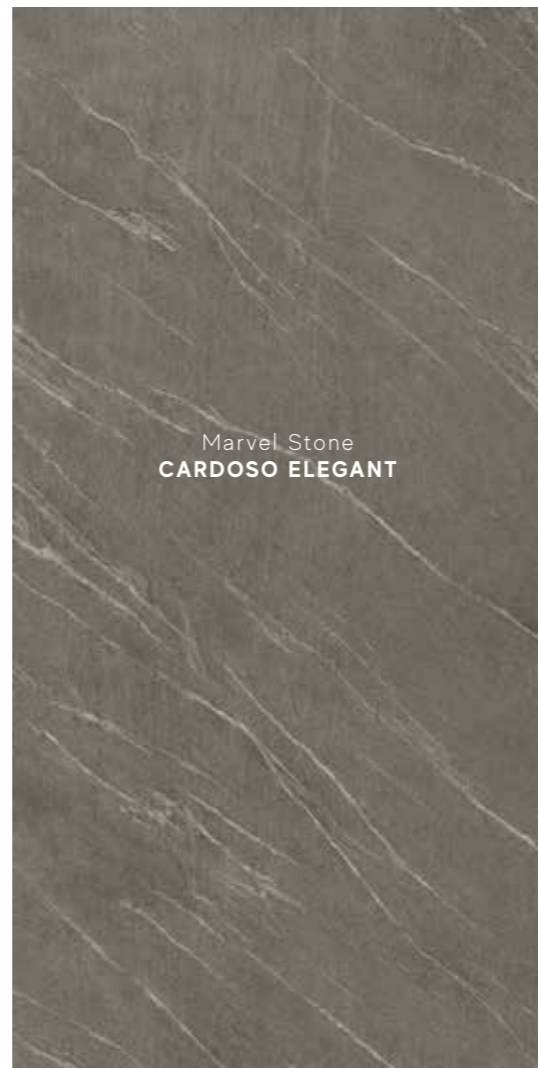

Marvel Stone
CARDOSO ELEGANT

Sizes	Thickness	Surface finish
120x120 cm - 47 ¹ / ₄ "x47 ¹ / ₄ "	± 9 mm	Matte
120x240 cm - 47 ¹ / ₄ "x94 ¹ / ₂ "	± 9 mm	Matte

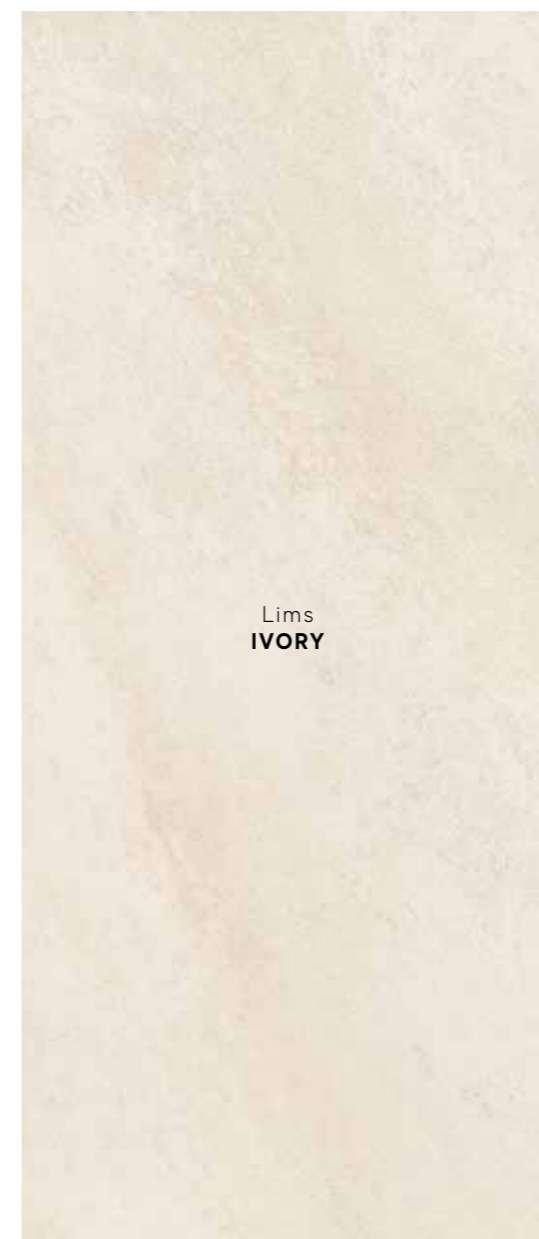

Lims
IVORY

Sizes	Thickness	Surface finish
120x120 cm - 47 ¹ / ₄ "x47 ¹ / ₄ "	± 9 mm	Matte
120x278 cm - 47 ¹ / ₄ "x109 ¹ / ₂ "	± 6 mm	Matte



Lims
BEIGE

Sizes	Thickness	Surface finish
120x120 cm - 47 ¹ / ₄ "x47 ¹ / ₄ "	± 9 mm	Matte
120x278 cm - 47 ¹ / ₄ "x109 ¹ / ₂ "	± 6 mm	Matte

atlasPLAN SINGLE SLAB NON RECTIFIED
162x324 cm - 63³/₄"x127¹/₂"

- ▼ **AULQ** Kone Grey 120x120
- ▼ **AULT** Kone Grey 120x240
- ▼ **AN1T** Kone Grey Hammered - 6mm ST *
- ▼ **ANXH** Kone Grey Hammered - 12mm ST *

- ▼ **AZT4** Marvel Cardoso Elegant 120x120
- ▼ **AZT1** Marvel Cardoso Elegant 120x240

- ▼ **A3DI** Lims Ivory 120x120
- ▼ **A3EI** Lims Ivory 120x278

- ▼ **A3DJ** Lims Beige 120x120
- ▼ **A3EJ** Lims Beige 120x278



Lims
GREY

Sizes	Thickness	Surface finish
120x120 cm - 47 ¹ / ₄ "x47 ¹ / ₄ "	± 9 mm	Matte
120x278 cm - 47 ¹ / ₄ "x109 ¹ / ₂ "	± 6 mm	Matte

▼
A3DK Lims Grey 120x120
A3EK Lims Grey 120x278

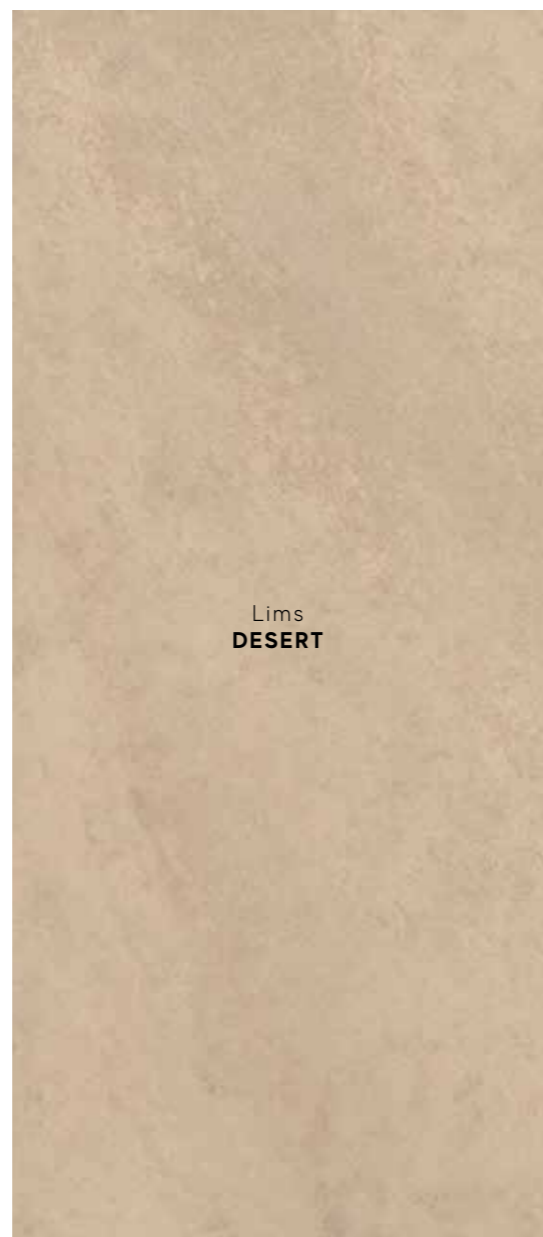

Lims
DESERT

Sizes	Thickness	Surface finish
120x120 cm - 47 ¹ / ₄ "x47 ¹ / ₄ "	± 9 mm	Matte
120x278 cm - 47 ¹ / ₄ "x109 ¹ / ₂ "	± 6 mm	Matte

▼
A3DL Lims Desert 120x120
A3EL Lims Desert 120x278



Aix
BLANC

Sizes	Thickness	Surface finish
120x120 cm - 47 ¹ / ₄ "x47 ¹ / ₄ "	± 9 mm	Matte

▼
A05N Aix Blanc 120x120
A05Q Aix Cendre 120x120



Aix
BEIGE

Sizes	Thickness	Surface finish
120x120 cm - 47 ¹ / ₄ "x47 ¹ / ₄ "	± 9 mm	Matte

▼
A05O Aix Beige 120x120
A05R Aix Fumée 120x120



Aix
CENDRE

Sizes	Thickness	Surface finish
120x120 cm - 47 ¹ / ₄ "x47 ¹ / ₄ "	± 9 mm	Matte



Aix
FUMÉE

Sizes	Thickness	Surface finish
120x120 cm - 47 ¹ / ₄ "x47 ¹ / ₄ "	± 9 mm	Matte



Marvel Stone
CLAUZETTO WHITE

Sizes	Thickness	Surface finish
120x120 cm - 47 ¹ / ₄ "x47 ¹ / ₄ "	± 9 mm	Matte
120x240 cm - 47 ¹ / ₄ "x94 ¹ / ₂ "	± 9 mm	Matte



Marvel Stone
BASALTINA VOLCANO

Sizes	Thickness	Surface finish
120x120 cm - 47 ¹ / ₄ "x47 ¹ / ₄ "	± 9 mm	Matte
120x240 cm - 47 ¹ / ₄ "x94 ¹ / ₂ "	± 9 mm	Matte
162x324 cm - 63 ³ / ₄ "x127 ¹ / ₂ "	± 6, 12, 20 mm	Hammered
> NON-RECTIFIED		

atlasPLAN SINGLE SLAB NON RECTIFIED
162x324 cm - 63³/₄"x127¹/₂"

- ▼
- AL9Z** Basaltina Volcano Hammered - 6mm ST *
- ANVI** Basaltina Volcano Hammered - 12mm ST *
- A2X5** Basaltina Volcano Hammered - 20mm

- ▼
- AZT5** Marvel Clauzetto White 120x120 Matt
- AZT2** Marvel Clauzetto White 120x240 Matt
- ▼
- AZT3** Marvel Basaltina Volcano 120x120 Matt
- AZT0** Marvel Basaltina Volcano 120x240 Matt

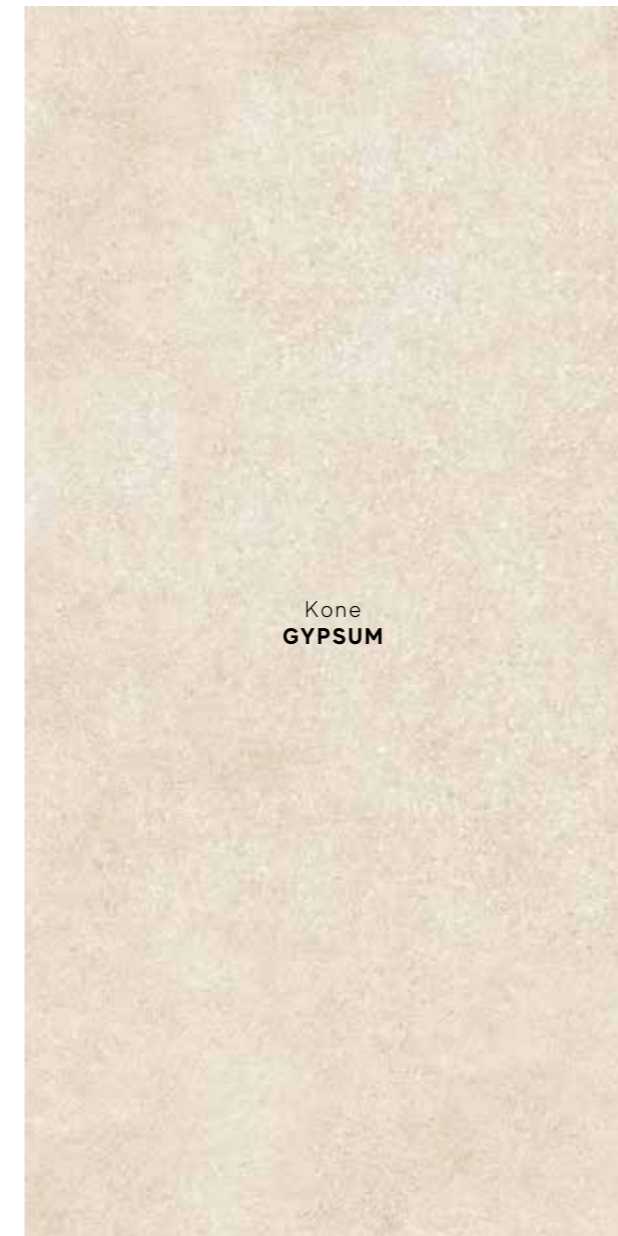

Kone
GYPSUM

Sizes	Thickness	Surface finish
162x324 cm - 63 ³ / ₄ "x127 ¹ / ₂ "	± 12 mm	Hammered
> NON-RECTIFIED		

atlasPLAN SINGLE SLAB NON RECTIFIED
162x324 cm - 63³/₄"x127¹/₂"

- ▼
- AMKD** Kone Gypsum Hammered - 12mm ST *

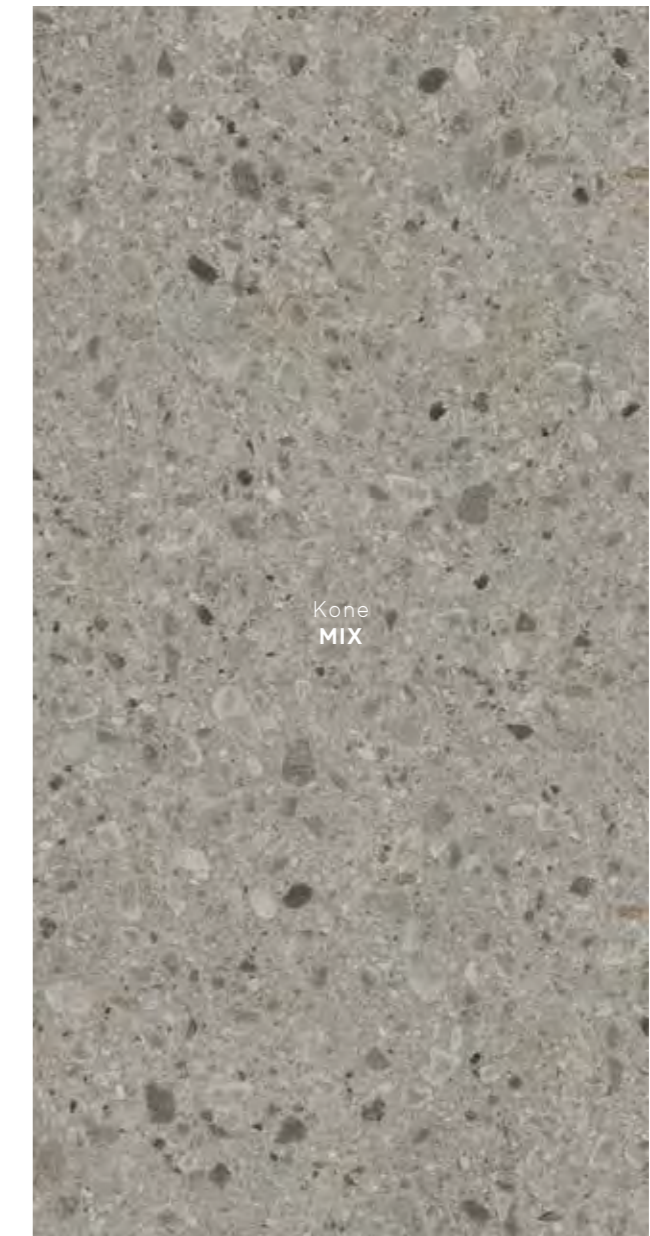

Kone
MIX

Sizes	Thickness	Surface finish
162x324 cm - 63 ³ / ₄ "x127 ¹ / ₂ "	± 6, 12 mm	Hammered
> NON-RECTIFIED		

atlasPLAN SINGLE SLAB NON RECTIFIED
162x324 cm - 63³/₄"x127¹/₂"

- ▼
- AN1Q** Kone Mix Hammered - 6mm ST *
- AMSX** Kone Mix Hammered - 12mm ST *



Dolmen Pro
GRIGIO

Sizes	Thickness	Surface finish
162x324 cm - 63 ³ / ₄ "x127 ¹ / ₂ "	± 6, 12, 20 mm	Flamed
> NON-RECTIFIED		

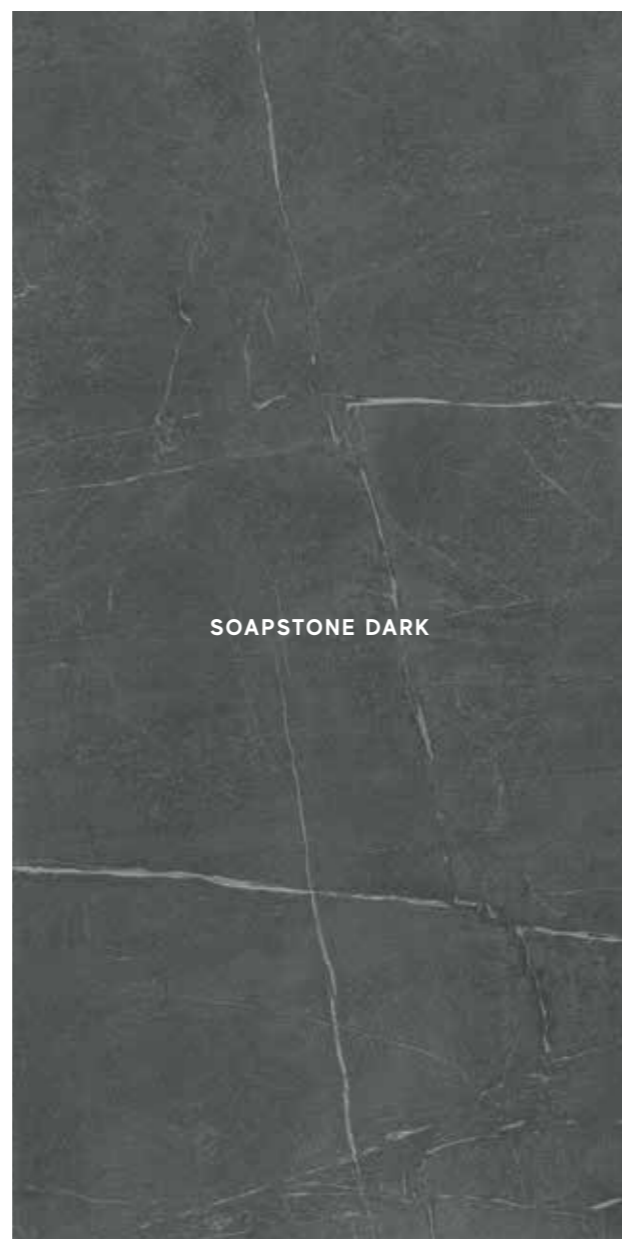

SOAPSTONE DARK

Sizes	Thickness	Surface finish
162x324 cm - 63 ³ / ₄ "x127 ¹ / ₂ "	± 12, 20 mm	Hammered
> NON-RECTIFIED		



Mek
MEDIUM

Sizes	Thickness	Surface finish
162x324 cm - 63 ³ / ₄ "x127 ¹ / ₂ "	± 12 mm	Matte
> NON-RECTIFIED		



Mek
DARK

Sizes	Thickness	Surface finish
162x324 cm - 63 ³ / ₄ "x127 ¹ / ₂ "	± 12 mm	Matte
> NON-RECTIFIED		

atlasPLAN SINGLE SLAB NON RECTIFIED
162x324 cm - 63³/₄"x127¹/₂"

- ▼
- A2YD Dolmen Pro Grigio Flamed - 6mm ST *
- A0X8 Dolmen Pro Grigio Flamed - 12mm ST *
- A2XP Dolmen Pro Grigio Flamed - 20mm

atlasPLAN SINGLE SLAB NON RECTIFIED
162x324 cm - 63³/₄"x127¹/₂"

- ▼
- A4UN Soapstone Dark Hammered - 12 mm ST *
- A5I3 Soapstone Dark Hammered - 20 mm *

atlasPLAN SINGLE SLAB NON RECTIFIED
162x324 cm - 63³/₄"x127¹/₂"

- ▼
- ANVV Mek Medium Matt - 12mm ST *

atlasPLAN SINGLE SLAB NON RECTIFIED
162x324 cm - 63³/₄"x127¹/₂"

- ▼
- ANVR Mek Dark Matt - 12mm ST *

XL Large Sizes

Porcelain Tiles / Gres Porcellanato



CONCRETE GREY

Sizes	Thickness	Surface finish
162x324 cm - 63 ³ / ₄ "x127 ¹ / ₂ "	± 12 mm	Silk
> NON-RECTIFIED		



ABSOLUTE WHITE

Sizes	Thickness	Surface finish
162x324 cm - 63 ³ / ₄ "x127 ¹ / ₂ "	± 6 mm	Matte
> NON-RECTIFIED	± 12, 20 mm	Silk Polished

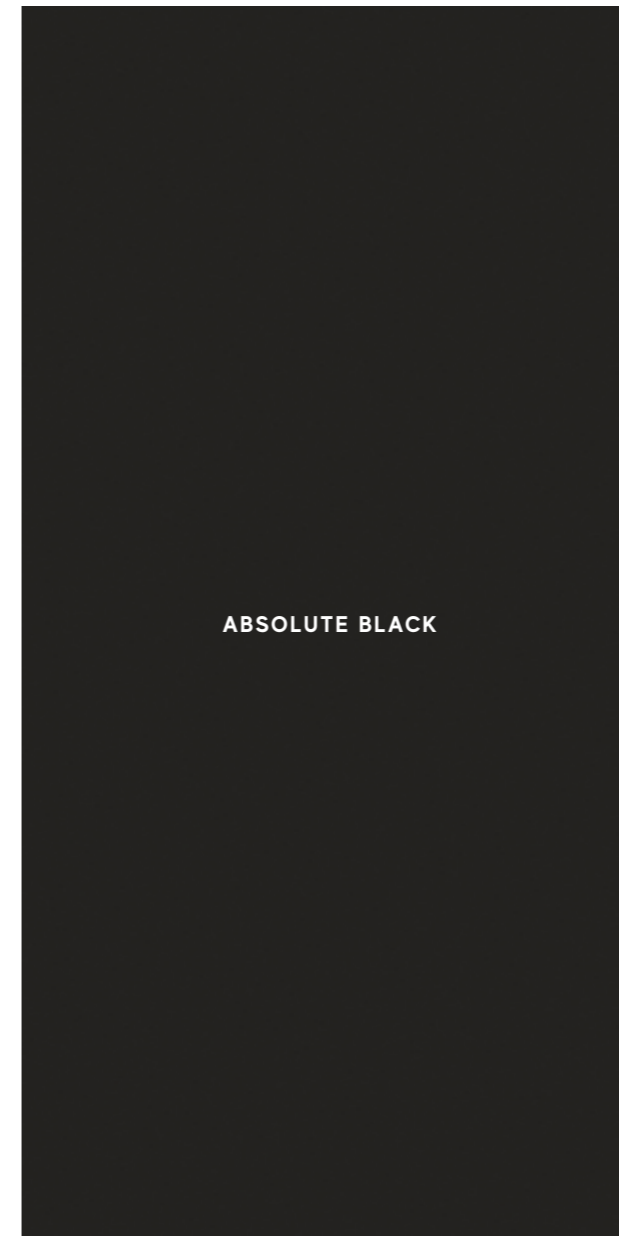

ABSOLUTE BLACK

Sizes	Thickness	Surface finish
162x324 cm - 63 ³ / ₄ "x127 ¹ / ₂ "	± 12 mm	Silk
> NON-RECTIFIED		

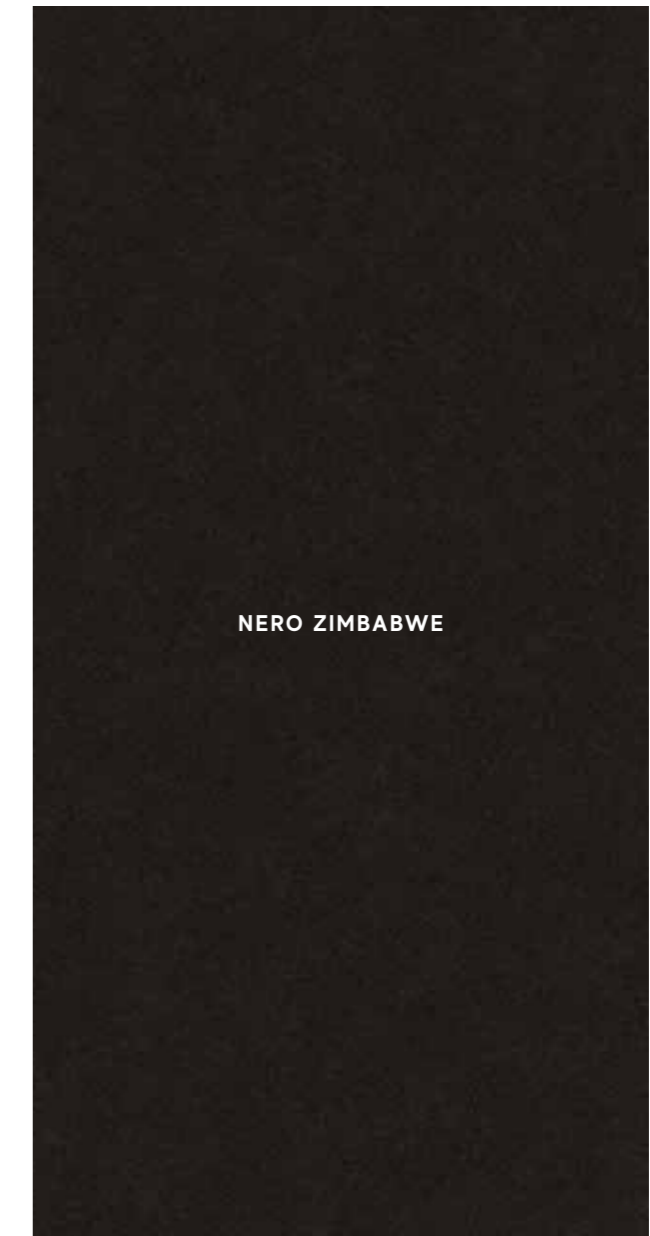

NERO ZIMBABWE

Sizes	Thickness	Surface finish
162x324 cm - 63 ³ / ₄ "x127 ¹ / ₂ "	± 6, 12, 20 mm	Flamed
> NON-RECTIFIED		

atlasPLAN SINGLE SLAB NON RECTIFIED
162x324 cm - 63³/₄"x127¹/₂"

AAV7 Concrete Grey Silk - 12mm ST *

atlasPLAN SINGLE SLAB NON RECTIFIED
162x324 cm - 63³/₄"x127¹/₂"

- ▼
- A07Z Absolute White Matt - 6mm ST *
- AMJ7 Absolute White Silk - 12mm ST *
- A4T4 Absolute White Polished - 12mm ST *
- A00B Absolute White Silk - 20mm
- A53S Absolute White Polished - 20mm

atlasPLAN SINGLE SLAB NON RECTIFIED
162x324 cm - 63³/₄"x127¹/₂"

▼
A23J Absolute Black Silk - 12mm ST *

atlasPLAN SINGLE SLAB NON RECTIFIED
162x324 cm - 63³/₄"x127¹/₂"

- ▼
- A2YE Nero Zimbabwe Flamed - 6mm ST *
- A0Y3 Nero Zimbabwe Flamed - 12mm ST *
- A2XQ Nero Zimbabwe Flamed - 20mm

XL Large Sizes

Glazed Porcelain Tiles / Gres Porcellanato Smaltato

COLOR & DECOR



Prism
CAMEL

Sizes 120x278 cm - 47 1/4"x109 1/2"
Thickness ± 6 mm
Surface finish Matte

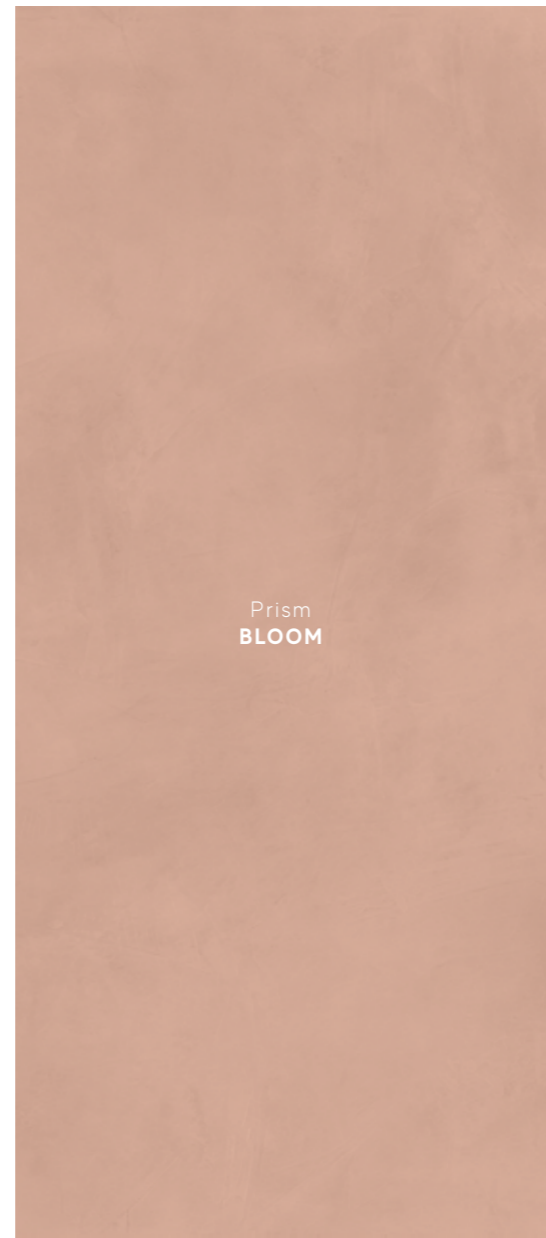

Prism
BLOOM

Sizes 120x278 cm - 47 1/4"x109 1/2"
Thickness ± 6 mm
Surface finish Matte



Prism
GRAPE

Sizes 120x278 cm - 47 1/4"x109 1/2"
Thickness ± 6 mm
Surface finish Matte



Prism
DUSK

Sizes 120x278 cm - 47 1/4"x109 1/2"
Thickness ± 6 mm
Surface finish Matte

XL Large Sizes

Glazed Porcelain Tiles / Gres Porcellanato Smaltato

COLOR & DECOR



Prism
MIDNIGHT

Sizes 120x278 cm - 47 1/4" x 109 1/2"
Thickness 6 mm
Surface finish Matte



Prism
MOSS

Sizes 120x278 cm - 47 1/4" x 109 1/2"
Thickness 6 mm
Surface finish Matte



Prism
EMERALD

Sizes 120x278 cm - 47 1/4" x 109 1/2"
Thickness 6 mm
Surface finish Matte



Prism
BRUSH

Sizes 120x278 cm - 47 1/4" x 109 1/2"
Thickness 6 mm
Surface finish Matte

GRAPHIC CONTINUITY ■ (SEE PAGE 553)



XL Large Sizes

Glazed Porcelain Tiles / Gres Porcellanato Smaltato

COLOR & DECOR

Porcelain Tiles / Gres Porcellanato



Prism
GRADIENT

Sizes 120x278 cm - 47 1/4"x109 1/2"
Thickness ± 6 mm
Surface finish Matte

GRAPHIC CONTINUITY ■ (SEE PAGE 553)

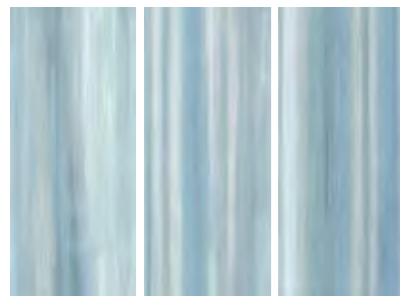

▼
A4VO Prism Gradient XL 120x278 ● (see page 553)



Boost Pro
LEAVES

Sizes 120x278 cm - 47 1/4"x109 1/2"
Thickness ± 6 mm
Surface finish Matte

GRAPHIC CONTINUITY



▼
A3HE Boost Pro Leaves 120x278 A ● (see page 553)
A3M2 Boost Pro Leaves 120x278 B ● (see page 553)

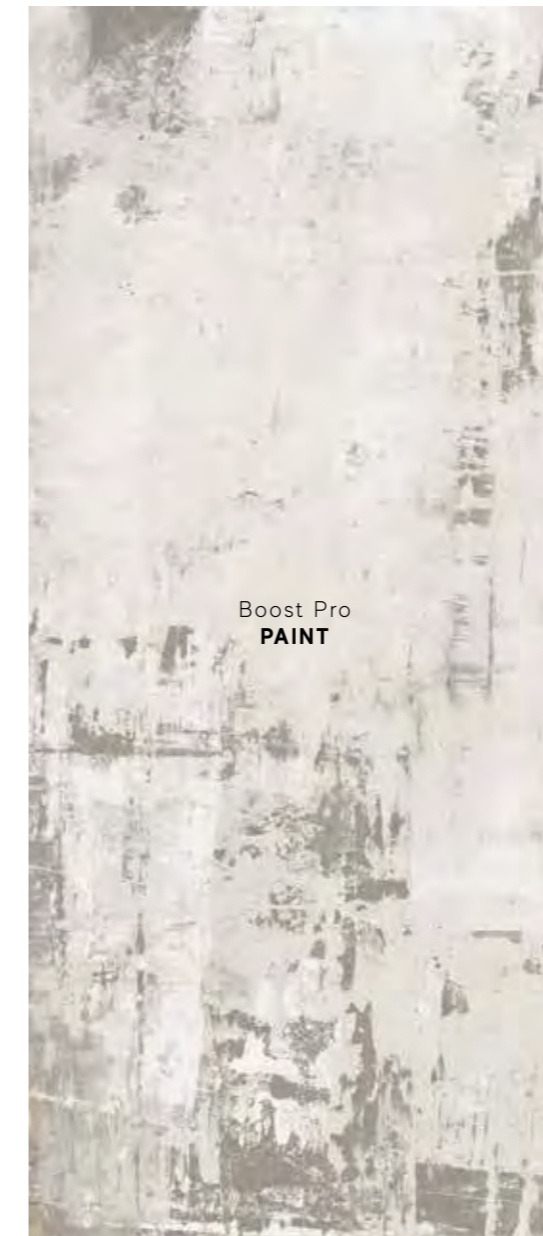

Boost Pro
PAINT

Sizes 120x278 cm - 47 1/4"x109 1/2"
Thickness ± 6 mm
Surface finish Matte

GRAPHIC CONTINUITY ■ (SEE PAGE 553)



▼
A0LX Boost Pro Paint 120x278



Boost Pro
GROVE

Sizes 120x278 cm - 47 1/4"x109 1/2"
Thickness ± 6 mm
Surface finish Matte

GRAPHIC CONTINUITY ■ (SEE PAGE 553)



▼
A0LW Boost Pro Grove 120x278

XL Large Sizes

Destinations of Use / Destinazione d'uso

Heavy commercial, medium commercial and residential. Commerciale pesante, commerciale medio e residenziale.			
AIX	Matte	± 9 mm	H R10 A+B
BLAZE	Matte	± 6 mm	M R9 A
	Matte	± 9 mm	H R10 A+B
BOOST	Matte	± 6 mm	M R9 A
	Matte	± 9 mm	H R10 A+B
BOOST PRO	Matte	± 6 mm	M R9 A
	Matte	± 9 mm	H R10 A+B
DWELL	Matte	± 9 mm	H R9 A
KONE	Matte	± 9 mm	H R10 A
LIMS	Matte	± 6 mm	M R9 A
	Matte	± 9 mm	H R10 A+B
MARVEL	Polished	± 6/9 mm	M
	Matte	± 6 mm	M R9 A
	Matte	± 9 mm	H R9 A
MARVEL DREAM	Polished	± 6/9 mm	M
	Matte	± 6 mm	M R9 A
	Matte	± 9 mm	H R9 A
	Matte Soft Touch * (60x60)	± 9 mm	H R10 A+B
MARVEL EDGE	Polished	± 6/9 mm	M
	Polished	± 6/9 mm	M
MARVEL PRO	Matte	± 6 mm	M R9 A
	Matte	± 9 mm	H R9 A
MARVEL SHINE	Polished	± 6/9 mm	M
	Silk	± 6 mm	M
	Matte	± 9 mm	H R10 A+B
MARVEL STONE (Marble look)	Matte	± 6 mm	M R9 A
	Matte	± 9 mm	H R9 A
MARVEL STONE (Stone look)	Matte	± 9 mm	H R9 A
PRISM	Matte Applies to / Valido per: Suede, Cord, Cotton, Cloud, Fog, Graphite	± 6 mm	M R9 A
	Matte	± 9 mm	H R10 A+B
RAW	Matte	± 6 mm	M R9 A
	Matte	± 9 mm	H R10 A+B

H

HEAVY TRAFFIC

Heavy commercial / Commerciali pesanti

Malls, airports, places of worship, schools, museums, squares, hospitals, hotels - foyers, undergrounds, train stations, etc.

Mall, aeroporti, luoghi di culto, scuole, musei, piazze, ospedali, hotel - hall di ingresso, metropolitana, stazioni ferroviarie, ecc...

M

MEDIUM TRAFFIC

Medium commercial / Commerciali medi

Restaurants, offices, shops, public restrooms, public offices, hotels except for foyers, business lounges, etc. with the exception of mandatory passageways and areas subject to the transit of trolleys with hard wheels or highly concentrated loads.

Ristoranti, uffici, negozi, bagni pubblici, uffici pubblici, hotel - ad esclusione delle hall di ingresso, business lounge, etc. a esclusione di passaggi obbligati e zone soggetto a transito di carrelli con ruote dure ovvero elevati carichi concentrati.

L

LIGHT TRAFFIC

Residential / Residenziali

Bedrooms, living rooms, studies, private kitchens, private bathrooms, etc..

Camere da letto, soggiorni, studi, cucine private, bagni privati...



✘ **WITH FIBERGLASS MESH I VERSIONE STUOIATA /**
Version à nattes / Ausführung mit Glasfasermatte / Versión con malla / C упрочнением из стекловолоконка

● **THE USE OF A COMMON MILD DETERGENT IS RECOMMENDED. AVOID USING ACIDIC OR ALKALINE PRODUCTS, WAXES, STEEL WOOL, OR ABRASIVES. /**
SI CONSIGLIA L'UTILIZZO DI UN COMUNE DETERGENTE NEUTRO. EVITARE L'UTILIZZO DI PRODOTTI ACIDI O ALCALINI, CERANTI, PAGLIETTE DI METALLO O ABRASIVE. /
Nous vous conseillons d'utiliser des détergents neutres courants. Éviter l'utilisation de cires et de produits acides ou alcalins, ainsi que les pailles métalliques ou abrasives. /
Es empfiehlt sich, ein haushaltsübliches, neutrales Reinigungsmittel zu verwenden. Saure oder alkalische Produkte, Wachs sowie Metallwolle- bzw. Scheuerschwämme sind zu vermeiden. /
Recomendamos utilizar un detergente neutro común. Hay que evitar el uso de productos ácidos o alcalinos, ceras y estropajos de metal o abrasivos. /
екомендуется чистить обычным нейтральным моющим средством. Не рекомендуется использовать кислотные, щелочные, восковые средства, а также металлические мочалки.

■ **THE PRODUCTION PROCESS DOES NOT GUARANTEE THE PRESENCE OF THE EXACT SEQUENCE OF THE GRAPHICS INSIDE THE PACKAGING. /**
IL PROCESSO PRODUTTIVO NON GARANTISCE LA PRESENZA DELL'ESATTA SEQUENZA DELLE GRAFICHE ALL'INTERNO DELL'IMBALLLO. /
Le processus de fabrication ne garantit pas la présence de la séquence exacte des graphismes à l'intérieur de l'emballage. /
Der Produktionsprozess garantiert nicht die exakte Sequenz der Grafiken in der Verpackung. /
El proceso de producción no garantiza la presencia de la secuencia exacta de los gráficos dentro del embalaje. /
Процесс производства не обеспечивает наличие точно совпадающих рисунков поверхности внутри упаковки.

▲ **ANY SMALL MISALIGNMENTS IN THE CONTINUITY OF THE GRAIN BETWEEN DIFFERENT GRAPHICS ARE AN INTRINSIC CHARACTERISTIC OF THIS TYPE OF PRODUCT. /**
EVENTUALI PICCOLI DISALLINEAMENTI NELLA CONTINUITÀ DELLE VENATURE TRA GRAFICHE DIVERSE SONO UNA CARATTERISTICA INTRINSECA DI QUESTA TIPOLOGIA DI PRODOTTO. /
Tout léger décalage dans la continuité du grain entre les différents graphismes est une caractéristique intrinsèque de ce type de produit. /
Etwasige kleine Abweichungen in der Kontinuität der Maserung zwischen verschiedenen Grafiken sind ein wesenseigenes Merkmal dieser Produkttypologie. /
Cualquier pequeño desalineamiento en la continuidad de las vetas entre los diferentes gráficos es una característica intrínseca de este tipo de producto. /
Небольшие несовпадения прожлок разных рисунков являются естественной характеристикой данного типа изделия.

☛ **THE DECORATION CAN ONLY BE LAID ON THE WALL. / IL DECORO SI PUÒ POSARE SOLO A RIVESTIMENTO. /**
Décor uniquement mural. / Das Dekor kann nur an der Wand verlegt werden. / La decoración se puede colocar únicamente en paredes. / Декор может быть уложен только на стену.

OUTDOOR DESIGN

OUTDOOR PAVING AND WET AREAS

COLOURED BODY PORCELAIN TILES - RECTIFIED MONOCALIBER
GRES PORCELLANATO COLORATO IN MASSA - RETTIFICATO MONOCALIBRO



atlas concorde

Porcelain Tiles / Gres Porcellanato

TEXTURED - GRIP SURFACE / SUPERFICIE STRUTTURATA - GRIP

STONE LOOK

± 9 mm



Sizes	Thickness	Surface finish
60x120 cm - 23 ⁵ / ₈ "x47 ¹ / ₄ " > Norde	± 9 mm	Grip
37,5x75 cm - 14 ³ / ₄ "x29 ¹ / ₂ " > Aix, Dolmen Pro, Klif, Lims	± 9 mm	Grip
30x60 cm - 11 ³ / ₄ "x23 ⁵ / ₈ " > Brave, Kone, Trust	± 9 mm	Grip
30x60 cm - 11 ³ / ₄ "x23 ⁵ / ₈ " > Marvel Stone, Norde*	± 9 mm	Textured, Roccia*
22,5x45,3 cm - 8 ⁷ / ₈ "x17 ³ / ₄ " > Not Rectified Aix, Dolmen Pro	± 9 mm	Textured
22,5x22,5 cm - 8 ⁷ / ₈ "x8 ⁷ / ₈ " > Not Rectified Aix, Dolmen Pro	± 9 mm	Textured



R11 A+B	R11 A+B+C	R12 A+B+C
KONE	AIX DOLMEN PRO KLIF LIMS MARVEL STONE NORDE	BRAVE TRUST NORDE



Porcelain Tiles / Gres Porcellanato

OUTDOOR PAVING / PAVIMENTI DA ESTERNO

STONE LOOK ± 20 mm - 30 mm



Sizes	Thickness	Surface finish
120x120 cm - 47 ¹ / ₄ "x47 ¹ / ₄ " > Aix, Brave	± 20 mm	Textured
60x120 cm - 23 ⁵ / ₈ "x47 ¹ / ₄ " > Brave, Dolmen Pro, Lims, Marvel Stone, Norde, Trust	± 20 mm	Textured
90x90 cm - 35 ³ / ₈ "x35 ³ / ₈ " > Klif	± 20 mm	Textured
80x80 cm - 31 ¹ / ₂ "x31 ¹ / ₂ " > Norde	± 20 mm	Textured
60x90 cm - 23 ⁵ / ₈ "x35 ³ / ₈ " > Aix, Norde	± 20 mm	Textured
45x90 cm - 17 ³ / ₄ "x35 ³ / ₈ " > Brave, Klif, Trust	± 20 mm	Textured
60x60 cm - 23 ⁵ / ₈ "x23 ⁵ / ₈ " > Aix, Brave, Klif, Kone, Lims, Norde, Seastone, Sunrock, Trust	± 20 mm	Textured
60x60 cm - 23 ⁵ / ₈ "x23 ⁵ / ₈ " > Trust	± 30 mm	Textured
30x60 cm - 11 ³ / ₄ "x23 ⁵ / ₈ " > Brave, Trust	± 20 mm	Textured
22,5x45,4 cm - 8 ⁷ / ₈ "x17 ³ / ₄ " > Not Rectified Aix, Dolmen Pro	± 20 mm	Textured
22,5x22,5 cm - 8 ⁷ / ₈ "x8 ⁷ / ₈ " > Not Rectified Aix, Dolmen Pro	± 20 mm	Textured

**R11
A+B+C**

AIX
BRAVE
DOLMEN PRO
KLIF
KONE
LIMS

MARVEL STONE
NORDE
SEASTONE
SUNROCK
TRUST

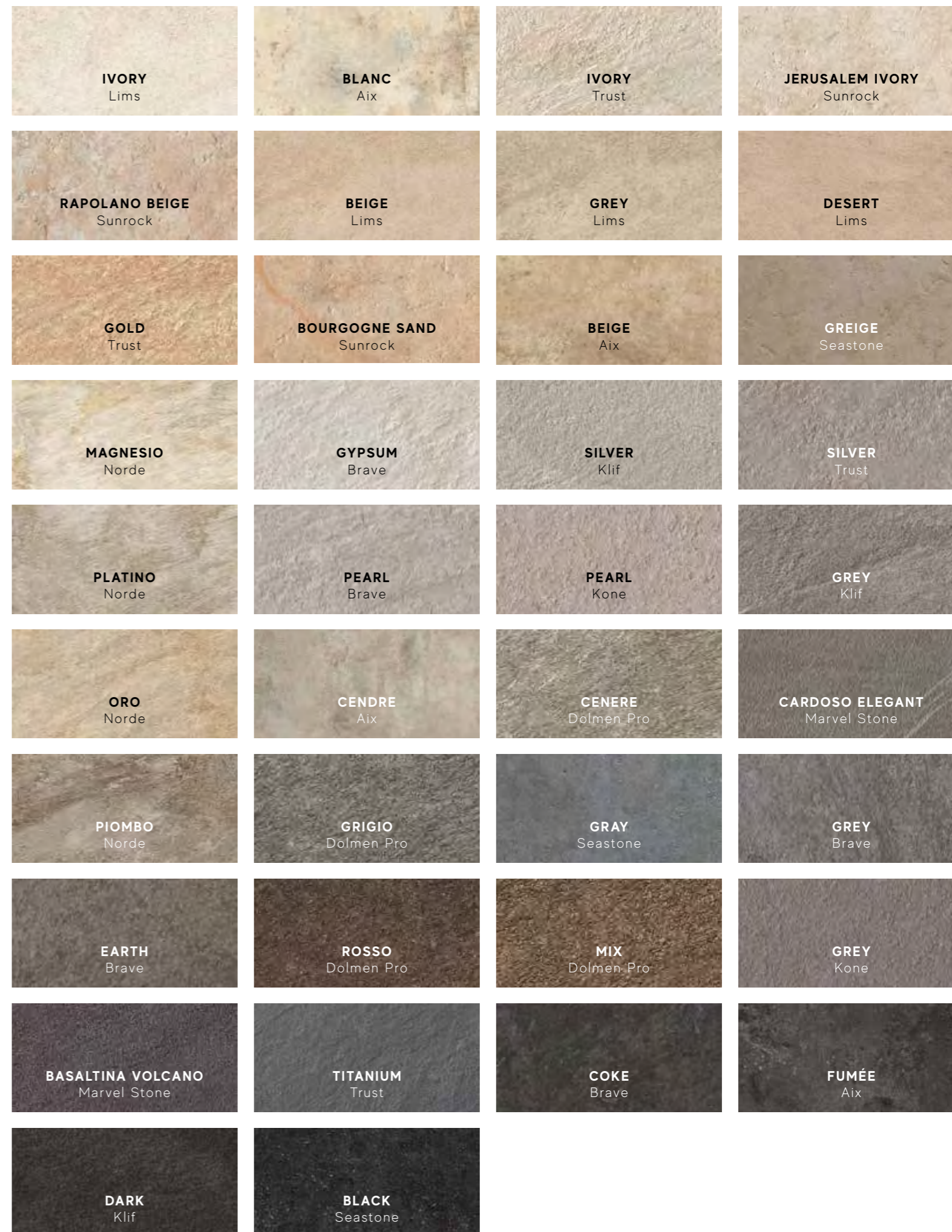

Porcelain Tiles / Gres Porcellanato

TEXTURED - GRIP SURFACE / SUPERFICIE STRUTTURATA - GRIP

WOOD LOOK

± 9 mm - 9,5 mm



Sizes	Thickness	Surface finish
18,5x150 cm - 7 ¹ / ₄ "x59" > Exence	± 9 mm	Grip
20x120 cm - 7 ⁷ / ₈ "x47 ¹ / ₄ " > Nash	± 9 mm	Grip
22,5x90 cm - 8 ⁷ / ₈ "x35 ³ / ₈ " > Axi	± 9,5 mm	Textured
22,5x90 cm - 8 ⁷ / ₈ "x35 ³ / ₈ " > Etic Pro	± 9 mm	Grip
15x90 cm - 5 ⁷ / ₈ "x35 ³ / ₈ " > Arbor	± 9 mm	Grip

OUTDOOR PAVING / PAVIMENTI DA ESTERNO

WOOD LOOK

± 20 mm



Sizes	Thickness	Surface finish
30x120 cm - 11 ³ / ₄ "x47 ¹ / ₄ " > Exence, Etic Pro	± 20 mm	Textured
45x90 cm - 17 ³ / ₄ "x35 ³ / ₈ " > Axi	± 20 mm	Textured
60x60 cm - 23 ⁵ / ₈ "x23 ⁵ / ₈ " > Axi	± 20 mm	Textured



R11
A+B+C
ARBOR
AXI
ETIC PRO
NASH
EXENCE

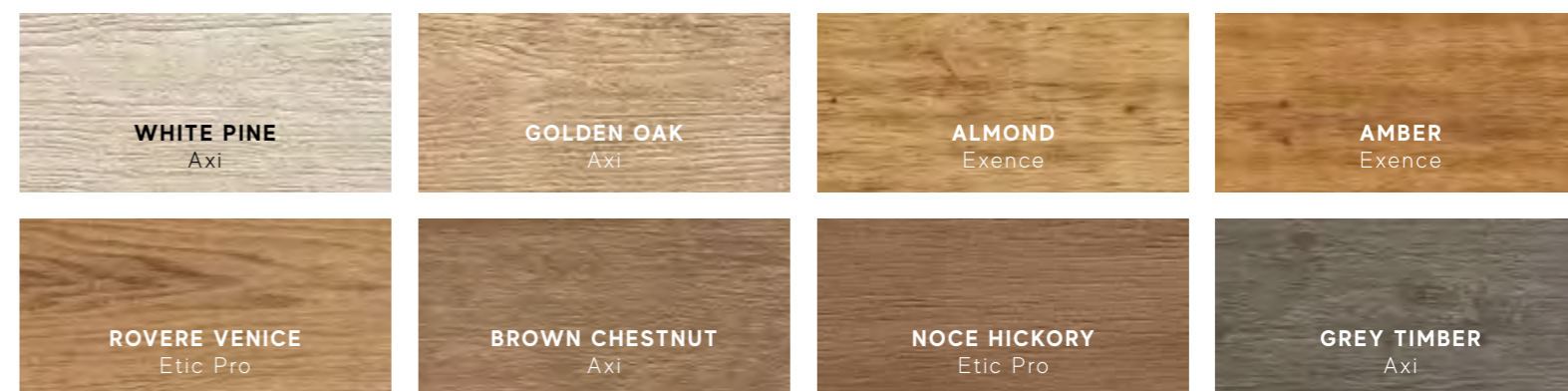
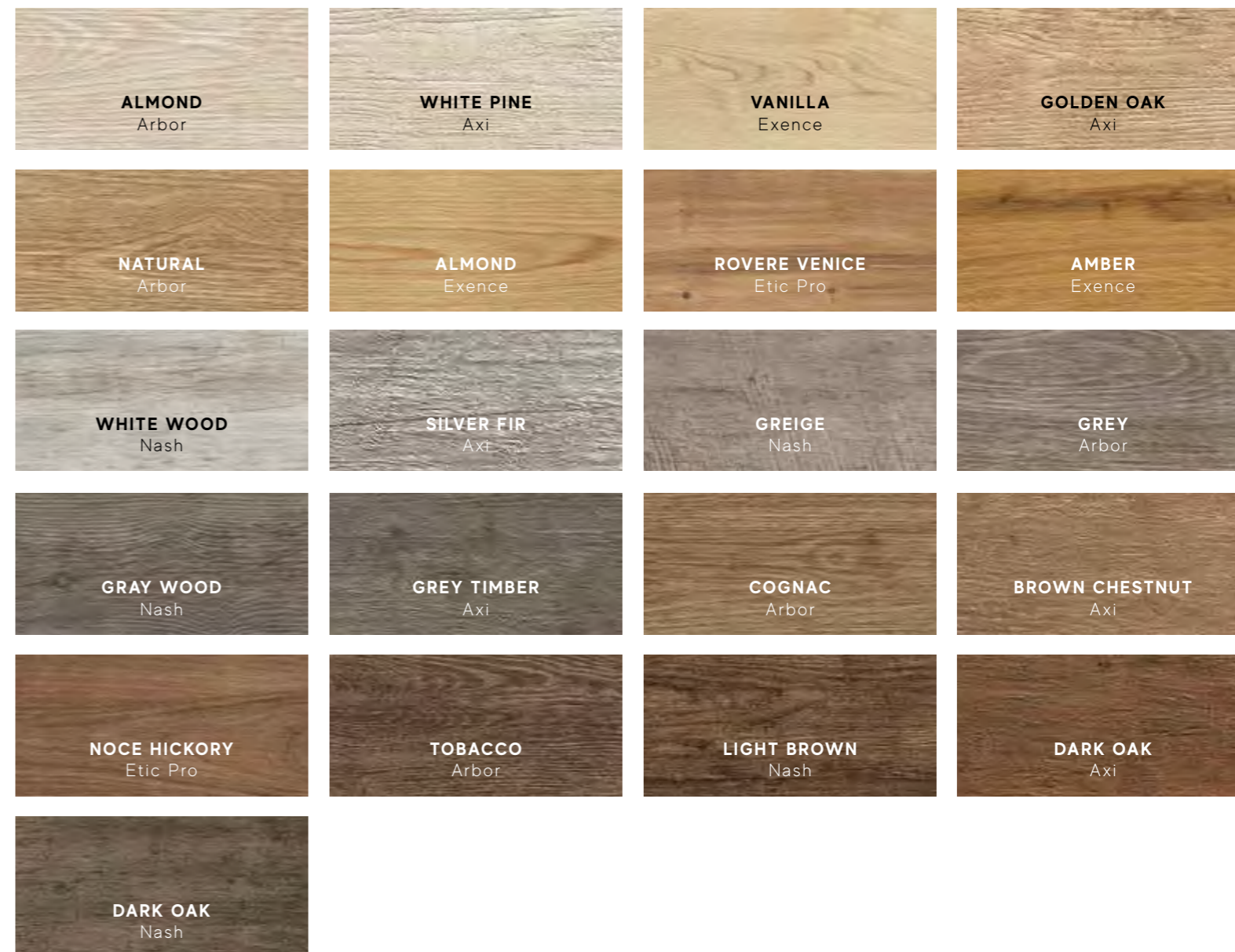

Porcelain Tiles / Gres Porcellanato

TEXTURED - GRIP SURFACE / SUPERFICIE STRUTTURATA - GRIP

CONCRETE LOOK

± 9 mm



Sizes	Thickness	Surface finish
120x120 cm - 47 ¹ / ₄ "x47 ¹ / ₄ " > Boost, Boost Pro, Prism	± 9 mm	Grip
37,5x75 cm - 14 ³ / ₄ "x29 ¹ / ₂ " > Raw	± 9 mm	Grip
30x60 cm - 11 ³ / ₄ "x23 ⁵ / ₈ " > Arkshade	± 9 mm	Grip

METAL LOOK

± 9 mm



Sizes	Thickness	Surface finish
37,5x75 cm - 14 ³ / ₄ "x29 ¹ / ₂ " > Blaze	± 9 mm	Grip

MARBLE LOOK

± 9 mm



Sizes	Thickness	Surface finish
30x60 cm - 11 ³ / ₄ "x23 ⁵ / ₈ " > Marvel Pro	± 9 mm	Textured



R11 A+B	R11 A+B+C
ARKSHADE MARVEL PRO	BLAZE BOOST BOOST PRO PRISM RAW

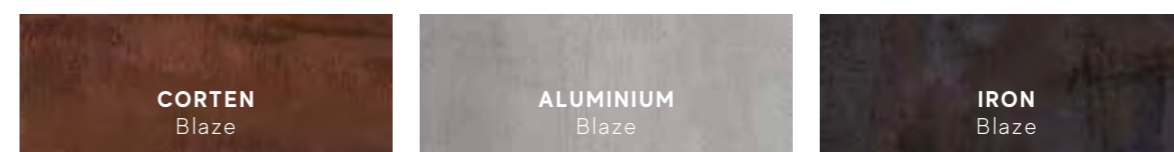
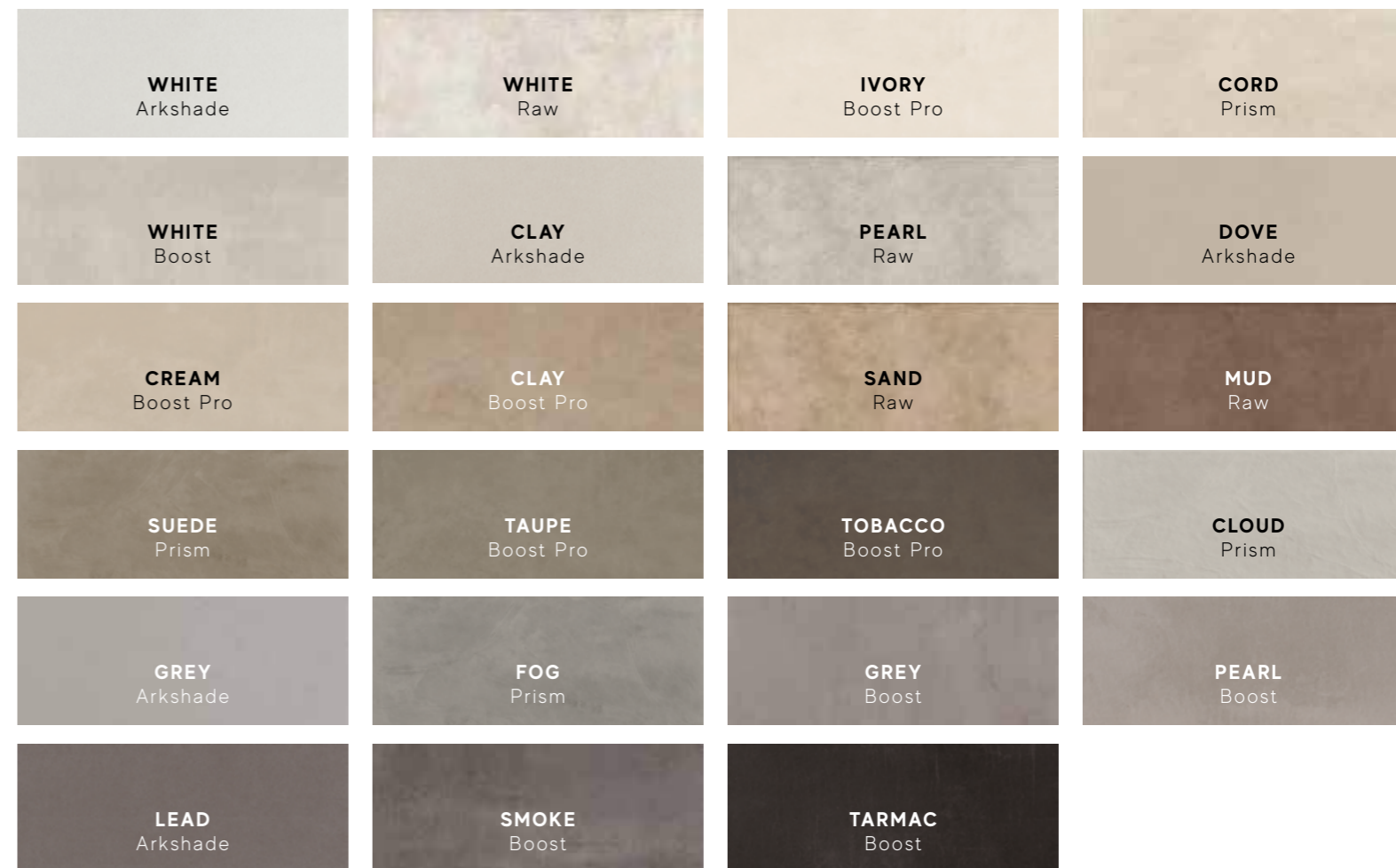

Porcelain Tiles / Gres Porcellanato

OUTDOOR PAVING / PAVIMENTI DA ESTERNO

CONCRETE LOOK

± 20 mm



Sizes	Thickness	Surface finish
120x240 cm - 47 ¹ / ₄ "x94 ¹ / ₂ " > Boost	± 20 mm	Textured
120x120 cm - 47 ¹ / ₄ "x47 ¹ / ₄ " > Boost, Boost Pro, Prism, Raw	± 20 mm	Textured
60x120 cm - 23 ⁵ / ₈ "x47 ¹ / ₄ " > Boost, Boost Pro, Raw	± 20 mm	Textured
90x90 cm - 35 ³ / ₈ "x35 ³ / ₈ " > Boost, Boost Pro, Dwell	± 20 mm	Textured
80x80 cm - 31 ¹ / ₂ "x31 ¹ / ₂ " > Prism	± 20 mm	Textured
60x60 cm - 23 ⁵ / ₈ "x23 ⁵ / ₈ " > Boost, Boost Pro	± 20 mm	Textured

METAL LOOK

± 20 mm



Sizes	Thickness	Surface finish
120x120 cm - 47 ¹ / ₄ "x47 ¹ / ₄ " > Blaze	± 20 mm	Textured
60x60 cm - 23 ⁵ / ₈ "x23 ⁵ / ₈ " > Blaze	± 20 mm	Textured



R11
A+B+C
BLAZE
BOOST
BOOST PRO
DWELL
PRISM
RAW

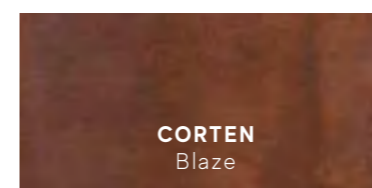
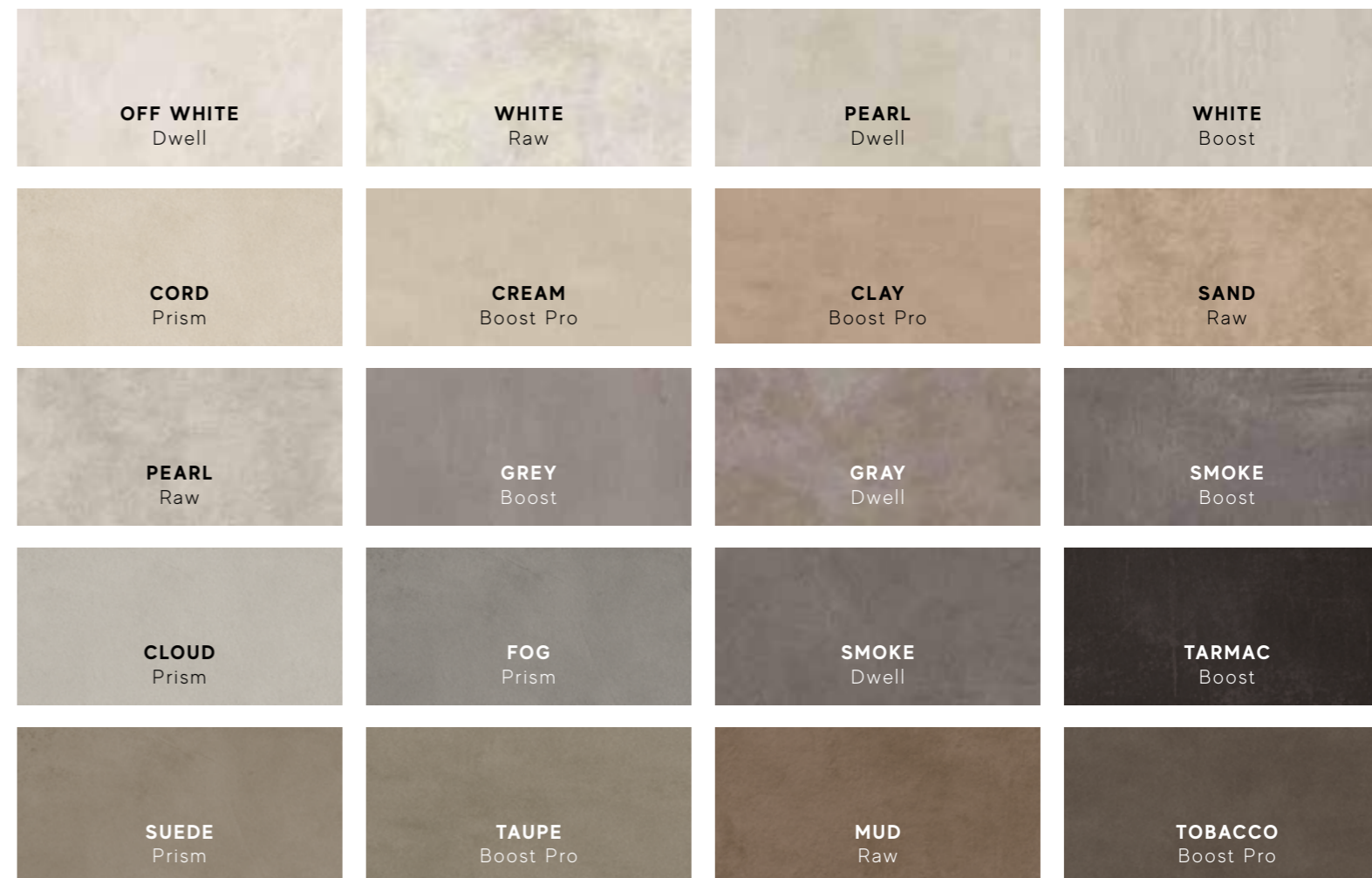

FOR FURTHER DETAILS ON THE 20MM THICK PRODUCTS, RELATED TRIM PIECES AND INSTALLATION SYSTEMS - IN PARTICULAR FOR RECOMMENDATIONS AND PRECAUTIONS DURING INSTALLATION- PLEASE REFER TO THE OUTDOOR DESIGN SECTION ON THE ATLAS CONCORDE WEBSITE OR TO THE OUTDOOR DESIGN CATALOGUE. / PER DETTAGLI SUL PRODOTTO E SUI RELATIVI PEZZI SPECIALI IN 20MM DI SPESSORE, PER I SISTEMI DI POSA E, IN PARTICOLARE, PER RACCOMANDAZIONI, ACCORGIMENTI E PRECAUZIONI IN FASE DI POSA E PROGETTAZIONE, SI RACCOMANDA DI PRENDERE VISIONE DEL CATALOGO OUTDOOR DESIGN E DELLA SEZIONE OUTDOOR DESIGN DEL SITO ATLAS CONCORDE. Pour plus de renseignements sur le produit, les pièces spéciales de 20mm d'épaisseur et sur les systèmes de pose, ainsi que pour tous conseils et recommandations et précautions d'emploi pendant la pose ou en phase de conception, nous vous recommandons de lire le catalogue Outdoor Design et de consulter la section Outdoor Design sur le site d'Atlas Concorde. / Bitte beachten Sie die detaillierten Informationen zum Produkt und zu den zugehörigen Formteilen in 20mm Stärke, zu den Verlegesystemen sowie vor allem die Empfehlungen, Tipps und bei der Planung und Verlegung zu beachtenden Vorsichtsmaßnahmen, die im Katalog Outdoor Design sowie im Bereich Outdoor Design der Atlas Concorde-Website aufgeführt sind. / Para mayor información sobre el producto y sus relativas piezas especiales de 20mm de grosor, para los sistemas de colocación, y en particular, para las recomendaciones, precauciones y precauciones en la fase de colocación y diseño, se recomienda consultar el catálogo Outdoor Design y la sección Outdoor Design del sitio Atlas Concorde. / Подробнее о плитках и о специальных элементах толщиной 20мм, о системах монтажа, о мерах предосторожности при проектировании и укладке можно узнать в каталоге Outdoor Design и в разделе Outdoor Design на сайте Atlas Concorde.

Porcelain Tiles / Gres Porcellanato

TRIM TILES / PEZZI SPECIALI

± 20 mm

	Lineare	Round	Round Angolare Dx/Sx	Round 60 Angolare Dx/Sx	Gradino Round Angolare Dx/Sx	Gradino Round	Elemento L Angolare	Elemento L Angolare Dx/Sx	Alzata	Top	Costa Design	Bordo Piscina Angolare Dx/Sx	Bordo Piscina	Griglia Angolare Dx/Sx	Griglia	Curve	Smussato
AIX		•	•	•	•	•	•	•	•	•	•	•	•	•	•	•	•
AXI	•	•	•	•	•	•	•	•	•	•	•	•	•	•	•	•	•
BLAZE		•	•	•	•	•	•	•	•	•	•	•	•	•	•	•	•
BOOST		•	•	•	•	•	•	•	•	•	•	•	•	•	•	•	•
BOOST PRO	•	•	•	•	•	•	•	•	•	•	•	•	•	•	•	•	•
BRAVE		•	•	•	•	•	•	•	•	•	•	•	•	•	•	•	•
DOLMEN PRO		•	•	•	•	•	•	•	•	•	•	•	•	•	•	•	•
DWELL			•	•	•	•	•	•	•	•	•	•	•	•	•	•	•
ETIC PRO		•	•	•	•	•	•	•	•	•	•	•	•	•	•	•	•
EXENCE		•	•	•	•	•	•	•	•	•	•	•	•	•	•	•	•
KLIF		•	•	•	•	•	•	•	•	•	•	•	•	•	•	•	•
KONE	•	•	•	•	•	•	•	•	•	•	•	•	•	•	•	•	•
LIMS	•	•	•	•	•	•	•	•	•	•	•	•	•	•	•	•	•
MARVEL STONE		•	•	•	•	•	•	•	•	•	•	•	•	•	•	•	•
NORDE	•	•	•	•	•	•	•	•	•	•	•	•	•	•	•	•	•
PRISM		•	•	•	•	•	•	•	•	•	•	•	•	•	•	•	•
RAW		•	•	•	•	•	•	•	•	•	•	•	•	•	•	•	•
TRUST		•	•	•	•	•	•	•	•	•	•	•	•	•	•	•	•

Technical Specifications / Specifiche Tecniche

INDOOR

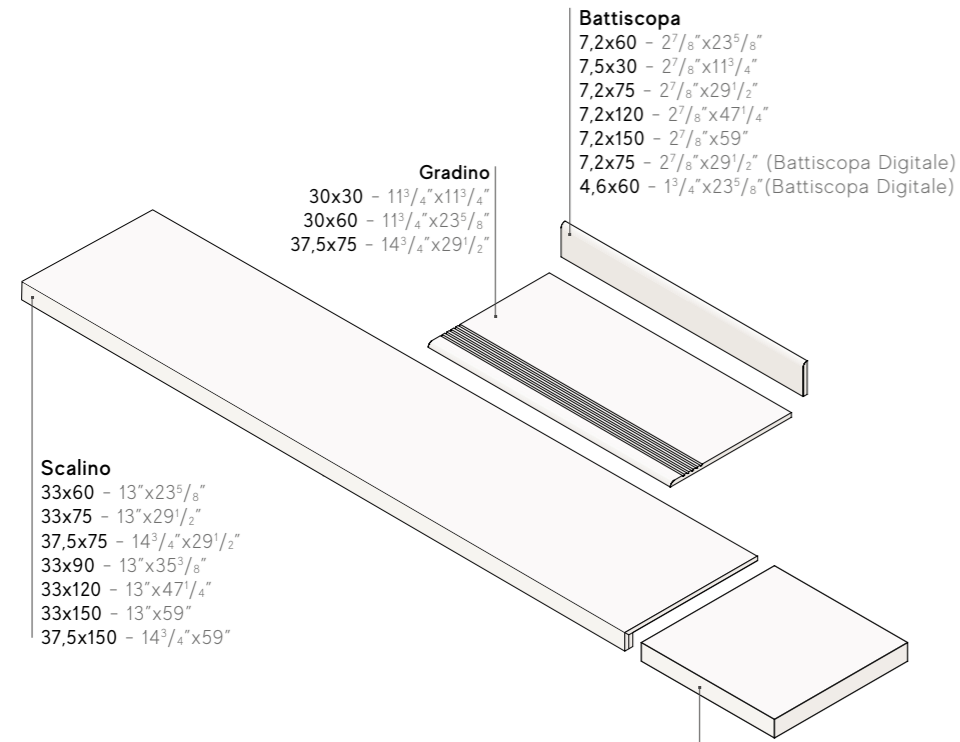

For the special pieces Granigliati see p. 496
 Per i pezzi Speciali Granigliati vedi p. 496
 Pour les pièces Spéciali Granigliati voir page 496
 Für die Formteile Granigliati siehe Seite 496
 Para las piezas especiales Granitos, consultar la pág. 496
 Специальные элементы Granigliati см. на стр. 496

Scalino Angolare
 33x33 - 13"x13"
 37,5x37,5 - 14³/₄"x14³/₄"

OUTDOOR

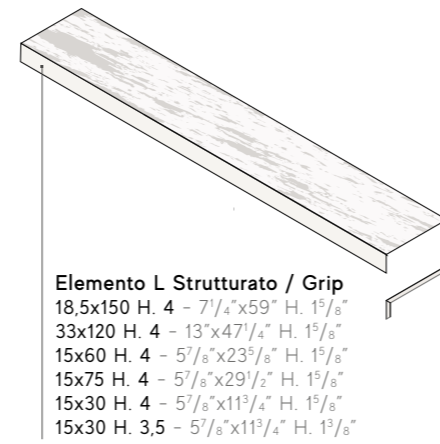

Battiscopa Sagomato

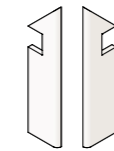

Battiscopa Sag. Scala Dx / Sx
 7,5x30 - 3"x11³/₄"
 7,2x30 - 2⁷/₈"x11³/₄"

TRIM TILES / PEZZI SPECIALI ± 20 mm

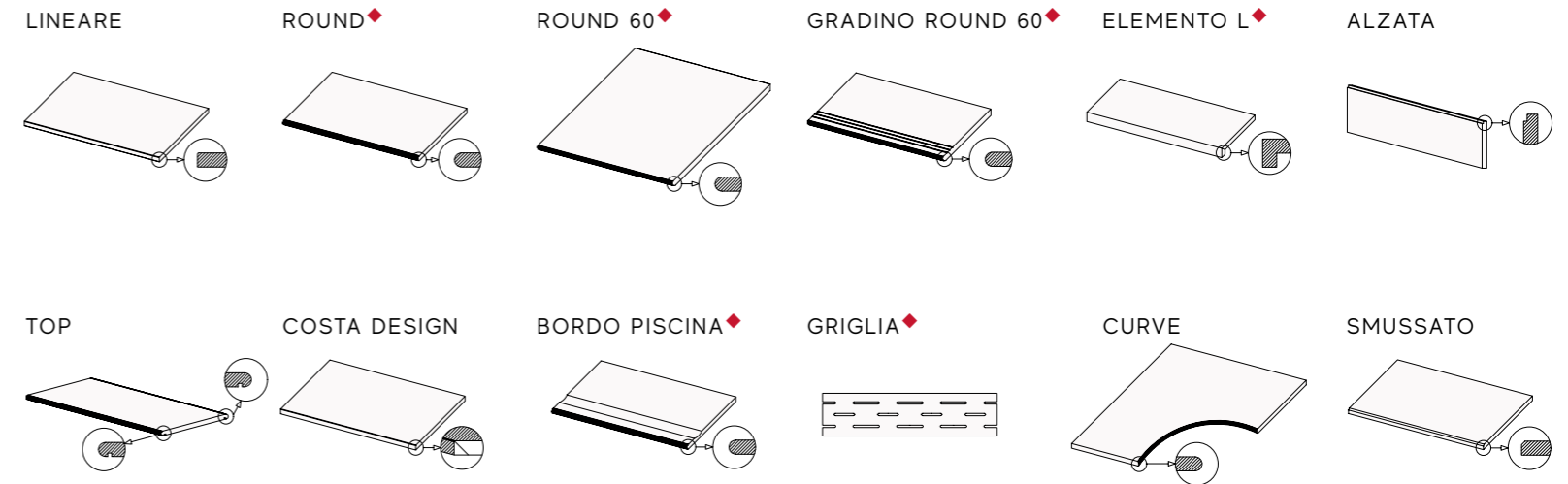

◆ Right/left angular elements are available / Sono disponibili gli elementi angolari dx/sx



WOOD LOOK

INDOOR

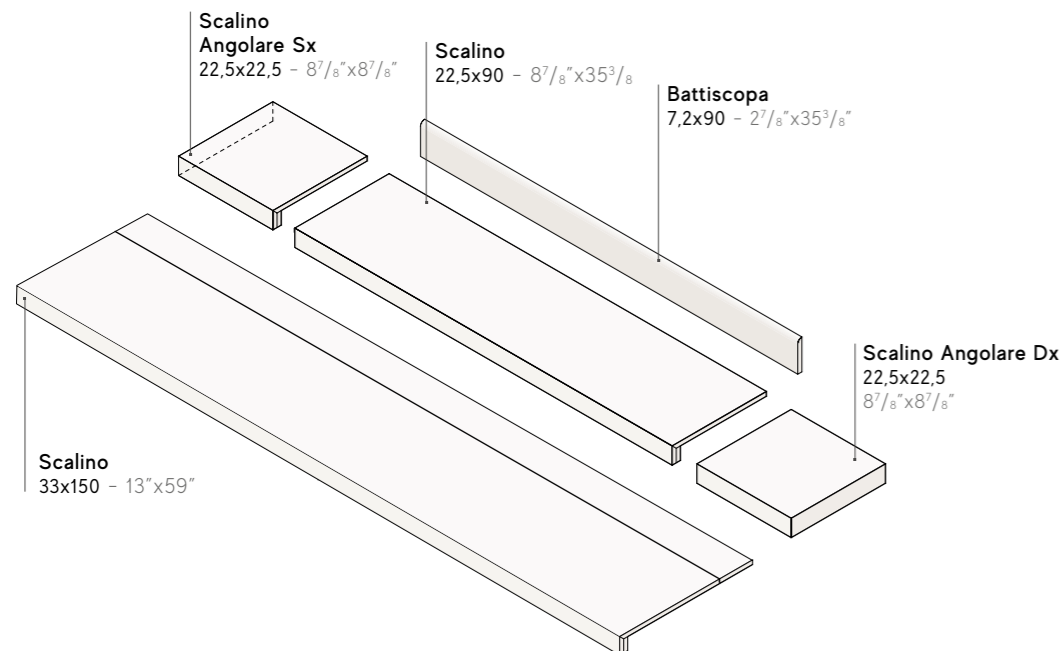

OUTDOOR

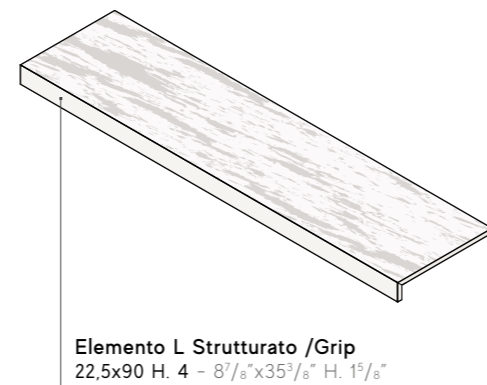

TRIM TILES / PEZZI SPECIALI ± 9 mm - 9,5 mm

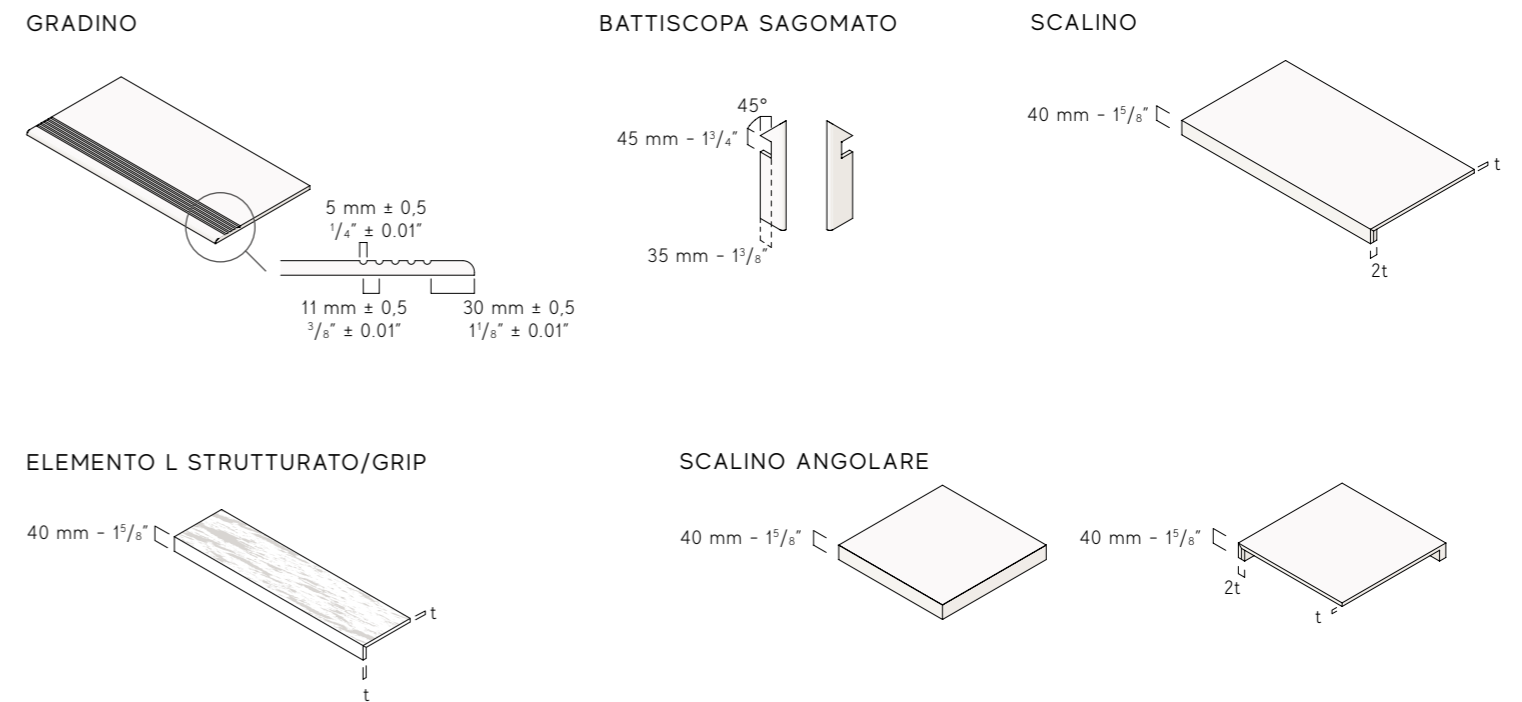

t = thickness



Technical Specifications

- 574 GREEN PROJECT
- 575 V-SHADE, COLOUR-SHADING
- 576 SIZES RANGE
- 580 PORCELAIN TILES TECHNICAL SPECIFICATIONS
- 595 UPEC CERTIFICATION
- 596 DESTINATIONS OF USE
- 598 PORCELAIN TILES FOR OUTDOORS
- 600 ANTI-SLIP CLASSIFICATION
- 602 WALL TILES TECHNICAL SPECIFICATIONS
- 606 LAYING SUGGESTIONS
- 618 GENERAL PACKING AND WEIGHT
- 622 GENERAL SALES CONDITIONS

PORCELAIN AND WALL TILES: A SAFE CHOICE / LA CERAMICA: UNA SCELTA SICURA

Résistance et longévité / Widerstandsfähigkeit und lebensdauer / Resistencia y durabilidad / Стойкость и долговечность

Easy to maintain / Facile da manuteneere / Entretien facile / Leicht zu warten / Fácil de mantener / Простота ухода

Porcelain tiles do not require any special maintenance. / Il gres porcellanato non richiede manutenzioni particolari. / Le grès cérame n'exige aucun entretien particulier. / Feinsteinzeug erfordert keine besonderen Wartungsarbeiten. / El gres porcelánico no requiere particulares operaciones de mantenimiento. / Керамогранит не нуждается в особом уходе.

UV Resistant / Resistente ai raggi UV / Résistant aux rayons uv / UV-Strahlenfest / Resistente a los rayos UV / Стойкость к уф-излучению

Porcelain tiles maintain their colors even when exposed to continuous, direct sunlight or in contact with atmospheric agents or smog. / Il gres porcellanato rimane inalterato nei suoi colori anche se esposto alla luce diretta e continua del sole o a contatto con agenti atmosferici o smog. / Les coloris du grès cérame restent inaltérés même s'il est exposé à la lumière directe et continue du soleil ou au contact du smog et des agents atmosphériques. / Die Farben des Feinsteinzeugs bleiben unverändert erhalten, auch wenn es direktem und ständigem Sonnenlicht, der Witterung oder Smog ausgesetzt ist. / El gres porcelánico no se altera con el paso del tiempo, tampoco cambia su color cuando está expuesto a la luz directa y continua del sol o cuando entra en contacto con agentes climatológicos o contaminación. / Керамогранит не выцветает даже при постоянном воздействии солнечного света, атмосферных факторов, смога.

Scratch resistant / Résistant aux rayures / Kratzfestigkeit / Resistente a las rayas / Стойкость к царапинам

Porcelain tiles do not splinter, break or get damaged. / Il gres porcellanato non scheggia, non si rompe e non si danneggia. / Le grès cérame ne subit ni ébréchures, ni cassures, ni dommages. / Feinsteinzeug splittert nicht, es zerbricht nicht und erleidet keine Beschädigungen. / El gres porcelánico no se desportilla, no se rompe y no se estropea. / Керамогранит не раскалывается, не ломается, не повреждается.

Easy to clean / Facile da pulire / Facile à nettoyer / Leicht zu reinigen / De fácil limpieza / Легкость чистки

Porcelain tiles are easy to clean. / Il gres porcellanato si pulisce facilmente. / Le grès cérame se nettoie facilement. / Feinsteinzeug kann leicht gereinigt werden. / El gres porcelánico se limpia fácilmente. / Керамогранит легко очищается.

Stain resistant / Resistente alle macchie / résistant aux taches / Fleckenfestigkeit / Resistente a las manchas / Стойкость к пятнам

Porcelain tiles are waterproof, no liquid can damage the surface. / Il gres porcellanato è impermeabile e nessun tipo di liquido può danneggiarne la superficie. / Le grès cérame est imperméable et aucun type de liquide ne peut endommager sa surface. / Feinsteinzeug ist wasserundurchlässig und Flüssigkeiten jeglicher Art können seine Oberfläche nicht beschädigen. / El gres porcelánico es impermeable y ningún tipo de liquido puede estropear la superficie. / Керамогранит непроницаем, и никакая жидкость не может повредить его поверхность.

Resistant to chemicals / Resistente agli agenti chimici / Résistant aux agents chimiques / Beständigkeit gegen chemikalien / Resistente a los agentes químicos / Стойкость к химическим веществам

Porcelain tiles do not stain and resist the most aggressive chemical agents. / Il gres porcellanato non si macchia e resiste agli agenti chimici più aggressivi. / Le grès cérame ne se tache pas et résiste aux agents chimiques les plus agressifs. / Feinsteinzeug ist fleckenfest und beständig gegen die aggressivsten Chemikalien. / El gres porcelánico no se mancha y es resistente a los agentes químicos más agresivos. / Даже самые агрессивные химикаты не повреждают керамогранит и не оставляют на нем пятен.

Resistant to acids / Resistente agli acidi / résistant aux acides / Beständigkeit gegen säuren / Resistente a los ácidos / Стойкость к кислотам

Porcelain tiles are resistant to acids found in food and cleaning products. / Il gres porcellanato resiste agli acidi di uso alimentare e domestico. / Le grès cérame résiste aux acides d'usage alimentaire et domestique. / Feinsteinzeug ist beständig gegen Säuren, die in Nahrungsmitteln oder im Haushalt verwendet werden. / El gres porcelánico es resistente a los ácidos de uso alimenticio y doméstico. / Керамогранит устойчив к кислотам, входящим в состав пищевых продуктов и средств бытовой химии.

Resistant to thermal shock / Resistente agli shock termici / résistant aux écarts thermiques / Beständigkeit gegen thermoschocks / Resistente a los choques térmicos / Стойкость к перепадам температур

A porcelain tile floor will not change as a result of sharp temperature fluctuations. / Un pavimento in gres porcellanato non si altera a causa di sbalzi termici. / Un sol en grès cérame ne subit aucune altération suite aux écarts thermiques. / Ein Feinsteinzeug-Fußboden wird von Temperaturschwankungen nicht beeinträchtigt. / El pavimento de gres porcelánico no cambia a causa de cambios bruscos de temperatura. / Напольные покрытия из керамогранита не разрушаются при перепадах температур.

Waterproof / Resistente all'acqua / Résistant à l'eau / Wasserfestigkeit / Resistente al agua / Стойкость к воде

Porcelain tiles are completely non-porous and therefore are not damaged by water or humidity. / Il gres porcellanato è completamente non poroso e non teme l'acqua e l'umidità. / Le grès cérame est absolument non poreux et ne craint ni l'eau ni l'humidité. / Feinsteinzeug ist absolut porös und fürchtet weder Wasser noch Feuchtigkeit. / El gres porcelánico no es poroso, no le penetra el agua y es resistente a la humedad. / Керамогранит – абсолютно непористый материал, поэтому не боится воды и влаги.

Frost resistant / Resistente al ghiaccio / Résistant au gel /Frostbeständigkeit / Resistente a las heladas / Стойкость к морозам

Porcelain tiles are frost resistant and therefore are not damaged by low temperatures. / Il gres porcellanato è ingelivo e resiste alle temperature più basse. / Le grès cérame est ingélif et résiste aux températures les plus basses. / Feinsteinzeug ist frostbeständig und widersteht den niedrigsten Temperaturen. / El gres porcelánico es resistente a las heladas y a las bajas temperaturas. / Керамогранит способен противостоять морозам и низким температурам.

Santé / Gesundheit / Salud / Здоровье

Zero allergens / Zero allergeni / Zéro allergène / Null allergene / Cero alérgenos / Ноль аллергенов

Porcelain tiles are inhospitable for mites, bacteria, fungi, molds, and other irritants. / Il gres porcellanato è inospitale per acari, batteri, funghi, muffe e altre sostanze irritanti. / Le grès cérame est inhospitalier vis-à-vis des acariens, bactéries, champignons, moisissures et autres substances irritantes. / Feinsteinzeug ist ungastlich für Milben, Bakterien, Pilze, Schimmel und andere Reizstoffe. / El gres porcelánico es inhóspito para los ácaros, bacterias, hongos, mohos y otras sustancias irritantes. / На поверхности керамогранита не накапливаются клещи, бактерии, грибки, плесень и другие болезнетворные микроорганизмы.

Zero VOCs / Zero VOC / Zéro cov / Null VOC / Cero VOC / Ноль летучих органических соединений

Porcelain tiles are intrinsically inorganic and do not emit volatile organic compounds (VOCs). / Le piastrelle in gres porcellanato sono intrinsecamente inorganiche e non emettono composti organici volatili. / Les carreaux en grès cérame sont intrinsèquement inorganiques et ne libèrent aucun composé organique volatil. / Feinsteinzeugfliesen sind von Natur aus anorganisch und setzen keine flüchtigen organischen Verbindungen frei. / Las baldosas de gres porcelánico son intrínsecamente inorgánicas y no emiten compuestos orgánicos volátiles. / Керамогранит является неорганическим материалом и не выделяет летучих органических соединений.

Zero formaldehyde / Zero formaldeide / Zéro formaldéhyde / Null formaldehyd / Cero formaldehído / Ноль формальдегида

Porcelain tiles do not contain formaldehyde. / Il gres porcellanato non contiene formaldeide. / Le grès cérame ne contient pas de formaldéhyde. / Feinsteinzeug ist formaldehydfrei. / El gres porcelánico non contiene formaldehído. / Керамогранит не содержит формальдегид.

Zero PVC / Zero PVC / Zéro pvc / Null PVC / Cero PVC / Ноль пвх

Porcelain tiles contain no PVC, plastics or petroleum derivatives. / Il gres porcellanato è privo di PVC, plastiche o derivati del petrolio. / Le grès cérame est privé de PVC, de matières plastiques et de dérivés du pétrole. / Feinsteinzeug ist frei von PVC, Kunststoffen oder Petroleumderivaten. / El gres porcelánico no contiene PVC, plástico o sustancias que derivan del petróleo. / Керамогранит не содержит ПВХ, пластиковых материалов, нефтепродуктов.

Prevent bacterial growth / Previene la crescita batterica / Il prévient la croissance bactérienne / Vorbeugung gegen das wachstum von bakterien / Previene la proliferación de bacterias / Предотвращение развития бактерий

Porcelain tiles are completely hygienic and inhospitable for bacteria, mites, molds, and fungi. / Il gres porcellanato è assolutamente Il igienico e inospitale per i batteri, acari, muffe e funghi. / Le grès cérame est absolument hygiénique et inhospitalier vis-à-vis des bactéries, acariens, moisissures et champignons. / Feinsteinzeug ist absolut hygienisch und ungastlich für Bakterien, Milben, Schimmel und Pilze. / El gres porcelánico es totalmente higiénico e inhóspito para las bacterias, ácaros, mohos y hongos. / Керамогранит абсолютно гигиеничен и препятствует развитию бактерий, клещей, плесени, грибка.

Sécurité / Sicherheit / Seguridad / Безопасность

Non-slip / Antiscivolo / Antiglisse / Rutschfestigkeit / Antideslizante / Препятствование скольжению

Porcelain tile surfaces can be made with an abrasive surface grit that can increase traction and reduce the risk of slipping. / Le superfici in gres porcellanato possono essere realizzate con una graniglia abrasiva superficiale in grado di aumentare la trazione e ridurre i rischi di scivolamento. / Les surfaces en grès cérame peuvent être réalisées avec un fond superficiel abrasif en mesure daugmenter la traction et réduire le risque de glissade. / Die Oberflächen des Feinsteinzeugs können mit die Reibung erhöhenden Splitten bereichert werden, welche die Trittsicherheit verbessern und die Gefahr von Austrutschern mindern. / Las superficies de gres porcelánico se fabrican con una granalla abrasiva superficial en grado de aumentar la tracción y reducir los riesgos de deslizamiento. / На поверхность керамогранитной плитки в процессе изготовления может наноситься специальная абразивная крошка, которая увеличивает сцепление и снижает риск скольжения.

Fire resistant / Resistente al fuoco / Résistant au feu / Feuerfestigkeit / Resistente al fuego / Огнестойкость

Porcelain tiles are not flammable, reduce the spread of flames, do not burn, and do not emit toxic fumes. / Le piastrelle in gres porcellanato non sono infiammabili, riducono la propagazione della fiamma, non bruciano e non emettono fumi tossici. / Les carreaux en grès cérame sont ininflammables, ils réduisent la propagation de la flamme, ne brûlent pas et de libèrent aucune fumée toxique. / Feinsteinzfliessen sind nicht entflammbar, sie mindern die Flammenausbreitung, brennen nicht und setzen keinen toxischen Rauch frei. / Las baldosas de gres porcelánico no son inflamables, reducen la propagación de las llamas, son resistentes al fuego y no emiten humos tóxicos. / Керамогранитная плитка не воспламеняется, ограничивает распространение огня, не горит, не выделяет токсичного дыма.

Heat resistant / Resistente al calore / Résistant à la chaleur / Wärmebeständigkeit / Resistente al calor / Термостойкость

Porcelain tiles do not change shape at high temperatures. / Il gres porcellanato non si altera alle alte temperature. / Le grès ne subit aucune altération aux températures élevées. / Feinsteinzeug wird von hohen Temperaturen nicht verändert. / El gres porcelánico no se altera con las altas temperaturas. / Керамогранит не повреждается под действием высоких температур.

Environnement / Umwelt / Ambiente / Окружающая среда

Energy efficiency / Efficienza energetica / Efficacité énergétique / Energieeffizienz / Eficiencia energética / Энергоэффективность

The high thermal inertia of porcelain tiles moderates the changes in temperature of the rooms, favoring energy savings. / L'elevata inerzia termica del gres porcellanato modera gli sbalzi di temperatura degli ambienti, favorendo il risparmio energetico. / La haute inertie thermique du grès cérame modère les écarts de température à l'intérieur des pièces, en favorisant ainsi les économies d'énergie. / Die hohe Wärmeträgheit des Feinsteinzeugs reduziert starke Temperaturschwankungen in den Räumen und ermöglicht demzufolge eine Energieeinsparung. / La elevada inercia térmica del gres porcelánico modera los cambios de temperatura de los ambientes, favoreciendo el ahorro energético. / Высокая тепловая инерция керамогранита сглаживает колебания температуры в помещениях, что позволяет значительно экономить энергию.

Ecological / Ecologico / Écologique / Ökologisch / Ecológico / Экологичность

Porcelain tiles have a low environmental impact at all stages of their production, from the raw materials to disposal and recycling. / Il gres porcellanato ha un basso impatto ambientale in tutte le fasi del suo processo industriale, dalle materie prime fino allo smaltimento e al riciclo. / Le grès cérame a un faible impact sur l'environnement durant toutes les phases de son processus industriel, à partir des matières premières jusqu'à l'élimination et au recyclage. / In allen Phasen seines Herstellungsprozesses verursacht das Feinsteinzeug eine geringfügige Umweltbelastung, angefangen beim Abbau der Rohstoffe bis zur Entsorgung und zum Recycling. / El gres porcelánico tiene un bajo impacto ambiental en todas las fases de su proceso industrial, dese las materias primas hasta la eliminación y el reciclaje. / Керамогранит имеет низкое воздействие на окружающую среду на всем протяжении жизненного цикла: от добычи сырья до переработки и утилизации.

Recycling and re-use / Riciclo e riutilizzo / Recyclage et réutilisation / Recykling und wiederverwertung / Reciclaje y reutilización / Переработка и утилизация

Porcelain tiles are made with recycled materials, last a long time, and can be re-used because they retain their original appearance. / Il gres porcellanato è realizzato con materiali di riciclo, dura a lungo e mantenendo l'aspetto originario può essere riciclato. / Le grès cérame est fabriqué avec des matériaux de recyclage, il dure longtemps en maintenant son aspect d'origine et il est recyclable. / Feinsteinzeug wird aus Recycling-Material hergestellt, hat eine lange Lebensdauer, erhält sein ursprüngliches Aussehen und kann recycelt werden. / El gres porcelánico está fabricado con materiales de reciclado, es duradero al paso del tiempo y se puede reciclar manteniendo el aspecto original. / Керамогранит изготавливается из переработанных материалов, долговечен, сохраняет во времени свои первоначальные характеристики и поддается переработке.

Ideal for floor heating systems / Ideale per sistemi di riscaldamento a pavimento / Idéal pour les systèmes de chauffage au sol / Ideal für fußbodenheizsysteme / Indicado para los sistemas de calefacción por suelo radiante / Идеальное решение для теплого пола

Porcelain tiles can be effectively combined with floor heating systems. / Il gres porcellanato può essere abbinato in modo efficace a sistemi di riscaldamento a pavimento. / Le grès cérame peut être associé de manière efficace à des systèmes de chauffage au sol. / Feinsteinzeug ist optimal leistungsfähig in Verbindung mit Fußbodenheizsystemen. / El gres porcelánico se puede utilizar eficazmente con sistemas de calefacción por suelo radiante. / Керамогранит отлично подходит для облицовки полов с подогревом.

WALL TILES ADDITIONAL BENEFITS / PROPRIETÀ CERAMICA DA RIVESTIMENTO / PROPRIETÉS DE LA CÉRAMIQUE POUR REVÊTEMENTS / EIGENSCHAFTEN DER WANDFLIESEN / CARACTERÍSTICAS Y BENEFICIOS DE LA CERÁMICA PARA REVESTIMIENTO / СВОЙСТВА КЕРАМИЧЕСКОЙ ПЛИТКИ

While porcelain tiles are ideal for use on the floor thanks to their hardness and extreme durability, the light weight and workability of white body tiles make them ideal for use on walls: cuts and holes can be made quickly and easily, reducing installation time and costs. / Mentre il gres porcellanato è ideale per l'uso a pavimento, per la sua durezza e l'estrema resistenza, le caratteristiche di leggerezza e lavorabilità del rivestimento in pasta bianca lo rendono ideale per l'uso a parete: i tagli e i fori saranno eseguiti facilmente e velocemente, riducendo i tempi e i costi di posa. / Tandis que le grès cérame est idéal pour l'usage au sol en raison de sa dureté et de son extrême résistance, les caractéristiques de légèreté et d'usinabilité des carreaux en pâte blanche en font l'idéal pour l'usage mural : les découpes et les perçages s'effectuent facilement et rapidement, en réduisant les temps et les coûts de la pose. / Während das Feinsteinzeug dank seiner Härte und extremen Widerstandsfähigkeit ideal für die Fußbodenverlegung ist, machen die Leichtigkeit und die Verarbeitungsfreundlichkeit der weißscherbigen Wandbeläge diese ideal für Wandverlegungen: Schnitte und Bohrungen werden leicht und schnell ausgeführt, wodurch die Verlegungszeiten und -kosten sich verringern. / Si bien el gres porcelánico es indicado para su uso en pavimentos, por su dureza y máxima resistencia, el revestimiento de pasta blanca es indicado para su uso en paredes por sus propiedades de ligereza y facilidad de trabajo: se consigue una mejor facilidad y rapidez de cortes y perforación, reduciendo los tiempos y costes de colocación. / Если керамогранит, в силу своей твердости и стойкости, особенно рекомендован для полов, то такие характеристики, как небольшой вес и высокая обрабатываемость, делают плитку из белой глины идеальной для монтажа на стену: легкость и быстрота резки и сверления снижают затраты времени и денег на укладку.

While porcelain tiles are ideal for use on the floor thanks to their hardness and extreme durability, the light weight and workability of white body tiles make them ideal for use on walls: cuts and holes can be made quickly and easily, reducing installation time and costs. / Mentre il gres porcellanato è ideale per l'uso a pavimento, per la sua durezza e l'estrema resistenza, le caratteristiche di leggerezza e lavorabilità del rivestimento in pasta bianca lo rendono ideale per l'uso a parete: i tagli e i fori saranno eseguiti facilmente e velocemente, riducendo i tempi e i costi di posa. / Tandis que le grès cérame est idéal pour l'usage au sol en raison de sa dureté et de son extrême résistance, les caractéristiques de légèreté et d'usinabilité des carreaux en pâte blanche en font l'idéal pour l'usage mural : les découpes et les perçages s'effectuent facilement et rapidement, en réduisant les temps et les coûts de la pose. / Während das Feinsteinzeug dank seiner Härte und extremen Widerstandsfähigkeit ideal für die Fußbodenverlegung ist, machen die Leichtigkeit und die Verarbeitungsfreundlichkeit der weißscherbigen Wandbeläge diese ideal für Wandverlegungen: Schnitte und Bohrungen werden leicht und schnell ausgeführt, wodurch die Verlegungszeiten und -kosten sich verringern. / Si bien el gres porcelánico es indicado para su uso en pavimentos, por su dureza y máxima resistencia, el revestimiento de pasta blanca es indicado para su uso en paredes por sus propiedades de ligereza y facilidad de trabajo: se consigue una mejor facilidad y rapidez de cortes y perforación, reduciendo los tiempos y costes de colocación. / Если керамогранит, в силу своей твердости и стойкости, особенно рекомендован для полов, то такие характеристики, как небольшой вес и высокая обрабатываемость, делают плитку из белой глины идеальной для монтажа на стену: легкость и быстрота резки и сверления снижают затраты времени и денег на укладку.

Ease of installation / Facilità di lavorazione / Facilité de travail / Verarbeitungsfreundlichkeit / Fácil de trabajar / Легкость обработки

Cuts, holes, and bevels are easily made and reduce the time it takes to lay the white body tiles. / Tagli, fori, bisellature sono facili da realizzare e rendono più veloce la posa dei rivestimenti in pasta bianca. / Les découpes, les perçages et les biseautés sont faciles à réaliser et rendent plus rapide la pose des carrelages en pâte blanche. / Schnitte, Bohrungen, Abkantungen sind leicht zu verwirklichen, daher können weißscherbige Keramikbeläge überall schneller verlegt werden. / Cortes, perforaciones y biselados se realizan fácilmente y la instalación de los revestimientos de pasta blanca se hace con rapidez. / Легкость резки, сверления, сквашивания граней ускоряет процесс укладки настенной плитки из белой глины.

Extremely easy to clean / Estrema facilità di pulizia / Nettoyage extrêmement facile / Extrem einfache Reinigung / Máxima facilidad de limpieza / Предельная простота ухода

White body ceramic tiles can be cleaned with a simple passage of hot water or neutral detergent. / I rivestimenti ceramici in pasta bianca si puliscono con un semplice passaggio di acqua calda o detergente neutro. / Les carrelages céramiques en pâte blanche se nettoient simplement avec de l'eau chaude ou avec un détergent neutre. / Die weißscherbigen Keramikbeläge werden einfach durch Abwischen mit warmem Wasser oder einem neutralen Putzmittel gereinigt. / Los revestimientos cerámicos de pasta blanca se limpian pasando un trapo húmedo con agua caliente o detergente neutro. / Настенная плитка из белой глины очищается теплой водой или нейтральным моющим средством.

Green Project

Sustainability / Sostenibilità

In the environmental and economic sciences, sustainability is defined as the condition of development capable of ensuring the satisfaction of the needs of the present generation without compromising the ability of future generations to realize their own. Several international certifications guarantee that the Atlas Concorde products meet the criteria of sustainable construction, attesting to their low impact on the ecosystem, compliance with declared standards and attention to comfort.

Nelle scienze ambientali ed economiche, la sostenibilità è definita come condizione di uno sviluppo in grado di assicurare il soddisfacimento dei bisogni della generazione presente senza compromettere la possibilità delle generazioni future di realizzare i propri. Diverse certificazioni internazionali garantiscono che i prodotti Atlas Concorde rispondono ai criteri del costruire sostenibile, attestandone il basso impatto sull'ecosistema, la conformità agli standard dichiarati e l'attenzione al comfort abitativo.

Certifications / Certificazioni



ISO 9001

In 1995 Atlas Concorde obtained ISO 9001 quality certification for its products. It is an international recognition referring to the company's entire quality system, from the receipt of raw materials to their transformation, from the distribution of the product to their placement on the market.

Sin dal 1995 Atlas Concorde ha ottenuto per i propri prodotti la certificazione di qualità ISO 9001. Si tratta di un riconoscimento internazionale riferito all'intero sistema di qualità aziendale, dall'ingresso delle materie prime alla loro trasformazione, dalla distribuzione del prodotto alla sua immissione sul mercato.



LEED V4

All Atlas Concorde porcelain floor and white body wall tiles can be used in projects that follow the guidelines of the GREEN BUILDING COUNCIL, which promotes the independent certification system LEED BD&C v4 (Leadership in Energy and Environmental Design, Building Design & Construction), whose parameters establish precise criteria for the design and construction of buildings that are healthy, energy efficient and with low environmental impact.

All our products in porcelain stoneware and in white clay can therefore contribute to obtaining the LEED V4 rating of buildings, in relation to different areas: Sustainable Sites, Materials and Resources, Internal Environmental Quality.

Tutti i prodotti in gres porcellanato e in pasta bianca Atlas Concorde possono essere utilizzati in progetti che seguono le linee guida del GREEN BUILDING COUNCIL, che promuove il sistema di certificazione indipendente LEED BD&C v4 (Leadership in Energy and Environmental Design, Building Design & Construction), i cui parametri stabiliscono precisi criteri di progettazione e realizzazione di edifici salubri, energeticamente efficienti e a impatto ambientale contenuto. Tutti i nostri prodotti in gres porcellanato e in pasta bianca possono quindi contribuire all'ottenimento del rating LEED V4 degli edifici, relativamente a diverse aree tematiche: Siti Sostenibili, Materiali e Risorse, Qualità ambientale Interna.



EPD

Atlas Concorde also has an EPD declaration, which attests to the environmental sustainability of its products. The EPD (Environmental Product Declaration) also assesses the life cycle of a product, from extraction to production, transport, installation, maintenance, and cleaning. Atlas Concorde's EPD declaration was certified by the independent certifying body EPD ITALY.

Atlas Concorde dispone inoltre di una dichiarazione EPD, che attesta la sostenibilità ambientale dei prodotti. Anche la EPD (Environmental Product Declaration) valuta il ciclo di vita di un prodotto, dall'estrazione all'utilizzo passando per la produzione, il trasporto, l'installazione, la manutenzione e la pulizia. La dichiarazione EPD di Atlas Concorde è stata certificata dall'ente di certificazione indipendente EPD ITALY.



PEF

The environmental footprint of products (PEF, Product Environmental Footprint, according to Recommendation 2013/179/EU) is a measurement that, based on various criteria, indicates the environmental performance of a product or service over its lifetime, taking into account supply chain activities: from the extraction of raw materials, to the production, use, and end of life of the product. Atlas Concorde has a verified PEF. Atlas Concorde has a verified PEF.

Atlas Concorde's PEF was verified by the DNV-GL certifying body.

L'impronta ambientale dei prodotti (PEF, Product Environmental Footprint, secondo la Raccomandazione 2013/179/UE) è una misura che, sulla base di vari criteri, indica le prestazioni ambientali di un prodotto o servizio nel corso del proprio ciclo di vita, tenendo conto delle attività della catena di approvvigionamento: dall'estrazione di materie prime, alla produzione, all'uso e fine vita del prodotto. Atlas Concorde dispone di una PEF verificata. La PEF di Atlas Concorde è verificata dall'organismo di certificazione DNV-GL.



FDES

Atlas Concorde has also drafted an FDES environmental declaration (Fiche de déclaration environnementale et sanitaire), this also having the purpose of transparently disclosing the product's impact, covering each phase from product extraction to production and finally laying and use.

Atlas Concorde ha realizzato inoltre la dichiarazione ambientale FDES (Fiche de déclaration environnementale et sanitaire), anch'essa con lo scopo di rendicontare in modo trasparente l'impatto del prodotto, a partire dalla fase di estrazione del prodotto, passando dalla fase di produzione, fino alla posa ed all'utilizzo.



HPD

Atlas Concorde has a HPD (Health Product Declaration) declaration, a complete report on the health characteristics of the finished product, compiled according to the HPD standard.

Atlas Concorde dispone della dichiarazione HPD (Health Product Declaration), un report completo sulle caratteristiche di salubrità del prodotto finito, compilato secondo lo standard HPD.



CAM/ISO 14021

An environmental declaration according to the ISO 14021 international standard, observance of Minimum Environmental Criteria, and the adoption of sustainability policies demonstrate Atlas Concorde's attention to environmental issues and allow the inclusion of its products in Green Public Tenders.

La dichiarazione ambientale secondo lo standard internazionale ISO 14021 ed il rispetto dei requisiti dei Criteri Ambientali Minimi permette ad Atlas Concorde, grazie all'adozione di politiche di sostenibilità, di dimostrare l'attenzione alle problematiche ambientali e proporre l'inserimento dei propri prodotti negli Appalti Pubblici Verdi.

For further details, please refer to / Per ulteriori dettagli, fare riferimento a: atlasconcorde.com

V-SHADE, colour-shading / Stonalizzazione V-SHADE

The V-Shade classification indicates the colour shading level of a product, that is to say the chromatic and/or surface variation among tiles of the same collection. A strong colour shading is typical of ceramic collections that reproduce natural stones and marble. A moderate colour shading is typical of ceramic collections for which a homogeneous chromatic surface is an aesthetic feature of contemporary design.

La classificazione VShade indique le niveau de gradation du produit, c'est-à-dire de variation chromatique et/ou superficielle entre des dalles d'une même collection. Une forte variation est conseillée lorsque l'on utilise une collection qui rappelle des matériaux naturels comme la pierre et le marbre. Des variations de tons plus modérées caractérisent des collections où l'homogénéité chromatique superficielle est une qualité esthétique ou véritable indice de design contemporain.

La clasificación V-Shade indica el nivel de variación de tono del producto, o de variación cromática y/o superficial que existe entre las baldosas de una misma colección. Una variación de tono significativa es indicada en las colecciones que evocan materiales naturales como la piedra y el mármol. Variaciones de tono más moderadas caracterizan colecciones en que la homogeneidad cromática superficial es un valor estético índice de un diseño contemporáneo.



V1

Uniform appearance
Aspetto uniforme
Aspect uniforme
Gleichmäßiges Erscheinungsbild
Aspecto uniforme
Однородный вид



V2

Slight variation
Variazione moderata
Variation minimale
Leichte Abweichung
Variación mínima
Минимальная Неоднородность



V3

Moderate variation
Variazione sostanziale
Variation Modérée
Mäßige Abweichung
Variación moderada
Умеренная Неоднородность



V4

Substantial variation
Variazione sostanziale
Variation substantielle
Grundlegende Abweichung
Variación sustancial
Значительная Неоднородность

Serie / Series Série / Serie Serie / Серия	Colore / Colour Couleur / Farbe Color / Цвет	Stonalizzazione / Colour-shading Denuancement / Marmorierung Contraste / Цветовое отличие
AIX	Porcelain & Wall tiles	V3 Porcelain tiles
ARBOR	Porcelain tiles	V3
ARKSHADE	Porcelain & Wall tiles	V1
ARTY	Wall tiles	V1
AXI	Porcelain tiles	White Pine V2 Silver Fir V2 Grey Timber V2 Dark Oak V2 Golden Oak V3 Brown Chestnut V3
BLAZE	Porcelain & Wall tiles	V3
BOOST	Porcelain & Wall tiles	V3 Porcelain tiles
BOOST PRO	Porcelain & Wall tiles	V3 Porcelain tiles
BRAVE	Porcelain & Wall tiles	V2
BRICK	Wall tiles	Calacatta Extra V3 Statuario Select V3 Carrara V2 Silver Dream V2 Persian Jade V3 Royal Gold V3 White Bevel V1
DOLMEN PRO	Porcelain tiles	Cenere V2 Grigio V2 Rosso V2 Mix V4
DWELL	Porcelain & Wall tiles	V2
ETIC	Porcelain tiles	Ebano V2 Noce V3 Palissandro V3 Rovere V3 Rovere Bianco V2 Rovere Grigio V3 Ulivo V3
ETIC PRO	Porcelain tiles	V3
EWALL	Wall tiles	V2
EXENCE	Porcelain tiles	V2
GREENCOLORS	Porcelain tiles	V1
HEARTWOOD	Porcelain tiles	V3
KLIF	Porcelain & Wall tiles	V3 Porcelain tiles
KONE	Porcelain tiles	V2
MARK	Porcelain tiles	V3
LIMS	Porcelain & Wall tiles	V3 Porcelain tiles

Serie / Series Série / Serie Serie / Серия	Colore / Colour Couleur / Farbe Color / Цвет	Stonalizzazione / Colour-shading Denuancement / Marmorierung Contraste / Цветовое отличие
MARVEL	Porcelain & Wall tiles	V2
MARVEL DREAM	Porcelain & Wall tiles	Brazil Green V3 Ultramarine V3 Crystal Beauty V2 Bianco Fantastico V2 Morning Sky V3 Grigio Intenso V2 Black Atlantis V2
MARVEL EDGE	Porcelain & Wall tiles	Royal Calacatta V3 Imperial White V2 Elegant Sable V2 Gris Supreme V2 Absolute Brown V3 Gold Onyx V3 Agata Azul V3 Red Luxury V3
MARVEL GEMS	Porcelain tiles	V2
MARVEL PRO	Porcelain & Wall tiles	Statuario Select V3 Grey Fleury V3 Noir St. Laurent V2 Crema Delicato V2 Travertino Alabastrino V2 Travertino Silver V2 Calacatta Delicato V2 Calacatta Prestigio V2 Statuario Supremo V2 Calacatta Imperiale V3
MARVEL SHINE	Porcelain & Wall tiles	V2
MARVEL STONE	Porcelain & Wall tiles	V2
MEK	Porcelain & Wall tiles	V2
NASH	Porcelain tiles	V3
NID	Porcelain tiles	V2
NORDE	Porcelain tiles	V3
PRISM	Porcelain & Wall tiles	V2
RAW	Porcelain & Wall tiles	V3
SEASTONE	Porcelain tiles	V2
TRUST	Porcelain tiles	V3
VENTI BOOST	Porcelain tiles	Classic Carpet 1, 2, 3 V2 Blue Carpet 1, 2, 3 V2 Carpet 1, 2, 3 Warm V2 Carpet 1, 2, 3 Cold V2 Classic Mix, Blue Mix V4 Mix Warm, Mix Cold V4

<https://www.atlasconcorde.com/en/ceramic-glossary/v/>

Denuancement, V-SHADE / V-SHADE, Marmorierung / Contraste, V-SHADE / Цветовое отличие, V-SHADE



atlas concorde

Porcelain Tiles

Complies with	EN 14411 (ISO 13006)	Appendix	G	Group	Bla
Conforme alla norma	EN 14411 (ISO 13006)	Appendice	G	Gruppo	Bla
Conforme à la norme	EN 14411 (ISO 13006)	Appendice	G	Groupe	Bla
Entsprechend	EN 14411 (ISO 13006)	Anhang	G	Gruppe	Bla
Conforme a la norma	EN 14411 (ISO 13006)	Apéndice	G	Grupo	Bla
Соответствует норме	EN 14411 (ISO 13006)	Приложение	G	Группа	Bla

- ^(*) The permissible deviation, in % or mm, of the average size for each tile (2 or 4 sides) from work size (WS).
Deviazione ammissibile, in % oppure mm, della dimensione media di ogni piastrella (2 oppure 4 lati) dalla dimensione di fabbricazione (WS).
- ^(**) The permissible deviation, in % or mm, of the average thickness for each tile from the work size thickness (WS).
Deviazione ammissibile, in % oppure mm, dello spessore medio di ogni piastrella dallo spessore riportato nella dimensione di fabbricazione (WS).
- ^(***) The maximum permissible deviation from straightness, in % or mm, related to the corresponding work sizes (WS).
Deviazione massima ammissibile di rettilineità, in % oppure mm, in rapporto alle dimensioni di fabbricazione (WS) corrispondenti.
- ^(****) The maximum permissible deviation from rectangularity, in % or mm, related to the corresponding work sizes (WS).
Deviazione massima ammissibile di ortogonalità, in % oppure mm, in rapporto alle dimensioni di fabbricazione (WS) corrispondenti.
- c.c.** The maximum permissible deviation from centre curvature, in % or mm, related to diagonal calculated from the work sizes (WS).
Deviazione massima ammissibile della curvatura del centro, in % oppure mm, in rapporto alla diagonale calcolata secondo le dimensioni di fabbricazione (WS).
- e.c.** The maximum permissible deviation from edge curvature, in % or mm, related to the corresponding work sizes (WS).
Deviazione massima ammissibile della curvatura dello spigolo, in % oppure mm, in rapporto alle dimensioni di fabbricazione (WS) corrispondenti.
- w.** The maximum permissible deviation from warpage, in % or mm, related to diagonal calculated from the work sizes (WS).
Deviazione massima ammissibile dallo svergolamento, in % oppure mm, in rapporto alla diagonale calcolata secondo le dimensioni di fabbricazione (WS).
- (1)** Determination of slip resistance of pedestrian surfaces; it does not cover sports surfaces and road surfaces for vehicles (skid resistance).
Determinazione della resistenza allo scivolamento delle superfici pedonabili; non si applica alle pavimentazioni sportive ed alle pavimentazioni stradali veicolari.
- (2).** Anti-slip performance is guaranteed at the time of delivery of the product.
Le prestazioni anti-slip vengono garantite al momento della consegna del prodotto.
- (3).** However, tiles with a DCOF of 0.42 or greater are not necessarily suitable for all projects. The specifier shall determine tiles appropriate for specific project conditions, considering by way of example, but not in limitation, type of use, traffic, expected contaminants, expected maintenance, expected wear, and manufacturers' guidelines and recommendations.
Tuttavia, piastrelle con un DCOF di 0.42 o superiore non sono necessariamente adatte per tutti i progetti. Il specificatore deve determinare le piastrelle appropriate per specifiche condizioni di progetto, considerando per esempio, ma non in limitazione, tipo di uso, traffico, contaminanti attesi, manutenzione attesa, usura attesa, linee guida e raccomandazioni dei produttori.
- (4).** For further details, please refer to outdoor design general catalogue. Per maggiori informazioni riferirsi al catalogo generale Outdoor Design.
- (5).** Only for products with 20 mm thickness. Solo per prodotti a 20mm di spessore.

Technical specification symbols / Simbologia caratteristiche tecniche

			Length and width Lunghezza e larghezza / Longuer et largeur / Länge und breite / Longitud y anchura / Размеры сторон (*) Thickness Spessore / Epaisseur / Stärke / Grosor / Толщина (**) Straightness of sides Rettilineità degli spigoli / Rectitude des aretes / Kantengeradheit / Rectilinearidad de las aristas / Кривизна сторон (***)
Regularity characteristics Caratteristiche di regolarità Caractéristiques de régularité Regelmäßigkeit Características de regularidad Свойства правильности	ISO 10545-2		Rectangularity Ortogonalità / Orthogonalite / Rechtwinkligkeit / Ortogonalidad / Косоугольность (****) (Measurement only on short edges when L/l ≥ 3) (Misurazione da condurre solo sui lati corti quando L/l ≥ 3) (Ne mesurez que les côtés courts lorsque L/l ≥ 3) (Messung nur an den kurzen Seiten, wenn L/l ≥ 3) (Medir solo en los lados cortos cuando L/l ≥ 3) (Измерение проводится только на короткой грани, когда L/l ≥ 3)
			Surface flatness Planarità / Planimetrie / Ebenflächigkeit / Planaridad / Кривизна лицевой поверхности c.c. e.c. ws.
Structural characteristics Caratteristiche strutturali Caractéristiques structurales Strukturelle Eigenschaften Características estructurales Конструктивные свойства	ISO 10545-3 ASTM C373-18		Water absorption (in % by mass) Massa d'acqua assorbita (come % della massa) / Masse d'eau absorbée (en % de la masse) / Aufgenommene Wassermasse (in % der Masse) / Peso de agua absorbida (como % de la masa) / Водопоглощение (% от массы)
Bulk mechanical characteristics Caratt. meccaniche massive Caractéristiques mécaniques massives Mechanische Eigenschaften des Scherben Características mecánicas Механические свойства массы	ISO 10545-4 EN 1339 Annex F ISO 10545-5		Breaking strength Sforzo di rottura / Force de rupture / Bruchlast / Esfuerzo de ruptura / Усилие на излом Modulus of rupture Resistenza alla flessione / Résistance à la flexion / Biegefestigkeit / Resistencia a la flexión / Устойчивость к изгибу Bending strength and breaking load Resistenza a flessione e al carico di rottura / Résistance à la flexion et à la charge de rupture / Biege- und Bruchfestigkeit / Extraordinaria resistencia a la flexión y a la carga de rotura / Предел прочности при изгибе и разрушающая нагрузка (4)(5)
			Impact resistance, as coefficient of restitution Resistenza all'impatto, espresso come coefficiente di restituzione / Résistance au choc, par mesurage du coefficient de restitution / Schlagzähigkeit, ausgedrückt als Restitutionskoeffizient / Resistencia al impacto, expresada como coeficiente de restitución / Ударопрочность, выраженная коэффициентом восстановления
Surface mechanical characteristics Caratt. meccaniche superficiali Caractéristiques mécaniques superficielles Mechanische Eigenschaften der Oberfläche Características mecánicas superficiales Поверхностные механические свойства	EN 101 ⁽¹⁾ ISO 10545-6		MOHS hardness Durezza MOHS / Dureté Mohs / Ritzhärte nach Mohs / Dureza Mohs / Твёрдость по Моосу
			Resistance to deep abrasion of unglazed tiles (removed volume) Resistenza all'abrasione profonda delle piastrelle non smaltate (volume materiale asportato) / Résistance à l'abrasion profonde des carreaux non émaillés (volume du matériau retiré) / Widerstand gegen Tiefenverschleiß von unglasierten Fliesen (Materialabtrag bzw. Volumenverlust) / Resistencia a la abrasión profunda de las baldosas no esmaltadas (volumen material extraído) / Стойкость к глубокому истиранию неглазурованных плиток (объем удаленного материала)
Thermal and hygrometric characteristics Caratt. termo-igrometriche C. thermiques et hygrométriques Thermo-hygrometrische Eigenschaften Características termohigrométricas Тепловые и гигрометрические свойства	ISO 10545-8 ISO 10545-9 ISO 10545-10 ISO 10545-12		Coefficient of thermal linear EXPANSION Coefficiente di DILATAZIONE TERMICA lineare / Coefficient de dilatation thermique linéique / Lineare thermische Dehnung / Coeficiente de dilatación térmica lineal / Коэффициент линейного расширения
			THERMAL SHOCK resistance Resistenza agli SBALZI TERMICI / Résistance aux écarts de température / Temperaturwechs elbeständigkeit / Resistencia a los cambios de temperatura / Устойчивость к перепаду температур
			Moisture expansion (in mm/m) Dilatazione all'umidità (in mm/m) / Dilatation à l'humidité (en mm/m) / Feuchtigkeitsausdehnung (in mm/m) / Dilatación por la humedad (en mm/m) / Расширение под воздействием влаги (в мм/м)
			FROST resistance Resistenza al GELO / Résistance aux gel / Frostbeständigkeit / Resistencia a las heladas / Морозоустойчивость
Physical properties Proprietà fisiche Proprietés physiques Physikalische Eigenschaften Propiedades físicas Физические характеристики	EN 1348 -		Bond strength/adhesion for improved cementitious adhesives Adesione a trazione con adesivi cementizi migliorati / Adhérence par traction avec des ciments-colle améliorés / Scherfestigkeit mit verbesserten zementhaltigen Klebern / Adherencia a tracción con adhesivos cementosos mejorados / Прочность на растяжение при приклеивании улучшенными цементными клеями
			Reaction to fire Reazione al fuoco / Réaction au feu / Brandverhalten / Reacción al fuego / Огнестойкость
Chemical characteristics Caratteristiche chimiche Caractéristiques chimiques Chemische Eigenschaften Características químicas Химические свойства	ISO 10545-13 ISO 10545-14		Resistance to household chemicals and swimming pool salts Resistenza ai prodotti chimici di uso domestico ed agli additivi per piscina / Résistance aux produits chimiques à usage domestique et aux adjuvants pour piscine / Beständigkeit gegen Haushaltschemikalien und Badewasserzusätze / Resistencia a los productos químicos de uso doméstico / Стойкость к химикатам, используемым в быту и для бассейнов
			Resistance to low concentrations of ACIDS and ALKALIS Resistenza a basse concentrazioni di ACIDI e ALCALI / Résistance aux acides et aux alcalis à basse concentration / Beständigkeit gegen niedrigkonzentrierte Säuren und Laugen / Resistencia a los ácidos y bases de baja concentración / Сопротивление кислотам и щелочам низкой концентрации
			Resistance to high concentrations of ACIDS and ALKALIS Resistenza ad alte concentrazioni di ACIDI e ALCALI / Résistance aux acides et aux alcalis à haute concentration / Beständigkeit gegen hochkonzentrierte Säuren und Laugen / Resistencia a los ácidos y bases de alta concentración / Сопротивление кислотам и щелочам высокой концентрации
			Resistance to STAINING, for unglazed tiles Resistenza alle MACCHIE per piastrelle non smaltate / Résistance aux taches pour carreaux non émaillés / Widerstand gegen Fleckenbildung für unglasierte Fliesen / Resistencia a las manchas para azulejos no esmaltados / Устойчивость к загрязнению, для неглазурованных плиток
	DIN 51130		Shod Ramp Test Metodo della rampa "calzato" / Test de la rampe « chaussé » / Rampenmethode mit Schuhen / Método de la rampa "calzado" / Метод наклонной плоскости (в обуви)
	DIN 51097		Barefoot Ramp Test Metodo della rampa a piedi nudi / Test de la rampe à pieds nus / Rampenmethode barfuß / Método de la rampa a pies descalzos / Метод наклонной плоскости (босыми ногами) (1)(2)
Safety characteristics Caratteristiche di sicurezza Caractéristiques de sécurité Sicherheitsmerkmale Características de seguridad Характеристики безопасности	BS 7976 AS 4596 UNE-ENV 12633 B.C.R.A. Rep. CEC/81 ANSI A137.1		Pendulum Friction Test Metodo del Pendolo / Méthode du Pendule / Pendelmethode / Método del péndulo / Метод маятника (1)(2)
			Coefficient of friction (COF) Coefficiente di attrito / Coefficient de frottement / Reibungskoeffizient / Coeficiente de roce / Коэффициент трения (1)(2)
			Dynamic coefficient of friction (DCOF) Coefficiente di attrito dinamico / Coefficient de frottement dynamique / Dynamischer Reibungskoeffizient / Coeficiente de roce dinámico (1)(2)(3) Динамический коэффициент трения

Caractéristiques techniques / Technische Daten / Características técnicas / Технические характеристики

			Requirements for nominal size N Requisiti per dimensione nominale N			BOOST Outdoor ✚ 20mm	BOOST PRO					
			7 cm ≤ N < 15 cm (mm)	N ≥ 15 cm (%)	N ≥ 15 cm (mm)		Matte	Matte ✚ 6mm	Grip			
Regularity characteristics		Length and width Lunghezza e larghezza	± 0,9 (*) Non-rect. ± 0,4 (*) Rect.	± 0,6 (*) Non-rect. ± 0,3 (*) Rect.	± 2,0 (*) Non-rect. ± 1,0 (*) Rect.	Suitable for Conforme	Suitable for Conforme	Suitable for Conforme	Suitable for Conforme			
		Thickness Spessore	± 0,5 (**)	± 5 (**)	± 0,5 (**)	Suitable for Conforme	Suitable for Conforme	Suitable for Conforme	Suitable for Conforme			
		Straightness of sides Rettilineità degli spigoli	± 0,8 (***) Non-rect. ± 0,4 (***) Rect.	± 0,5 (***) Non-rect. ± 0,3 (***) Rect.	± 1,5 (***) Non-rect. ± 0,8 (***) Rect.	Suitable for Conforme	Suitable for Conforme	Suitable for Conforme	Suitable for Conforme			
		Rectangularity (Measurement only on short edges when L/l ≥ 3) Ortogonalità (Misurazione da condurre solo sui lati corti quando L/l ≥ 3)	± 0,8 (****) Non-rect. ± 0,4 (****) Rect.	± 0,5 (****) Non-rect. ± 0,3 (****) Rect.	± 2,0 (****) Non-rect. ± 1,5 (****) Rect.	Suitable for Conforme	Suitable for Conforme	Suitable for Conforme	Suitable for Conforme			
		Surface flatness Planarità	c.c. ± 0,8 Non-rect. c.c. ± 0,6 Rect. e.c. ± 0,8 Non-rect. e.c. ± 0,6 Rect. w. ± 0,8 Non-rect. w. ± 0,6 Rect.	c.c. ± 0,5 Non-rect. c.c. ± 0,4 Rect. e.c. ± 0,5 Non-rect. e.c. ± 0,4 Rect. w. ± 0,5 Non-rect. w. ± 0,4 Rect.	c.c. ± 2,0 Non-rect. c.c. ± 1,8 Rect. e.c. ± 2,0 Non-rect. e.c. ± 1,8 Rect. w. ± 2,0 Non-rect. w. ± 1,8 Rect.	Suitable for Conforme	Suitable for Conforme	Suitable for Conforme	Suitable for Conforme			
Structural characteristics		Water absorption (in % by mass) Massa d'acqua assorbita (come % della massa)	E _v ≤ 0,5% Individual max 0,6% E _v ≤ 0,5% Valore max singolo 0,6%			≤ 0,1 %	≤ 0,1 %	≤ 0,1 %	≤ 0,1 %			
			Requirement ANSI A137.1 Water Absorption Max ≤ 0,5%			≤ 0,5 %	≤ 0,5 %	≤ 0,5 %	≤ 0,5 %			
Bulk mechanical characteristics		Breaking strength Storzo di rottura	S ≥ 700N (for thickness < 7,5 mm - per spessore < 7,5 mm) S ≥ 1300N (for thickness ≥ 7,5 mm - per spessore ≥ 7,5 mm)			S ≥ 10000 N	S ≥ 1500 N	S ≥ 1000 N	S ≥ 1500 N			
		Modulus of rupture Resistenza alla flessione	R ≥ 35 N/mm ²			R ≥ 45 N/mm ²	R ≥ 40 N/mm ²	R ≥ 40 N/mm ²	R ≥ 40 N/mm ²			
		Bending strength and breaking load Resistenza a flessione e al carico di rottura (4)/(5)	EN 1339 Annex F			≥ T11 120x120 60x60	≥ U11 90x90	≥ U4 60x120	-			
		Impact resistance, as coefficient of restitution Resistenza all'impatto, espresso come coefficiente di restituzione	ISO 10545-5			Declared value Valore dichiarato			≥ 0,55	≥ 0,55	≥ 0,55	≥ 0,55
Surface mechanical characteristics		Mohs hardness Durezza Mohs	EN 101			8	6	6	8			
		Resistance to deep abrasion of unglazed tiles (removed volume) Resistenza all'abrasione profonda delle piastrelle non smaltate (volume materiale asportato)	ISO 10545-6			≤ 175 mm ³	≤ 150 mm ³	≤ 150 mm ³	≤ 150 mm ³	≤ 150 mm ³		
Thermal and hygrometric characteristics		Coefficient of thermal linear expansion Coefficiente di dilatazione termica lineare	ISO 10545-8			Declared value Valore dichiarato			≤ 7 MK ⁻¹	≤ 7 MK ⁻¹	≤ 7 MK ⁻¹	≤ 7 MK ⁻¹
		Thermal shock resistance Resistenza agli sbalzi termici	ISO 10545-9			Pass according to EN ISO 10545-1 Test superato in accordo con ISO 10545-1			Resistant Resiste	Resistant Resiste	Resistant Resiste	Resistant Resiste
		Moisture expansion (in mm/m) Dilatazione all'umidità (in mm/m)	ISO 10545-10			Declared value Valore dichiarato			≤ 0,01% (0,1mm/m)	≤ 0,01% (0,1mm/m)	≤ 0,01% (0,1mm/m)	≤ 0,01% (0,1mm/m)
		Frost resistance Resistenza al gelo	ISO 10545-12			Pass according to EN ISO 10545-1 Test superato in accordo con ISO 10545-1			Resistant Resiste	Resistant Resiste	Resistant Resiste	Resistant Resiste
Physical properties		Bond strength/adhesion for improved cementitious adhesives Adesione a trazione con adesivi cementizi migliorati	EN 1348			Declared value Valore dichiarato			≥ 1,0 N/mm ² (Class C2 - EN 12004)	≥ 1,0 N/mm ² (Class C2 - EN 12004)	≥ 1,0 N/mm ² (Class C2 - EN 12004)	≥ 1,0 N/mm ² (Class C2 - EN 12004)
		Reaction to fire Reazione al fuoco	-			Class A1 or A1 _s Classe A1 oppure A1 _s			A1 - A1 _s	A1 - A1 _s	A1 - A1 _s	A1 - A1 _s
Chemical characteristics		Resistance to household chemicals and swimming pool salts Resistenza ai prodotti chimici di uso domestico ed agli additivi per piscina	ISO 10545-13			Minimum Class B Classe minima B			A	A	A	A
		Resistance to low concentrations of acids and alkalis Resistenza a basse concentrazioni di acidi e alcali				Declared Class Classe dichiarata			LA	LA	LA	LA
		Resistance to high concentrations of acids and alkalis Resistenza ad alte concentrazioni di acidi e alcali				Declared Class Classe dichiarata			HA	HA	HA	HA
Safety characteristics (1)/(2)		Resistance to staining, for unglazed tiles Resistenza alle macchie per piastrelle non smaltate	ISO 10545-14			Declared Class Classe dichiarata			5	5	5	5
		Shod Ramp Test Metodo della rampa "calzata"	DIN 51130			Declared value Valore dichiarato			R11	R10	R9	R11
		Barefoot Ramp Test Metodo della rampa a piedi nudi	DIN 51097			Declared value Valore dichiarato			A+B+C	A+B	A	A+B+C
		Pendulum Friction Test Metodo del Pendolo	BS 7976			PTV ≥ 36 classifies the surface as "low slip risk"			≥ 36 Dry ≥ 36 Wet	≥ 36 Dry ≥ 36 Wet	(●)	≥ 36 Dry ≥ 36 Wet
			AS 4586			Declared Classification of the new pedestrian surface materials according to the Pendulum Test			Class P4	Class P3	(●●)	Class P4
			UNE-ENV 12633			Declared value Valore dichiarato			Class C3	Class C2	(●●●)	Class C3
Coefficient of friction (COF) Coefficiente di attrito	B.C.R.A. Rep. CEC/81			D. M. 236/89 del 14/06/89 μ > 0,40 per elemento scivolante cuoio su pavimentazione asciutta μ > 0,40 per elemento scivolante gomma dura su pavimentazione bagnata			> 0,40 Asciutto > 0,40 Bagnato	> 0,40 Asciutto > 0,40 Bagnato	> 0,40 Asciutto > 0,40 Bagnato	> 0,40 Asciutto > 0,40 Bagnato		
Dynamic coefficient of friction (DCOF) Coefficiente di attrito dinamico	ANSI A137.1			ANSI A.137.1-2017 Requires a minimum value of 0.42 for level interior space expected to be walked upon when wet. (3)			> 0,42 Wet	> 0,42 Wet	> 0,42 Wet	> 0,42 Wet		

BOOST PRO	BRAVE			DOLMEN PRO				DWELL			ETIC		ETIC PRO			
	Outdoor ✚ 20mm	Matte	Grip	Outdoor ✚ 20mm	Matte	Grip	Textured	Outdoor ✚ 20mm	Matte	Polished	Outdoor ✚ 20mm	Matte	Matte	Grip	Outdoor ✚ 20mm	
Suitable for Conforme	Suitable for Conforme	Suitable for Conforme	Suitable for Conforme	Suitable for Conforme	Suitable for Conforme	Suitable for Conforme	Suitable for Conforme	Suitable for Conforme	Suitable for Conforme	Suitable for Conforme	Suitable for Conforme	Suitable for Conforme	Suitable for Conforme	Suitable for Conforme	Suitable for Conforme	
Suitable for Conforme	Suitable for Conforme	Suitable for Conforme	Suitable for Conforme	Suitable for Conforme	Suitable for Conforme	Suitable for Conforme	Suitable for Conforme	Suitable for Conforme	Suitable for Conforme	Suitable for Conforme	Suitable for Conforme	Suitable for Conforme	Suitable for Conforme	Suitable for Conforme	Suitable for Conforme	
Suitable for Conforme	Suitable for Conforme	Suitable for Conforme	Suitable for Conforme	Suitable for Conforme	Suitable for Conforme	Suitable for Conforme	Suitable for Conforme	Suitable for Conforme	Suitable for Conforme	Suitable for Conforme	Suitable for Conforme	Suitable for Conforme	Suitable for Conforme	Suitable for Conforme	Suitable for Conforme	
Suitable for Conforme	Suitable for Conforme	Suitable for Conforme	Suitable for Conforme	Suitable for Conforme	Suitable for Conforme	Suitable for Conforme	Suitable for Conforme	Suitable for Conforme	Suitable for Conforme	Suitable for Conforme	Suitable for Conforme	Suitable for Conforme	Suitable for Conforme	Suitable for Conforme	Suitable for Conforme	
Suitable for Conforme	Not applicable to "strong" structures Non applicabile a strutturati forti			Not applicable to "strong" structures Non applicabile a strutturati forti				Suitable for Conforme	Suitable for Conforme	Suitable for Conforme	Suitable for Conforme	Suitable for Conforme	Suitable for Conforme	Suitable for Conforme	Suitable for Conforme	Not applicable to "strong" structures Non applicabile a strutturati forti
≤ 0,1 %	≤ 0,1 %	≤ 0,1 %	≤ 0,1 %	≤ 0,1 %	≤ 0,1 %	≤ 0,1 %	≤ 0,1 %	≤ 0,1 %	≤ 0,1 %	≤ 0,1 %	≤ 0,1 %	≤ 0,1 %	≤ 0,1 %	≤ 0,1 %	≤ 0,1 %	
≤ 0,5 %	≤ 0,5 %	≤ 0,5 %	≤ 0,5 %	≤ 0,5 %	≤ 0,5 %	≤ 0,5 %	≤ 0,5 %	≤ 0,5 %	≤ 0,5 %	≤ 0,5 %	≤ 0,5 %	≤ 0,5 %	≤ 0,5 %	≤ 0,5 %	≤ 0,5 %	
S ≥ 10000 N	S ≥ 1500 N	S ≥ 1500 N	S ≥ 10000 N	S ≥ 1500 N	S ≥ 1500 N	S ≥ 1500 N	S ≥ 10000 N	S ≥ 1500 N	S ≥ 1500 N	S ≥ 10000 N	S ≥ 2000 N	S ≥ 1500 N	S ≥ 1500 N	S ≥ 10000 N	S ≥ 10000 N	
R ≥ 45 N/mm ²	R ≥ 40 N/mm ²	R ≥ 40 N/mm ²	R ≥ 45 N/mm ²	R ≥ 40 N/mm ²	R ≥ 40 N/mm ²	R ≥ 40 N/mm ²	R ≥ 45 N/mm ²	R ≥ 40 N/mm ²	R ≥ 40 N/mm ²	R ≥ 45 N/mm ²	R ≥ 40 N/mm ²	R ≥ 40 N/mm ²	R ≥ 40 N/mm ²	R ≥ 40 N/mm ²	R ≥ 45 N/mm ²	
≥ T11	-	-	≥ T11 60x60	≥ U7 30x60	≥ U4 60x120 45x90	-	-	-	≥ T11 22,5x22,5	≥ U4 60x120 22,5x45,4	-	-	≥ U11 90x90	-	≥ U3 30x120	
≥ 0,55	≥ 0,55	≥ 0,55	≥ 0,55	≥ 0,55	≥ 0,55	≥ 0,55	≥ 0,55	≥ 0,55	≥ 0,55	≥ 0,55	≥ 0,55	≥ 0,55	≥ 0,55	≥ 0,55	≥ 0,55	
8	7	8	8	7	8	8	8	6	5	8	6	6	8	8		
≤ 150 mm ³	≤ 150 mm ³	≤ 150 mm ³	≤ 150 mm ³	≤ 150 mm ³	≤ 150 mm ³	≤ 150 mm ³	≤ 150 mm ³	≤ 150 mm ³	≤ 150 mm ³	≤ 150 mm ³	≤ 150 mm ³	≤ 150 mm ³	≤ 150 mm ³	≤ 150 mm ³	≤ 150 mm ³	
≤ 7 MK ⁻¹	≤ 7 MK ⁻¹	≤ 7 MK ⁻¹	≤ 7 MK ⁻¹	≤ 7 MK ⁻¹	≤ 7 MK ⁻¹	≤ 7 MK ⁻¹	≤ 7 MK ⁻¹	≤ 7 MK ⁻¹	≤ 7 MK ⁻¹	≤ 7 MK ⁻¹	≤ 7 MK ⁻¹	≤ 7 MK ⁻¹	≤ 7 MK ⁻¹	≤ 7 MK ⁻¹	≤ 7 MK ⁻¹	
Resistant Resiste	Resistant Resiste	Resistant Resiste	Resistant Resiste	Resistant Resiste	Resistant Resiste	Resistant Resiste	Resistant Resiste	Resistant Resiste	Resistant Resiste	Resistant Resiste	Resistant Resiste	Resistant Resiste	Resistant Resiste	Resistant Resiste	Resistant Resiste	
≤ 0,01% (0,1mm/m)	≤ 0,01% (0,1mm/m)	≤ 0,01% (0,1mm/m)	≤ 0,01% (0,1mm/m)	≤ 0,01% (0,1mm/m)	≤ 0,01% (0,1mm/m)	≤ 0,01% (0,1mm/m)	≤ 0,01% (0,1mm/m)	≤ 0,01% (0,1mm/m)	≤ 0,01% (0,1mm/m)	≤ 0,01% (0,1mm/m)	≤ 0,01% (0,1mm/m)	≤ 0,01% (0,1mm/m)	≤ 0,01% (0,1mm/m)	≤ 0,01% (0,1mm/m)	≤ 0,01% (0,1mm/m)	
Resistant Resiste	Resistant Resiste	Resistant Resiste	Resistant Resiste	Resistant Resiste	Resistant Resiste	Resistant Resiste	Resistant Resiste	Resistant Resiste	Resistant Resiste	Resistant Resiste	Resistant Resiste	Resistant Resiste	Resistant Resiste	Resistant Resiste	Resistant Resiste	
≥ 1,0 N/mm ² (Class C2 - EN 12004)	≥ 1,0 N/mm ² (Class C2 - EN 12004)	≥ 1,0 N/mm ² (Class C2 - EN 12004)	≥ 1,0 N/mm ² (Class C2 - EN 12004)	≥ 1,0 N/mm ² (Class C2 - EN 12004)	≥ 1,0 N/mm ² (Class C2 - EN 12004)	≥ 1,0 N/mm ² (Class C2 - EN 12004)	≥ 1,0 N/mm ² (Class C2 - EN 12004)	≥ 1,0 N/mm ² (Class C2 - EN 12004)	≥ 1,0 N/mm ² (Class C2 - EN 12004)	≥ 1,0 N/mm ² (Class C2 - EN 12004)	≥ 1,0 N/mm ² (Class C2 - EN 12004)	≥ 1,0 N/mm ² (Class C2 - EN 12004)	≥ 1,0 N/mm ² (Class C2 - EN 12004)	≥ 1,0 N/mm ² (Class C2 - EN 12004)	≥ 1,0 N/mm ² (Class C2 - EN 12004)	
A1 - A1 _s	A1 - A1 _s	A1 - A1 _s	A1 - A1 _s	A1 - A1 _s	A1 - A1 _s	A1 - A1 _s	A1 - A1 _s	A1 - A1 _s	A1 - A1 _s	A1 - A1 _s	A1 - A1 _s	A1 - A1 _s	A1 - A1 _s	A1 - A1 _s	A1 - A1 _s	
A	A	A	A	A	A	A	A	A	A	A	A	A	A	A	A	
LA	LA	LA	LA	LA	LA	LA	LA	LA	LA	LA	LA	LA	LA	LA	LA	
HA	HA	HA	HA	HA	HA	HA	HA	HA	-	HA	HA	HA	HA	HA	HA	
5	5	5	5	5	5	5	5	5	5	5	5	5	5	5	5	
R11	R10	R12	R11	R10	R11	R11	R11	R9	N.C.	R11	R9	R9	R11	R11		
A+B+C	A+B	A+B+C	A+B+C	A+B	A+B+C	A+B+C	A+B+C	A	0	A+B+C	A	A	A+B+C	A+B+C		
≥ 36 Dry ≥ 36 Wet	≥ 36 Dry ≥ 36 Wet	≥ 36 Dry ≥ 36 Wet	≥ 36 Dry ≥ 36 Wet	≥ 36 Dry ≥ 36 Wet	≥ 36 Dry ≥ 36 Wet	≥ 36 Dry ≥ 36 Wet	≥ 36 Dry ≥ 36 Wet	(●)	≥ 36 Dry ≥ 36 Wet	≥ 36 Dry ≥ 36 Wet	(●)	(●)	≥ 36 Dry ≥ 36 Wet	≥ 36 Dry ≥ 36 Wet		
Class P4	Class P3	Class P4	Class P4	Class P3	Class P4	Class P4	Class P4	(●●)	-	Class P4	(●●)	(●●)	Class P4	Class P4		
Class C3	Class C2	Class C3	Class C3	Class C2	Class C3	Class C3	Class C3	(●●●)	-	Class C3	(●●●)	(●●●)	Class C3	Class C3		
> 0,40 Asciutto > 0,40 Bagnato	> 0,40 Asciutto > 0,40 Bagnato	> 0,40 Asciutto > 0,40 Bagnato	> 0,40 Asciutto > 0,40 Bagnato	> 0,40 Asciutto > 0,40 Bagnato	> 0,40 Asciutto > 0,40 Bagnato	> 0,40 Asciutto > 0,40 Bagnato	> 0,40 Asciutto > 0,40 Bagnato	> 0,40 Asciutto > 0,40 Bagnato	> 0,40 Asciutto < 0,40 Bagnato	> 0,40 Asciutto > 0,40 Bagnato	> 0,40 Asciutto > 0,40 Bagnato	> 0,40 Asciutto > 0,40 Bagnato	> 0,40 Asciutto > 0,40 Bagnato	> 0,40 Asciutto > 0,40 Bagnato		
> 0,42 Wet	> 0,42 Wet	> 0,42 Wet	> 0,42 Wet	> 0,42 Wet	> 0,42 Wet	> 0,42 Wet	> 0,42 Wet	> 0,42 Wet	< 0,42 Wet	> 0,42 Wet	> 0,42 Wet	> 0,42 Wet	> 0,42 Wet	> 0,42 Wet		

		Requirements for nominal size N Requisiti per dimensione nominale N			EXENCE			GRANIGLIATI			
		7 cm ≤ N < 15 cm (mm)		N ≥ 15 cm (%)		(mm)		Matte 30x30	Textured 30x30		
		± 0,9 (*) Non-rect. ± 0,4 (*) Rect.	± 0,6 (*) Non-rect. ± 0,3 (*) Rect.	± 2,0 (*) Non-rect. ± 1,0 (*) Rect.	± 0,5 (**)	± 5 (**)	± 0,5 (**)				
Regularity characteristics		Length and width Lunghezza e larghezza	ISO 10545-2	± 0,9 (***) Non-rect. ± 0,4 (***) Rect.	± 0,5 (***) Non-rect. ± 0,3 (***) Rect.	± 1,5 (***) Non-rect. ± 0,8 (***) Rect.	Suitable for Conforme	Suitable for Conforme	Suitable for Conforme		
		Thickness Spessore		± 0,8 (***) Non-rect. ± 0,4 (***) Rect.	± 0,5 (***) Non-rect. ± 0,3 (***) Rect.	± 2,0 (***) Non-rect. ± 1,5 (***) Rect.	Suitable for Conforme	Suitable for Conforme	Suitable for Conforme		
		Straightness of sides Rettilineità degli spigoli		c.c. ± 0,8 Non-rect. c.c. ± 0,6 Rect.	c.c. ± 0,5 Non-rect. c.c. ± 0,4 Rect.	c.c. ± 2,0 Non-rect. c.c. ± 1,8 Rect.	Suitable for Conforme	Suitable for Conforme	Suitable for Conforme		
	Rectangularity (Measurement only on short edges when L/l ≥ 3) Ortogonalità (Misurazione da condurre solo sui lati corti quando L/l ≥ 3)		e.c. ± 0,8 Non-rect. e.c. ± 0,6 Rect.	e.c. ± 0,5 Non-rect. e.c. ± 0,4 Rect.	e.c. ± 2,0 Non-rect. e.c. ± 1,8 Rect.	Suitable for Conforme	Suitable for Conforme	Suitable for Conforme	Suitable for Conforme		
	Surface flatness Planarità		w. ± 0,8 Non-rect. w. ± 0,6 Rect.	w. ± 0,5 Non-rect. w. ± 0,4 Rect.	w. ± 2,0 Non-rect. w. ± 1,8 Rect.	Suitable for Conforme	Suitable for Conforme	Not applicable to "strong" structures Non applicabile a strutturati forti	Not applicable to "strong" structures Non applicabile a strutturati forti		
	Water absorption (in % by mass) Massa d'acqua assorbita (come % della massa)	ISO 10545-3 ASTM C373-18	E _s ≤ 0,5% Individual max 0,6% E _v ≤ 0,5% Valore max singolo 0,6%			≤ 0,1 %	≤ 0,1 %	≤ 0,1 %	≤ 0,1 %	≤ 0,1 %	
Bulk mechanical characteristics		Breaking strength Storzo di rottura	ISO 10545-4	S ≥ 700N (for thickness < 7,5 mm - per spessore < 7,5 mm) S ≥ 1300N (for thickness ≥ 7,5 mm - per spessore ≥ 7,5 mm)			S ≥ 1500 N	S ≥ 1500 N	S ≥ 10000 N	S ≥ 1500 N	S ≥ 1500 N
		Modulus of rupture Resistenza alla flessione		R ≥ 35 N/mm ²			R ≥ 40 N/mm ²	R ≥ 40 N/mm ²	R ≥ 45 N/mm ²	R ≥ 40 N/mm ²	R ≥ 40 N/mm ²
		Bending strength and breaking load Resistenza all'impatto, espresso come coefficiente di restituzione	EN 1339 Annex F	-			-	-	≥ U3 30x120	-	-
		Impact resistance, as coefficient of restitution Resistenza all'impatto, espresso come coefficiente di restituzione	ISO 10545-5	Declared value Valore dichiarato			≥ 0,55	≥ 0,55	≥ 0,55	≥ 0,55	≥ 0,55
Surface mechanical characteristics		Mohs hardness Durezza Mohs	EN 101	-			6	8	8	6	7
		Resistance to deep abrasion of unglazed tiles (removed volume) Resistenza all'abrasione profonda delle piastrelle non smaltate (volume materiale asportato)	ISO 10545-6	≤ 175 mm ³			≤ 150 mm ³	≤ 150 mm ³	≤ 150 mm ³	≤ 150 mm ³	≤ 150 mm ³
Thermal and hygrometric characteristics		Coefficient of thermal linear expansion Coefficiente di dilatazione termica lineare	ISO 10545-8	Declared value Valore dichiarato			≤ 7 MK ⁻¹	≤ 7 MK ⁻¹	≤ 7 MK ⁻¹	≤ 7 MK ⁻¹	≤ 7 MK ⁻¹
		Thermal shock resistance Resistenza agli sbalzi termici	ISO 10545-9	Pass according to EN ISO 10545-1 Test superato in accordo con ISO 10545-1			Resistant Resiste	Resistant Resiste	Resistant Resiste	Resistant Resiste	Resistant Resiste
		Moisture expansion (in mm/m) Dilatazione all'umidità (in mm/m)	ISO 10545-10	Declared value Valore dichiarato			≤ 0,01% (0,1mm/m)	≤ 0,01% (0,1mm/m)	≤ 0,01% (0,1mm/m)	≤ 0,01% (0,1mm/m)	≤ 0,01% (0,1mm/m)
		Frost resistance Resistenza al gelo	ISO 10545-12	Pass according to EN ISO 10545-1 Test superato in accordo con ISO 10545-1			Resistant Resiste	Resistant Resiste	Resistant Resiste	Resistant Resiste	Resistant Resiste
Physical properties		Bond strength/adhesion for improved cementitious adhesives Adesione a trazione con adesivi cementizi migliorati	EN 1348	Declared value Valore dichiarato			≥ 1,0 N/mm ² (Class C2 - EN 12004)	≥ 1,0 N/mm ² (Class C2 - EN 12004)	≥ 1,0 N/mm ² (Class C2 - EN 12004)	≥ 1,0 N/mm ² (Class C2 - EN 12004)	≥ 1,0 N/mm ² (Class C2 - EN 12004)
		Reaction to fire Reazione al fuoco	-	Class A1 or A1 _s Classe A1 oppure A1 _s			A1 - A1 _s	A1 - A1 _s	A1 - A1 _s	A1 - A1 _s	A1 - A1 _s
Chemical characteristics		Resistance to household chemicals and swimming pool salts Resistenza ai prodotti chimici di uso domestico ed agli additivi per piscina	ISO 10545-13	Minimum Class B Classe minima B			A	A	A	A	A
		Resistance to low concentrations of acids and alkalis Resistenza a basse concentrazioni di acidi e alcali		Declared Class Classe dichiarata			LA	LA	LA	LA	LA
		Resistance to high concentrations of acids and alkalis Resistenza ad alte concentrazioni di acidi e alcali		Declared Class Classe dichiarata			HA	HA	HA	HA	HA
Safety characteristics (1)(2)		Shod Ramp Test Metodo della rampa "calzato"	DIN 51130	Declared value Valore dichiarato			R10	R11	R11	R9	R10
		Barefoot Ramp Test Metodo della rampa a piedi nudi	DIN 51097	Declared value Valore dichiarato			A+B	A+B+C	A+B+C	A	A+B
		Pendulum Friction Test Metodo del Pendolo	BS 7976	PTV ≥ 36 classifies the surface as "low slip risk"			≥ 36 Dry ≥ 36 Wet	≥ 36 Dry ≥ 36 Wet	≥ 36 Dry ≥ 36 Wet	☉	≥ 36 Dry ≥ 36 Wet
			AS 4586	Declared Classification of the new pedestrian surface materials according to the Pendulum Test			Class P3	Class P4	Class P4	☉☉	Class P3
			UNE-ENV 12633	Declared value Valore dichiarato			Class C2	Class C3	Class C3	☉☉☉	Class C3
		Coefficient of friction (COF) Coefficiente di attrito	B.C.R.A. Rep. CEC/81	D. M. 236/89 del 14/06/89 μ > 0,40 per elemento scivolante cuoio su pavimentazione asciutta μ > 0,40 per elemento scivolante gomma dura su pavimentazione bagnata			> 0,40 Asciutto > 0,40 Bagnato	> 0,40 Asciutto > 0,40 Bagnato	> 0,40 Asciutto > 0,40 Bagnato	> 0,40 Asciutto > 0,40 Bagnato	> 0,40 Asciutto > 0,40 Bagnato
Dynamic coefficient of friction (DCOF) Coefficiente di attrito dinamico	ANSI A137.1	ANSI A.137.1-2017 Requires a minimum value of 0.42 for level interior space expected to be walked upon when wet. (3)			> 0,42 Wet	> 0,42 Wet	> 0,42 Wet	> 0,42 Wet	> 0,42 Wet		

GRANIGLIATI				GROUND TRACK				HEARTWOOD		KLIF			KONE		
Matte 20x20 7,6mm	Matte 20x20 12mm	Textured 20x20 7,6mm	Anti-slip type P di Diamante 20x20	Stop	Turn	Go	Cross	Matte 18,5x150mm	Matte 20x120mm	Matte	Grip	Outdoor 20mm	Matte	Grip	Outdoor 20mm
Suitable for Conforme	Suitable for Conforme	Suitable for Conforme	Suitable for Conforme	Suitable for Conforme	Suitable for Conforme	Suitable for Conforme	Suitable for Conforme	Suitable for Conforme	Suitable for Conforme	Suitable for Conforme	Suitable for Conforme	Suitable for Conforme	Suitable for Conforme	Suitable for Conforme	Suitable for Conforme
Suitable for Conforme	Suitable for Conforme	Suitable for Conforme	Suitable for Conforme	Suitable for Conforme	Suitable for Conforme	Suitable for Conforme	Suitable for Conforme	Suitable for Conforme	Suitable for Conforme	Suitable for Conforme	Suitable for Conforme	Suitable for Conforme	Suitable for Conforme	Suitable for Conforme	Suitable for Conforme
Suitable for Conforme	Suitable for Conforme	Suitable for Conforme	Suitable for Conforme	Suitable for Conforme	Suitable for Conforme	Suitable for Conforme	Suitable for Conforme	Suitable for Conforme	Suitable for Conforme	Suitable for Conforme	Suitable for Conforme	Suitable for Conforme	Suitable for Conforme	Suitable for Conforme	Suitable for Conforme
Suitable for Conforme	Suitable for Conforme	Suitable for Conforme	Suitable for Conforme	Suitable for Conforme	Suitable for Conforme	Suitable for Conforme	Suitable for Conforme	Suitable for Conforme	Suitable for Conforme	Suitable for Conforme	Suitable for Conforme	Suitable for Conforme	Suitable for Conforme	Suitable for Conforme	Suitable for Conforme
Suitable for Conforme	Suitable for Conforme	Suitable for Conforme	Suitable for Conforme	Suitable for Conforme	Suitable for Conforme	Suitable for Conforme	Suitable for Conforme	Suitable for Conforme	Suitable for Conforme	Suitable for Conforme	Suitable for Conforme	Suitable for Conforme	Suitable for Conforme	Suitable for Conforme	Suitable for Conforme
Suitable for Conforme	Suitable for Conforme	Suitable for Conforme	Suitable for Conforme	Suitable for Conforme	Suitable for Conforme	Suitable for Conforme	Suitable for Conforme	Suitable for Conforme	Suitable for Conforme	Suitable for Conforme	Suitable for Conforme	Suitable for Conforme	Suitable for Conforme	Suitable for Conforme	Suitable for Conforme
Suitable for Conforme	Suitable for Conforme	Suitable for Conforme	Suitable for Conforme	Suitable for Conforme	Suitable for Conforme	Suitable for Conforme	Suitable for Conforme	Suitable for Conforme	Suitable for Conforme	Suitable for Conforme	Suitable for Conforme	Suitable for Conforme	Suitable for Conforme	Suitable for Conforme	Suitable for Conforme
Suitable for Conforme	Suitable for Conforme	Suitable for Conforme	Suitable for Conforme	Suitable for Conforme	Suitable for Conforme	Suitable for Conforme	Suitable for Conforme	Suitable for Conforme	Suitable for Conforme	Suitable for Conforme	Suitable for Conforme	Suitable for Conforme	Suitable for Conforme	Suitable for Conforme	Suitable for Conforme
Suitable for Conforme	Suitable for Conforme	Suitable for Conforme	Suitable for Conforme	Suitable for Conforme	Suitable for Conforme	Suitable for Conforme	Suitable for Conforme	Suitable for Conforme	Suitable for Conforme	Suitable for Conforme	Suitable for Conforme	Suitable for Conforme	Suitable for Conforme	Suitable for Conforme	Suitable for Conforme
Suitable for Conforme	Suitable for Conforme	Suitable for Conforme	Suitable for Conforme	Suitable for Conforme	Suitable for Conforme	Suitable for Conforme	Suitable for Conforme	Suitable for Conforme	Suitable for Conforme	Suitable for Conforme	Suitable for Conforme	Suitable for Conforme	Suitable for Conforme	Suitable for Conforme	Suitable for Conforme
Suitable for Conforme	Suitable for Conforme	Suitable for Conforme	Suitable for Conforme	Suitable for Conforme	Suitable for Conforme	Suitable for Conforme	Suitable for Conforme	Suitable for Conforme	Suitable for Conforme	Suitable for Conforme	Suitable for Conforme	Suitable for Conforme	Suitable for Conforme	Suitable for Conforme	Suitable for Conforme
Suitable for Conforme	Suitable for Conforme	Suitable for Conforme	Suitable for Conforme	Suitable for Conforme	Suitable for Conforme	Suitable for Conforme	Suitable for Conforme	Suitable for Conforme	Suitable for Conforme	Suitable for Conforme	Suitable for Conforme	Suitable for Conforme	Suitable for Conforme	Suitable for Conforme	Suitable for Conforme
Suitable for Conforme	Suitable for Conforme	Suitable for Conforme	Suitable for Conforme	Suitable for Conforme	Suitable for Conforme	Suitable for Conforme	Suitable for Conforme	Suitable for Conforme	Suitable for Conforme	Suitable for Conforme	Suitable for Conforme	Suitable for Conforme	Suitable for Conforme	Suitable for Conforme	Suitable for Conforme
Suitable for Conforme	Suitable for Conforme	Suitable for Conforme	Suitable for Conforme	Suitable for Conforme	Suitable for Conforme	Suitable for Conforme	Suitable for Conforme	Suitable for Conforme	Suitable for Conforme	Suitable for Conforme	Suitable for Conforme	Suitable for Conforme	Suitable for Conforme	Suitable for Conforme	Suitable for Conforme
Suitable for Conforme	Suitable for Conforme	Suitable for Conforme	Suitable for Conforme	Suitable for Conforme	Suitable for Conforme	Suitable for Conforme	Suitable for Conforme	Suitable for Conforme	Suitable for Conforme	Suitable for Conforme	Suitable for Conforme	Suitable for Conforme	Suitable for Conforme	Suitable for Conforme	Suitable for Conforme
Suitable for Conforme	Suitable for Conforme	Suitable for Conforme	Suitable for Conforme	Suitable for Conforme	Suitable for Conforme	Suitable for Conforme	Suitable for Conforme	Suitable for Conforme	Suitable for Conforme	Suitable for Conforme	Suitable for Conforme	Suitable for Conforme	Suitable for Conforme	Suitable for Conforme	Suitable for Conforme
Suitable for Conforme	Suitable for Conforme	Suitable for Conforme	Suitable for Conforme	Suitable for Conforme	Suitable for Conforme	Suitable for Conforme	Suitable for Conforme	Suitable for Conforme	Suitable for Conforme	Suitable for Conforme	Suitable for Conforme	Suitable for Conforme	Suitable for Conforme	Suitable for Conforme	Suitable for Conforme
Suitable for Conforme	Suitable for Conforme	Suitable for Conforme	Suitable for Conforme	Suitable for Conforme	Suitable for Conforme	Suitable for Conforme	Suitable for Conforme	Suitable for Conforme	Suitable for Conforme	Suitable for Conforme	Suitable for Conforme	Suitable for Conforme	Suitable for Conforme	Suitable for Conforme	Suitable for Conforme
Suitable for Conforme	Suitable for Conforme	Suitable for Conforme	Suitable for Conforme	Suitable for Conforme	Suitable for Conforme	Suitable for Conforme	Suitable for Conforme	Suitable for Conforme	Suitable for Conforme	Suitable for Conforme	Suitable for Conforme	Suitable for Conforme	Suitable for Conforme	Suitable for Conforme	Suitable for Conforme
Suitable for Conforme	Suitable for Conforme	Suitable for Conforme	Suitable for Conforme	Suitable for Conforme	Suitable for Conforme	Suitable for Conforme	Suitable for Conforme	Suitable for Conforme	Suitable for Conforme	Suitable for Conforme	Suitable for Conforme	Suitable for Conforme	Suitable for Conforme	Suitable for Conforme	Suitable for Conforme
Suitable for Conforme	Suitable for Conforme	Suitable for Conforme	Suitable for Conforme	Suitable for Conforme	Suitable for Conforme	Suitable for Conforme	Suitable for Conforme	Suitable for Conforme	Suitable for Conforme	Suitable for Conforme	Suitable for Conforme	Suitable for Conforme	Suitable for Conforme	Suitable for Conforme	Suitable for Conforme
Suitable for Conforme	Suitable for Conforme	Suitable for Conforme	Suitable for Conforme	Suitable for Conforme	Suitable for Conforme	Suitable for Conforme	Suitable for Conforme	Suitable for Conforme	Suitable for Conforme	Suitable for Conforme	Suitable for Conforme	Suitable for Conforme	Suitable for Conforme	Suitable for Conforme	Suitable for Conforme
Suitable for Conforme	Suitable for Conforme	Suitable for Conforme	Suitable for Conforme	Suitable for Conforme	Suitable for Conforme	Suitable for Conforme	Suitable for Conforme	Suitable for Conforme	Suitable for Conforme	Suitable for Conforme	Suitable for Conforme	Suitable for Conforme	Suitable for Conforme	Suitable for Conforme	Suitable for Conforme
Suitable for Conforme	Suitable for Conforme	Suitable for Conforme	Suitable for Conforme	Suitable for Conforme	Suitable for Conforme	Suitable for Conforme	Suitable for Conforme	Suitable for Conforme	Suitable for Conforme	Suitable for Conforme	Suitable for Conforme	Suitable for Conforme	Suitable for Conforme	Suitable for Conforme	Suitable for Conforme
Suitable for Conforme	Suitable for Conforme	Suitable for Conforme	Suitable for Conforme	Suitable for Conforme	Suitable for Conforme	Suitable for Conforme	Suitable for Conforme	Suitable for Conforme	Suitable for Conforme	Suitable for Conforme	Suitable for Conforme	Suitable for Conforme	Suitable for Conforme	Suitable for Conforme	Suitable for Conforme
Suitable for Conforme	Suitable for Conforme	Suitable for Conforme	Suitable for Conforme	Suitable for Conforme	Suitable for Conforme	Suitable for Conforme	Suitable for Conforme	Suitable for Conforme	Suitable for Conforme	Suitable for Conforme	Suitable for Conforme	Suitable for Conforme	Suitable for Conforme	Suitable for Conforme	Suitable for Conforme
Suitable for Conforme	Suitable for Conforme	Suitable for Conforme	Suitable for Conforme	Suitable for Conforme	Suitable for Conforme	Suitable for Conforme	Suitable for Conforme	Suitable for Conforme	Suitable for Conforme	Suitable for Conforme	Suitable for Conforme	Suitable for Conforme	Suitable for Conforme	Suitable for Conforme	Suitable for Conforme
Suitable for Conforme	Suitable for Conforme	Suitable for Conforme	Suitable for Conforme	Suitable for Conforme	Suitable for Conforme	Suitable for Conforme	Suitable for Conforme	Suitable for Conforme	Suitable for Conforme	Suitable for Conforme	Suitable for Conforme	Suitable for Conforme	Suitable for Conforme	Suitable for Conforme	Suitable for Conforme
Suitable for Conforme	Suitable for Conforme	Suitable for Conforme	Suitable for Conforme	Suitable for Conforme	Suitable for Conforme	Suitable for Conforme	Suitable for Conforme	Suitable for Conforme	Suitable for Conforme	Suitable for Conforme	Suitable for Conforme	Suitable for Conforme	Suitable for Conforme	Suitable for Conforme	Suitable for Conforme
Suitable for Conforme	Suitable for Conforme	Suitable for Conforme	Suitable for Conforme	Suitable for Conforme	Suitable for Conforme	Suitable for Conforme	Suitable for Conforme	Suitable for Conforme	Suitable for Conforme	Suitable for Conforme	Suitable for Conforme	Suitable for Conforme	Suitable for Conforme	Suitable for Conforme	Suitable for Conforme
Suitable for Conforme	Suitable for Conforme	Suitable for Conforme	Suitable for Conforme	Suitable for Conforme	Suitable for Conforme	Suitable for Conforme	Suitable for Conforme	Suitable for Conforme	Suitable for Conforme	Suitable for Conforme	Suitable for Conforme	Suitable for Conforme	Suitable for Conforme	Suitable for Conforme	Suitable for Conforme
Suitable for Conforme	Suitable for Conforme	Suitable for Conforme	Suitable for Conforme	Suitable for Conforme	Suitable for Conforme	Suitable for Conforme	Suitable for Conforme	Suitable for Conforme	Suitable for Conforme	Suitable for Conforme	Suitable for Conforme	Suitable for Conforme	Suitable for Conforme	Suitable for Conforme	Suitable for Conforme
Suitable for Conforme	Suitable for Conforme	Suitable for Conforme	Suitable for Conforme	Suitable for Conforme	Suitable for Conforme	Suitable for Conforme	Suitable for Conforme	Suitable for Conforme	Suitable for Conforme	Suitable for Conforme	Suitable for Conforme	Suitable for Conforme	Suitable for Conforme	Suitable for Conforme	Suitable for Conforme
Suitable for Conforme	Suitable for Conforme	Suitable for Conforme	Suitable for Conforme	Suitable for Conforme	Suitable for Conforme	Suitable for Conforme	Suitable for Conforme	Suitable for Conforme	Suitable for Conforme	Suitable for Conforme	Suitable for Conforme	Suitable for Conforme	Suitable for Conforme	Suitable for Conforme	Suitable for Conforme
Suitable for Conforme	Suitable for Conforme	Suitable for Conforme	Suitable for Conforme	Suitable for Conforme	Suitable for Conforme	Suitable for Conforme	Suitable for Conforme	Suitable for Conforme	Suitable for Conforme	Suitable for Conforme	Suitable for Conforme	Suitable for Conforme	Suitable for Conforme	Suitable for Conforme	Suitable for Conforme
Suitable for Conforme	Suitable for Conforme	Suitable for Conforme	Suitable for Conforme	Suitable for Conforme	Suitable for Conforme	Suitable for Conforme	Suitable for Conforme	Suitable for Conforme	Suitable for Conforme	Suitable for Conforme	Suitable for Conforme	Suitable for Conforme	Suitable for Conforme	Suitable for Conforme	Suitable for Conforme
Suitable for Conforme	Suitable for Conforme	Suitable for Conforme	Suitable for Conforme	Suitable for Conforme	Suitable for Conforme	Suitable for Conforme	Suitable for Conforme	Suitable for Conforme	Suitable for Conforme	Suitable for Conforme	Suitable for Conforme	Suitable for Conforme	Suitable for Conforme	Suitable for Conforme	Suitable for Conforme
Suitable for Conforme	Suitable for Conforme	Suitable for													

			Requirements for nominal size N Requisiti per dimensione nominale N			LIMS					MARK	
			7 cm ≤ N < 15 cm (mm)		N ≥ 15 cm (%)		Matte	Matte ✦6mm	Grip	Outdoor ✦20mm	Matte	
			(mm)	(%)	(mm)	(mm)						
Regularity characteristics		Length and width Lunghezza e larghezza	± 0,9 (*) Non-rect. ± 0,4 (*) Rect.	± 0,6 (*) Non-rect. ± 0,3 (*) Rect.	± 2,0 (*) Non-rect. ± 1,0 (*) Rect.	Suitable for Conforme	Suitable for Conforme	Suitable for Conforme	Suitable for Conforme	Suitable for Conforme	Suitable for Conforme	
		Thickness Spessore	± 0,5 (**)	± 5 (**)	± 0,5 (**)	Suitable for Conforme	Suitable for Conforme	Suitable for Conforme	Suitable for Conforme	Suitable for Conforme	Suitable for Conforme	
		Straightness of sides Rettilineità degli spigoli	± 0,8 (***) Non-rect. ± 0,4 (***) Rect.	± 0,5 (***) Non-rect. ± 0,3 (***) Rect.	± 1,5 (***) Non-rect. ± 0,8 (***) Rect.	Suitable for Conforme	Suitable for Conforme	Suitable for Conforme	Suitable for Conforme	Suitable for Conforme	Suitable for Conforme	
		Rectangularity (Measurement only on short edges when L/l ≥ 3) Ortogonalità (Misurazione da condurre solo sui lati corti quando L/l ≥ 3)	± 0,8 (****) Non-rect. ± 0,4 (****) Rect.	± 0,5 (****) Non-rect. ± 0,3 (****) Rect.	± 2,0 (****) Non-rect. ± 1,5 (****) Rect.	Suitable for Conforme	Suitable for Conforme	Suitable for Conforme	Suitable for Conforme	Suitable for Conforme	Suitable for Conforme	Suitable for Conforme
		Surface flatness Pianarità	c.c. ± 0,8 Non-rect. c.c. ± 0,6 Rect. e.c. ± 0,8 Non-rect. e.c. ± 0,6 Rect. w. ± 0,8 Non-rect. w. ± 0,6 Rect.	c.c. ± 0,5 Non-rect. c.c. ± 0,4 Rect. e.c. ± 0,5 Non-rect. e.c. ± 0,4 Rect. w. ± 0,5 Non-rect. w. ± 0,4 Rect.	c.c. ± 2,0 Non-rect. c.c. ± 1,8 Rect. e.c. ± 2,0 Non-rect. e.c. ± 1,8 Rect. w. ± 2,0 Non-rect. w. ± 1,8 Rect.	Suitable for Conforme	Suitable for Conforme	Suitable for Conforme	Not applicable to "strong" structures Non applicabile a strutturati forti	Suitable for Conforme	Suitable for Conforme	Suitable for Conforme
Structural characteristics		Water absorption (in % by mass) Massa d'acqua assorbita (come % della massa)	E _v ≤ 0,5% Individual max 0,6% E _v ≤ 0,5% Valore max singolo 0,6%			≤ 0,1 %	≤ 0,1 %	≤ 0,1 %	≤ 0,1 %	≤ 0,1 %	≤ 0,1 %	
		Requirement ANSI A137.1 Water Absorption Max ≤ 0,5%	≤ 0,5 %	≤ 0,5 %	≤ 0,5 %	≤ 0,5 %	≤ 0,5 %	≤ 0,5 %	≤ 0,5 %	≤ 0,5 %	≤ 0,5 %	
Bulk mechanical characteristics		Breaking strength Sforzo di rottura	S ≥ 700N (for thickness < 7,5 mm - per spessore < 7,5 mm) S ≥ 1300N (for thickness ≥ 7,5 mm - per spessore ≥ 7,5 mm)			S ≥ 1500 N	S ≥ 1000 N	S ≥ 1500 N	S ≥ 1000 N	S ≥ 1500 N	S ≥ 1500 N	
		Modulus of rupture Resistenza alla flessione	R ≥ 35 N/mm ²			R ≥ 40 N/mm ²	R ≥ 40 N/mm ²	R ≥ 40 N/mm ²	R ≥ 45 N/mm ²	R ≥ 40 N/mm ²	R ≥ 40 N/mm ²	
		Bending strength and breaking load Resistenza a flessione e al carico di rottura (4)(5)	EN 1339 Annex F	-			-	-	-	≥ T11 60x60	≥ U4 60x120	-
Surface mechanical characteristics		Impact resistance, as coefficient of restitution Resistenza all'impatto, espresso come coefficiente di restituzione	Declared value Valore dichiarato			≥ 0,55	≥ 0,55	≥ 0,55	≥ 0,55	≥ 0,55	≥ 0,55	
		Mohs hardness Durezza Mohs	EN 101	-			6	6	7	8	6	6
Thermal and hygrometric characteristics		Resistance to deep abrasion of unglazed tiles (removed volume) Resistenza all'abrasione profonda delle piastrelle non smaltate (volume materiale asportato)	ISO 10545-6	≤ 175 mm ³			≤ 150 mm ³	≤ 150 mm ³	≤ 150 mm ³	≤ 150 mm ³	≤ 150 mm ³	≤ 150 mm ³
		Coefficient of thermal linear expansion Coefficiente di dilatazione termica lineare	ISO 10545-8	Declared value Valore dichiarato			≤ 7 MK ⁻¹	≤ 7 MK ⁻¹	≤ 7 MK ⁻¹	≤ 7 MK ⁻¹	≤ 7 MK ⁻¹	≤ 7 MK ⁻¹
		Thermal shock resistance Resistenza agli sbalzi termici	ISO 10545-9	Pass according to EN ISO 10545-1 Test superato in accordo con ISO 10545-1			Resistant Resiste	Resistant Resiste	Resistant Resiste	Resistant Resiste	Resistant Resiste	Resistant Resiste
		Moisture expansion (in mm/m) Dilatazione all'umidità (in mm/m)	ISO 10545-10	Declared value Valore dichiarato			≤ 0,01% (0,1mm/m)	≤ 0,01% (0,1mm/m)	≤ 0,01% (0,1mm/m)	≤ 0,01% (0,1mm/m)	≤ 0,01% (0,1mm/m)	≤ 0,01% (0,1mm/m)
		Frost resistance Resistenza al gelo	ISO 10545-12	Pass according to EN ISO 10545-1 Test superato in accordo con ISO 10545-1			Resistant Resiste	Resistant Resiste	Resistant Resiste	Resistant Resiste	Resistant Resiste	Resistant Resiste
Physical properties		Bond strength/adhesion for improved cementitious adhesives Adezione a trazione con adesivi cementizi migliorati	EN 1348	Declared value Valore dichiarato			≥ 1,0 N/mm ² (Class C2 - EN 12004)	≥ 1,0 N/mm ² (Class C2 - EN 12004)	≥ 1,0 N/mm ² (Class C2 - EN 12004)	≥ 1,0 N/mm ² (Class C2 - EN 12004)	≥ 1,0 N/mm ² (Class C2 - EN 12004)	
		Reaction to fire Reazione al fuoco	-	Class A1 or A1 Classe A1 oppure A1 _{fl}			A1 - A1 _{fl}	A1 - A1 _{fl}	A1 - A1 _{fl}	A1 - A1 _{fl}	A1 - A1 _{fl}	A1 - A1 _{fl}
Chemical characteristics		Resistance to household chemicals and swimming pool salts Resistenza ai prodotti chimici di uso domestico ed agli additivi per piscina	ISO 10545-13	Minimum Class B Classe minima B			A	A	A	A	A	A
		Resistance to low concentrations of acids and alkalis Resistenza a basse concentrazioni di acidi e alcali		Declared Class Classe dichiarata			LA	LA	LA	LA	LA	LA
		Resistance to high concentrations of acids and alkalis Resistenza ad alte concentrazioni di acidi e alcali		Declared Class Classe dichiarata			HA	HA	HA	HA	HA	HA
Safety characteristics (1)(2)		Shod Ramp Test Metodo della rampa "calzata"	DIN 51130	Declared value Valore dichiarato			R10	R9	R11	R11	R10	
		Barefoot Ramp Test Metodo della rampa a piedi nudi	DIN 51097	Declared value Valore dichiarato			A+B	A	A+B+C	A+B+C	A	
		Pendulum Friction Test Metodo del Pendolo	BS 7976	PTV ≥ 36 classifies the surface as "low slip risk"			≥ 36 Dry ≥ 36 Wet	(●)	≥ 36 Dry ≥ 36 Wet	≥ 36 Dry ≥ 36 Wet	≥ 36 Dry ≥ 36 Wet	≥ 36 Dry ≥ 36 Wet
			AS 4586	Declared Classification of the new pedestrian surface materials according to the Pendulum Test			Class P3	(●●)	Class P4	Class P4	Class P3	Class P3
			UNE-ENV 12633	Declared value Valore dichiarato			Class C2	(●●●)	Class C3	Class C3	(●●●)	Class C3
		Coefficient of friction (COF) Coefficiente di attrito	B.C.R.A. Rep. CEC/81	D. M. 236/89 del 14/06/89 μ > 0,40 per elemento scivolante cuoio su pavimentazione asciutta μ > 0,40 per elemento scivolante gomma dura su pavimentazione bagnata			> 0,40 Asciutto > 0,40 Bagnato	> 0,40 Asciutto > 0,40 Bagnato	> 0,40 Asciutto > 0,40 Bagnato	> 0,40 Asciutto > 0,40 Bagnato	> 0,40 Asciutto > 0,40 Bagnato	> 0,40 Asciutto > 0,40 Bagnato
Dynamic coefficient of friction (DCOF) Coefficiente di attrito dinamico	ANSI A137.1	ANSI A.137.1-2017 Requires a minimum value of 0.42 for level interior space expected to be walked upon when wet. (3)			> 0,42 Wet	> 0,42 Wet	> 0,42 Wet	> 0,42 Wet	> 0,42 Wet	> 0,42 Wet		

MARVEL				MARVEL GEMS	MARVEL DREAM					MARVEL EDGE			MARVEL PRO					
Matte	Matte ✦6mm	Polished	Polished ✦6mm	Matte	Matte 60x60 cm	Matte	Matte ✦6mm	Polished	Polished ✦6mm (1)	Matte	Polished ✦6mm	Polished	Matte	Matte ✦6mm	Polished	Polished ✦6mm	Textured	
Suitable for Conforme	Suitable for Conforme	Suitable for Conforme	Suitable for Conforme	Suitable for Conforme	Suitable for Conforme	Suitable for Conforme	Suitable for Conforme	Suitable for Conforme	Suitable for Conforme	Suitable for Conforme	Suitable for Conforme	Suitable for Conforme	Suitable for Conforme	Suitable for Conforme	Suitable for Conforme	Suitable for Conforme	Suitable for Conforme	Suitable for Conforme
Suitable for Conforme	Suitable for Conforme	Suitable for Conforme	Suitable for Conforme	Suitable for Conforme	Suitable for Conforme	Suitable for Conforme	Suitable for Conforme	Suitable for Conforme	Suitable for Conforme	Suitable for Conforme	Suitable for Conforme	Suitable for Conforme	Suitable for Conforme	Suitable for Conforme	Suitable for Conforme	Suitable for Conforme	Suitable for Conforme	Suitable for Conforme
Suitable for Conforme	Suitable for Conforme	Suitable for Conforme	Suitable for Conforme	Suitable for Conforme	Suitable for Conforme	Suitable for Conforme	Suitable for Conforme	Suitable for Conforme	Suitable for Conforme	Suitable for Conforme	Suitable for Conforme	Suitable for Conforme	Suitable for Conforme	Suitable for Conforme	Suitable for Conforme	Suitable for Conforme	Suitable for Conforme	Suitable for Conforme
Suitable for Conforme	Suitable for Conforme	Suitable for Conforme	Suitable for Conforme	Suitable for Conforme	Suitable for Conforme	Suitable for Conforme	Suitable for Conforme	Suitable for Conforme	Suitable for Conforme	Suitable for Conforme	Suitable for Conforme	Suitable for Conforme	Suitable for Conforme	Suitable for Conforme	Suitable for Conforme	Suitable for Conforme	Suitable for Conforme	Suitable for Conforme
Suitable for Conforme	Suitable for Conforme	Suitable for Conforme	Suitable for Conforme	Suitable for Conforme	Suitable for Conforme	Suitable for Conforme	Suitable for Conforme	Suitable for Conforme	Suitable for Conforme	Suitable for Conforme	Suitable for Conforme	Suitable for Conforme	Suitable for Conforme	Suitable for Conforme	Suitable for Conforme	Suitable for Conforme	Suitable for Conforme	Suitable for Conforme
≤ 0,1 %	≤ 0,1 %	≤ 0,1 %	≤ 0,1 %	≤ 0,1 %	≤ 0,1 %	≤ 0,1 %	≤ 0,1 %	≤ 0,1 %	≤ 0,1 %	≤ 0,1 %	≤ 0,1 %	≤ 0,1 %	≤ 0,1 %	≤ 0,1 %	≤ 0,1 %	≤ 0,1 %	≤ 0,1 %	≤ 0,1 %
≤ 0,5 %	≤ 0,5 %	≤ 0,5 %	≤ 0,5 %	≤ 0,5 %	≤ 0,5 %	≤ 0,5 %	≤ 0,5 %	≤ 0,5 %	≤ 0,5 %	≤ 0,5 %	≤ 0,5 %	≤ 0,5 %	≤ 0,5 %	≤ 0,5 %	≤ 0,5 %	≤ 0,5 %	≤ 0,5 %	≤ 0,5 %
S ≥ 1500 N	S ≥ 1000 N	S ≥ 1500 N	S ≥ 1000 N	S ≥ 1500 N	S ≥ 1500 N	S ≥ 1500 N	S ≥ 1000 N	S ≥ 1500 N	S ≥ 1000 N	S ≥ 1500 N	S ≥ 1000 N	S ≥ 1500 N	S ≥ 1500 N	S ≥ 1000 N	S ≥ 1500 N	S ≥ 1000 N	S ≥ 1500 N	S ≥ 1500 N
R ≥ 40 N/mm ²	R ≥ 40 N/mm ²	R ≥ 40 N/mm ²	R ≥ 40 N/mm ²	R ≥ 40 N/mm ²	R ≥ 40 N/mm ²	R ≥ 40 N/mm ²	R ≥ 40 N/mm ²	R ≥ 40 N/mm ²	R ≥ 40 N/mm ²	R ≥ 40 N/mm ²	R ≥ 40 N/mm ²	R ≥ 40 N/mm ²	R ≥ 40 N/mm ²	R ≥ 40 N/mm ²	R ≥ 40 N/mm ²	R ≥ 40 N/mm ²	R ≥ 40 N/mm ²	R ≥ 40 N/mm ²
≥ 0,55	≥ 0,55	≥ 0,55	≥ 0,55	≥ 0,55	≥ 0,55	≥ 0,55	≥ 0,55	≥ 0,55	≥ 0,55	≥ 0,55	≥ 0,55	≥ 0,55	≥ 0,55	≥ 0,55	≥ 0,55	≥ 0,55	≥ 0,55	≥ 0,55
6	6	5	5	6	6	6	6	5	5	6	5	5	6	6	5	5	7	6
≤ 150 mm ³	≤ 150 mm ³	≤ 150 mm ³	≤ 150 mm ³	≤ 150 mm ³	≤ 150 mm ³	≤ 150 mm ³	≤ 150 mm ³	≤ 150 mm ³	≤ 150 mm ³	≤ 150 mm ³	≤ 150 mm ³	≤ 150 mm ³	≤ 150 mm ³	≤ 150 mm ³	≤ 150 mm ³	≤ 150 mm ³	≤ 150 mm ³	≤ 150 mm ³
≤ 7 MK ⁻¹	≤ 7 MK ⁻¹	≤ 7 MK ⁻¹	≤ 7 MK ⁻¹	≤ 7 MK ⁻¹	≤ 7 MK ⁻¹	≤ 7 MK ⁻¹	≤ 7 MK ⁻¹	≤ 7 MK ⁻¹	≤ 7 MK ⁻¹	≤ 7 MK ⁻¹	≤ 7 MK ⁻¹	≤ 7 MK ⁻¹	≤ 7 MK ⁻¹	≤ 7 MK ⁻¹	≤ 7 MK ⁻¹	≤ 7 MK ⁻¹	≤ 7 MK ⁻¹	≤ 7 MK ⁻¹
Resistant Resiste	Resistant Resiste	Resistant Resiste	Resistant Resiste	Resistant Resiste	Resistant Resiste	Resistant Resiste	Resistant Resiste	Resistant Resiste	Resistant Resiste	Resistant Resiste	Resistant Resiste	Resistant Resiste	Resistant Resiste	Resistant Resiste	Resistant Resiste	Resistant Resiste	Resistant Resiste	Resistant Resiste
≤ 0,01% (0,1mm/m)	≤ 0,01% (0,1mm/m)	≤ 0,01% (0,1mm/m)	≤ 0,01% (0,1mm/m)	≤ 0,01% (0,1mm/m)	≤ 0,01% (0,1mm/m)	≤ 0,01% (0,1mm/m)	≤ 0,01% (0,1mm/m)	≤ 0,01% (0,1mm/m)	≤ 0,01% (0,1mm/m)	≤ 0,01% (0,1mm/m)	≤ 0,01% (0,1mm/m)	≤ 0,01% (0,1mm/m)	≤ 0,01% (0,1mm/m)	≤ 0,01% (0,1mm/m)	≤ 0,01% (0,1mm/m)	≤ 0,01% (0,1mm/m)	≤ 0,01% (0,1mm/m)	≤ 0,01% (0,1mm/m)
Resistant Resiste	Resistant Resiste	Resistant Resiste	Resistant Resiste	Resistant Resiste	Resistant Resiste	Resistant Resiste	Resistant Resiste	Resistant Resiste	Resistant Resiste	Resistant Resiste	Resistant Resiste	Resistant Resiste	Resistant Resiste	Resistant Resiste	Resistant Resiste	Resistant Resiste	Resistant Resiste	Resistant Resiste
≥ 1,0 N/mm ² (Class C2 - EN 12004)	≥ 1,0 N/mm ² (Class C2 - EN 12004)	≥ 1,0 N/mm ² (Class C2 - EN 12004)	≥ 1,0 N/mm ² (Class C2 - EN 12004)	≥ 1,0 N/mm ² (Class C2 - EN 12004)	≥ 1,0 N/mm ² (Class C2 - EN 12004)	≥ 1,0 N/mm ² (Class C2 - EN 12004)	≥ 1,0 N/mm ² (Class C2 - EN 12004)	≥ 1,0 N/mm ² (Class C2 - EN 12004)	≥ 1,0 N/mm ² (Class C2 - EN 12004)	≥ 1,0 N/mm ² (Class C2 - EN 12004)	≥ 1,0 N/mm ² (Class C2 - EN 12004)	≥ 1,0 N/mm ² (Class C2 - EN 12004)	≥ 1,0 N/mm ² (Class C2 - EN 12004)	≥ 1,0 N/mm ² (Class C2 - EN 12004)	≥ 1,0 N/mm ² (Class C2 - EN 12004)	≥ 1,0 N/mm ² (Class C2 - EN 12004)	≥ 1,0 N/mm ² (Class C2 - EN 12004)	≥ 1,0 N/mm ² (Class C2 - EN 12004)
A1 - A1 _{fl}	A1 - A1 _{fl}	A1 - A1 _{fl}	A1 - A1 _{fl}	A1 - A1 _{fl}	A1 - A1 _{fl}	A1 - A1 _{fl}	A1 - A1 _{fl}	A1 - A1 _{fl}	A1 - A1 _{fl}	A1 - A1 _{fl}	A1 - A1 _{fl}	A1 - A1 _{fl}	A1 - A1 _{fl}	A1 - A1 _{fl}	A1 - A1 _{fl}	A1 - A1 _{fl}	A1 - A1 _{fl}	A1 - A1 _{fl}
A	A	A	A	A	A	A	A	A	A	A	A	A	A	A	A	A	A	A
LA	LA	LA	LA	LA	LA	LA	LA	LA	LA	LA	LA	LA	LA	LA	LA	LA	LA	LA
HA	HA	-	-	HA	HA	HA	HA	-	-	HA	-	-	HA	HA	-	-	HA	HA
5	5	5	5	5	5	5	5	5	5	5	5	5	5	5	5	5	5	5
R9	R9	N.C.	N.C.	R10	R10	R9	R9	N.C.	N.C.	R9	N.C.	N.C.	R9	R9	N.C.	N.C.	R11	R10
A	A	0	0	A	A+B	A	A	0	0	A	0	0	A	A	0	0	A+B	A
(●)	(●)	≥ 36 Dry ≤ 24 Wet	≥ 36 Dry ≤ 24 Wet	≥ 36 Dry ≥ 36 Wet	≥ 36 Dry ≥ 36 Wet	(●)	(●)	≥ 36 Dry ≤ 24 Wet	≥ 36 Dry ≤ 24 Wet	(●)	≥ 36 Dry ≤ 24 Wet	≥ 36 Dry ≤ 24 Wet	(●)	(●)	≥ 36 Dry ≤ 24 Wet	≥ 36 Dry ≤ 24 Wet	≥ 36 Dry ≥ 36 Wet	≥ 36 Dry ≥ 36 Wet
(●●)	(●●)	-	-	Class P3	Class P3	(●●)	(●●)	-	-	(●●)	-	-	(●●)	(●●)	-	-	Class P4	Class P4
(●●●)	(●●●)	-	-	(●●●)	Class C2	(●●●)	(●●●)	-	-	(●●●)	-	-	(●●●)	(●●●)	-	-	Class C3	Class C3
> 0,40 Asciutto > 0,40 Bagnato	> 0,40 Asciutto > 0,40 Bagnato	> 0,40 Asciutto > 0,40 Bagnato	> 0,40 Asciutto > 0,40 Bagnato															

		Requirements for nominal size N Requisiti per dimensione nominale N			PRISM		RAW			
		7 cm ≤ N < 15 cm		N ≥ 15 cm	Grip	Outdoor ✂ 20mm	Matte	Matte ✂ 6mm	Grip	
		(mm)	(%)	(mm)						
Regularity characteristics		Length and width Lunghezza e larghezza	± 0,9 (*) Non-rect. ± 0,4 (*) Rect.	± 0,6 (*) Non-rect. ± 0,3 (*) Rect.	± 2,0 (*) Non-rect. ± 1,0 (*) Rect.	Suitable for Conforme	Suitable for Conforme	Suitable for Conforme	Suitable for Conforme	Suitable for Conforme
		Thickness Spessore	± 0,5 (**)	± 0,5 (**)	± 0,5 (**)	Suitable for Conforme	Suitable for Conforme	Suitable for Conforme	Suitable for Conforme	Suitable for Conforme
		Straightness of sides Rettilinearità degli spigoli	± 0,8 (***) Non-rect. ± 0,4 (***) Rect.	± 0,5 (***) Non-rect. ± 0,3 (***) Rect.	± 1,5 (***) Non-rect. ± 0,8 (***) Rect.	Suitable for Conforme	Suitable for Conforme	Suitable for Conforme	Suitable for Conforme	Suitable for Conforme
		Rectangularity (Measurement only on short edges when L/I ≥ 3) Ortogonalità (Misurazione da condurre solo sui lati corti quando L/I ≥ 3)	± 0,8 (****) Non-rect. ± 0,4 (****) Rect.	± 0,5 (****) Non-rect. ± 0,3 (****) Rect.	± 2,0 (****) Non-rect. ± 1,5 (****) Rect.	Suitable for Conforme	Suitable for Conforme	Suitable for Conforme	Suitable for Conforme	Suitable for Conforme
Structural characteristics		Surface flatness Planarità	c.c. ± 0,8 Non-rect. c.c. ± 0,6 Rect. e.c. ± 0,8 Non-rect. e.c. ± 0,6 Rect. w. ± 0,8 Non-rect. w. ± 0,6 Rect.	c.c. ± 0,5 Non-rect. c.c. ± 0,4 Rect. e.c. ± 0,5 Non-rect. e.c. ± 0,4 Rect. w. ± 0,5 Non-rect. w. ± 0,4 Rect.	c.c. ± 2,0 Non-rect. c.c. ± 1,8 Rect. e.c. ± 2,0 Non-rect. e.c. ± 1,8 Rect. w. ± 2,0 Non-rect. w. ± 1,8 Rect.	Suitable for Conforme	Suitable for Conforme	Suitable for Conforme	Suitable for Conforme	Suitable for Conforme
		Water absorption (in % by mass) Massa d'acqua assorbita (come % della massa)	ISO 10545-3	E _v ≤ 0,5% Individual max 0,6% E _v ≤ 0,5% Valore max singolo 0,6%	≤ 0,1 %	≤ 0,1 %	≤ 0,1 %	≤ 0,1 %	≤ 0,1 %	
Bulk mechanical characteristics		Breaking strength Sforzo di rottura	ISO 10545-3	Requirement ANSI A137.1 Water Absorption Max ≤ 0,5%	≤ 0,5 %	≤ 0,5 %	≤ 0,5 %	≤ 0,5 %	≤ 0,5 %	
		Modulus of rupture Resistenza alla flessione	ISO 10545-4	S ≥ 700N (for thickness < 7,5 mm - per spessore < 7,5 mm) S ≥ 1300N (for thickness ≥ 7,5 mm - per spessore ≥ 7,5 mm)	S ≥ 1500 N	S ≥ 10000 N	S ≥ 1500 N	S ≥ 1000 N	S ≥ 1500 N	
		Bending strength and breaking load Resistenza a flessione e al carico di rottura (4)(5)	EN 1339 Annex F	-	R ≥ 40 N/mm ²	R ≥ 45 N/mm ²	R ≥ 40 N/mm ²	R ≥ 40 N/mm ²	R ≥ 40 N/mm ²	
Surface mechanical characteristics		Impact resistance, as coefficient of restitution Resistenza all'impatto, espresso come coefficiente di restituzione	ISO 10545-5	Declared value Valore dichiarato	≥ 0,55	≥ 0,55	≥ 0,55	≥ 0,55	≥ 0,55	
		Mohs hardness Durezza Mohs	EN 101	-	8	8	6	6	8	
Thermal and hygrometric characteristics		Resistance to deep abrasion of unglazed tiles (removed volume) Resistenza all'abrasione profonda delle piastrelle non smaltate (volume materiale asportato)	ISO 10545-6	≤ 175 mm ³	≤ 150 mm ³	≤ 150 mm ³	≤ 150 mm ³	≤ 150 mm ³	≤ 150 mm ³	
		Coefficient of thermal linear expansion Coefficiente di dilatazione termica lineare	ISO 10545-8	Declared value Valore dichiarato	≤ 7 MK ⁻¹	≤ 7 MK ⁻¹	≤ 7 MK ⁻¹	≤ 7 MK ⁻¹	≤ 7 MK ⁻¹	
Physical properties		Thermal shock resistance Resistenza agli sbalzi termici	ISO 10545-9	Pass according to EN ISO 10545-1 Test superato in accordo con ISO 10545-1	Resistant Resiste	Resistant Resiste	Resistant Resiste	Resistant Resiste	Resistant Resiste	
		Moisture expansion (in mm/m) Dilatazione all'umidità (in mm/m)	ISO 10545-10	Declared value Valore dichiarato	≤ 0,01% (0,1mm/m)	≤ 0,01% (0,1mm/m)	≤ 0,01% (0,1mm/m)	≤ 0,01% (0,1mm/m)	≤ 0,01% (0,1mm/m)	
		Frost resistance Resistenza al gelo	ISO 10545-12	Pass according to EN ISO 10545-1 Test superato in accordo con ISO 10545-1	Resistant Resiste	Resistant Resiste	Resistant Resiste	Resistant Resiste	Resistant Resiste	
Chemical characteristics		Bond strength/adhesion for improved cementitious adhesives Adesione a trazione con adesivi cementizi migliorati	EN 1348	Declared value Valore dichiarato	≥ 1,0 N/mm ² (Class C2 - EN 12004)	≥ 1,0 N/mm ² (Class C2 - EN 12004)	≥ 1,0 N/mm ² (Class C2 - EN 12004)	≥ 1,0 N/mm ² (Class C2 - EN 12004)	≥ 1,0 N/mm ² (Class C2 - EN 12004)	
		Reaction to fire Reazione al fuoco	-	Class A1 or A1 _n Classe A1 oppure A1 _n	A1 - A1 _n	A1 - A1 _n	A1 - A1 _n	A1 - A1 _n	A1 - A1 _n	
Safety characteristics (1)(2)		Resistance to household chemicals and swimming pool salts Resistenza ai prodotti chimici di uso domestico ed agli additivi per piscina	ISO 10545-13	Minimum Class B Classe minima B	A	A	A	A	A	
		Resistance to low concentrations of acids and alkalis Resistenza a basse concentrazioni di acidi e alcali	ISO 10545-13	Declared Class Classe dichiarata	LA	LA	LA	LA	LA	
		Resistance to high concentrations of acids and alkalis Resistenza ad alte concentrazioni di acidi e alcali	ISO 10545-13	Declared Class Classe dichiarata	HA	HA	HA	HA	HA	
Safety characteristics (1)(2)		Resistance to staining, for unglazed tiles Resistenza alle macchie per piastrelle non smaltate	ISO 10545-14	Declared Class Classe dichiarata	5	5	5	5	5	
		Shod Ramp Test Metodo della rampa "calzata"	DIN 51130	Declared value Valore dichiarato	R11	R11	R10	R9	R11	
		Barefoot Ramp Test Metodo della rampa a piedi nudi	DIN 51097	Declared value Valore dichiarato	A+B+C	A+B+C	A+B	A	A+B+C	
		Pendulum Friction Test Metodo del Pendolo	BS 7976	PTV ≥ 36 classifies the surface as "low slip risk"	≥ 36 Dry ≥ 36 Wet	≥ 36 Dry ≥ 36 Wet	≥ 36 Dry ≥ 36 Wet	(●)	≥ 36 Dry ≥ 36 Wet	
			AS 4586	Declared Classification of the new pedestrian surface materials according to the Pendulum Test	Class P4	Class P4	Class P3	(●●)	Class P4	
			UNE-ENV 12633	Declared value Valore dichiarato	Class C3	Class C3	Class C2	(●●●)	Class C3	
Safety characteristics (1)(2)		Coefficient of friction (COF) Coefficiente di attrito	B.C.R.A. Rep. CEC/81	D. M. 236/89 del 14/06/89 μ > 0,40 per elemento scivolante cuoio su pavimentazione asciutta μ > 0,40 per elemento scivolante gomma dura su pavimentazione bagnata	> 0,40 Asciutto > 0,40 Bagnato	> 0,40 Asciutto > 0,40 Bagnato	> 0,40 Asciutto > 0,40 Bagnato	> 0,40 Asciutto > 0,40 Bagnato		
		Dynamic coefficient of friction (DCOF) Coefficiente di attrito dinamico	ANSI A137.1	ANSI A137.1-2017 Requires a minimum value of 0.42 for level interior space expected to be walked upon when wet. (3)	> 0,42 Wet	> 0,42 Wet	> 0,42 Wet	> 0,42 Wet	> 0,42 Wet	

RAW	SEASTONE	SUNROCK	TRUST			VENTI BOOST	
Outdoor ✂ 20mm	Matte	Outdoor ✂ 20mm	Outdoor ✂ 20mm	Matte	Grip	Outdoor ✂ 20mm*	Matte
Suitable for Conforme	Suitable for Conforme	Suitable for Conforme	Suitable for Conforme	Suitable for Conforme	Suitable for Conforme	Suitable for Conforme	Suitable for Conforme
Suitable for Conforme	Suitable for Conforme	Suitable for Conforme	Suitable for Conforme	Suitable for Conforme	Suitable for Conforme	Suitable for Conforme	Suitable for Conforme
Suitable for Conforme	Suitable for Conforme	Suitable for Conforme	Suitable for Conforme	Suitable for Conforme	Suitable for Conforme	Suitable for Conforme	Suitable for Conforme
Suitable for Conforme	Suitable for Conforme	Suitable for Conforme	Suitable for Conforme	Suitable for Conforme	Suitable for Conforme	Suitable for Conforme	Suitable for Conforme
Suitable for Conforme	Suitable for Conforme	Suitable for Conforme	Suitable for Conforme	Suitable for Conforme	Suitable for Conforme	Suitable for Conforme	Suitable for Conforme
Suitable for Conforme	Suitable for Conforme	Suitable for Conforme	Suitable for Conforme	Suitable for Conforme	Suitable for Conforme	Suitable for Conforme	Suitable for Conforme
Suitable for Conforme	Suitable for Conforme	Suitable for Conforme	Suitable for Conforme	Suitable for Conforme	Suitable for Conforme	Suitable for Conforme	Suitable for Conforme
Suitable for Conforme	Suitable for Conforme	Suitable for Conforme	Suitable for Conforme	Suitable for Conforme	Suitable for Conforme	Suitable for Conforme	Suitable for Conforme
Suitable for Conforme	Suitable for Conforme	Suitable for Conforme	Suitable for Conforme	Suitable for Conforme	Suitable for Conforme	Suitable for Conforme	Suitable for Conforme
Suitable for Conforme	Suitable for Conforme	Suitable for Conforme	Suitable for Conforme	Suitable for Conforme	Suitable for Conforme	Suitable for Conforme	Suitable for Conforme
Suitable for Conforme	Suitable for Conforme	Suitable for Conforme	Suitable for Conforme	Suitable for Conforme	Suitable for Conforme	Suitable for Conforme	Suitable for Conforme
Suitable for Conforme	Suitable for Conforme	Suitable for Conforme	Suitable for Conforme	Suitable for Conforme	Suitable for Conforme	Suitable for Conforme	Suitable for Conforme
Suitable for Conforme	Suitable for Conforme	Suitable for Conforme	Suitable for Conforme	Suitable for Conforme	Suitable for Conforme	Suitable for Conforme	Suitable for Conforme
Suitable for Conforme	Suitable for Conforme	Suitable for Conforme	Suitable for Conforme	Suitable for Conforme	Suitable for Conforme	Suitable for Conforme	Suitable for Conforme
Suitable for Conforme	Suitable for Conforme	Suitable for Conforme	Suitable for Conforme	Suitable for Conforme	Suitable for Conforme	Suitable for Conforme	Suitable for Conforme
Suitable for Conforme	Suitable for Conforme	Suitable for Conforme	Suitable for Conforme	Suitable for Conforme	Suitable for Conforme	Suitable for Conforme	Suitable for Conforme
Suitable for Conforme	Suitable for Conforme	Suitable for Conforme	Suitable for Conforme	Suitable for Conforme	Suitable for Conforme	Suitable for Conforme	Suitable for Conforme
Suitable for Conforme	Suitable for Conforme	Suitable for Conforme	Suitable for Conforme	Suitable for Conforme	Suitable for Conforme	Suitable for Conforme	Suitable for Conforme
Suitable for Conforme	Suitable for Conforme	Suitable for Conforme	Suitable for Conforme	Suitable for Conforme	Suitable for Conforme	Suitable for Conforme	Suitable for Conforme
Suitable for Conforme	Suitable for Conforme	Suitable for Conforme	Suitable for Conforme	Suitable for Conforme	Suitable for Conforme	Suitable for Conforme	Suitable for Conforme
Suitable for Conforme	Suitable for Conforme	Suitable for Conforme	Suitable for Conforme	Suitable for Conforme	Suitable for Conforme	Suitable for Conforme	Suitable for Conforme
Suitable for Conforme	Suitable for Conforme	Suitable for Conforme	Suitable for Conforme	Suitable for Conforme	Suitable for Conforme	Suitable for Conforme	Suitable for Conforme
Suitable for Conforme	Suitable for Conforme	Suitable for Conforme	Suitable for Conforme	Suitable for Conforme	Suitable for Conforme	Suitable for Conforme	Suitable for Conforme
Suitable for Conforme	Suitable for Conforme	Suitable for Conforme	Suitable for Conforme	Suitable for Conforme	Suitable for Conforme	Suitable for Conforme	Suitable for Conforme
Suitable for Conforme	Suitable for Conforme	Suitable for Conforme	Suitable for Conforme	Suitable for Conforme	Suitable for Conforme	Suitable for Conforme	Suitable for Conforme
Suitable for Conforme	Suitable for Conforme	Suitable for Conforme	Suitable for Conforme	Suitable for Conforme	Suitable for Conforme	Suitable for Conforme	Suitable for Conforme
Suitable for Conforme	Suitable for Conforme	Suitable for Conforme	Suitable for Conforme	Suitable for Conforme	Suitable for Conforme	Suitable for Conforme	Suitable for Conforme
Suitable for Conforme	Suitable for Conforme	Suitable for Conforme	Suitable for Conforme	Suitable for Conforme	Suitable for Conforme	Suitable for Conforme	Suitable for Conforme
Suitable for Conforme	Suitable for Conforme	Suitable for Conforme	Suitable for Conforme	Suitable for Conforme	Suitable for Conforme	Suitable for Conforme	Suitable for Conforme
Suitable for Conforme	Suitable for Conforme	Suitable for Conforme	Suitable for Conforme	Suitable for Conforme	Suitable for Conforme	Suitable for Conforme	Suitable for Conforme
Suitable for Conforme	Suitable for Conforme	Suitable for Conforme	Suitable for Conforme	Suitable for Conforme	Suitable for Conforme	Suitable for Conforme	Suitable for Conforme
Suitable for Conforme	Suitable for Conforme	Suitable for Conforme	Suitable for Conforme	Suitable for Conforme	Suitable for Conforme	Suitable for Conforme	Suitable for Conforme
Suitable for Conforme	Suitable for Conforme	Suitable for Conforme	Suitable for Conforme	Suitable for Conforme	Suitable for Conforme	Suitable for Conforme	Suitable for Conforme
Suitable for Conforme	Suitable for Conforme	Suitable for Conforme	Suitable for Conforme	Suitable for Conforme	Suitable for Conforme	Suitable for Conforme	Suitable for Conforme
Suitable for Conforme	Suitable for Conforme	Suitable for Conforme	Suitable for Conforme	Suitable for Conforme	Suitable for Conforme	Suitable for Conforme	Suitable for Conforme
Suitable for Conforme	Suitable for Conforme	Suitable for Conforme	Suitable for Conforme	Suitable for Conforme	Suitable for Conforme	Suitable for Conforme	Suitable for Conforme
Suitable for Conforme	Suitable for Conforme	Suitable for Conforme	Suitable for Conforme	Suitable for Conforme	Suitable for Conforme	Suitable for Conforme	Suitable for Conforme
Suitable for Conforme	Suitable for Conforme	Suitable for Conforme	Suitable for Conforme	Suitable for Conforme	Suitable for Conforme	Suitable for Conforme	Suitable for Conforme
Suitable for Conforme	Suitable for Conforme	Suitable for Conforme	Suitable for Conforme	Suitable for Conforme	Suitable for Conforme	Suitable for Conforme	Suitable for Conforme
Suitable for Conforme	Suitable for Conforme	Suitable for Conforme	Suitable for Conforme	Suitable for Conforme	Suitable for Conforme	Suitable for Conforme	Suitable for Conforme
Suitable for Conforme	Suitable for Conforme	Suitable for Conforme	Suitable for Conforme	Suitable for Conforme	Suitable for Conforme	Suitable for Conforme	Suitable for Conforme
Suitable for Conforme	Suitable for Conforme	Suitable for Conforme	Suitable for Conforme	Suitable for Conforme	Suitable for Conforme	Suitable for Conforme	Suitable for Conforme
Suitable for Conforme	Suitable for Conforme	Suitable for Conforme	Suitable for Conforme	Suitable for Conforme	Suitable for Conforme	Suitable for Conforme	Suitable for Conforme
Suitable for Conforme	Suitable for Conforme	Suitable for Conforme	Suitable for Conforme	Suitable for Conforme	Suitable for Conforme	Suitable for Conforme	Suitable for Conforme
Suitable for Conforme	Suitable for Conforme	Suitable for Conforme	Suitable for Conforme	Suitable for Conforme	Suitable for Conforme	Suitable for Conforme	Suitable for Conforme
Suitable for Conforme	Suitable for Conforme	Suitable for Conforme	Suitable for Conforme	Suitable for Conforme	Suitable for Conforme	Suitable for Conforme	Suitable for Conforme
Suitable for Conforme	Suitable for Conforme	Suitable for Conforme	Suitable for Conforme	Suitable for Conforme	Suitable for Conforme	Suitable for Conforme	Suitable for Conforme
Suitable for Conforme	Suitable for Conforme	Suitable for Conforme	Suitable for Conforme	Suitable for Conforme	Suitable for Conforme	Suitable for Conforme	Suitable for Conforme
Suitable for Conforme	Suitable for Conforme	Suitable for Conforme	Suitable for Conforme	Suitable for Conforme	Suitable for Conforme	Suitable for Conforme	Suitable for Conforme
Suitable for Conforme	Suitable for Conforme	Suitable for Conforme	Suitable for Conforme	Suitable for Conforme	Suitable for Conforme	Suitable for Conforme	Suitable for Conforme
Suitable for Conforme	Suitable for Conforme	Suitable for Conforme	Suitable for Conforme	Suitable for Conforme	Suitable for Conforme	Suitable for Conforme	Suitable for Conforme
Suitable for Conforme	Suitable for Conforme	Suitable for Conforme	Suitable for Conforme	Suitable for Conforme	Suitable for Conforme	Suitable for Conforme	Suitable for Conforme
Suitable for Conforme	Suitable for Conforme	Suitable for Conforme	Suitable for Conforme	Suitable for Conforme	Suitable for Conforme	Suitable for Conforme	Suitable for Conforme
Suitable for Conforme	Suitable for Conforme	Suitable for Conforme	Suitable for Conforme	Suitable for Conforme	Suitable for Conforme	Suitable for Conforme	Suitable for Conforme
Suitable for Conforme	Suitable for Conforme	Suitable for Conforme	Suitable for Conforme	Suitable for Conforme	Suitable for Conforme	Suitable for Conforme	Suitable for Conforme
Suitable for Conforme	Suitable for Conforme	Suitable for Conforme	Suitable for Conforme	Suitable for Conforme	Suitable for Conforme	Suitable for Conforme	Suitable for Conforme
Suitable for Conforme	Suitable for Conforme	Suitable for Conforme	Suitable for Conforme	Suitable for Conforme	Suitable for Conforme	Suitable for Conforme	Suitable for Conforme
Suitable for Conforme	Suitable for Conforme	Suitable for Conforme	Suitable for Conforme	Suitable for Conforme	Suitable for Conforme	Suitable for Conforme	Suitable for Conforme
Suitable for Conforme	Suitable for Conforme	Suitable for Conforme	Suitable for Conforme	Suitable for Conforme	Suitable for Conforme	Suitable for Conforme	Suitable for Conforme
Suitable for Conforme	Suitable for Conforme	Suitable for Conforme	Suitable for Conforme	Suitable for Conforme	Suitable for Conforme	Suitable for Conforme	Suitable for Conforme
Suitable for Conforme	Suitable for Conforme	Suitable for Conforme	Suitable for Conforme	Suitable for Conforme	Suitable for Conforme	Suitable for Conforme	Suitable for Conforme
Suitable for Conforme	Suitable for Conforme	Suitable for Conforme	Suitable for Conforme	Suitable for Conforme	Suitable for Conforme	Suitable for Conforme	Suitable for Conforme
Suitable for Conforme	Suitable for Conforme	Suitable for Conforme	Suitable for Conforme	Suitable for Conforme	Suitable for Conforme	Suitable for Conforme	Suitable for Conforme
Suitable for Conforme	Suitable for Conforme	Suitable for Conforme	Suitable for Conforme	Suitable for Conforme	Suitable for Conforme	Suitable for Conforme	Suitable for Conforme
Suitable for Conforme	Suitable for Conforme	Suitable for Conforme	Suitable for Conforme	Suitable for Conforme	Suitable for Conforme	Suitable for Conforme	Suitable for Conforme
Suitable for Conforme	Suitable for Conforme	Suitable for Conforme	Suitable for Conforme	Suitable for Conforme	Suitable for Conforme	Suitable for Conforme	Suitable for Conforme
Suitable for Conforme	Suitable for Conforme	Suitable for Conforme	Suitable for Conforme	Suitable for Conforme	Suitable for Conforme	Suitable for Conforme	Suitable for Conforme
Suitable for Conforme	Suitable for Conforme	Suitable for Conforme	Suitable for Conforme	Suitable for Conforme	Suitable for Conforme	Suitable for Conforme	Suitable for Conforme
Suitable for Conforme	Suitable for Conforme	Suitable for Conforme	Suitable for Conforme	Suitable for Conforme	Suitable for Conforme	Suitable for Conforme	Suitable for Conforme
Suitable for Conforme	Suitable for Conforme	Suitable for Conforme	Suitable for Conforme	Suitable for Conforme	Suitable for Conforme	Suitable for Conforme	Suitable for Conforme
Suitable for Conforme	Suitable for Conforme	Suitable for Conforme	Suitable for Conforme	Suitable for Conforme	Suitable for Conforme	Suitable for Conforme	Suitable for Conforme
Suitable for Conforme	Suitable for Conforme	Suitable for Conforme					



COLOURED BODY PORCELAIN TILES - NON RECTIFIED
GRES PORCELLANATO COLORATO IN MASSA - NON RETTIFICATO
Grès cérame coloré dans la masse - Non rectifié
Durchgefärbtes Feinsteinzeug - Nicht rektifiziert
Gres porcelánico coloreado en masa - No rectificada
Керамический гранит окрашенный в массе - Нереттифицированные

			Requirements for nominal size N Requisiti per dimensione nominale N		162x324 cm - 63 ³ / ₁₆ "x127 ¹ / ₂ " Non Rectified		
			N ≥ 15 cm		Silk	Matte Hammered Flamed	Polished Satin
			(%)	(mm)			
Regularity characteristics	Thickness Spessore	ISO 10545-2	± 5 (**)	± 0,5 (**)	± 5,0% ± 0,5 mm		
			c.c. ± 0,5	c.c. ± 2,0	± 0,5% ± 2,0 mm		
	Surface flatness Planarità		e.c. ± 0,5	e.c. ± 2,0			
			w. ± 0,5	w. ± 2,0			
			EN 144T1 annex e; (Group Bla) EN 74477 appendice G (Gruppo Bla)	ISO 13006 annex e; (Group Bla) 150 73006 appendice G (Gruppo Bla)			
Structural characteristics	Water absorption Massa d'acqua assorbita	ISO 10545-3	E _v ≤ 0,5% Individual max 0,6% E _v ≤ 0,5% Valore max singolo 0,6%		≤ 0,1 %		
		ASTM C373	Requirement ANSI A137.1 Water Absorption Max ≤ 0,5%		≤ 0,5 %		
Bulk mechanical characteristics	Breaking strength Sforzo di rottura	ISO 10545-4	S ≥ 700 N for thickness < 7,5mm per spessore < 7,5mm	S ≥ 1300 N for thickness ≥ 7,5mm per spessore ≥ 7,5mm	6 mm -> S ≥ 1000N		
			R ≥ 35 N/mm ²		12 mm -> S ≥ 3500N		
	Modulus of rupture Resistenza alla flessione				20 mm -> S ≥ 10000N		
Surface mechanical characteristics	Mohs hardness Durezza Mohs	EN 101	-		6	6	5
	Resistance to deep abrasion of unglazed tiles (removed volume) Resistenza all'abrasione profonda delle piastrelle non smaltate (volume materiale asportato)	ISO 10545-6	≤ 175 mm ³		≤ 160 mm ³		
Thermal and hygrometric characteristics	Coefficient of thermal linear expansion Coefficiente di dilatazione termica lineare	ISO 10545-8	Declared value Valore dichiarato	Test method available Metodo di prova disponibile	≤ 9 M°C ⁻¹		
	Thermal shock resistance Resistenza agli sbalzi termici	ISO 10545-9	Pass according to EN ISO 10545-1 Test superato in accordo con ISO 10545-1	Test method available Metodo di prova disponibile	Resistant Resiste		
	Moisture expansion (in mm/m) Dilatazione all'umidità (in mm/m)	ISO 10545-10	Declared value Valore dichiarato	Test method available Metodo di prova disponibile	≤ 0,01% (0,1mm/m)		
	Frost resistance Resistenza al gelo	ISO 10545-12	Pass according to EN ISO 10545-1 Test superato in accordo con ISO 10545-1	Required Metodo di prova richiesto	Resistant Resiste		
Physical properties	Bond strength/adhesion for improved cementitious adhesives Adesione a trazione con adesivi cementizi migliorati	EN 1348	Declared value Valore dichiarato	-	≥ 1,0 N/mm ² (Class C2 - EN 12004)		
	Reaction to fire Reazione al fuoco	-	Class A1 Classe A1	-	A1 (without fiberglass) A2 (with fiberglass)		
Chemical characteristics	Resistance to household chemicals and swimming pool salts Resistenza ai prodotti chimici di uso domestico ed agli additivi per piscina	ISO 10545-13	Minimum Class B (U for unglazed tiles) Classe minima B (U per piastrelle non smaltate)		A		
	Resistance to low concentrations of acids and alkalis Resistenza a basse concentrazioni di acidi e alcali		Declared Class Classe dichiarata	Manufacturer is to state classification Secondo la classificazione indicata dal fabbricante	LA	LA	LA
	Resistance to high concentrations of acids and alkalis Resistenza ad alte concentrazioni di acidi e alcali		Declared Class Classe dichiarata	Test method available Metodo di prova disponibile	HA	HA	-
	Resistance to staining Resistenza alle macchie	ISO 10545-14	Declared Class Classe dichiarata	Test method available Metodo di prova disponibile	5		
	Release of dangerous substances: Cadmium (in mg/dm ²) and Lead (in mg/dm ²) Rilascio di sostanze pericolose: Cadmio (in mg/dm ²) e Piombo (in mg/dm ²)	ISO 10545-15	Declared value Valore dichiarato	Test method available Metodo di prova disponibile	≤ 0,01 mg/dm ² Cd ≤ 0,1 mg/dm ² Pb		
	Resistance to scratching Resistenza alla graffiatura	UNI EN 15186:2012 met.B			CEN/TS 16209 Class A CEN/TS 16209 Classe A		
	Tendency to retain dirt Tendenza a ritenere lo sporco	UNI 9300:2015			No visible change (5) Nessun cambiamento visibile (5)		
	Surface resistance to cold liquids Resistenza delle superfici ai liquidi freddi	UNI EN 12720:2013			CEN/TS 16209 Class A CEN/TS 16209 Classe A		
	Surface resistance to wet heat Resistenza delle superfici al calore umido	UNI EN 12721:2013			CEN/TS 16209 Class A CEN/TS 16209 Classe A		
	Surface resistance to dry heat Resistenza delle superfici al calore secco	UNI EN 12722:2013			CEN/TS 16209 Class A CEN/TS 16209 Classe A		
	Assessment of resistance to impact Resistenza all'urto	ISO 4211-4:1988			Maximum drop height according to thickness. Altezza massima di caduta variabile in funzione dello spessore.		



ARBOR Porcelain tiles (15x90 cm)

ARKSHADE Porcelain tiles

AIX Porcelain tiles

AXI

BOOST Porcelain tiles

BRAVE Porcelain tiles

DOLMEN PRO

DWELL Porcelain tiles

ETIC

ETIC PRO

EVOLVE

GRANIOLIATI

MARK Porcelain tiles

MARVEL Porcelain tiles

MARVEL EDGE Porcelain tiles

MARVEL GEMS Porcelain tiles

MARVEL PRO Porcelain tiles

MARVEL STONE Porcelain tiles

NID Porcelain tiles (15x90 cm)

SEASTONE

SUNROCK

TRUST

VENTI BOOST

Classificazione UPEC/UPEC F+ - in via di certificazione /
Classification UPEC/UPEC F+ - en cours de certification



BLAZE Porcelain tiles

BOOST PRO Porcelain tiles

LIMS Porcelain tiles

PRISM Porcelain tiles

MARVEL SHINE Porcelain tiles

RAW Porcelain tiles

Si consiglia la consultazione della pagina
<http://webapp.cstb.fr/upec-ceramique/index.php?view=TitulaireListeProduits&sid=39&tid=1>
Per ulteriori informazioni scrivere a france@atlasconcorde.it

On vous conseille de vous connecter à:
<http://webapp.cstb.fr/upec-ceramique/index.php?view=TitulaireListeProduits&sid=39&tid=1>
Pour tous renseignements complémentaires merci d'écrire à france@atlasconcorde.it

Destinations of use / Destinazione d'uso

PORCELAIN TILES / GRES PORCELLANATO

Grès cérame / Feinsteinzeug

Gres porcelánico / Керамогранит



HEAVY TRAFFIC
CALPESTIO PESANTE

HEAVY COMMERCIAL

Malls, airports, places of worship, schools, museums, squares, hospitals, hotels - foyers, undergrounds, train stations, etc.

COMMERCIALI PESANTI

Mall, aeroporti, luoghi di culto, scuole, musei, piazze, ospedali, hotel - hall di ingresso, metropolitane, stazioni ferroviarie, ecc...

COMMERCIALI PESANTI

Centres commerciaux, aéroports, lieux de culte, écoles, musées, places, hôpitaux, hôtels - halls d'entrée, stations de métro, gares, etc...

STARK BEANSPRUCHTE GEWERBEBEREICHE

Enkaufszentren, Flughäfen, Kultstätten, Schulen, Museen, Plätze, Krankenhäuser, Hotels - Eingangshallen, U-Bahn-Stationen, Bahnhöfe etc.

COMERCIALES PESADOS

Centros comerciales, aeropuertos, lugares de culto, colegios, museos, plazas, hospitales, hoteles - hall de entrada, metros, estaciones de trenes, etc. ...

ОБЩЕСТВЕННЫЕ ОБЪЕКТЫ С ВЫСОКОЙ ПОСЕЩАЕМОСТЬЮ

Торговые центры, аэропорты, церкви, школы, музеи, площади, больницы, входные холлы отелей, метро, вокзалы и т.п.



MEDIUM TRAFFIC
CALPESTIO MEDIO

MEDIUM COMMERCIAL

Restaurants, offices, shops, public restrooms, public offices, hotels except for foyers, business lounges, etc. with the exception of mandatory passageways and areas subject to the transit of trolleys with hard wheels or highly concentrated loads.

COMMERCIALI MEDI

Ristoranti, uffici, negozi, bagni pubblici, uffici pubblici, hotel - ad esclusione delle hall di ingresso, business lounge, etc. a esclusione di passaggi obbligati e zone soggetto a transito di carrelli con ruote dure ovvero elevati carichi concentrati.

BÂTIMENT COMMERCIAL MOYEN

Restaurants, bureaux, boutiques, sanitaires publics, bureaux publics, hôtels - à l'exception des halls d'entrée, business lounges, etc..., ainsi que des points de passage obligés et des zones soumises au passage de chariots à roues dures ou de charges ponctuelles lourdes.

GEWERBEBEREICHE MIT MITTLERER BEANSPRUCHUNG

Restaurants, Büros, Geschäfte, öffentliche Toiletten, öffentliche Ämter, Hotels mit Ausnahme der Eingangshallen, Business Lounges etc., unter Ausschluss obligatorischer Passagen sowie mit harten Rädern befahrener bzw. hohen, konzentrierten Lasten ausgesetzter Bereiche.

COMERCIALES MEDIOS

Restaurantes, oficinas, tiendas, baños públicos, oficinas públicas, hoteles - excluidos los pasillos de entradas, salas de negocios, etc. excluidos los pasos obligatorios y áreas sujetas al tránsito de carretillas con ruedas duras o cargas altamente concentradas.

ОБЩЕСТВЕННЫЕ ОБЪЕКТЫ СО СРЕДНЕЙ ПОСЕЩАЕМОСТЬЮ

Рестораны, офисы, магазины, общественные туалеты, общественные учреждения, отели (кроме входных холлов), бизнес-залы и т.п., за исключением общих проходов и мест, где предвидятся сосредоточенные нагрузки или перемещение тележек на жестких колесах.



LIGHT TRAFFIC
CALPESTIO LEGGERO

RESIDENTIAL

Bedrooms, living rooms, studies, private kitchens, private bathrooms, etc.

RESIDENZIALI

Camere da letto, soggiorni, studi, cucine private, bagni privati...

BÂTIMENT D'HABITATION

Chambres de nuit, salons, pièces à usage professionnel, cuisines, salles de bains...

WOHNUNGSBAU

Schlafzimmer, Wohnzimmer, Arbeitszimmer, private Küchen und Bäder...

RESIDENCIALES

Dormitorios, salones, salas de estar, cocinas particulares, cuartos de baño particulares...

ЖИЛЫЕ ПОМЕЩЕНИЯ

Спальни, гостиные, рабочие кабинеты, домашние кухни, домашние ванные комнаты и т.п.

RECOMMENDED PRODUCTS BY INTENDED USE / PRODOTTI CONSIGLIATI PER DESTINAZIONE D'USO

PRODUITS CONSEILLÉS PAR DESTINATION D'USAGE / EMPFOHLENE PRODUKTE NACH ZWECKBESTIMMUNG

PRODUCTOS ACONSEJADOS SEGÚN LOS USOS PREVISTOS / ИЗДЕЛИЯ, РЕКОМЕНДУЕМЫЕ В ЗАВИСИМОСТИ ОТ НАЗНАЧЕНИЯ

Heavy commercial, medium commercial and residential. Commerciale pesante, commerciale medio e residenziale.		H M L
ARBOR	matte/grip	✘ 8,5/9 mm
ARKSHADE	matte/grip	✘ 9 mm
AIX	matte/grip/textured	✘ 9/20 mm
AXI	matte/textured	✘ 9,5/20 mm
BLAZE	matte/grip/textured	✘ 9/20 mm
BOOST	matte/grip/textured	✘ 9/20 mm
BOOST PRO	matte/grip/textured	✘ 9/20 mm
BRAVE	matte/grip/textured	✘ 9/20 mm
DOLMEN PRO	matte/grip/textured	✘ 9/20 mm
DWELL	matte/textured	✘ 9/20 mm
ETIC	matte	✘ 9/9,5 mm
ETIC PRO	matte/grip/textured	✘ 9/20 mm
EVOLVE	matte	✘ 9 mm
EXENCE	matte/grip/textured	✘ 9/20 mm
GRANIGLIATI	matte/textured	✘ 7,6/8,6/12 mm
GROUNDTRACK	matte	✘ 9 mm
HEARTWOOD	matte	✘ 9 mm
KLIF	matte/grip/textured	✘ 9/20 mm
KONE	matte/grip/textured	✘ 9/20 mm
LIMS	matte/grip/textured	✘ 9/20 mm
MARK	matte	✘ 9 mm
MARVEL	matte	✘ 9 mm
MARVEL DREAM	matte	✘ 9 mm
MARVEL EDGE	matte	✘ 9 mm
MARVEL GEMS	matte	✘ 9 mm
MARVEL PRO	matte/textured	✘ 9/20 mm
MARVEL SHINE	matte	✘ 9 mm
MARVEL STONE	matte	✘ 9 mm
MEK	matte	✘ 9 mm
NASH	matte/grip	✘ 8,5/9 mm
NID	matte	✘ 9 mm
NORDE	matte/grip/roccia/textured	✘ 9/20 mm
PRISM	matte/grip/textured	✘ 9/20 mm
RAW	matte/grip/textured	✘ 9/20 mm
SEASTONE	matte/textured	✘ 9/20 mm
SUNROCK	textured	✘ 20 mm
TRUST	matte/grip/textured	✘ 9/20/30 mm
VENTI BOOST	unglazed matte	✘ 9 mm

Medium commercial and residential. Commerciale medio e residenziale.		M L
ARKSHADE	polished *	✘ 9 mm
BLAZE	matte/polished *	✘ 6/9 mm
BOOST	matte	✘ 6 mm
BOOST PRO	matte	✘ 6 mm
DWELL	polished *	✘ 9 mm
GREENCOLORS	matte/grip	✘ 7,3 mm
LIMS	matte	✘ 6 mm
MARK	polished *	✘ 9 mm
MARVEL	matte/polished *	✘ 6/9 mm
MARVEL EDGE	polished *	✘ 6/9 mm
MARVEL DREAM	matte/polished *	✘ 6/9 mm
MARVEL PRO	matte/polished *	✘ 6/9 mm
MARVEL SHINE	matte/polished/silk *	✘ 6/9 mm
MARVEL STONE	matte/polished *	✘ 6/9 mm
PRISM	matte/silk *	✘ 6/9 mm
RAW	matte	✘ 6 mm
VENTI BOOST	glazed matte	✘ 9 mm

* Polished and silk finishes are recommended for low-stress residential or commercial floors where anti-slip performance is not required. The surface's shine and superior ease of cleaning are the result of in-depth studies and extensive technical research aimed at ensuring its durability over time. If the product is in direct contact with the outside, use moisture and dirt absorption devices to prevent scratches. / Le finiture lappata e silk sono indicate per pavimenti residenziali o commerciali poco sollecitati, laddove non siano richieste prestazioni antiscivolo. La lucentezza e l'elevata facilità di pulizia della superficie sono frutto di studi approfonditi e accurate ricerche tecniche volte a garantirne la persistenza nel tempo. Se il prodotto è a diretto contatto con l'esterno, prevedere dei dispositivi di assorbimento dell'umidità e dello sporco per prevenire la formazione di graffi. / Les finitions rodée et soyeuse conviennent aux sols résidentiels ou commerciaux à faibles contraintes, où la performance antidérapante n'est pas requise. La brillance et la grande facilité de nettoyage de la surface sont le résultat d'études approfondies et de recherches techniques précises visant à assurer sa persistance dans le temps. Si le produit est en contact direct avec l'extérieur, prévoyez des dispositifs d'absorption de l'humidité et de la saleté pour éviter la formation de rayures. / Die Oberflächenversionen Geläpft und Silk eignen sich für Bodenbeläge in Wohnbereichen bzw. in gering beanspruchten Gewerberäumen, wenn keine Rutschfestigkeit erforderlich ist. Der Glanz und die einfache Reinigung der Oberfläche sind das Resultat eingehender technischer Studien, mit denen die langfristige Beständigkeit sichergestellt wurde. Kommt das Produkt direkt mit der externen Umgebung in Kontakt, so sind Feuchtigkeit und Schmutz mit geeigneten Mitteln aufzunehmen, um Kratzer zu vermeiden. / Los acabados lapeados y silk son adecuados para pavimentos residenciales y comerciales con poco tráfico, donde no se requiere un efecto antideslizante. El brillo y la gran facilidad de limpieza de la superficie son el resultado de profundos estudios e investigaciones técnicas precisas para asegurar su persistencia en el tiempo. Si el producto está en contacto directo con el exterior, proporcionar dispositivos de absorción de humedad y suciedad para evitar arañazos. / Лаппатированная поверхность и поверхность Silk рекомендованы для полов жилых и коммерческих помещений с невысокой интенсивностью эксплуатации, в которых от покрытий не требуется характеристик сопротивления скольжению. Блеск и легкая очищаемость являются результатом глубоких исследований, направленных на создание долговечного материала. Если плитка находится в непосредственном контакте с наружной средой, необходимо предусмотреть устройства поглощения влаги и грязи во избежание образования царапин.

Porcelain tiles for outdoors / Gres porcellanato per esterni

PORCELAIN TILES / GRES PORCELLANATO

Grès cérame / Feinsteinzeug

Gres porcelánico / Керамогранит

INTENDED USES FOR OUTDOORS / DESTINAZIONE D'USO PER ESTERNI

Destination à usage extérieur / zweckbestimmungen für Aussenbereiche / uso previsto para exteriores / назначение для наружных пространств

INDUSTRIAL AND/OR COMMERCIAL AREAS FOR VEHICLES

Squares, public car parks, filling stations, paving for forklift trucks, pallet jacks, trailer trucks, buses, industrial platforms, etc.

INSTALLATION METHOD

Laying with adhesives using the "double buttering" method.

PRODUCT PORCELAIN TILES ⁽¹⁾

Porcelain tile with a thickness greater than or equal to 20 mm with anti-slip finish ⁽¹⁾.

AREE INDUSTRIALI E/O COMMERCIALI CARRABILI

Piazze, parcheggi pubblici, stazioni di rifornimento, pavimentazioni con transito di carrelli elevatori, transpallet, autoarticolati, autobus, piattaforme industriali, ecc...

TIPO DI POSA

Posa con adesivi con il metodo della "doppia spalmatura".

PRODOTTO GRES PORCELLANATO ⁽¹⁾

Gres porcellanato a spessore superiore o uguale a 20mm con finitura anti-scivolo ⁽¹⁾.

ZONES INDUSTRIELLES ET/OU ZONES COMMERCIALES AVEC PASSAGE DE VÉHICULES

Places, parkings publics, stations-services, sols avec passage de chariots élévateurs, transpalettes, véhicules articulés, autobus, plateformes industrielles, etc...

TYPE DE POSE

Pose à l'aide de colles par la méthode du "double encollage".

PRODUIT GRÈS CÉRAME ⁽¹⁾

Grès cérame d'épaisseur supérieure ou égale à 20 mm à finition anti-glisse⁽¹⁾.

BEFAHRBARE INDUSTRIE- UND/ODER GEWERBEFLÄCHEN

Plätze, öffentliche Parkplätze, Tankstellen, von Gabelstaplern, Handgabelhubwagen, Sattelschleppern, Bussen befahrene Böden, Industriplattformen etc.

VERLEGESYSTEM

Verlegung mit beidseitig aufgebrachtem Kleber (Buttering-Floating-Verfahren)

PRODUKT FEINSTEINZEUG ⁽¹⁾

Feinsteinzeug mit Stärke gleich oder über 20 mm und rutschfester Oberfläche⁽¹⁾.

ÁREAS INDUSTRIALES Y/O COMERCIALES TRAFICABLES

Centros comerciales, aeropuertos, lugares de culto, colegios, museos, plazas, hospitales, hoteles - hall de entrada, metros, estaciones de trenes, etc. ...

TIPO DE COLOCACIÓN

Colocación con materiales de agarre según el método de "doble encolado".

PRODUCTO GRES PORCELÁNICO ⁽¹⁾

Gres porcelánico de grosor mayor o igual a 20mm con acabado antideslizante⁽¹⁾.

ПРОМЫШЛЕННЫЕ И (ИЛИ) КОММЕРЧЕСКИЕ ПРОЕЗЖИЕ УЧАСТКИ

Площади, общественные парковки, заправочные станции, покрытия для проезда погрузчиков, гидравлических тележек, фур, автобусов, промышленные платформы и т.д.

ТИП УКЛАДКИ

Клеевая укладка с нанесением клея на монтажную сторону плитки и на облицовываемое основание

ИЗДЕЛИЕ КЕРАМОГРАНИТ ⁽¹⁾

Керамогранит толщиной 20 мм или больше с противоскользящей поверхностью⁽¹⁾.

RESIDENTIAL AREAS FOR VEHICLES

Outdoor courtyards, private homes, apartment complex parking lots (garages), etc. Pavements used only by cars.

INSTALLATION METHOD

Laying with adhesives using the "double buttering" method.

PRODUCT PORCELAIN TILES ⁽¹⁾

Porcelain tiles with anti-slip finish ⁽¹⁾.

AREE RESIDENZIALI CARRABILI

Cortili esterni abitazioni private, parcheggi condominiali (garage interni), ecc... Pavimentazioni a transito esclusivo di autovetture.

TIPO DI POSA

Posa con adesivi con il metodo della "doppia spalmatura".

PRODOTTO GRES PORCELLANATO ⁽¹⁾

Gres porcellanato con finitura anti-scivolo ⁽¹⁾.

ZONES RÉSIDENTIELLES AVEC PASSAGE DE VÉHICULES

Cours externes d'habitations individuelles, parkings d'immeuble (garages intérieurs), etc... Sols pour passage exclusivement de voitures.

TYPE DE POSE

Pose à l'aide de colles par la méthode du "double encollage".

PRODUIT GRÈS CÉRAME ⁽¹⁾

Grès cérame à finition anti-glisse ⁽¹⁾.

BEFAHRBARE BEREICHE IM WOHNUNGSBAU

Außenhöfe und Parkplätze von Wohnhäusern, (Tiefgaragen) etc.

Ausschließlich von Pkws befahrene Bodenbeläge.

VERLEGESYSTEM

Verlegung mit beidseitig aufgebrachtem Kleber (Buttering-Floating-Verfahren)

PRODUKT FEINSTEINZEUG ⁽¹⁾

Feinsteinzeug mit rutschfester Oberfläche⁽¹⁾.

ÁREAS RESIDENCIALES TRAFICABLES

Patios exteriores de viviendas particulares, aparcamientos de bloques multifamiliares (garajes interiores), etc... Pavimentos de tráfico exclusivo de automóviles.

TIPO DE COLOCACIÓN

Colocación con materiales de agarre según el método de "doble encolado".

PRODUCTO GRES PORCELÁNICO ⁽¹⁾

Gres porcelánico con acabado antideslizante ⁽¹⁾.

ПРОЕЗЖИЕ УЧАСТКИ ПРИ ЖИЛЫХ ОБЪЕКТАХ

Дворы частных домов, парковки многоквартирных домов (внутренние гаражи) и т.п. Покрытия, предназначенные для проезда только легковых автомобилей.

ТИП УКЛАДКИ

Клеевая укладка с нанесением клея на монтажную сторону плитки и на облицовываемое основание

ИЗДЕЛИЕ КЕРАМОГРАНИТ ⁽¹⁾

Керамогранит с противоскользящей поверхностью⁽¹⁾.

AREAS FOR PEDESTRIANS ONLY

Patios, gardens and walkways, terraces, balconies, urban pedestrian areas, etc.

INSTALLATION METHOD

"Dry" laying (on grass, sand, and gravel) and raised installation

PRODUCT PORCELAIN TILES ⁽¹⁾

Porcelain tile with a thickness greater than or equal to 20 mm with anti-slip finish ⁽¹⁾.

-

INSTALLATION METHOD

Laying with adhesives using the "double buttering" method.

PRODUCT PORCELAIN TILES ⁽¹⁾

Porcelain tiles with anti-slip finish ⁽¹⁾.

AREE SOLO PEDONABILI

Patii, giardini e camminamenti, terrazze, balconi, aree urbane pedonali, ecc...

TIPO DI POSA

Posa "a secco" (su erba, sabbia e ghiaia) e posa sopraelevata.

PRODOTTO GRES PORCELLANATO ⁽¹⁾

Gres porcellanato a spessore superiore o uguale a 20mm con finitura anti-scivolo ⁽¹⁾.

-

TIPO DI POSA

Posa con adesivi con il metodo della "doppia spalmatura".

PRODOTTO GRES PORCELLANATO ⁽¹⁾

Gres porcellanato con finitura anti-scivolo ⁽¹⁾.

ZONES UNIQUEMENT PIÉTONNES

Patios, jardins et allées, terrasses, balcons, zones urbaines piétonnes, etc...

TYPE DE POSE

Pose "à sec" (sur herbe, sable ou graviers) et pose surélevée.

PRODUIT GRÈS CÉRAME ⁽¹⁾

Grès cérame d'épaisseur supérieure ou égale à 20 mm à finition anti-glisse⁽¹⁾.

-

TYPE DE POSE

Pose à l'aide de colles par la méthode du "double encollage".

PRODUIT GRÈS CÉRAME ⁽¹⁾

Grès cérame à finition anti-glisse ⁽¹⁾.

REINE FUSSGÄNGERBEREICHE

Innenhöfe, Gärten und Gehwege, Terrassen, Balkone, städtische Fußgängerzonen etc.

VERLEGESYSTEM

„Trockenverlegung“ (auf Gras, Sand und Kies) und erhöhte Verlegung.

PRODUKT FEINSTEINZEUG ⁽¹⁾

Feinsteinzeug mit Stärke gleich oder über 20 mm und rutschfester Oberfläche⁽¹⁾.

-

VERLEGESYSTEM

Verlegung mit beidseitig aufgebrachtem Kleber (Buttering-Floating-Verfahren)

PRODUKT FEINSTEINZEUG ⁽¹⁾

Feinsteinzeug mit rutschfester Oberfläche⁽¹⁾.

PEŠEHODNÉ UČASTKI

Патио, сады, садовые дорожки, террасы, балконы, городские пешеходные площади и т.п.

ТИП УКЛАДКИ

Сухая бесклеевая укладка (на траву, песок, гравий) и укладка на опоры

ИЗДЕЛИЕ КЕРАМОГРАНИТ ⁽¹⁾

Керамогранит толщиной 20 мм или больше с противоскользящей поверхностью ⁽¹⁾.

-

ТИП УКЛАДКИ

Клеевая укладка с нанесением клея на монтажную сторону плитки и на облицовываемое основание.

ИЗДЕЛИЕ КЕРАМОГРАНИТ ⁽¹⁾

Керамогранит с противоскользящей поверхностью⁽¹⁾.

POOL EDGES

INSTALLATION METHOD

Laying with adhesives using the "double buttering" method.

PRODUCT Porcelain tiles ⁽¹⁾

Porcelain tiles with anti-slip finish ⁽¹⁾.

BORDI PISCINA

TIPO DI POSA

Posa con adesivi con il metodo della "doppia spalmatura".

PRODOTTO GRES PORCELLANATO ⁽¹⁾

Gres porcellanato con finitura anti-scivolo ⁽¹⁾.

-

GRÈS CÉRAME à finition anti-glisse ⁽¹⁾.

SCHWIMMBECKENRÄNDER

VERLEGESYSTEM

Verlegung mit beidseitig aufgebrachtem Kleber (Buttering-Floating-Verfahren)

PRODUKT FEINSTEINZEUG ⁽¹⁾

Feinsteinzeug mit rutschfester Oberfläche⁽¹⁾.

-

BORDES PISCINA

TIPO DE COLOCACIÓN

Colocación con materiales de agarre según el método de "doble encolado".

PRODUCTO GRES PORCELÁNICO ⁽¹⁾

Gres porcelánico con acabado antideslizante ⁽¹⁾.

-

КРАЯ БАССЕЙНОВ

ТИП УКЛАДКИ

Клеевая укладка с нанесением клея на монтажную сторону плитки и на облицовываемое основание

ИЗДЕЛИЕ КЕРАМОГРАНИТ ⁽¹⁾

Керамогранит с противоскользящей поверхностью⁽¹⁾.

Porcelain tiles for outdoors. Gres porcellanato per esterni.	
---	---

ARBOR	grip	± 9 mm
ARKSHADE	grip	± 9 mm
AIX	grip/textured	± 9/20 mm
AXI	textured	± 9,5/20 mm
BLAZE	grip/textured	± 9/20 mm
BOOST	grip/textured	± 9/20 mm
BOOST PRO	grip/textured	± 9/20 mm
BRAVE	grip/textured	± 9/20 mm
DOLMEN PRO	grip/textured	± 9/20 mm
DWELL	textured	± 20 mm
ETIC PRO	grip/textured	± 9/20 mm
EXENCE	grip/textured	± 9/20 mm
GRANIGLIATI	textured	± 7,6/8,6/12 mm
GROUNDTRACK	matte	± 9 mm
KLIF	grip/textured	± 9/20 mm
KONE	grip/textured	± 9/20 mm
LIMS	grip/textured	± 9/20 mm
MARVEL PRO	textured	± 9 mm
MARVEL STONE	textured	± 9/20 mm
NASH	grip	± 9 mm
NORDE	grip/roccia/textured	± 9/20 mm
PRISM	grip/textured	± 9/20 mm
RAW	grip/textured	± 9/20 mm
SEASTONE	textured	± 20 mm
SUNROCK	textured	± 20 mm
TRUST	grip/textured	± 9/20/30 mm

IMPORTANT NOTES | WARNINGS - NOTE IMPORTANTI | AVVERTENZE
NOTES IMPORTANTES | AVERTISSEMENTS/ WICHTIGE HINWEISE | ZUR BEACHTUNG
NOTAS IMPORTANTES | ADVERTENCIAS / ВАЖНЫЕ ПРИМЕЧАНИЯ | ПРЕДУПРЕЖДЕНИЯ

⁽¹⁾ **For the properties of slip resistance required in the aforementioned uses it is always necessary to comply with the local laws, regulations and uses, referring to the technical sheets of the selected products.** Per le proprietà di resistenza allo scivolamento richieste nelle destinazioni d'uso sopra itate occorre sempre attenersi alle normative, leggi ed usi locali facendo riferimento alle schede tecniche dei prodotti selezionati. / Pour les propriétés de résistance à la glissade exigées par les destinations d'usage susmentionnées, il faut toujours respecter les normes, lois et réglementations locales en se référant aux fiches techniques des produits sélectionnés. / Für die von den obigen Zweckbestimmungen verlangte Rutschfestigkeit sind stets die örtlich geltenden Vorschriften, Gesetze und Gebräuche zu beachten. Siehe hierzu die technischen Datenblätter der gewählten Produkte. / Para las propiedades de resistencia al deslizamiento requeridas según los usos previstos antes indicados, es taxativo atenerse a las normativas, leyes y usos locales siempre consultando las fichas técnicas de los productos seleccionados. / Характеристики сопротивления скольжению при использовании плиток для вышеописанных назначений выбирают согласно местным законам, стандартам и правилам по листу технических характеристик выбранных изделий.

⁽²⁾ **If a product with a polished finish is in direct contact with the outdoors, moisture and dirt absorption devices must be used to prevent scratching.** Se il prodotto a finitura lappata è a diretto contatto con l'esterno, occorre prevedere dei dispositivi di assorbimento dell'umidità e della sporizia per prevenire la formazione di graffi. / Si un produit à finition polie est au contact direct avec l'extérieur, il faut prévoir des dispositifs d'absorption de l'humidité et des salissures, ceci afin de prévenir la formation de rayures. / Ist ein Produkt mit geläppter Oberfläche direkt von außen zugänglich, so sind Eingangsmatten zur Aufnahme von Feuchtigkeit und Schmutz erforderlich, um Kratzer zu vermeiden. / El acabado Lapeado pulido está indicado para pisos residenciales o comerciales poco esforzados, donde no se requiera un rendimiento antideslizante, también es ideal para revestimientos. Si el producto está en contacto directo con el exterior, es necesario utilizar los dispositivos de absorción de la humedad y de la suciedad para evitar que se raye. / Если лаппатированная плитка находится в непосредственном контакте с наружной средой, следует предусмотреть подходящие средства поглощения влаги и грязи во избежание образования царапин.

⁽³⁾ **These are general instructions: it is always necessary to check the resistance of the tiling with respect to the maximum expected loads.** Queste sono indicazioni di carattere generale: occorre sempre verificare la resistenza della piastrellatura rispetto ai carichi massimi di progetto. / Ces indications sont de caractère général : il faut toujours vérifier la résistance des carreaux par rapport aux charges maximales prévues dans le projet. / Dies sind allgemeine Hinweise: In jedem Fall ist die Beständigkeit des Fliesenbelags gegen die maximal zu erwartenden Lasten stets zu prüfen. / Estas son indicaciones de carácter general: siempre es necesario verificar la resistencia del embaldosado respecto a las cargas máximas del proyecto. / Данные указания являются указаниями общего характера; рекомендуется всегда проверять стойкость плиточного покрытия с учетом максимальных расчетных нагрузок.

		SAFETY CHARACTERISTICS CARATTERISTICHE DI SICUREZZA (*)							
Serie / Series Série / Serie Серия / Серия	Superficie / Surface Surface / Oberfläche Superficie / Поверхность	Shod Ramp Test Metodo della rampa "calzato" (DIN 51130) *				Barefoot Ramp Test Metodo della rampa a piedi nudi (DIN 51097) *			Pendulum Friction Test Metodo del pendolo (BS 7976) *
		R9	R10	R11	R12	A	A+B	A+B+C	≥ 36 Dry ≥ 36 Wet
Aix	Matte Matt		x				x	x	
	Grip Grip			x			x	x	
	Textured Strutturato			x			x	x	
Arbor	Matte Matt		x				x	x	
	Matte Matt 7,5x60		x			x		(●)	
	Matte Matt 30x240		x			x		(●)	
	Grip Grip			x			x	x	
Arkshade	Matte Matt		x				x	x	
	Grip Grip			x			x	x	
Axi	Matte Matt		x				x	x	
	Textured Strutturato			x			x	x	
Blaze	Matte Matt	x				x		(●)	
	Grip Grip			x			x	x	
Boost	Matte Matt		x				x	x	
	Matte Matt 6 mm	x				x		(●)	
	Grip Grip			x			x	x	
Boost Pro	Matte Matt		x				x	x	
	Matte Matt 6 mm	x				x		(●)	
	Grip Grip			x			x	x	
Brave	Matte Matt		x				*	*	
	Grip Grip			x			*	*	
	Matte Matt		x				x	x	
Dolmen Pro	Grip Grip			x			x	x	
	Textured Strutturato			x			x	x	
Dwell	Matte Matt	x				*		*	
Etic	Matte Matt	x				*		*	
Etic PRO	Matte Matt	x				*		*	
	Grip Grip			x			*	*	
Exence	Matte Matt		x				x	x	
	Grip Grip			x			x	x	
Granigliati	Matte Matt	x 30x30 cm	x 20x20 cm			x 30x30 cm	x 20x20 cm	x	
	Textured Strutturato			x		x 30x30 cm	x 20x20 cm	x	
	Anti-slip type P Antislip tipo P							x	
Greencolors	Grip Grip		x				x	x	
Heartwood	Matte Matt 9,5 mm	x				x		(●)	
	Matte Matt 9 mm		x			x		x	
Klif	Matte Matt		x				x	x	
	Grip Grip			x			x	x	
Kone	Matte Matt		*			*		*	
	Grip Grip			*		*		*	
Lims	Matte Matt		x				x	(●)	
	Matte Matt 6 mm	x				x		(●)	
	Grip Grip			x			x	x	
Mark	Matte Matt		x			x		x	
	Matte Matt 9 mm		x				x	(●)	
Marvel Dream	Matte Matt 6 mm	x				x		(●)	
	Matte Matt	x				x		(●)	
Marvel Edge	Matte Matt	x				x		x	
Marvel Gems	Matte Matt		x			x		x	
Marvel Stone	Matte Matt	x				x		(●)	
	Textured Strutturato			x			x	x	
Marvel	Matte Matt	x				x		x	
	Matte Matt 6 mm	x				x		(●●)	
	Matte Matt	x				x		(●)	
Marvel Pro	Matte Matt 6 mm	x				x		(●)	
	Textured Strutturato			x			x	x	
Marvel Shine	Matte Matt 60x60	x				x		(●)	
	Matte Matt		x			x		x	
Mek	Matte Matt		x			x		x	
	Matte Matt		x			x		x	
Nash	Matte Matt 7,5x60		x			x		(●)	
	Grip Grip			x			x	x	
NID	Matte Matt		x			x		x	
	Matte Matt		x			x		x	
Norde	Grip Grip			x			x	x	
	Roccia Roccia			x			x	x	
Prism	Matte Matt		x				x	(●)	
	Matte Matt 6 mm	x				x		(●)	
	Grip Grip			x			x	x	
Raw	Matte Matt		x				x	x	
	Matte Matt 6 mm	x				x		(●)	
	Grip Grip			x			x	x	
Seastone	Matte Matt	x				x		x	
Trust	Matte Matt		x				x	x	
	Grip Grip			x			x	x	
Venti Boost	Matte Matt		x			x		x	

Outdoor paving ∇ 20mm

		SAFETY CHARACTERISTICS CARATTERISTICHE DI SICUREZZA (*)								
Class P1	Class P2	Class P3	Class P4	Pendulum Friction Test Metodo del pendolo (AS 4586)			Coefficient of friction COF Coefficiente di attrito COF (B.C.R.A)	Dynamic coefficient of friction (DCOF) Coefficiente di attrito dinamico DCOF (ANSI A137.1)	Superficie / Surface Surface / Oberfläche Superficie / Поверхность	Serie / Series Série / Serie Серия / Серия
				Class C1	Class C2	Class C3				
							>0,40 Asciutto >0,40 Bagnato	>0,42 Wet	Matte Matt	Aix
		x					x	x	Grip Grip	
			x				x	x	Textured Strutturato	
							x	x	Matte Matt	Arbor
	(●●)					(●●●)	x	x	Matte Matt 7,5x60	
	(●●)						x	x	Matte Matt 30x240	
			x				x	x	Grip Grip	
	(●●)						x	x	Matte Matt	Arkshade
		x	x				x	x	Grip Grip	
				x			x	x	Matte Matt	Axi
				x			x	x	Textured Strutturato	
		x					x	x	Matte Matt	Blaze
	(●●)					(●●●)	x	x	Matte Matt 6 mm	
			x				x	x	Grip Grip	
	(●●)						x	x	Matte Matt	Boost
		x					x	x	Matte Matt 6 mm	
	(●●)						x	x	Grip Grip	
			x				x	x	Matte Matt	Boost Pro
	(●●)					(●●●)	x	x	Matte Matt 6 mm	
			x				x	x	Grip Grip	
	(●●)						x	x	Matte Matt	Brave
			x				x	x	Grip Grip	
			x				x	x	Matte Matt	Dolmen Pro
				x			x	x	Grip Grip	
	(●●)						x	x	Textured Strutturato	
				x			x	x	Matte Matt	Dwell
	(●●)						x	x	Matte Matt	Etic
	(●●)						x	x	Matte Matt	Etic PRO
			x				x	x	Grip Grip	
				x			x	x	Matte Matt	Exence
				x			x	x	Grip Grip	
	(●●)	x 20x20 cm	x 30x30 cm			x 30x30 cm	x 20x20 cm	x	Matte Matt	Granigliati
		x 30x30 cm	x 20x20 cm			x 30x30 cm	x 30x30 cm	x	Textured Strutturato	
				x			x	x	Anti-slip type P Antislip tipo P	
				x			x	x	Grip Grip	Greencolors
	(●●)					(●●●)	x	x	Matte Matt 9,5 mm	Heartwood
		x					x	x	Matte Matt 9 mm	
			x				x	x	Matte Matt	Klif
	(●●)						x	x	Grip Grip	
		x					x	x	Matte Matt	Kone
			x				x	x	Grip Grip	
	(●●)					(●●●)	x	x	Matte Matt	Lims
				x			x	x	Matte Matt 6 mm	
	(●●)						x	x	Grip Grip	
		x					x	x	Matte Matt	Mark
	(●●)						x	x	Matte Matt 9 mm	
	(●●)					(●●●)	x	x	Matte Matt 6 mm	Marvel Dream
	(●●)					(●●●)	x	x	Matte Matt 9,5 mm	
	(●●)						x	x	Matte Matt	Marvel Edge
	(●●)						x	x	Matte Matt	Marvel Gems
	(●●)					(●●●)	x	x	Matte Matt	Marvel Stone
			x				x	x	Textured Strutturato	
	(●●)						x	x	Matte Matt	Marvel
	(●●)					(●●●)	x	x	Matte Matt 6 mm	
	(●●)						x	x	Matte Matt	Marvel Pro
	(●●)					(●●●)	x	x	Textured Strutturato	
	(●●)	x					x	x	Matte Matt 60x60	Marvel Shine
	(●●)					(●●●)	x	x	Matte Matt	
	(●●)					(●●●)	x	x	Matte Matt	Mek
	(●●)					(●●●)	x	x	Matte Matt	
	(●●)					(●●●)	x	x	Matte Matt 7,5x60	Nash
			x				x	x	Grip Grip	
				x			x	x	Matte Matt	NID
				x			x	x	Matte Matt	
				x			x	x	Grip Grip	Norde
				x			x	x	Roccia Roccia	
	(●●)					(●●●)	x	x	Matte Matt	Prism
				x			x	x	Matte Matt 6 mm	
				x			x	x	Grip Grip	
				x			x	x	Matte Matt	Raw
	(●●)					(●●●)	x	x	Matte Matt 6 mm	
				x			x	x	Grip Grip	
	(●●)						x	x	Matte Matt	Seastone
	(●●)						x	x	Matte Matt	
				x			x	x	Grip Grip	Trust
				x			x	x	Matte Matt	Venti Boost

Outdoor paving ∇ 20mm

* Determination of slip resistance of pedestrian surfaces; it does not cover sports surfaces and road surfaces for vehicles (skid resistance).
 Determinazione della resistenza allo scivolamento delle superfici pedonabili; non si applica alle pavimentazioni sportive ed alle pavimentazioni stradali veicolari.
 Determination of the resistance au glissement des surfaces piétonnes ; elle ne s'applique pas aux sols sportifs, ni aux revêtements routiers.
 Bestimmung der Rutschfestigkeit von begehbaren Oberflächen; gilt nicht für Sportböden und Straßenböden.
 Determinación de la resistencia al deslizamiento de las superficies peatonales; no se aplica a las pavimentaciones deportivas y calzadas.
 Установление сопротивления скольжению напольных покрытий; не применяется к спортивным напольным покрытиям и дорожным покрытиям, предназначенным для проезда транспорта.

Classification NON-SLIP / NON-SLIP Klassifizierung / Clasificación NON-SLIP / сопротивление скольжению

(●). PTV ≥ 36 Wet on demand / su richiesta (●●). P3 on demand / su richiesta (●●●). C2 on demand / su richiesta
 (●) Le prestazioni anti-slip vengono garantite al momento della consegna del prodotto. - Anti-slip performance is guaranteed at the time of delivery of the product.

Wall Tiles

Complies with	EN 14411 (ISO 13006)	Appendix	L	Group	BIII
Conforme alla norma	EN 14411 (ISO 13006)	Appendice	L	Gruppo	BIII
Conforme à la norme	EN 14411 (ISO 13006)	Appendice	L	Groupe	BIII
Entsprechend	EN 14411 (ISO 13006)	Anhang	L	Gruppe	BIII
Conforme a la norma	EN 14411 (ISO 13006)	Apéndice	L	Grupo	BIII
Соответствует норме	EN 14411 (ISO 13006)	Приложение	L	Группа	BIII

atlas concorde



Technical specification symbols / Simbologia caratteristiche tecniche

Dimensions Dimensioni Dimensions Maße Tamaño Размер	ISO 10545-2		Length and width Lunghezza e larghezza Longuer et largeur / Länge und breite / Longitud y anchura / Размеры сторон (*)
			Thickness Spessore Épaisseur / Stärke / Grosor / Толщина (**)
			Straightness of sides Rettilinearità degli spigoli Rectitude des arêtes / Kantengeradheit / Rectilineidad de las aristas / Кривизна сторон (***)
			Rectangularity Ortogonalità Orthogonalité / Rechtwinkligkeit / Ortogonalidad / Косоугольность (****)
Physical properties Proprietà fisiche Propriétés physiques Physikalische Eigenschaften Propiedades físicas Физические характеристики	ISO 10545-3		SURFACE FLATNESS PLANARITÀ Planimetrie / Ebenflächigkeit / Planaridad / Кривизна лицевой поверхности c.c. e.c. ws.
			Water absorption Massa d'acqua assorbita Masse d'eau absorbée / Aufgenommene Wassermasse / Peso de agua absorbida / Водопоглощение
			BREAKING STRENGTH SFORZO DI ROTTURA Force de rupture / Bruchlast / Esfuerzo de ruptura / Усилие на излом
			Modulus of rupture Resistenza alla flessione Résistance à la flexion / Biegefestigkeit / Resistencia a la flexión / Устойчивость к изгибу
			Coefficient of thermal linear EXPANSION Coefficiente di DILATAZIONE TERMICA lineare Coefficient de dilatation thermique linéique / Lineare thermische Dehnung Coeficiente de dilatación térmica lineal / Коэффициент линейного расширения
			THERMAL SHOCK resistance Resistenza agli SBALZI TERMICI Résistance aux écarts de température / Temperaturwechs elbeständigkeit Resistencia a los cambios de temperatura / Устойчивость к перепаду температур
			Moisture expansion (in mm/m) Dilatazione all'umidità (in mm/m) Dilatation à l'humidité (en mm/m) / Feuchtigkeitsausdehnung (in mm/m) Dilatación por la humedad (en mm/m) / Расширение под воздействием влаги (в мм/м)
			Crazing resistance Resistenza al cavillo Résistance aux craquelures / Haariß-Beständigkeit / Resistencia a grietas / Устойчивость эмали к кракелюру (старению)
			Bond strength/adhesion for improved cementitious adhesives Adesione a trazione con adesivi cementizi migliorati Adhérence par traction avec des ciments-colle améliorés / Scherfestigkeit mit verbesserten zementhaltigen Klebern Adherencia a tracción con adhesivos cementosos mejorados Прочность на растяжение при приклеивании улучшенными цементными клеями
			Reaction to fire Reazione al fuoco Réaction au feu / Brandverhalten / Reacción al fuego / Огнестойкость
		Chemical properties Proprietà chimiche Propriétés chimiques Chemische Eigenschaften Propiedades químicas Химические характеристики	ISO 10545-13
	Resistance to low concentrations of ACIDS and ALKALIS Resistenza a basse concentrazioni di ACIDI e ALCALI Résistance aux acides et aux alcalis à basse concentration / Beständigkeit gegen niedrigkonzentrierte Säuren und Laugen Resistencia a los ácidos y bases de baja concentración / Сопротивление кислотам и щелочам низкой концентрации		
	Resistance to high concentrations of ACIDS and ALKALIS Resistenza ad alte concentrazioni di ACIDI e ALCALI Résistance aux acides et aux alcalis à haute concentration / Beständigkeit gegen hochkonzentrierte Säuren und Laugen Resistencia a los ácidos y bases de alta concentración / Сопротивление кислотам и щелочам низкой концентрации		
	Resistance to STAINING Resistenza alle MACCHIE Résistance aux taches / Widerstand gegen fleckenbildung / Resistencia a las manchas / Устойчивость эмали к загрязнению		
ISO 10545-15		Release of dangerous substances: Cadmium (in mg/dm²) and Lead (in mg/dm²) Rilascio di sostanze pericolose: Cadmio (in mg/dm²) e Piombo (in mg/dm²) Emission de substances dangereuses: Cadmium (mg/dm²) et Plomb (mg/dm²) Emission von gefährlichen Stoffen: Cadmium (mg/dm²) und Blei (mg/dm²) Emisión de sustancias peligrosas: Cadmio (mg/dm²) y Plomo (mg/dm²) Выделение вредных веществ: кадмия (в мг/дм²) и свинца (в мг/дм²)	

(*) The permissible deviation, in % or mm, of the average size for each tile (2 or 4 sides) from work size (WS).
Deviación ammissible, in % oppure mm, della dimensione media di ogni piastrella (2 oppure 4 lati) dalla dimensione di fabbricazione (WS).

(**) The permissible deviation, in % or mm, of the average thickness for each tile from the work size thickness (WS).
Deviación ammissible, in % oppure mm, dello spessore medio di ogni piastrella dallo spessore riportato nella dimensione di fabbricazione (WS).

(***) The maximum permissible deviation from straightness, in % or mm, related to the corresponding work sizes (WS).
Deviación massima ammissible di rettilinearità, in % oppure mm, in rapporto alle dimensioni di fabbricazione (WS) corrispondenti.

(****) The maximum permissible deviation from rectangularity, in % or mm, related to the corresponding work sizes (WS).
Deviación massima ammissible di ortogonalità, in % oppure mm, in rapporto alle dimensioni di fabbricazione (WS) corrispondenti.

c.c. The maximum permissible deviation from centre curvature, in % or mm, related to diagonal calculated from the work sizes (WS).
Deviación massima ammissible della curvatura del centro, in % oppure mm, in rapporto alla diagonale calcolata secondo le dimensioni di fabbricazione (WS).

e.c. The maximum permissible deviation from edge curvature, in % or mm, related to the corresponding work sizes (WS).
Deviación massima ammissible della curvatura dello spigolo, in % oppure mm, in rapporto alle dimensioni di fabbricazione (WS) corrispondenti.

w. The maximum permissible deviation from warpage, in % or mm, related to diagonal calculated from the work sizes (WS).
Deviación massima ammissible dello svergolamento, in % oppure mm, in rapporto alla diagonale calcolata secondo le dimensioni di fabbricazione (WS).

LAYING SUGGESTIONS

Before starting the installation process, make sure the laying surface is well cured, flat and completely clean.

1. CHOICE OF ADHESIVE

The use of an appropriate adhesive is essential for a successful installation. For the installation of ceramic tiles, you should follow the laying instructions provided by leading adhesives manufacturers.

You should choose the most suitable adhesive on the basis of the following factors:

- laying surface
- type and size of tile
- use of tiled surface (floor/wall; indoor/outdoor)
- weather conditions at the time of laying
- waiting time before the ceramic surface can be used

USE	TYPE OF TILE Type	SIZE (cm)	RECOMMENDED ADHESIVES - European Standards EN 12004	
			Normal Set	Rapid set
INDOOR FLOORS				
Cementitious screeds Existing cement floors (cement concrete, bush-hammered) Anhydrite screeds (following application of a suitable primer) Heating floors Existing ceramic, terrazzo and natural stone floors Waterproofing in bathrooms	porcelain stoneware tiles	< 30x30 cm	Improved cementitious adhesives with long open time (Class C2E).	Improved cementitious adhesives, slip resistant and deformable (Class C2FT - S1). ●
		≤ 30x30 cm < 60x60 cm	Improved cementitious adhesives resistant to slip and with long open time (Class C2TE).	Improved cementitious adhesives, slip resistant and deformable (Class C2FT - S1). ●
		≥ 60x60 cm	Improved cementitious adhesives with long open time and deformable (Class C2E - S1).	Improved cementitious adhesives, slip resistant and deformable (Class C2FT - S1). ●
INDOOR WALL TILES				
Cementitious plaster or mortar Plaster (plaster or panels, following application of a suitable primer) Painted walls Cast concrete (Following application of primer on gypsum-based joints) Plasterboard Waterproofing in bathrooms and showers Existing ceramic tiles	white body wall tiles porcelain stoneware tiles	any size	Improved cementitious adhesives resistant to slip and with long open time (Class C2TE).	Improved cementitious adhesives, slip resistant and deformable (Class C2FT - S1). ●
		< 30x30 cm	Improved cementitious adhesives resistant to slip and with long open time (Class C2TE).	Improved cementitious adhesives, slip resistant and deformable (Class C2FT - S1). ●
		≤ 30x30 cm < 60x60 cm	Improved cementitious adhesives resistant to slip and with long open time (Class C2TE).	Improved cementitious adhesives, slip resistant and deformable (Class C2FT - S1). ●
		≥ 60x60 cm	Improved cementitious adhesives resistant to slip with long open time and deformable (Class C2TE - S1).	Improved cementitious adhesives, slip resistant and deformable (Class C2FT - S1). ●
OUTDOOR FLOORS				
Cementitious screeds Concrete floor Layers of waterproofing	porcelain stoneware tiles	< 30x30 cm	A Improved cementitious adhesives resistant to slip and with long open time (Class C2TE).	Improved cementitious adhesives, slip resistant and deformable (Class C2FT - S1). ●
		≤ 30x30 cm < 60x60 cm	Improved cementitious adhesives resistant to slip with long open time and deformable (Class C2TE - S1).	Improved cementitious adhesives, slip resistant and deformable (Class C2FT - S1). ●
		≥ 60x60 cm	Improved cementitious adhesives with long open time and highly deformable (Class C2E - S2).	Improved cementitious adhesives with long open time and highly deformable (Class C2FE - S2). ●
OUTDOOR WALLS				
Cementitious plaster Concrete cast in situ or prefabricated	porcelain stoneware tiles	< 30x30 cm	Improved cementitious adhesives resistant to slip with long open time and deformable (Class C2TE - S1).	Improved cementitious adhesives, slip resistant and deformable (Class C2FT - S1). ●
		≥ 30x30 cm < 60x60 cm ●●	Improved cementitious adhesives resistant to slip with long open time and deformable (Class C2TE - S1).	Improved cementitious adhesives, slip resistant and deformable (Class C2FT - S1). ●
		≥ 60x60 cm ●●	Improved cementitious adhesives with long open time and highly deformable (Class C2E - S2).	Improved and highly deformable cementitious adhesives (Class C2F - S2). ●

- For large size tiles laid at a height of more than three metres, certain international regulations specify that tiles should be laid using a mixed system of adhesive and mechanical fixtures chosen in relation to the weight of the tile, height of the tiling and site conditions.
- For tiles with a side measuring more than 30 cm laid at heights of more than three meters, certain international regulations specify the use of an additional mechanical anchor that ensures the retention of the tile in case of accidental detachment, to be chosen in relation to the weight of the tile, the height of the tiling and the site conditions.

2. SPREADING THE ADHESIVES AND LAYING THE TILES: TIPS

When laying tiles with a side longer than 60 cm and in any case for commercial indoor environments or outdoors it is essential to apply the adhesive using double buttering, applying the adhesive in a linear method parallel to the short side. It is essential that the direction of application of the adhesive on the substrate is parallel to the direction of application on the back of the tile, thus ensuring perfect adhesion between the tile and substrate.

To minimize the unevenness of the tiles both on the floor and on the wall it is recommended to use "easy installation systems" with spacers and levelers. Spread the adhesive using a suitably toothed spatula.

3. JOINTS AND GROUTING

The invisible joints, i.e., installation with joints smaller than 2 mm, are not recommended.

For straight courses, the maximum offset between tiles must not exceed 1/3 of the length of the adjacent side.

You should follow the instructions provided by leading grout manufacturers.

USE	RECOMMENDED GROUTS - EUROPEAN STANDARDS EN 13888
Residential interiors	Improved cementitious mortars for joints (Class CG2)
Damp interiors (bathrooms, showers) and outdoors	Improved cementitious mortars for joints with low water absorption (CG2 WA)
Commercial premises	Improved cementitious mortars for joints with high resistance to abrasion (Class CG2 A)
Premises requiring total hygiene and resistance to chemical agents (swimming pools, kitchen work surfaces, food industry, hospitals, supermarkets, etc).	Epoxy mortars (Class RG).

3a. ELIMINATION OF EXCESS GROUT

To correctly and easily eliminate excess grout, follow the instructions given by the grout manufacturer. In general, proceed as follows:

Cementitious grouts

When the grout becomes opaque (normally after 10-20 minutes), clean with a hard cellulose sponge using movements on a diagonal to the joints. It is important to respect the drying time to avoid removing the grout from the joints.

Epoxy grouts

When the mixture is still fresh, wet the surface with plenty of water, emulsifying with a pad like Scotch-Brite®, paying attention not to empty the joints.

The residual grout liquid can be removed with a hard cellulose sponge (to be replaced when excessively soaked with resin).

It is vital to remove epoxy grout rapidly before it starts hardening as it is extremely difficult to remove subsequently. If the epoxy grout has started to harden, try adding 10% alcohol to the washing water.

4. CLEANING AND MAINTENANCE

4a. FINAL SITE CLEANING

After a few days, eliminate residues with a commercial Scotch-Brite® pad, brush or single brush floor cleaner (for large surfaces).

For walls, use a neutral detergent in hot water.

For floors, use a mild acid wash diluted according to the type of surface (smooth or textured). It is important to protect marble or metal inserts previously with adhesive tape.

Rinse with abundant clean water to eliminate all marks or residues from the joints.

If necessary, repeat the acid wash at a higher concentration, unless there are marble or metal inserts. Do not use diluted commercially-available acids.

4b. ROUTINE MAINTENANCE

You are recommended to use ordinary neutral detergent diluted in water.

Avoid using acid or alkaline products, waxes and/or impregnants and metal pads (iron or steel sponges).

In the event of heavy dirt or particularly textured surfaces, use an alkaline detergent and rinse after washing.

For large surfaces, the use of a floor washing machine is recommended.

4c. EXTRAORDINARY MAINTENANCE

In the event of dirt resistant to the ordinary cleaning, use a suitable detergent for the particular kind of dirt.

TYPE OF DIRT (resistant to ordinary maintenance)	DETERGENT/SOLVENT
Coal, lime efflorescence, chalk, metal marks, rust, graphite, emulsion paint	Acid detergents*
Coca cola, coffee, wine, beer, ice cream	Alkaline detergents
Resin, silicon or mechanical oils, candle wax, paint	Solvents
Tire marks, sole marks, suction cup marks	Alkaline detergent in an abrasive paste

* Important: Acid products may corrode marble, granite, natural stone and metal. Avoid using in the presence of decoration or inserts in these materials

The suggestions and advice given above are the result of research, laboratory tests and many years experience.

However, the cleaning characteristics of the materials may vary significantly depending on the laying method, conditions of use, type of surface and environment. Generally speaking, the higher the non-slip characteristics of the tiles, the more difficult they are to clean.

The maintenance and cleaning operative should always test each cleaning method empirically in advance (if possible on a piece of the material not laid)

In the case of particularly heavy use (for example, mechanical workshops or environments with a heavy presence of oily residues and tire marks), incorrect laying or inappropriate cleaning, Atlas Concorde declines all responsibility for the effectiveness of cleaning and maintenance operations.

Atlas Concorde cannot, under no circumstances, be held responsible for events, damage or defects caused by incorrect laying, negligent cleaning and maintenance or the use of materials and adhesives inappropriate for the use.

For more information, refer to the "Installation, Use, Cleaning, and Maintenance Manual".

SUGGERIMENTI PER LA POSA

Prima di iniziare la posa, si raccomanda di assicurarsi che la superficie di appoggio sia sufficientemente stagionata, planare e ben pulita.

1. SCELTA DELL'ADESIVO

L'utilizzo di un adesivo appropriato è di fondamentale importanza per la posa. Si raccomanda di seguire le indicazioni dei migliori produttori di adesivi per la posa di piastrelle ceramiche.

In generale, l'adesivo più adeguato si individua considerando i seguenti fattori:

- tipo di supporto;
- tipologia e formato delle piastrelle;
- destinazione d'uso (pavimento/rivestimento; interno/esterno) del rivestimento ceramico;
- condizioni climatiche all'atto della posa;
- tempi a disposizione per la messa in esercizio del rivestimento ceramico.

DESTINAZIONE D'USO Tipo di supporto	TIPO DI PIASTRELLE Tipologia	FORMATO (cm)	ADESIVI CONSIGLIATI - Normativa Europea EN 12004	
			Presenza normale	Presenza rapida
PAVIMENTI INTERNI				
Massetti cementizi Pavimento in cemento esistenti (Battuto, bocciardato)	grès porcellanato	< 30x30 cm	Adesivi cementizi migliorati e a tempo aperto allungato (classe C2E).	Adesivi cementizi migliorati resistenti allo scivolamento e deformabili (classe C2FT - S1). ●
Massetti in anidrite (Previa applicazione di opportuno primer)		≤ 30x30 cm < 60x60 cm	Adesivi cementizi migliorati, resistenti allo scivolamento e a tempo aperto allungato (classe C2TE).	Adesivi cementizi migliorati resistenti allo scivolamento e deformabili (classe C2FT - S1). ●
Massetti riscaldanti Pavimenti in ceramica, marmette e pietre naturali esistenti Impermeabilizzazione in bagni		≥ 60x60 cm	Adesivi cementizi migliorati, a tempo aperto allungato e deformabili (classe C2E - S1).	Adesivi cementizi migliorati resistenti allo scivolamento e deformabile (classe C2FT - S1). ●
RIVESTIMENTI INTERNI				
Intonaco cementizio o malta Gesso (Intonaci o pannelli previa applicazioni di opportuno primer)	grès porcellanato	tutti formati	Adesivi cementizi migliorati, resistenti allo scivolamento e a tempo aperto allungato (classe C2TE).	Adesivi cementizi migliorati resistenti allo scivolamento e deformabili (classe C2FT - S1). ●
Calcestruzzo di getto Gesso cartonato (Previa applicazione di primer sulle giunture a base gesso)		< 30x30 cm	Adesivi cementizi migliorati, resistenti allo scivolamento e a tempo aperto allungato (classe C2TE).	Adesivi cementizi migliorati resistenti allo scivolamento e deformabili (classe C2FT - S1). ●
Impermeabilizzazioni in bagni e docce Piastrelle ceramiche esistenti		≤ 30x30 cm < 60x60 cm	Adesivi cementizi migliorati, resistenti allo scivolamento e a tempo aperto allungato (classe C2TE).	Adesivi cementizi migliorati resistenti allo scivolamento e deformabili (classe C2FT - S1). ●
		≥ 60x60 cm	Adesivi cementizi migliorati, resistenti allo scivolamento, a tempo aperto allungato e deformabili (classe C2TE - S1).	Adesivi cementizi migliorati resistenti allo scivolamento e deformabili (classe C2FT - S1). ●
PAVIMENTI ESTERNI				
Massetti cementizi Soletta in calcestruzzo Strati di impermeabilizzazione	grès porcellanato	< 30x30 cm	Adesivi cementizi migliorati, resistenti allo scivolamento e a tempo aperto allungato (classe C2TE).	Adesivi cementizi migliorati resistenti allo scivolamento e deformabili (classe C2FT - S1). ●
		≤ 30x30 cm < 60x60 cm	Adesivi cementizi migliorati, resistenti allo scivolamento, a tempo aperto allungato e deformabili (classe C2TE - S1).	Adesivi cementizi migliorati resistenti allo scivolamento e deformabili (classe C2FT - S1). ●
		≥ 60x60 cm	Adesivi cementizi migliorati, a tempo aperto allungato e altamente deformabili (classe C2E - S2).	Adesivi cementizi migliorati a tempo aperto allungato e altamente deformabile (classe C2FE - S2). ●
RIVESTIMENTI ESTERNI				
Intonaco cementizio Calcestruzzo gettato in opera o prefabbricato	grès porcellanato	< 30x30 cm	Adesivi cementizi migliorati, resistenti allo scivolamento, a tempo aperto allungato e deformabili (classe C2TE - S1).	Adesivi cementizi migliorati resistenti allo scivolamento e deformabili (classe C2FT - S1). ●
		≥ 30x30 cm < 60x60 cm ●●	Adesivi cementizi migliorati, resistenti allo scivolamento, a tempo aperto allungato e deformabili (classe C2TE - S1).	Adesivi cementizi migliorati resistenti allo scivolamento e deformabili (classe C2FT - S1). ●
		≥ 60x60 cm ●●	Adesivi cementizi migliorati, a tempo aperto allungato e altamente deformabili (classe C2E - S2).	Adesivi cementizi migliorati e altamente deformabili (classe C2F - S2). ●

- Nel caso di posa in condizioni di basse temperature oppure qualora sia necessario mettere in esercizio rapidamente il rivestimento ceramico è preferibile l'utilizzo di adesivi cementizi migliorati a presa rapida (Classe C2F – EN 12004).
- Nel caso di piastrelle con un lato maggiore di 30 cm posate ad altezze superiori ai 3 metri, alcune normative internazionali prevedono l'utilizzo di un ancoraggio meccanico supplementare che assicuri la ritenzione della piastrella in caso accidentale di distacco, da scegliere in relazione al peso della piastrella, all'altezza del rivestimento ed alle condizioni del cantiere.

2. STESURA DEGLI ADESIVI E POSA DELLE PIASTRELLE:

Nel caso di posa di piastrelle con un lato di lunghezza maggiore di 60 cm e in ogni caso per ambienti interni commerciali oppure all'esterno è fondamentale applicare l'adesivo con il sistema della doppia spalmatura applicando la colla linearmente in direzione parallela al lato corto. E' fondamentale che sia parallela la direzione di applicazione dell'adesivo sul supporto di posa a quella applicata sul retro della piastrella, garantendo così la perfetta aderenza all'interfaccia piastrella ceramica-supporto.

Per minimizzare i dislivelli del sistema piastrellatura sia a pavimento che a rivestimento si raccomanda l'adozione di "sistemi di posa facilitata" con distanziatori e livellatori.

Applicare l'adesivo sul supporto mediante spatola di idonea dentatura.

3. FUGA E STUCCATURA

Si sconsiglia la posa a giunto unito ovvero posa con fughe inferiori ai 2 mm.

Nel caso di posa "a correre" il massimo sfalsamento tra piastrelle non deve superare 1/3 della lunghezza del lato adiacente.

Si raccomanda di seguire le indicazioni dei migliori produttori di stucchi per fughe.

DESTINAZIONE D'USO	STUCCHI CONSIGLIATI - Normativa Europea EN 13888
Ambienti interni residenziali	Malte cementizie per fughe migliorate (Classe CG2)
Ambienti umidi interni (bagni, docce) ed ambienti esterni	Malte cementizie per fughe migliorate con assorbimento di acqua ridotto (classe CG2 WA)
Ambienti ad uso commerciale	Malte cementizie per fughe migliorate con elevata resistenza all'abrasione (classe CG2 A)
Ambienti in cui sia richiesta totale igiene e resistenza agli agenti chimici (piscine, piani di lavoro di cucine, industrie alimentari, ospedali, supermercati, ecc...)	Malte epossidiche (classe FG).

3a. ELIMINAZIONE DELLO STUCCO IN ECCESSO

Per una corretta ed agevole eliminazione degli eccessi di stucco, si raccomanda di seguire le indicazioni del produttore dello stucco. In generale, si consiglia di attenersi a quanto segue.

Stucchi cementizi

Quando lo stucco diventa opaco (normalmente dopo 10-20 minuti), pulire con una spugna di cellulosa dura con movimenti diagonali rispetto alle fughe. E' importante il rispetto di questi tempi per non rischiare di rimuovere lo stucco dalle fughe.

Stucchi epossidici

A impasto ancora fresco, bagnare abbondantemente la superficie emulsionando con un tampone tipo Scotch-Brite®, facendo attenzione a non svuotare le fughe. Il residuo liquido di stucco può essere rimosso con una spugna di cellulosa dura (da sostituire se troppo impregnata di resina). E' fondamentale rimuovere lo stucco epossidico tempestivamente prima che inizi ad indurirsi, in quanto la successiva rimozione risulterebbe estremamente difficile. Nel caso in cui lo stucco epossidico abbia già iniziato a indurirsi, provare ad aggiungere all'acqua di lavaggio il 10% di alcool.

4. PULIZIA E MANUTENZIONE

4a. PULIZIA DI FINE CANTIERE

Dopo alcuni giorni, eliminare i residui di cantiere con spugna commerciale tipo Scotch-Brite® oppure con spazzolone o monospazzola (per grandi superfici).

Per i rivestimenti, utilizzare un detergente neutro diluito in acqua calda.

Per i pavimenti, utilizzare un detergente acido ad azione tamponata, in percentuale di diluizione variabile in funzione del tipo di superficie (liscia oppure strutturata).

E' importante proteggere preventivamente eventuali inserti in marmo o metallo con nastro adesivo.

Risciacquare poi abbondantemente con acqua calda pulita, sino alla eliminazione di qualsiasi alonatura o residuo negli interstizi.

Se necessario, ripetere il lavaggio acido a concentrazioni più elevate ad eccezione del caso in cui siano presenti inserti in marmo o metallo. Evitare l'utilizzo di acidi da ferramenta diluiti.

4b. MANUTENZIONE ORDINARIA

Si consiglia l'utilizzo di un comune detergente neutro diluito in acqua.

Evitare l'utilizzo di prodotti acidi, alcalini, ceranti e/o impregnanti e pagliette di metallo (spugnette di ferro e acciaio).

In caso di sporchi più intensi o di superfici particolarmente strutturate, usare un detergente a base alcalina risciacquando al termine del lavaggio.

Per le grandi superfici è consigliabile l'utilizzo di macchine lavasciuga.

4c. MANUTENZIONE STRAORDINARIA

Nel caso di tracce di sporco resistenti alla pulizia ordinaria, si raccomanda l'utilizzo di un detergente adeguato in funzione del tipo di sporco.

TIPO DI SPORCO (resistente alla manutenzione ordinaria)	DETERGENTE/SOLVENTE
Carbone, efflorescenze calcaree, gesso, segni metallici, ruggine, grafite, tempere murali	Detergenti a base acida *
Coca cola, caffè, vino, birra, gelato	Detergenti a base alcalina
Resine, oli silicnici o meccanici, cere di candela, vernice	Solventi
Pneumatici, suole di gomma, alonature di ventose	Detergenti basici in pasta abrasiva

* Attenzione: i prodotti a base acida possono corrodere marmo, granito, pietre naturali e metalli, pertanto evitarne l'uso nel caso di decori o inserti realizzati con questi materiali.

Le caratteristiche di pulibilità dei materiali variano in modo significativo per le diverse modalità d'installazione, condizioni d'uso, tipologie di superfici e ambiente. In linea generale, all'aumentare delle caratteristiche di antiscivolo delle piastrelle aumentano le difficoltà di pulizia.

L'operatore professionale incaricato dell'intervento di manutenzione e pulizia dovrà sempre procedere ad una preliminare verifica empirica (possibilmente su una porzione di materiale non posato) per ogni singolo tipo di intervento.

In caso di condizioni d'uso particolarmente gravose (ad esempio, officine meccaniche o ambienti con forte presenza di residui oleosi e tracce di pneumatico), di errata installazione o di pulizie effettuate in modo inadeguato, Atlas Concorde declina ogni responsabilità in merito all'efficacia delle operazioni di pulizia e manutenzione.

Resta inteso che Atlas Concorde non potrà essere ritenuta responsabile per eventi, danni o difetti dovuti ad errata installazione, negligente pulizia e manutenzione, o inadeguata scelta della tipologia dei materiali installati e degli adesivi utilizzati con riguardo alla destinazione.

Per maggiori informazioni si rimanda al "Manuale di Posa, Uso, Pulizia e Manutenzione".

CONSEILS POUR LA POSE

Avant toute pose, il est recommandé de s'assurer que le support est suffisamment sec, plan et propre.

1. CHOIX DE LA COLLE

Pour une pose de qualité, il est fondamental d'utiliser une colle appropriée. Toujours respecter les indications fournies par les meilleurs producteurs de colle pour la pose de carreaux céramiques.

Les facteurs ci-après permettent généralement d'identifier l'adhésif le plus approprié :

- type de support ;
- type et format du carrelage ;
- type d'application du revêtement céramique (sol/mur ; intérieur/extérieur) ;
- conditions climatiques au moment de la pose ;
- temps disponible pour la mise en service du revêtement céramique.

TYPE D'APPLICATION Type de support	TYPE DE CARRELAGE Typologie	FORMAT: (cm)	ADHÉSIFS RECOMMANDÉS Normes Européennes En 12004	
			Séchage normal:	Séchage rapide
REVÊTEMENTS DE SOL INTÉRIEURS				
Chapes à base de ciment Revêtements de sol en ciment déjà existants (damés, bouchardés) Chapes anhydrite (Après application d'un primaire approprié) Chapes chauffantes Revêtements de sol déjà existants (Céramique, carreaux de marbre et pierres naturelles) Imperméabilisation salles de bains	carreaux en grès cérame	< 30x30 cm	Mortiers-colles améliorés, à temps ouvert allongé (classe C2E).	Mortiers-colles améliorés résistant au glissement et déformables (classe C2FT - S1). ●
		≤ 30x30 cm < 60x60 cm	Mortiers-colles améliorés résistant au glissement, à temps ouvert allongé (classe C2TE).	Mortiers-colles améliorés résistant au glissement et déformables (classe C2FT - S1). ●
		≥ 60x60 cm	Mortiers-colles améliorés, à temps ouvert allongé et déformables (classe C2E - S1).	Mortiers-colles améliorés résistant au glissement et déformables (classe C2FT - S1). ●
REVÊTEMENTS DE MUR INTÉRIEURS				
Enduit à base de ciment ou mortier Plâtre (enduits ou panneaux, après application d'un primaire approprié) Béton coulé Plâtre cartoné (Après avoir appliqué de l'amorçant sur les joints base plâtre) Imperméabilisation salles de bains et douches Carrelages céramiques déjà existants	carreaux à pâte blanche carreaux en grès cérame	tous formats	Mortiers-colles améliorés résistant au glissement, à temps ouvert allongé (classe C2TE).	Mortiers-colles améliorés résistant au glissement et déformables (classe C2FT - S1). ●
		< 30x30 cm	Mortiers-colles améliorés résistant au glissement, à temps ouvert allongé (classe C2TE).	Mortiers-colles améliorés résistant au glissement et déformables (classe C2FT - S1). ●
		≤ 30x30 cm < 60x60 cm	Mortiers-colles améliorés résistant au glissement, à temps ouvert allongé (classe C2TE).	Mortiers-colles améliorés résistant au glissement et déformables (classe C2FT - S1). ●
≥ 60x60 cm	Mortiers-colles améliorés résistant au glissement, à temps ouvert allongé et déformables (classe C2TE - S1).	Mortiers-colles améliorés résistant au glissement et déformables (classe C2FT - S1). ●		
REVÊTEMENTS DE SOL EXTÉRIEURS				
Chapes à base de ciment Dallage en béton Couches d'imperméabilisation	carreaux en grès cérame	< 30x30 cm	Mortiers-colles améliorés résistant au glissement, à temps ouvert allongé (classe C2TE).	Mortiers-colles améliorés résistant au glissement et déformables (classe C2FT - S1). ●
		≤ 30x30 cm < 60x60 cm	Mortiers-colles améliorés résistant au glissement, à temps ouvert allongé et déformables (classe C2TE - S1).	Mortiers-colles améliorés résistant au glissement et déformables (classe C2FT - S1). ●
		≥ 60x60 cm	Mortiers-colles améliorés, à temps ouvert allongé et hautement déformables (classe C2E - S2).	Mortiers-colles améliorés, à temps ouvert allongé et hautement déformables (classe C2E - S2). ●
REVÊTEMENTS DE MUR EXTÉRIEURS				
Enduit à base de ciment Béton coulé sur place ou préfabriqué	carreaux en grès cérame	< 30x30 cm	Mortiers-colles améliorés résistant au glissement, à temps ouvert allongé et déformables (classe C2TE - S1).	Mortiers-colles améliorés résistant au glissement et déformables (classe C2FT - S1). ●
		≥ 30x30 cm < 60x60 cm ●●	Mortiers-colles améliorés résistant au glissement, à temps ouvert allongé et déformables (classe C2TE - S1).	Mortiers-colles améliorés résistant au glissement et déformables (classe C2FT - S1). ●
		≥ 60x60 cm ●●	Mortiers-colles améliorés, à temps ouvert allongé et hautement déformables (classe C2E - S2).	Mortiers-colles améliorés et hautement déformables (classe C2F - S2). ●

- En cas de pose à basse température ou bien de mise en service rapide du revêtement céramique, il est préférable d'utiliser des mortiers-colles améliorés à prise rapide (Classe C2F – EN 12004).
- En cas de carreaux de côté dépassant 30 cm appliqués à des hauteurs de plus de 3 mètres, certaines normes internationales exigent l'utilisation d'un ancrage mécanique supplémentaire, pour assurer la rétention du carreau en cas de décollage accidentel. Ceux-ci doivent être choisis en fonction du poids du carreau, de la hauteur du revêtement et des conditions sur le chantier.

2. APPLICATION DES COLLES ET POSE DU CARRELAGE

En cas de pose de carreaux ayant un côté de longueur supérieure à 60 cm, ainsi qu'en cas de pose à l'intérieur d'espaces commerciaux ou de pose en extérieur, il est fondamental d'appliquer la colle avec le système du double encollage en appliquant la colle de manière linéaire et parallèle au côté court. Il est fondamental que le sens d'application de la colle sur le support de la pose soit parallèle à celui appliqué au dos du carreau, en garantissant ainsi une adhérence parfaite entre le carreau et le support. Pour réduire tout éventuel décalage du carrelage sur le sol et sur le mur, il est recommandé d'adopter des "systèmes de pose facilitée" en utilisant des croisillons et des niveleurs. Appliquer l'adhésif sur le support avec une spatule à dents adéquates.

3. JOINT ET MASTICAGE

Il est déconseillé d'effectuer des poses à bords unis, à savoir dont les joints sont inférieurs à 2 mm.

En cas de pose "en succession", le décalage maximum entre les carreaux ne doit pas dépasser 1/3 de la longueur du côté adjacent.

Il est recommandé de respecter les indications fournies par les meilleurs producteurs de mortiers pour joints.

TYPE D'APPLICATION	MORTIERS RECOMMANDÉS - Norme Européenne En 13888
Espaces résidentiels intérieurs	Mortiers à base de ciment pour joints améliorés (Classe CG2)
Espaces humides intérieurs (salles de bains, douches) et espaces extérieurs	Mortiers à base de ciment pour joints améliorés à faible absorption d'eau (Classe CG2 WA)
Espaces à usage commercial	Mortiers à base de ciment pour joints améliorés, hautement résistants à l'abrasion (Classe CG2 A)
Espaces nécessitant une hygiène totale et une résistance aux agents chimiques (piscines, plans de travail de cuisines, industries alimentaires, hôpitaux, supermarchés, etc.)	Mortiers époxy (Classe FG).

3a. ÉLIMINATION DU MORTIER EXCÉDENTAIRE

Toujours respecter les indications du fabricant de mortier pour pouvoir éliminer correctement et facilement le produit excédentaire. Il est généralement recommandé de procéder de la façon suivante:

Mortiers à base de ciment

Dès que le mortier devient opaque (généralement au bout de 10-20 minutes), nettoyer à l'aide d'une éponge en cellulose dure en faisant des mouvements diagonaux par rapport aux joints. Il est important de respecter le temps indiqué pour ne pas risquer de retirer le mortier des joints.

Mortiers époxy

Lorsque le mélange est encore frais, mouiller abondamment la surface et émulsionner avec un tampon de type Scotch-Brite® en veillant bien à ne pas vider les joints.

Le résidu liquide de mortier peut s'enlever à l'aide d'une éponge en cellulose dure (à remplacer si elle est trop imprégnée de résine).

Il est fondamental d'éliminer le mortier époxy à temps, avant qu'il ne commence à durcir, après quoi l'opération s'avère extrêmement difficile. Si le mortier a déjà commencé à prendre, essayer d'ajouter 10% d'alcool à l'eau de lavage.

4.NETTOYAGE ET ENTRETIEN

4a. NETTOYAGE EN FIN DE CHANTIER

Au bout de plusieurs jours, nettoyer les résidus de chantier à l'aide d'une éponge commerciale Scotch-Brite® d'un balai-brosse ou d'un balai d'atelier (pour grandes surfaces). Pour les revêtements de mur, utiliser un produit détergent neutre, dilué dans de l'eau chaude.

Pour les revêtements de sol, utiliser un produit détergent acide à effet tampon en variant le pourcentage de dilution selon le type de surface (lisse ou structurée). Il est important de protéger préalablement tout insert en marbre ou en métal avec du ruban adhésif.

Rincer ensuite abondamment avec de l'eau chaude propre jusqu'à ce qu'il n'y ait plus d'auroles ni de résidus dans les interstices.

Répéter si nécessaire le lavage acide à des concentrations plus élevées (s'abstenir s'il y a des inserts en marbre ou en métal). Éviter toute utilisation d'acides commerciaux dilués.

4b. ENTRETIEN ORDINAIRE

Il est recommandé d'utiliser un produit détergent ordinaire, neutre et dilué dans de l'eau.

Éviter toute utilisation d'acides, alcalins, produits de cirage et/ou imprégnants, pailles de fer et éponges métalliques en fer et en acier.

En cas de saleté plus consistante ou de surfaces particulièrement structurées, utiliser un produit détergent à base alcaline et rincer en fin de lavage.

Pour les grandes surfaces, il est recommandé d'utiliser des machines laveuses et sécheuses.

4c. ENTRETIEN EXTRAORDINAIRE

En cas de saleté résistant au nettoyage ordinaire, il est recommandé d'utiliser un produit détergent adapté au type de saleté.

TYPE DE SALETÉ (résistant à l'entretien ordinaire)	DÉTERGENT/SOLVANT
Charbon, efflorescences calcaires, plâtre, signes métalliques, rouille, graphite, peintures murales à la détrempe	Détergents à base acide *
Coca-cola, café, vin, bière, glace	Détergents à base alcaline
Résines, huiles silicones ou mécaniques, cire de bougie, peinture	Solvants
Pneus, semelles en caoutchouc, auroles provoquées par des ventouses	Détergents basiques en pâte abrasive

* Attention : les produits à base d'acide peuvent ronger le marbre, le granit, les pierres naturelles et les métaux, par conséquent ne pas les utiliser en présence de décors ou d'inserts réalisés avec ces types de matériaux.

Toutefois, les caractéristiques de nettoyabilité des matériaux peuvent varier de façon significative selon les modalités de pose, les conditions d'utilisation, les types de surfaces et de lieux. Généralement, plus les caractéristiques antidérapantes des carreaux sont élevées, plus le nettoyage est difficile.

Avant chaque intervention, l'opérateur professionnel chargé de l'entretien et du nettoyage devra toujours effectuer un contrôle empirique (si possible sur une portion de matériau non posée).

Atlas Concorde décline toute responsabilité quant à l'efficacité des opérations de nettoyage et d'entretien en cas de poses ou de nettoyages défectueux ainsi que dans des conditions d'utilisation particulièrement difficiles (par exemple, dans des ateliers de mécaniciens ou dans des endroits avec des résidus huileux importants et des traces de pneu).

Il est entendu qu'Atlas Concorde ne saurait être tenue pour responsable d'événements, de dommages ou de vices dus à une pose défectueuse, un nettoyage et un entretien négligés ou un mauvais choix du matériau ou des adhésifs pour l'usage considéré.

Pour plus d'informations, consulter le "Manuel de pose, d'emploi, d'entretien et de nettoyage".

VERLEGETIPPS

Vor Beginn der Verlegung sicherstellen, dass der Untergrund ausreichend verlegereif, eben und einwandfrei sauber ist.

1. WAHL DES KLEBERS

Der Gebrauch eines geeigneten Klebers ist für die Verlegung von grundlegender Bedeutung. Befolgen Sie die Angaben der führenden Kleberhersteller für die Verlegung von Keramikfliesen.

In der Regel kann der geeignetste Kleber aufgrund der folgenden Faktoren bestimmt werden:

- Art des Untergrunds;
- Fliesentyp und Fliesenformat;
- Gebrauchsbestimmung der Fliesen (Boden-/Wandbelag; Innen-/Außenbereich);
- klimatische Bedingungen bei der Verlegung;
- verfügbare Zeiten für die Inbetriebnahme des Belags.

GEBRAUCHSBESTIMMUNG Art des Untergrunds	FLIESENTYP Typ	FORMAT (cm)	EMPFOHLENE KLEBER - Europäische Normen EN 12004	
			Normal Abbindend	Schnell Abbindend
BÖDEN IM INNENBEREICH				
Zementestriche Bestehende Bodenbeläge (gebundene, verdichtete Betonuntergründe)	Feinsteinzeugfliesen	< 30x30 cm	Vergütete Zementkleber mit verlängerter kleboffener Zeit (Klasse C2E).	Vergütete, standfeste und flexible Zementkleber (Klasse C2FT - S1). ●
Anhydritestriche (nach entsprechender Behandlung mit Primer)		≤ 30x30 cm < 60x60 cm	Vergütete, standfeste, flexible Zementkleber mit verlängerter kleboffener Zeit gemäß und Verformbarkeit gemäß (Klasse C2TE).	Vergütete, standfeste und flexible Zementkleber (Klasse C2FT - S1). ●
Heizestriche Bestehende Bodenbeläge aus Keramik, Terrazzo, Naturstein Abdichtung in Nassräumen		≥ 60x60 cm	Vergütete, flexible Zementkleber mit verlängerter kleboffener Zeit gemäß und Verformbarkeit gemäß (Klasse C2E - S1).	Vergütete, standfeste und flexible Zementkleber (Klasse C2FT - S1). ●
WANDBELÄGE IM INNENBEREICH				
Zementputz oder Mörtel Gips (Putze oder Platten, nach entsprechender Behandlung mit Primer) Ortbeton Gipskarton (Auf gipshaltige Fugen vorher Primer auftragen) Abdichtung in Bädern und Duschen Bestehende Keramikfliesen	Weißscherbige Fliesen	Alle Formate	Vergütete, standfeste, flexible Zementkleber mit verlängerter kleboffener Zeit gemäß und Verformbarkeit gemäß (Klasse C2TE).	Vergütete, standfeste und flexible Zementkleber (Klasse C2FT - S1). ●
	Feinsteinzeugfliesen	< 30x30 cm	Vergütete, standfeste, flexible Zementkleber mit verlängerter kleboffener Zeit gemäß und Verformbarkeit gemäß (Klasse C2TE).	Vergütete, standfeste und flexible Zementkleber (Klasse C2FT - S1). ●
		≤ 30x30 cm < 60x60 cm	Vergütete, standfeste, flexible Zementkleber mit verlängerter kleboffener Zeit gemäß und Verformbarkeit gemäß (Klasse C2TE).	Vergütete, standfeste und flexible Zementkleber (Klasse C2FT - S1). ●
		≥ 60x60 cm	Vergütete, standfeste, flexible Zementkleber mit verlängerter kleboffener Zeit gemäß und Verformbarkeit gemäß (Klasse C2TE - S1).	Vergütete, standfeste und flexible Zementkleber (Klasse C2FT - S1). ●
BÖDEN IM AUSSENBEREICH				
Zementestriche Betonuntergrund Abdichtschichten	Feinsteinzeugfliesen	< 30x30 cm	Vergütete, standfeste Zementkleber mit verlängerter kleboffener Zeit (Klasse C2TE).	Vergütete, standfeste und flexible Zementkleber (Klasse C2FT - S1). ●
		≤ 30x30 cm < 60x60 cm	Vergütete, standfeste, flexible Zementkleber mit verlängerter kleboffener Zeit gemäß und Verformbarkeit gemäß (Klasse C2TE - S1).	Vergütete, standfeste und flexible Zementkleber (Klasse C2FT - S1). ●
		≥ 60x60 cm	Vergütete, hochflexible Zementkleber mit verlängerter kleboffener Zeit gemäß und Verformbarkeit gemäß (Klasse C2E - S2).	Vergütete, hochflexible Zementkleber mit verlängerter kleboffener Zeit gemäß und Verformbarkeit gemäß (Klasse C2FE - S2). ●
AUSSENWANDBELÄGE				
Zementputz Ortbeton und Fertigbeton	Feinsteinzeugfliesen	< 30x30 cm	Vergütete, standfeste, flexible Zementkleber mit verlängerter kleboffener Zeit gemäß und Verformbarkeit gemäß (Klasse C2TE - S1).	Vergütete, standfeste und flexible Zementkleber (Klasse C2FT - S1). ●
		≥ 30x30 cm < 60x60 cm ●●	Vergütete, standfeste, flexible Zementkleber mit verlängerter kleboffener Zeit gemäß und Verformbarkeit gemäß (Klasse C2TE - S1).	Vergütete, standfeste und flexible Zementkleber (Klasse C2FT - S1). ●
		≥ 60x60 cm ●●	Vergütete, hochflexible Zementkleber mit verlängerter kleboffener Zeit gemäß und Verformbarkeit gemäß (Klasse C2E - S2).	Vergütete und hochflexible Zementkleber (Klasse C2F - S2). ●

- Bei der Verlegung bei niedrigen Temperaturen oder falls eine rasche Inbetriebnahme des Belags erforderlich ist, wird der Gebrauch von schnell abbindenden zementären Kleb morteln mit verbesserter Haftung (Klasse C2F – EN 12004) empfohlen.
- Für Fliesen mit langer Seite über 30 cm, die in einer Höhe von über 3 Metern verlegt werden, schreiben einige internationale Vorschriften eine zusätzliche mechanische Verankerung vor, die die Fliese bei unbeabsichtigter Ablösung zurückhält und je nach Fliesengewicht, Belagshöhe und Baustellenbedingungen gewählt werden müssen.

2. AUFTRAG DER KLEBER UND VERLEGUNG DER FLIESEN

Bei Fliesen mit einer langen Seite von mehr als 60 cm und in jedem Fall in gewerblich genutzten Innenräumen sowie bei der Verlegung im Freien ist der Kleber unbedingt mit dem Buttering-Floating-Verfahren aufzutragen, wobei er linear parallel zur kurzen Seite aufzuziehen ist. Es ist unerlässlich, dass die Auftragsrichtung des Klebers auf dem Untergrund und jene auf der Fliesenrückseite parallel zueinander sind, da dies ein perfektes Anhaften der Verbindung zwischen Keramikfliese und Untergrund gewährleistet.

Zur Reduzierung von Unebenheiten im Fliesenbelag an Wand und Boden empfiehlt es sich, Verlegehilfen wie Distanzstücke und Nivellierelemente zu verwenden.

Den Kleber mit Spachtel mit geeigneter Zahnung auf den Untergrund auftragen.

3. EMPFOHLENE FUGENMASSEN

Von der fugenlosen Verlegung bzw. von einer Fugenbreite unter 2 mm wird abgeraten.

Bei fortlaufender Längsverlegung dürfen die Fliesen nicht um mehr als 1/3 der Länge der jeweils angrenzenden Seiten versetzt werden.

Befolgen Sie die Angaben der führenden Fugenmassenhersteller.

GEBRAUCHSBESTIMMUNG	EMPFOHLENE FUGENMASSEN - EUROPÄISCHE NORM EN 13888
Innenbereich in privaten Objekten	Vergütete Fugenmörtel (Klasse CG2)
Nassräume im Innenbereich (Badezimmer, Duschen) und im Außenbereich	Zementäre Fugenmörtel mit verbesserten Eigenschaften und reduzierter Wasseraufnahme (Klasse CG2 WA)
Innenbereich in gewerblichen Objekten	Zementäre Fugenmörtel mit verbesserten Eigenschaften und hoher Abriebfestigkeit (Klasse CG2 A)
Bereiche, in denen es auf absolute Hygiene und Chemikalienbeständigkeit ankommt (Schwimmbäder, Arbeitsplatten in Küchen, Lebensmittelindustrie, Krankenhäuser, Supermärkte etc.).	Epoxidharzfugenmörtel (Klasse RG).

3a. ENTFERNEN DER ÜBERSCHÜSSIGEN FUGENMASSE

Für die korrekte und problemlose Entfernung von überschüssiger Fugenmasse die Angaben des Herstellers befolgen. Generell wird empfohlen, folgende Anweisungen zu beachten.

Zementäre Fugenmörtel

Wenn die Fugenmasse nicht mehr glänzt (normalerweise nach 10-20 Minuten), mit einem harten Zelluloseschwamm diagonal zum Fugenverlauf reinigen. Diese Zeiten müssen beachtet werden, um ein Entfernen der Fugenmasse aus den Fugen zu vermeiden.

Epoxidharz-Fugenmörtel

Bei noch frischer Masse die Oberfläche mit viel Wasser annässen und mit einem Pad vom Typ Scotch-Brite® bearbeiten; darauf achten, dass die Fugen nicht ausgewaschen werden.

Die flüssigen Fugenmassenreste mit einem harten Zelluloseschwamm (zu ersetzen, falls zu sehr mit Harz imprägniert) entfernen.

Wichtig ist es, dass die Epoxidharz-Fugenmasse rechtzeitig entfernt wird, bevor sie auszuhärten beginnt, da sie danach nur sehr schwer beseitigt werden kann. Falls die Epoxidharz-Fugenmasse bereits begonnen hat auszuhärten, kann man versuchen, dem Waschwasser 10 % Alkohol beizumengen.

4. REINIGUNG UND PFLEGE

4a. BAUSCHLUSSREINIGUNG

Nach einigen Tagen die Rückstände mit Scotch-Pad® oder mit einer Bürste bzw. einer Einscheiben-Bodenreinigungsmaschine (bei großen Flächen) entfernen.

Für die Wandbeläge einen mit warmem Wasser verdünnten neutralen Reiniger verwenden.

Für die Bodenbeläge ein saures Reinigungsmittel mit Pufferwirkung verwenden, das je nach Oberfläche (glatt oder strukturiert) zu verdünnen ist. Wichtig ist es, dass eventuelle Marmor- oder Metalleinleger vorsorglich mit Klebeband geschützt werden.

Danach mit reichlich warmem und sauberem Wasser nachspülen, bis Schleier und Schmutz restlos entfernt sind.

Gegebenenfalls die Reinigung mit einer stärker konzentrierten Säurelösung wiederholen; bei Marmor- oder Metalleinlegern ist dies jedoch zu vermeiden. Keine verdünnten Säuren für Eisenwaren verwenden.

4b. NORMALE PFLEGE

Für die Pflege wird ein gewöhnlicher, mit Wasser verdünnter neutraler Reiniger empfohlen.

Saure oder alkalische Produkte, Wachs- und/oder Imprägniermittel sowie Stahlwolle pads (Eisen- und Stahlschwämme) sind zu vermeiden.

Bei hartnäckiger Verschmutzung oder besonders strukturierten Oberflächen einen alkalischen Reiniger verwenden und nach dem Reinigen nachspülen.

Bei großen Flächen empfiehlt sich die Verwendung einer Bodenreinigungsmaschine.

4c. SONDERREINIGUNG

Bei durch normale Pflege nicht zu beseitigender Verschmutzung wird der Gebrauch eines für die jeweilige Schmutzart geeigneten Reinigers empfohlen.

SCHMUTZART (hartnäckig gegen normale Pflegeprodukte)	REINIGER/LÖSEMittel
Kohle, Kalkausblühungen, Gips, Metallabrieb, Rost, Graphit, Wandanstriche	Saure Reiniger*
Coca-Cola, Kaffee, Wein, Bier, Speiseeis	Alkalische Reiniger
Kunstharz, Silikon und mechanisches Öl, Kerzenwachs, Lack	Lösemittel
Gummiabrieb (Reifen, Schuhsohlen, Abdrücke von Saugnapfen)	Basische Reiniger (Scheuerpaste)

* Achtung: Produkte auf Säurebasis können Marmor, Granit, Naturstein und Metalle angreifen. Bei Einlegern oder Dekorfliesen aus diesen Materialien sind sie deshalb zu vermeiden.

Die Eigenschaften hinsichtlich der Reinigbarkeit der Materialien variieren allerdings erheblich je nach Verlegungsart, Einsatzbedingungen, Oberfläche und Umgebung. In der Regel sind Bodenbeläge mit zunehmender Rutschhemmung schwerer zu reinigen.

Die mit der Pflege und Reinigung beauftragte Fachkraft muss für einen jeden Eingriff immer eine empirische Vorabkontrolle vornehmen (möglichst auf nicht verlegtem Material).

Bei besonders schwierigen Einsatzbedingungen (z.B. in Werkstätten oder bei Vorliegen von stark öliger Verschmutzung und Reifenspuren), falscher Verlegung oder unsachgemäß ausgeführter Reinigung übernimmt Atlas Concorde keine Haftung für die Wirksamkeit der Reinigungs- und Pflegearbeiten.

In keinem Fall ist Atlas Concorde für Ereignisse, Schäden oder Mängel verantwortlich, die auf eine falsche Verlegung, nachlässige Reinigung und Pflege oder auf eine ungeeignete Auswahl der verlegten Materialien und verwendeten Kleber für die jeweilige Gebrauchsbestimmung zurückzuführen sind.

Für weiterführende Informationen siehe das „Handbuch für Verlegung, Gebrauch, Reinigung und Pflege“.

SUGERENCIAS PARA LA COLOCACIÓN

Antes de empezar la operación de colocación, se aconseja asegurarse de que la superficie de apoyo esté suficientemente seca, plana y bien limpia.

1. ELECCIÓN DEL ADHESIVO

El empleo de un adhesivo adecuado tiene suma importancia para la colocación. Se aconseja atenerse a las indicaciones de los mejores productores de adhesivos para la colocación de baldosas cerámicas. Por lo general, el adhesivo más adecuado se identifica considerando los siguientes factores:

- tipo de soporte;
- tipología y formato de las baldosas;
- destino de uso (pavimento/revestimiento; interiores/exteriores) del revestimiento cerámico;
- condiciones climáticas en el momento de la colocación;
- tiempos a disposición para la puesta en uso del revestimiento cerámico.

DESTINO DE USO Tipo de soporte	TIPO DE BALDOSAS Tipología	FORMATO (cm)	ADHESIVOS RECOMENDADOS - Normativa Europea EN 12004	
			Toma normal	Toma rápida
PAVIMENTOS INTERNOS				
Morteros cementosos Pavimentos de cemento existentes (batido, bujardado) Bloques delgados de anhidrita (previa aplicación de un producto adecuado de imprimación) Morteros cementosos calefactores Pavimentos de cerámica, baldosas y piedras naturales existentes Impermeabilización en baños	gres porcelánico	< 30x30 cm	Adhesivos cementosos, mejorados con tiempo abierto prolongado (Clase C2E).	Adhesivos cementosos mejorados, resistentes al deslizamiento y deformables (Clase C2FT - S1). ●
		≤ 30x30 cm < 60x60 cm	Adhesivos cementosos mejorados, resistentes al deslizamiento con tiempo abierto prolongado (Clase C2TE).	Adhesivos cementosos mejorados, resistentes al deslizamiento y deformables (Clase C2FT - S1). ●
		≥ 60x60 cm	Adhesivos cementosos mejorados, con tiempo abierto prolongado y deformables (Clase C2E - S1).	Adhesivos cementosos mejorados, resistentes al deslizamiento y deformables (Clase C2FT - S1). ●
REVESTIMIENTOS INTERNOS				
Revoque de cemento o mortero, yeso (revoques o paneles, previa aplicación de un producto adecuado de imprimación) Colada de hormigón Yeso encartonado (Prevía aplicación de imprimación en las juntas a base de yeso) Impermeabilizaciones en baños y duchas Baldosas cerámica existentes	revestimientos de pasta blanca	Cualquier formato	Adhesivos cementosos mejorados, resistentes al deslizamiento con tiempo abierto prolongado (Clase C2TE).	Adhesivos cementosos mejorados, resistentes al deslizamiento y deformables (Clase C2FT - S1). ●
		< 30x30 cm	Adhesivos cementosos mejorados, resistentes al deslizamiento con tiempo abierto prolongado (Clase C2TE).	Adhesivos cementosos mejorados, resistentes al deslizamiento y deformables (Clase C2FT - S1). ●
		≤ 30x30 cm < 60x60 cm	Adhesivos cementosos mejorados, resistentes al deslizamiento con tiempo abierto prolongado (Clase C2TE).	Adhesivos cementosos mejorados, resistentes al deslizamiento y deformables (Clase C2FT - S1). ●
Morteros cementosos Solerías de hormigón Capas de impermeabilización	gres porcelánico	≥ 60x60 cm	Adhesivos cementosos mejorados, resistentes al deslizamiento con tiempo abierto prolongado y deformables (Clase C2TE - S1).	Adhesivos cementosos mejorados, resistentes al deslizamiento y deformables (Clase C2FT - S1). ●
		< 30x30 cm	Adhesivos cementosos mejorados, resistentes al deslizamiento con tiempo abierto prolongado (Clase C2TE).	Adhesivos cementosos mejorados, resistentes al deslizamiento y deformables (Clase C2FT - S1). ●
		≤ 30x30 cm < 60x60 cm	Adhesivos cementosos mejorados, resistentes al deslizamiento con tiempo abierto prolongado y deformables (Clase C2TE - S1).	Adhesivos cementosos mejorados, resistentes al deslizamiento y deformables (Clase C2FT - S1). ●
PAVIMENTOS EXTERNOS				
Morteros cementosos Solerías de hormigón Capas de impermeabilización	gres porcelánico	≥ 60x60 cm	Adhesivos cementosos mejorados, con tiempo abierto prolongado y altamente deformables (Clase C2E - S2).	Adhesivos cementosos mejorados, con tiempo abierto prolongado y altamente deformables (Clase C2FE - S2). ●
		< 30x30 cm	Adhesivos cementosos mejorados, resistentes al deslizamiento con tiempo abierto prolongado y deformables (Clase C2TE - S1).	Adhesivos cementosos mejorados, resistentes al deslizamiento y deformables (Clase C2FT - S1). ●
		≤ 30x30 cm < 60x60 cm	Adhesivos cementosos mejorados, resistentes al deslizamiento con tiempo abierto prolongado y deformables (Clase C2TE - S1).	Adhesivos cementosos mejorados, resistentes al deslizamiento y deformables (Clase C2FT - S1). ●
REVESTIMIENTOS EXTERNOS				
Revoque de cemento Colada de hormigón u hormigón prefabricado	gres porcelánico	≥ 30x30 cm < 60x60 cm ●●	Adhesivos cementosos mejorados, resistentes al deslizamiento con tiempo abierto prolongado y deformables (Clase C2TE - S1).	Adhesivos cementosos mejorados, resistentes al deslizamiento y deformables (Clase C2FT - S1). ●
		≥ 60x60 cm ●●	Adhesivos cementosos mejorados, con tiempo abierto prolongado y altamente deformables (Clase C2E - S2).	Adhesivos cementosos mejorados y altamente deformables (Clase C2F - S2). ●
		< 30x30 cm	s cementosos mejorados, resistentes al deslizamiento con tiempo abierto prolongado y deformables (Clase C2TE - S1).	Adhesivos cementosos mejorados, resistentes al deslizamiento y deformables (Clase C2FT - S1). ●

- En caso de colocación en condiciones de bajas temperaturas o bien si fuera necesario poner en uso rápidamente el revestimiento cerámico, es preferible el empleo de adhesivos cementosos mejorados de fraguado rápido (Clase C2F – EN 12004).
- Para baldosas con lado mayor a 30 cm colocadas a una altura superior a 3 metros, algunas normativas internacionales prevén el empleo de una fijación mecánica suplementaria que asegure la retención de la baldosa en caso de desprendimiento accidental, a elegir según el peso de la baldosa, la altura del revestimiento y las condiciones de la obra.

2. APLICACIÓN DE LOS ADHESIVOS Y COLOCACIÓN DE LAS BALDOSAS: RECOMENDACIONES

En caso de colocación de baldosas con un lado cuyo largo supere los 60 cm, y en cualquier caso para ambientes interiores comerciales o bien en el exterior, es fundamental aplicar el adhesivo con el sistema de doble esparcimiento, aplicando la cola de modo lineal en dirección paralela al lado corto. Es muy importante que la dirección de aplicación del adhesivo en el soporte de colocación sea paralela a la aplicada en el revés de la baldosa, garantizando la perfecta adherencia al interfaz baldosa cerámica y el soporte. Para minimizar los desniveles del sistema de embaldosado en pavimento o de azulejado en revestimiento, se les recomienda adoptar “sistemas de colocación facilitada” con distanciadores y niveladores. Aplicar el adhesivo sobre el soporte utilizando una espátula con un dentado adecuado.

3. ESTUCOS RECOMENDADOS

No se aconseja la colocación de junta unida o colocación con juntas menores a 2 mm.

En el caso de colocación “alternada de las juntas” el escalonado máximo entre las baldosas no tiene que superar 1/3 de la longitud del lado adyacente.

Se recomienda atenerse a las indicaciones de los mejores productores de estucos para juntas.

DESTINO DE USO	ESTUCOS RECOMENDADOS - NORMATIVA EUROPEA EN 13888
Ambientes internos residenciales	Morteros cementosos para juntas mejoradas (Clase CG2)
Ambientes húmedos internos (baños, duchas) y ambientes externos	Morteros cementosos para juntas mejoradas con una reducida absorción de agua (Clase CG2 WA)
Ambientes de uso comercial	Morteros cementosos para juntas mejoradas con una elevada resistencia a la abrasión (Clase CG2 A)
Ambientes en los cuales se requiera una higiene total y resistencia a los agentes químicos (piscinas, encimeras de cocinas, industrias alimenticias, hospitales, supermercados, etc...)	Morteros epoxídicos (Clase RG).

3a. ELIMINACIÓN DEL ESTUCO EN EXCESO

Para una eliminación correcta y sencilla de los residuos de estuco, se recomienda seguir las indicaciones del productor del mismo. Por lo general, se recomienda atenerse a las siguientes recomendaciones.

Estucos de cemento

Cuando el estuco se vuelve opaco (normalmente al cabo de 10-20 minutos), limpiar con una esponja de celulosa dura con movimientos diagonales respecto a las juntas. Es importante respetar estos tiempos para no correr el riesgo de quitar el estuco de las juntas.

Estucos epoxídicos

Con la pasta aún fresca, mojar bien la superficie emulsionando con un estropajo Scotch-Brite®, prestando atención para no vaciar las juntas. El residuo líquido de estuco puede eliminarse con una esponja de celulosa dura (que habrá que cambiar si está demasiado empapada de resina). Es importante eliminar el estuco epoxídico rápidamente antes de que empiece a fraguar, porque quitarlo más tarde resultaría muy difícil. Si el estuco epoxídico ya ha empezado a fraguar, añadir al agua de lavado el 10% de alcohol.

4. LIMPIEZA Y MANTENIMIENTO

4a. LIMPIEZA FINAL DE LA OBRA

Al cabo de algunos días, eliminar los restos de la obra con una esponja comercial Scotch-Brite® o bien con un cepillo grande o monocepillo (para grandes superficies).

Para los revestimientos, utilizar un detergente neutro diluido en agua caliente.

Para los pavimentos, utilizar un detergente ácido tamponado, diluido en un porcentaje variable según el tipo de superficie (lisa o estructurada). Es importante proteger preventivamente con cinta adhesiva las inserciones de mármol o metal si estuvieran presentes.

Aclarar abundantemente con agua caliente limpia hasta que desaparezca cualquier halo o residuo en los intersticios.

Si fuera necesario, repetir el lavado ácido con concentraciones más elevadas, excepto si estuvieran presentes inserciones de mármol o metal. Evitar el empleo de ácidos muriáticos de escasa calidad diluidos.

4b. MANTENIMIENTO ORDINARIO

Se recomienda el uso de un detergente neutro común diluido en agua.

Evitar el empleo de productos ácidos, alcalinos, productos para encerar y/o impermeabilizantes y bayetas de metal (esponjas de hierro y acero).

En caso de suciedad más intensa o superficies muy estructuradas, usar un detergente de base alcalina aclarando al final del lavado.

En caso de grandes superficies se recomienda el uso de máquinas de lavado y secado.

4c. MANTENIMIENTO EXTRAORDINARIO

En caso de restos de suciedad resistentes a la limpieza ordinaria se recomienda el uso de un detergente adecuado dependiendo del tipo de suciedad.

TIPO DE SUCIEDAD (resistente al mantenimiento ordinario)	DETERGENTE/DISOLVENTE
Carbón, eflorescencias calcáreas, yeso, marcas metálicas, óxido, grafito, pinturas murales al temple	Detergentes de base ácida *
Coca cola, café, vino, cerveza, helado	Detergente de base alcalina
Resinas, aceites silicónicos o mecánicos, cera de vela, pintura	Disolventes
Neumáticos, suelas de goma, halos de ventosas	Detergentes básicos en pasta abrasiva

* Atención: los productos de base ácida pueden corroer el mármol, el granito, las piedras naturales y los metales, por tanto hay que evitar su uso en caso de presencia de decoraciones o inserciones realizadas con estos materiales.

Las sugerencias facilitadas arriba son el resultado de investigaciones, comprobaciones de laboratorio y de una experiencia plurianual.

Sin embargo, las características de limpiabilidad de los materiales varían sensiblemente según las diferentes formas de instalación, las condiciones de uso, las tipologías de las superficies y el ambiente. Por lo general, cuanto mayores sean las características antideslizamiento de las baldosas, mayor será la dificultad para limpiarlas.

El profesional encargado del mantenimiento y la limpieza deberá siempre llevar a cabo una comprobación empírica previa (posiblemente en una porción de material no colocado) por cada tipo de intervención.

En caso de condiciones de uso especialmente pesadas (por ejemplo, en talleres mecánicos o en ambientes con una fuerte presencia de residuos oleosos y huellas de neumáticos), instalación incorrecta o limpieza efectuada de manera impropia, Atlas Concorde no se considera responsable de la eficacia de las operaciones de limpieza y mantenimiento.

Se da por descontado que Atlas Concorde no podrá ser considerada responsable de eventos, daños o defectos debidos a una instalación incorrecta, limpieza y mantenimiento negligentes o una elección inadecuada de los materiales instalados y los adhesivos utilizados con respecto al destino.

Para mayor información, consultar el “Manual de Colocación, Uso, Limpieza y Mantenimiento”.

РЕКОМЕНДАЦИИ ПО УКЛАДКЕ

Перед укладкой рекомендуется проверить, что поверхность основания достаточно выдержана, ровная и чистая.

1. ВЫБОР КЛЕЯ

Для качества укладки крайне важно правильно подобрать клей. Рекомендуется следовать указаниям крупнейших изготовителей клеев по укладке керамических плиток.

В целом, клей выбирают с учетом следующих критериев:

- тип основания;
- типология и формат плитки;
- назначение (пол/облицовка; внутри/снаружи) керамического покрытия;
- климатические условия в период укладки;
- время на выполнение керамического покрытия.

НАЗНАЧЕНИЕ Тип основания	ТИП ПЛИТКИ Типология	ФОРМАТ (cm)	РЕКОМЕНДУЕМЫЕ КЛЕИ - Европейские Нормы EN 12004	
			Стандартное схватывание	Быстрое схватывание
ВНУТРЕННИЕ НАПОЛЬНЫЕ ПОКРЫТИЯ				
Цементные стяжки Прежние цементные полы (утрамбованные) Ангидритные стяжки (предварительно нанести нужную грунтовку) Стяжки с подогревом Укладка на существующие полы из керамики, мраморных плиток и природного камня Гидроизоляция в ванных	Керамогранит	< 30x30 cm	Улучшенные клеи на цементной основе с увеличенным сроком хранения в открытом состоянии (Класс C2E).	Улучшенные эластичные клеи на цементной основе, стойкие к оползанию (Класс C2FT - S1). ●
		≤ 30x30 cm < 60x60 cm	Улучшенные клеи на цементной основе стойкие к оползанию с увеличенным сроком хранения в открытом состоянии (Класс C2TE).	Улучшенные эластичные клеи на цементной основе, стойкие к оползанию (Класс C2FT - S1). ●
		≥ 60x60 cm	Улучшенные клеи на цементной основе, стойкие к оползанию с увеличенным сроком хранения в открытом состоянии и эластичные (Класс C2E - S1).	Улучшенные эластичные клеи на цементной основе, стойкие к оползанию (Класс C2FT - S1).●
ВНУТРЕННЯЯ ОБЛИЦОВКА				
Цементная штукатурка или раствор Гипс (штукатурка или панели, предварительно нанести нужную грунтовку) Бетонная заливка Гипсовые панели (После нанесения грунтовки на гипсовые швы) Гидроизоляция в ванных и душах Прежние керамические плитки	плитка из белой глины	любой формат	Улучшенные клеи на цементной основе стойкие к оползанию с увеличенным сроком хранения в открытом состоянии (Класс C2TE).	Улучшенные эластичные клеи на цементной основе, стойкие к оползанию (Класс C2FT - S1). ●
		< 30x30 cm	Улучшенные клеи на цементной основе стойкие к оползанию с увеличенным сроком хранения в открытом состоянии (Класс C2TE).	Улучшенные эластичные клеи на цементной основе, стойкие к оползанию (Класс C2FT - S1). ●
		≤ 30x30 cm < 60x60 cm	Улучшенные клеи на цементной основе стойкие к оползанию с увеличенным сроком хранения в открытом состоянии (Класс C2TE).	Улучшенные эластичные клеи на цементной основе, стойкие к оползанию (Класс C2FT - S1). ●
Керамогранит		≥ 60x60 cm	Улучшенные клеи на цементной основе, стойкие к оползанию с увеличенным сроком хранения в открытом состоянии и эластичные (Класс C2E - S1).	Улучшенные эластичные клеи на цементной основе, стойкие к оползанию (Класс C2FT - S1). ●
		НАРУЖНЫЕ НАПОЛЬНЫЕ ПОКРЫТИЯ		
Цементные стяжки Бетонное перекрытие Гидроизоляционные слои	Керамогранит	< 30x30 cm	Улучшенные клеи на цементной основе стойкие к оползанию с увеличенным сроком хранения в открытом состоянии (Класс C2TE).	Улучшенные эластичные клеи на цементной основе, стойкие к оползанию (Класс C2FT - S1). ●
		≤ 30x30 cm < 60x60 cm	Улучшенные клеи на цементной основе, стойкие к оползанию с увеличенным сроком хранения в открытом состоянии и эластичные (Класс C2TE - S1)	Улучшенные эластичные клеи на цементной основе, стойкие к оползанию (Класс C2FT - S1).●
		≥ 60x60 cm	Улучшенные клеи на цементной основе, стойкие к оползанию с увеличенным сроком хранения в открытом состоянии и с большой эластичностью (Класс C2E - S2).	Улучшенные клеи на цементной основе, стойкие к оползанию с увеличенным сроком хранения в открытом состоянии и с большой эластичностью (Класс C2FE - S2). ●
НАРУЖНАЯ ОБЛИЦОВКА				
Цементная штукатурка Бетонная заливка на месте или бетонные блоки	Керамогранит	< 30x30 cm	Улучшенные клеи на цементной основе, стойкие к оползанию с увеличенным сроком хранения в открытом состоянии и эластичные (Класс C2TE - S1)	Улучшенные эластичные клеи на цементной основе, стойкие к оползанию (Класс C2FT - S1). ●
		≥ 30x30 cm < 60x60 cm ●●	Улучшенные клеи на цементной основе, стойкие к оползанию с увеличенным сроком хранения в открытом состоянии и эластичные (Класс C2TE - S1)	Улучшенные эластичные клеи на цементной основе, стойкие к оползанию (Класс C2FT - S1). ●
		≥ 60x60 cm ●●	Улучшенные клеи на цементной основе, стойкие к оползанию с увеличенным сроком хранения в открытом состоянии и с большой эластичностью (Класс C2E - S2).	Улучшенные высокоэластичные клеи на цементной основе (Класс C2F - S2). ●

- При укладке в условиях низкой температуры, если керамическое покрытие требуется быстро ввести в эксплуатацию, предпочтительнее применять быстрохватывающиеся улучшенные клеи на цементной основе (Класс C2F – EN 12004).
- Для плиток с длиной хотя бы одной из граней более 30 см, укладываемых на высоте более 3 метров, некоторые международные стандарты предусматривают дополнительное механическое крепление, например при помощи специальных крюков, для удержания плитки в случае случайного отрыва; крепеж подбирается с учетом веса плитки, высоты облицовки и конкретных условий стройплощадки.

2. НАНЕСЕНИЕ КЛЕЯ И УКЛАДКА ПЛИТКИ: РЕКОМЕНДАЦИИ

При укладке плитки с длиной хотя бы одной из граней более 60 см и, в любом случае, при укладке плитки в коммерческих помещениях или на улице, клей следует наносить в два слоя: на подлежащее облицовке основание и на тыльную сторону плиток прямыми полосами параллельно короткой грани. Важно, чтобы полосы клея, нанесенного на облицовываемое основание и на тыльную сторону плиток, были параллельны друг другу: это обеспечит оптимальное сцепление плиток с основанием.

Чтобы свести к минимуму неровности или перепады высот облицовки, как на полах, так и на стенах, рекомендуется использовать надлежащие крестики и

616 системы выравнивания плиток.

Наносить клей на основание шпателем с подходящим размером зубьев.

3. ШВЫ И ЗАТИРКА ШВОВ

Не рекомендуется укладывать плитку без швов или со швом менее 2 мм.

При укладке вразбежку смещение плиток должно быть не более 1/3 длины смежных граней.

При затирке швов следуйте указаниям крупнейших производителей шовных затирок.

НАЗНАЧЕНИЕ	РЕКОМЕНДУЕМЫЕ РАСТВОРЫ ЕВРОПЕЙСКИЕ НОРМАТИВЫ EN 13888
Внутренние жилые помещения	Улучшенные цементные растворы для швов (Класс CG2)
Внутренние помещения с высокой влажностью (ванные, души, бассейны и т.п.) и открытые помещения	Улучшенные цементные растворы для швов с низким водопоглощением (Класс CG2 W - EN 13888).
Помещения коммерческого назначения	Улучшенные цементные растворы для швов с повышенной стойкостью к истиранию (Класс CG2 Ar - EN 13888).
Помещения, где требуется полная гигиена и устойчивость к химическим агентам (рабочие столы на кухнях, пищевая промышленность, больницы, супермаркеты и т.п.)	Эпоксидные строительные растворы (Класс RG - EN 13888).

3а. УДАЛЕНИЕ ИЗЛИШКОВ ЗАТИРКИ

Чтобы легко и правильно удалить излишек раствора, рекомендуется следовать указаниям изготовителя раствора.

В общих чертах рекомендуется придерживаться нижеуказанного.

Цементные растворы

Когда раствор теряет блеск (обычно через 10-20 минут), счистить его губкой из твердой целлюлозы, проводя ей по диагонали относительно швов.

Очень важно выдержать указанное время, иначе есть риск удалить раствор из швов.

Эпоксидные растворы

Пока смесь свежая, обильно смочить поверхность, взбивая эмульсию тампоном Scotch-Brite®; действовать осторожно, чтобы не удалить раствор из швов.

Жидкие остатки раствора можно удалить его губкой из твердой целлюлозы (вовремя заменяя ее, когда она сильно пропитывается смолой). Крайне важно удалить эпоксидный раствор вовремя, пока он не начал затвердевать, так как в дальнейшем это будет чрезвычайно трудно сделать. Если эпоксидный раствор уже начал затвердеть, можно попробовать добавить 10% спирта в воду для смывания.

4. ЧИСТКА И УХОД

4а. ЧИСТКА ПО ЗАВЕРШЕНИИ УКЛАДКИ

Через несколько дней очистить уложенное покрытие губкой марки Scotch-Brite®, щеткой или механической щеткой (для больших площадей).

Для облицовки применять нейтральное моющее средство, растворенное в горячей воде. Для напольных покрытий применять кислотное моющее средство тампонирующего действия, концентрация раствора меняется в зависимости от типа поверхности (гладкая или шершавая). Не забывать предварительно защитить мраморные или металлические вставки с помощью клейкой ленты. Прополоскать обильным количеством чистой горячей воды, удаляя все разводы и остатки в промежутках. При необходимости повторить кислотную промывку с более сильной концентрацией, за исключением случаев, когда на полу имеются мраморные или металлические вставки. Избегать применения разведенных кислот для металлов.

4б. ТЕКУЩИЙ УХОД

Рекомендуется пользоваться обычным нейтральным моющим средством, разведенным в воде.

Избегать применения кислотных, щелочных, восковых средств, пропиток и металлических губок.

Для удаления сильных загрязнений или для очистки шершавой поверхности с сильно рельефной структурой пользоваться моющим средством на щелочной основе, прополаскивая после мытья.

Для уборки больших площадей рекомендуется пользоваться моечными машинами, которые выполняют мойку и сушку.

4с. ЧРЕЗВЫЧАЙНЫЙ УХОД

Если загрязнения не удаётся удалить обычным способом, рекомендуется применять моющее средство, подобранное с учетом типа загрязнения.

ТИП ЗАГРЯЗНЕНИЙ (устойчивых к обычной уборке)	МОЮЩЕЕ СРЕДСТВО/РАСТВОРИТЕЛЬ
Уголь, кальциевые налеты, гипс, следы от металлов, ржавчина, графит, стенная темпера	Моющие средства на кислотной основе *
Кока-кола, кофе, вино, пиво, мороженое	Моющие средства на щелочной основе
Смолы, силиконовые масла или масла для механического оборудования, свечной воск, краска	Растворители
Шины, резиновые подошвы, следы от присосок	Основания для очистки в виде абразивной пасты

* Внимание: средства на кислотной основе могут вызвать коррозию мрамора, гранита, природного камня и металлов, поэтому их не следует применять, если имеются декоры или вставки из этих материалов.

Приведенные выше рекомендации являются результатом исследований, лабораторных анализов и многолетнего опыта.

Тем не менее, легкость очистки покрытий значительно меняется при различных способах укладки, условиях эксплуатации, типологиях поверхности и окружающей среды. В целом, чем менее скользкая плитка, тем труднее ее очистить.

Профессиональный работник, отвечающий за уход и очистку, должен всегда провести предварительную пробу (по возможности, на неуложенном материале) по каждому отдельному виду работ.

В случае особо сложных условий (напр., механические мастерские или помещения с большим количеством масляных отходов и следов от шин), ошибок при укладке или неправильного проведения очистки фирма Atlas Concorde снимает с себя всякую ответственность за эффективность операций по очистке и уходу.

Оговаривается, что фирма Atlas Concorde не несет никакой ответственности за происшествя, ущерб или дефекты вследствие ошибок при укладке, халатной очистки и небрежного ухода или неправильного выбора типа устанавливаемых покрытий и клеев для конкретного назначения.

Больше информации приведено в руководстве по укладке, эксплуатации, чистке и уходу.

Serie Série Série Série Серия	Formato Size Format Format Formato Размер	Pezzi per scatola Pièces per carton Pièces par boîte Stückzahl x Kart. Piezas por caja шт. в коробке	M ² per scatola Sq mts per carton M ² par boîte Qm. pro Karton M ² por caja M ² в коробке	Box per pallet Box per pallet Boîtes per palette Karton pro Palette Cajas por palet Коробок на палете	Peso per scatola (Kg.) Weight x ctn. (Kg.) Poids x boîte (Kg.) Gew. x Kart. (Kg.) Peso por caja (Kg.) шт. вес коробки*	M ² per pallet Sq mts per pallet M ² par palette Qm. pro Palette M ² por palet M ² на палете	Peso per pallet (Kg.) Weight x pal. (Kg.) Poids x pal. (Kg.) Gew. x Pal. (Kg.) Peso por palet (Kg.) вес палета*
AIX	120x120	2	2,880	20	58,00	57,60	1.160,00
	75x150	1	1,130	35	23,68	39,38	828,80
	75x75	2	1,130	42	23,68	47,25	994,56
	37,5x75	4	1,130	48	23,68	54,00	1.136,64
	22,5x45,3	12	1,220	34	23,70	41,59	805,80
	22,5x22,5	20	1,013	42	19,40	42,53	814,80
	120x120 20mm	1	1,440	20	67,66	28,80	1.353,20
	60x90 20mm	2	1,080	18	48,50	19,44	873,00
	60x60 20mm	2	0,720	30	33,00	21,60	990,00
	22,5x45,4 20mm	5	0,510	40	20,43	20,40	817,20
	22,5x22,5 20mm	11	0,556	40	22,72	22,24	908,80
ARBOR	30x240	1	0,720	72	14,50	51,84	1.044,00
	15x90	10	1,350	36	26,67	48,60	960,12
ARKSHADE	7,5x60	22	0,990	60	19,10	59,40	1.146,00
	75x150	1	1,130	35	23,68	39,38	828,80
AXI	60x60	3	1,080	40	21,57	43,20	862,80
	30x60	7	1,260	40	24,85	50,40	994,00
BLAZE	22,5x90	6	1,220	36	25,20	43,74	907,20
	45x90 20mm	2	0,810	27	37,00	21,87	999,00
BOOST	60x60 20mm	2	0,720	30	33,00	21,60	990,00
	75x150	1	1,130	35	23,68	39,38	828,80
	75x75	2	1,130	42	23,68	47,25	994,56
	120x278	1	3,340	18	45,56	60,05	892,08
	120x120	2	2,880	20	58,00	57,60	1.160,00
	37,5x75	4	1,130	48	23,68	54,00	1.136,64
	120x120 20mm	1	1,440	20	67,66	28,80	1.353,20
	60x60 20mm	2	0,720	30	33,00	21,60	990,00
	160x320	1	5,120	14	72,00	71,68	1.008,00
	160x160	1	2,560	24	36,00	61,44	864,00
	120x278	1	3,340	18	49,56	60,05	892,08
BOOST PRO	120x240	1	2,880	18	58,00	51,84	1.044,00
	120x120	2	2,880	20	58,00	57,60	1.160,00
	120x120 6mm	2	2,880	20	40,32	57,60	806,40
	75x150	1	1,130	35	23,68	39,38	828,80
	75x75	2	1,130	42	23,68	47,25	994,56
	60x60	3	1,080	40	21,23	43,20	849,20
	30x60	7	1,260	40	24,85	50,40	994,00
	120x240 20mm	1	2,880	9	134,00	25,92	1.206,00
	120x120 20mm	1	1,440	20	67,66	28,80	1.353,20
	60x120 20mm	1	0,720	35	33,35	25,20	1.167,25
	90x90 20mm	1	0,810	18	37,60	14,58	676,80
BRAVE	60x60 20mm	2	0,720	30	33,00	21,60	990,00
	160x320	1	5,120	14	72,00	71,68	1.008,00
	160x160	1	2,560	24	36,00	61,44	864,00
	120x278	1	3,340	18	49,56	60,05	892,08
	120x240	1	2,880	18	58,00	51,84	1.044,00
	120x120	2	2,880	20	58,00	57,60	1.160,00
	120x120 6mm	2	2,880	20	40,32	57,60	806,40
	60x120	2	1,440	35	30,00	50,40	1.050,00
	75x150	1	1,130	35	23,68	39,38	828,80
	75x75	2	1,130	42	23,68	47,25	994,56
	37,5x75	4	1,130	48	23,68	54,00	1.136,64
DOLMEN PRO	60x60	3	1,080	40	21,23	43,20	849,20
	30x60	7	1,260	40	24,85	50,40	994,00
	120x120 20mm	1	1,440	20	67,66	28,80	1.353,20
	60x120 20mm	1	0,720	35	33,35	25,20	1.167,25
	90x90 20mm	1	0,810	18	37,60	14,58	676,80
	60x60 20mm	2	0,720	30	33,00	21,60	990,00
	75x150	1	1,130	35	23,68	39,38	828,80
	75x75	2	1,130	42	23,68	47,25	994,56
	45x90	3	1,220	36	24,50	43,74	882,00
	60x60	3	1,080	40	21,23	43,20	849,20
	30x60	7	1,260	40	24,85	50,40	994,00
MARVEL	120x120 20mm	1	1,440	20	67,66	28,80	1.353,20
	60x120 20mm	1	0,720	35	33,35	25,20	1.167,25
	90x90 20mm	1	0,810	18	37,60	14,58	676,80
	60x60 20mm	2	0,720	30	33,00	21,60	990,00
	75x150	1	1,130	35	23,68	39,38	828,80
	75x75	2	1,130	42	23,68	47,25	994,56
	45x90	3	1,220	36	24,50	43,74	882,00
	60x60	3	1,080	40	21,23	43,20	849,20
	30x60	7	1,260	40	24,85	50,40	994,00
	120x120 20mm	1	1,440	20	67,66	28,80	1.353,20
	60x120 20mm	1	0,720	35	33,35	25,20	1.167,25
DOLMEN PRO	45x90 20mm	2	0,810	27	37,00	21,87	999,00
	60x60 20mm	2	0,720	30	33,00	21,60	990,00
	30x60 20mm	3	0,540	40	24,00	21,60	960,00
	75x150	1	1,130	35	23,68	39,38	828,80
	75x75	2	1,130	42	23,68	47,25	994,56
	37,5x75	4	1,130	48	23,68	54,00	1.136,64
	22,5x45,3	12	1,220	34	23,70	41,59	805,80
	22,5x22,5	20	1,010	42	19,40	42,53	814,80
	60x120 20mm	1	0,720	35	33,35	25,20	1.167,25
	22,5x45,4 20mm	5	0,510	40	20,43	20,40	817,20
	22,5x22,5 20mm	11	0,556	40	22,72	22,24	908,80

DWELL	75x150	1	1,130	35	23,68	39,38	828,80
	75x75	2	1,130	42	23,68	47,25	994,56
	60x60	3	1,080	40	21,23	43,20	849,20
	30x60	7	1,260	40	24,85	50,40	994,00
ETIC	120x120	2	2,880	20	58,00	57,60	1.160,00
	90x90 20mm	1	0,810	18	37,60	14,58	676,80
	22,5x90	6	1,220	36	25,20	43,74	907,20
	15x90	9	1,220	36	26,60	43,74	957,60
ETIC PRO	11x90	12	1,190	36	25,50	42,77	918,00
	25x150	3	1,130	30	23,68	33,75	710,00
	22,5x90	6	1,220	36	25,20	43,74	907,20
	15x90	10	1,350	36	28,00	48,60	1.118,00
EXENCE	30x120 20mm	2	0,720	36	33,00	25,92	528,00
	18,5x150	4	1,110	40	23,68	44,40	947,20
GRANIGLIATI	20x120	6	1,440	42	31,10	60,48	1.306,20
	30x120 20mm	2	0,720	36	33,00	25,92	1.188,00
GREENCOLORS	30x30	12	1,080	48	20,10	51,84	964,80
	20x20	18	0,720	60	19,80	43,20	1.188,00
GROUND TRACK	20x20	36	1,440	56	23,18	80,64	1.298,08
	30x30	12	1,080	30	22,00	32,40	660,00
HEARTWOOD	18,5x150	4	1,110	40	23,68	44,40	947,20
	20x120	6	1,440	42	31,10	60,48	1.306,20
KLIF	75x150	1	1,130	35	23,68	39,38	828,80
	75x75	2	1,130	42	23,68	47,25	994,56
	37,5x75	4	1,125	48	25,00	54,00	1.200,00
	90x90 20mm	1	0,810	18	37,60	14,58	676,80
KONE	45x90 20mm	2	0,810	27	37,00	21,87	999,00
	60x60 20mm	2	0,720	30	33,00	21,60	990,00
	75x150	1	1,130	35	23,68	39,38	828,80
	75x75	2	1,130	42	23,68	47,25	994,56
LIMS	60x60	3	1,080	40	21,23	43,20	849,20
	30x60	7	1,260	40	24,85	50,40	994,00
	120x240	1	2,880	18	58,00	51,84	1.044,00
	120x120	2	2,880	20	58,00	57,60	1.160,00
MARK	60x60 20mm	2	0,720	30	33,00	21,60	990,00
	120x278	1	3,340	18	49,56	60,05	892,08
	120x120	2	2,880	20	58,00	57,60	1.160,00
	75x150	1	1,130	35	23,68	39,38	828,80
MARVEL	75x75	2	1,130	42	23,68	47,25	994,56
	37,5x75	4	1,130	48	25,00	54,00	1.200,00
	60x120 20mm	1	0,720	35	33,35	25,20	1.167,25
	60x60 20mm	2	0,720	30	33,00	21,60	990,00
MARVEL DREAM	60x60	3	1,080	40	21,23	43,20	849,20
	30x60	7	1,260	40	24,85	50,40	994,00
	120x278	1	3,340	18	49,56	60,05	892,08
	120x240	1	2,880	18	58,00	51,84	1.044,00
MARVEL EDGE	120x120	2	2,880	20	58,00	57,60	1.160,00
	60x120	2	1,440	35	30,00	50,40	1.050,00
	75x150	1	1,130	35	23,68	39,38	828,80
	75x75	2	1,130	42	23,68	47,25	994,56
MARVEL GEMS	45x90	3	1,220	36	24,60	43,74	885,60
	60x60	3	1,080	40	21,23	43,20	849,20
	30x60	7	1,260	40	24,85	50,40	994,00
	60x60	3	1,080	40	21,23	43,20	849,20
MARVEL PRO	160x320	1	5,120	14	72,00	71,68	1.008,00
	160x160	1	2,560	24	36,00	61,44	864,00
	120x278	1	3,340	18	49,56	60,05	892,08
	120x240	1	2,880	18	58,00	51,84	1.044,00
MARVEL PRO	120x120	2	2,880	20	58,00	57,60	1.160,00
	60x120	2	1,440	35	30,00	50,40	1.050,00
	75x150	1	1,130	35	23,68	39,38	828,80
	75x75	2	1,130	42	23,68	47,25	994,56
MARVEL PRO	45x90	3	1,220	36	24,60	43,74	885,60
	60x60	3	1,080	40	21,23	43,20	849,20
	30x60	7	1,260	40	24,85	50,40	994,00
	60x60	3	1,080	40	21,23	43,20	849,20

* +/- 10%
The reported values do not include the weight of pallets.
I valori riportati non comprendono il peso dei pallet.

Serie Série Série Série Série Серия	Formato Size Format Format Formato Размер	Pezzi per scatola Pieces per carton Pièces par boîte Stückzahl x Kart. Piezas por caja шт. в коробке	M² per scatola Sq mts per carton M² par boîte Qm. pro Karton M² por caja M² в коробке	Box per pallet Box per pallet Boîtes per palette Karton pro Palette Cajas por palet Коробок на палете	Peso per scatola (Kg.) [*] Weight x ctn. (Kg.) [*] Poids x boîte (Kg.) [*] Gew. x Kart. (Kg.) [*] Peso por caja (Kg.) [*] шт. вес коробки*	M² per pallet Sq mts per pallet M² par palette Qm. pro Palette M² por palet M² на палете	Peso per pallet (Kg.) [*] Weight x pal. (Kg.) [*] Poids x pal. (Kg.) [*] Gew. x Pal. (Kg.) [*] Peso por palet (Kg.) [*] вес малета*
MARVEL SHINE	160x320	1	5,120	14	72,00	71,68	1.008,00
	160x160	1	2,560	24	36,00	61,44	864,00
	120x278	1	3,340	18	49,56	60,05	892,08
	120x240	1	2,880	18	58,00	51,84	1.044,00
	120x120	2	2,880	20	58,00	57,60	1.160,00
	60x120	2	1,440	35	30,00	50,40	1.050,00
	75x150	1	1,130	35	23,68	39,38	828,80
	75x75	2	1,130	42	23,68	47,38	994,56
	37,5x75	4	1,130	48	23,68	54,00	1.136,64
	60x60	3	1,080	40	21,23	43,20	849,20
30x60	7	1,260	40	24,85	50,40	994,00	
MARVEL STONE	160x320	1	5,120	14	72,00	71,68	1.008,00
	160x160	1	2,560	24	36,00	61,44	864,00
	120x278	1	3,340	18	49,56	60,05	892,08
	120x240	1	2,880	18	58,00	51,84	1.044,00
	120x120	2	2,880	20	58,00	57,60	1.160,00
	60x120	2	1,440	35	30,00	50,40	1.050,00
	75x150	1	1,130	35	23,68	39,38	828,80
	75x75	2	1,130	42	23,68	47,25	994,56
	45x90	3	1,220	36	24,60	43,74	885,60
	60x60	3	1,080	40	21,23	43,20	849,20
30x60	7	1,260	40	24,85	50,40	994,00	
60x120 20mm	1	0,720	35	33,35	25,20	1.167,25	
MEK	75x150	1	1,130	35	23,68	39,38	828,80
	45x90	3	1,220	36	24,60	43,74	885,60
	60x60	3	1,080	40	21,23	43,20	849,20
	30x60	7	1,260	40	24,85	50,40	994,00
NASH	20x120	6	1,440	36	31,10	51,84	1.119,60
	7,5x60	22	0,990	60	19,10	59,40	1.146,00
NID	25x150	3	1,125	30	25,00	33,75	750,00
	18,5x150	4	1,110	40	23,68	44,40	947,20
	15x90	10	1,350	36	26,67	48,60	960,12
NORDE	60x120	2	1,440	35	30,00	50,40	1.050,00
	60x60	3	1,080	40	21,23	43,20	849,20
	30x60	7	1,260	40	24,85	50,40	994,00
	60x120 20mm	1	0,720	35	33,35	25,20	1.167,25
	60x90 20mm	2	1,080	18	48,50	19,44	873,00
PRISM	120x278	1	3,340	18	49,56	60,05	892,08
	120x120	2	2,880	20	58,00	57,60	1.160,00
	60x120	2	1,440	35	30,00	50,40	1.050,00
	60x60	3	1,080	40	21,23	43,20	849,20
	30x60	7	1,260	40	24,85	50,40	994,00
120x120 20mm	1	1,440	20	67,66	28,80	1.353,20	
RAW	120x278	1	3,340	18	49,56	60,05	892,08
	120x120	2	2,880	20	58,00	57,60	1.160,00
	75x150	1	1,130	35	23,68	39,38	828,80
	75x75	2	1,130	42	23,68	47,25	994,56
	37,5x75	4	1,130	48	23,68	54,00	1.136,64
	60x60	3	1,080	40	21,23	43,20	849,20
	30x60	7	1,260	40	24,85	50,40	994,00
	120x120 20mm	1	1,440	20	67,66	28,80	1.353,20
60x120 20mm	1	0,720	35	33,35	25,20	1.167,25	
SEASTONE	60x60	3	1,080	40	21,23	43,20	849,20
	30x60	7	1,260	40	24,85	50,40	994,00
	60x60 20mm	2	0,720	30	33,00	21,60	990,00
	45x90	3	1,220	36	24,60	43,74	885,60
TRUST	22,5x90	6	1,220	36	25,20	43,74	907,20
	60x60	3	1,080	40	21,23	43,20	849,20
	40x60	4	0,960	60	19,84	57,60	1.190,40
	30x60	7	1,260	40	24,85	50,40	994,00
	20x60	7	0,840	72	17,22	60,48	1.239,84
	30x30	11	0,990	48	20,26	47,52	972,48
	60x120 20mm	1	0,720	35	33,35	25,20	1.167,25
	45x90 20mm	2	0,810	27	37,00	21,87	999,00
	60x60 20mm	2	0,720	30	33,00	21,60	990,00
	30x60 20mm	3	0,540	40	24,00	21,60	960,00
	60x60 30mm	2	0,720	30	33,00	21,60	999,20
VENTI BOOST	20x20	30	1,200	56	23,90	67,20	1.338,40

Serie Série Série Série Série Серия	Formato Size Format Format Formato Размер	Pezzi per scatola Pieces per carton Pièces par boîte Stückzahl x Kart. Piezas por caja шт. в коробке	M² per scatola Sq mts per carton M² par boîte Qm. pro Karton M² por caja M² в коробке	Box per pallet Box per pallet Boîtes per palette Karton pro Palette Cajas por palet Коробок на палете	Peso per scatola (Kg.) [*] Weight x ctn. (Kg.) [*] Poids x boîte (Kg.) [*] Gew. x Kart. (Kg.) [*] Peso por caja (Kg.) [*] шт. вес коробки*	M² per pallet Sq mts per pallet M² par palette Qm. pro Palette M² por palet M² на палете	Peso per pallet (Kg.) [*] Weight x pal. (Kg.) [*] Poids x pal. (Kg.) [*] Gew. x Pal. (Kg.) [*] Peso por palet (Kg.) [*] вес малета*	
3D WALL DESIGN	3D Line 50x120	3	1,800	30	30,43	54,00	913,00	
	3D Flows 50x120	3	1,800	30	30,43	54,00	913,00	
	3D Ultra Blade 50x120 Matt	3	1,800	30	30,43	54,00	913,00	
	3D Flake 40x80	4	1,280	48	20,35	61,44	977,00	
	3D Twist 40x80	4	1,280	48	19,98	61,44	959,00	
	3D Flash 40x80	4	1,280	48	20,19	61,44	969,00	
	3D Diamond 40x80	4	1,280	48	20,50	61,44	977,00	
	3D Blade 40x80	4	1,280	48	20,23	61,44	971,00	
	3D Stars 40x80	4	1,280	48	20,85	61,44	1.001,00	
	3D Angle 40x80	4	1,280	48	21,02	61,44	1.009,00	
	3D Mesh 40x80	4	1,280	48	20,60	61,44	989,00	
	3D Wind 40x80	4	1,280	48	21,04	61,44	1.010,00	
	3D Dune 40x80	4	1,280	48	20,42	61,44	980,00	
	3D Wave 40x80	4	1,280	48	20,98	61,44	1.007,00	
	3D Ribbon 40x80	4	1,280	48	20,23	61,44	971,00	
	3D Line 30,5x56	8	1,370	32	21,84	43,72	699,00	
	3D Wave 30,5x56	8	1,370	32	21,59	43,72	665,00	
AIX Wall	3D Ultra 30,5x56	8	1,370	32	20,78	43,72	725,76	
	Solid 50x120	3	1,800	35	27,17	63,00	951,00	
	Solid 40x80	4	1,280	54	14,80	69,12	799,00	
	Solid 30,5x56	9	1,540	32	22,56	49,19	722,00	
	40x80	4	1,280	54	18,59	69,12	1.004,00	
	3D Row 40x80	4	1,280	48	21,15	61,44	1.015,00	
	ARKSHADE Wall	Solid 40x80	4	1,280	54	19,30	69,12	1.042,00
		40x80	4	1,280	54	19,30	69,12	1.042,00
		3D Stars 40x80	4	1,280	48	19,42	61,44	932,00
	ARTY Wall	40x80	4	1,280	54	18,33	69,12	990,00
		3D Wave 40x80	4	1,280	48	21,06	61,44	1.011,00
	BLAZE Wall	50x120	3	1,800	35	24,00	63,00	840,00
	BOOST Wall	40x80	4	1,280	54	17,35	69,12	937,00
		3D Urban 40x80	4	1,280	48	19,85	61,44	953,00
	BOOST PRO Wall	40x80	4	1,280	54	17,37	69,12	938,00
		3D Urban 40x80	4	1,280	48	20,73	61,44	995,00
	BRAVE Wall	40x80	4	1,280	54	19,30	69,12	1.042,00
3D Wave 40x80		4	1,280	48	21,75	61,44	1.044,00	
3D Blade 40x80	4	1,280	48	19,94	61,44	957,00		
	BRICK Wall	8x31,5	19	0,500	84	7,71	42,34	648,00
8x31,5	20	0,500	84	7,71	42,34	662,00		
	DWELL Wall	40x80	4	1,280	54	19,00	69,12	1.026,00
40x80	4	1,280	54	17,39	69,12	939,00		
	EWALL Wall	40x80	4	1,280	54	18,16	69,12	980,64
40x80	4	1,280	54	18,87	69,12	1.019,00		
	KLIF Wall	3D Row 40x80	4	1,280	48	19,02	61,44	913,00
LIMS Wall	40x80	4	1,280	54	19,57	69,12	1.057,00	
	3D Wallpaper 40x80	4	1,280	54	17,63	69,12	952,00	
	3D Way 40x80	4	1,280	54	17,63	69,12	952,00	
MARVEL Wall	50x120	3	1,800	35	27,34	63,00	957,00	
	30,5x91,5	5	1,400	42	21,83	58,59	917,00	
	40x80	4	1,280	54	18,00	69,12	972,00	
MARVEL DREAM Wall	30,5x56	9	1,540	32	22,81	49,19	730,00	
	50x120	3	1,800	35	27,34	63,00	957,00	
MARVEL EDGE Wall	50x120	3	1,800	35	26,43	63,00	925,00	
	40x80	4	1,280	54	18,91	69,12	1.021,00	
MARVEL PRO Wall	50x120	3	1,800	35	27,34	63,00	957,00	
	30,5x91,5	5	1,400	42	19,40	58,59	815,00	
	40x80	4	1,280	54	18,17	69,12	981,00	
MARVEL SHINE Wall	50x120	3	1,800	35	26,26	63,00	919,00	
	40x80	4	1,280	54	19,20	69,12	1.037,00	
MARVEL STONE Wall	50x120	3	1,800	35	27,34	63,00	957,00	
	40x80	4	1,280	54	17,35	69,12	937,00	
MEK Wall	50x120	3	1,800	35	27,11	63,00	949,00	
	3D Fold 50x120	3	1,800	30	30,97	54,00	929,00	
	3D Ultra Blade 50x120	3	1,800	30	30,43	54,00	913,00	
PRISM Wall	50x120	3	1,800	35	26,09	63,00	913,00	
	50x120	3	1,800	35	27,86	63,00	975,00	
RAW Wall	50x120	3	1,800	35	27,86	63,00	975,00	
	3D Scratch 50x120	3	1,800	30	31,57	54,00	947,00	

* +/- 10%
The reported values do not include the weight of pallets.
I valori riportati non comprendono il peso dei pallet.

February 2021
February 2021
Reported data can be subject to variations throughout the year, present values are updated on the date of catalogue printing.
I dati riportati possono subire delle variazioni nel corso dell'anno, i valori sono aggiornati al mese di stampa.

General sales conditions

A.- CONTRACT COMPLETION

A.1. These general sales conditions govern every sales contract between the Seller and the Buyer and any amendment or exception thereof shall be agreed in writing.

A.2. Any offers, credits and/or rebates granted by agents or other intermediaries, shall not be considered valid if they are not confirmed in writing by the Seller.

A.3.- The Buyer shall send the written orders to the Seller, directly or through the agents, and the orders shall include the codes of the required products, quantity, price and destination. The order sent by the Buyer is irrevocable.

A.4. The sale shall be deemed completed when: (i) the Buyer receives a written confirmation from the Seller, via e-mail, fax or other electronic means, that complies with the terms and conditions of the order; or (ii) if the confirmation sent by the Seller contains conditions that differ from the order sent by the Buyer, when the latter accepts it in writing or in any case does not object within 7 (seven) days from reception; or (iii) if the Seller does not provide a written confirmation, when the products are delivered and loaded by the Buyer.

A.5. The Buyer shares the need to restrict the sales of Atlas Concorde products to the national territory. The Seller deems this rule necessary in order to coordinate its sales policy, streamline its distribution network and provide offers that are suited to the needs of the single countries. The Buyer acknowledges that this rule is also in its best interest. The Buyer therefore undertakes to market the products supplied by Ceramiche Atlas Concorde SpA exclusively in its country of residence, refraining from promoting active sales, even online, with customers located in the territory of a country different from its own. As regards triangular operations, this undertaking applies to the country in which the buyer actually operates. The Buyer may resell the product outside its territory only with written authorisation from the Seller, or if the sales concern non first-grade products or products that are out of production.

B.- PRICES

B.1. The prices agreed upon for each individual sale are net prices for cash delivery ex works (the Seller's plant shall be specified in the order confirmation), unless otherwise agreed in writing.

C.- PRODUCT CHARACTERISTICS

C.1. The Buyer declares to have read and comply with the content of the following documentation published on the corporate website: 1) Laying, use, cleaning and maintenance manual and 2) Technical data sheets.

C.2. Given the intrinsic variability of the ceramic products, the characteristics of the samples, previously sent by the Seller to the Buyer, are purely illustrative and cannot be deemed binding.

C.3. Unless specifically requested and agreed before the order confirmation, the Seller does not guarantee that the entire quantity of an article on order shall be sent from one same production lot.

D.- DELIVERY TERMS

D.1. The delivery terms are understood to be indicative and the extension thereof cannot entitle the Purchaser to request any form of compensation, without exception.

D.2. If, after 14 (fourteen) days from the date of notification that the goods are ready, the Purchaser fails to collect them, the Seller shall be forced for reasons of occupied space to return the goods to the storage facilities, thereby incurring additional costs; the Seller reserves the right to charge the Purchaser such additional costs.

E.- SHIPPING ARRANGEMENTS AND TERMS

E.1. The Buyer must communicate any variation in the destination of the products, different from the one agreed in the order confirmation, in writing within, and no later than, the second day before the day foreseen for the collection at the Seller's premises. The Seller reserves the right not to accept the change of the product destination. If the actual destination of the product is different from the one stated by the Buyer, the Seller reserves the right to suspend the execution of the supplies underway and/or to terminate the contracts in force and the Buyer shall not have the right to claim direct and/or indirect compensation of any type.

E.2. Unless otherwise agreed, the goods shall be delivered ex-works (EXW - Incoterms 2010) and this shall also be the case when the parties agree that the delivery, or part of it, shall be arranged by the Seller on the Buyer's behalf. In any case, the risks shall transfer to the Buyer upon delivery to the first carrier.

E.3. Without prejudice to the Seller's extraneity in relation to the transport contract, the Seller shall not be indicated as "shipper" on the bill of lading. The communication

of the gross weight of the container to the Forwarding agent does not represent in any way the undertaking of any liability by the Seller as regards the SOLAS (Safety Of Life At Sea) Convention. In no event may the said communication be taken to be the VGM (Verified Gross Mass).

E.4. The Buyer undertakes to ensure that the vehicle sent to the Seller's warehouse is suitable for the loading operations, considering the nature of the products. If the vehicle sent to collect the goods causes difficulties in the loading operations, the Seller reserves the right to charge a penalty, of 4% of the value of the products, to cover the extra logistics costs. If the vehicle sent is not at all suitable, the Seller reserves the right to refuse to load the goods and the Buyer shall not have the right to claim compensation for any direct and/or indirect cost that may arise therefrom.

E.5. The Buyer is responsible for assigning the carrier the task of checking the products before loading them; any observations concerning the condition of the packaging and the correspondence of the quantities loaded with those on the transport document must be made by the carrier upon collection of the goods. The said observations must be written on all the copies of the transport documents, otherwise the loaded products shall be considered to be complete and in good condition. As a result, the Seller shall not be liable for any missing or damaged products not reported by the carrier.

E.6. The Buyer is also responsible for assigning the carrier the task of checking the loading procedure and the stability of the goods on the vehicle, in order to prevent damage during transport and to comply with all road safety provisions.

F.- PAYMENTS

F.1. All payments must be made to the Seller's registered office. Payments made to agents, representatives, or sales assistants shall not be considered as made until the amounts are received by the Seller.

F.2. The Buyer shall not fulfil its payment obligations by making payments from countries other than its own country of residence, if the said countries do not guarantee an adequate exchange of information with Italy. In case of breach of the said prohibition, the Seller has the right to terminate the contract for just cause and the Buyer shall not have the right to claim compensation for any damage suffered.

F.3. Any costs for stamp duty and bank draft fees shall be borne by the Buyer. Failure to fulfil, even only in part, the payment shall result in the application of interest on arrears in favour of the Seller, from the date established for the payment, as envisaged by legislative decree 09/10/2002 no. 231.

F.4. Unless otherwise agreed in writing, the Buyer undertakes not to offset any receivables, of whatever nature, owed by the Seller.

G.- CLAIMS

G.1. Upon receipt of the products, the Buyer shall perform a visual inspection in compliance with instructions provided in point 7 of UNI EN ISO 10545-2 standards.

G.2. The products must be installed and fitted strictly respecting the recommendations related to the activities to be performed before and during the laying of the product specified in document 1) Laying, use, cleaning and maintenance manual, published on the Seller's website, and on the product packaging and/or inside the packaging. Faults caused by an incorrect installation and by missing/incorrect maintenance (different from instructions provided in document 1) Laying, use, cleaning and maintenance manual), by an unsuitable use and/or by normal wear over time shall not be considered product faults.

G.3. With the exception of the limits of acceptability foreseen by the international EN 14411 (ISO 13006) standard, the parties acknowledge as identifiable faults those product defects that are immediately visible upon receipt thereof and that make the material unsuitable for use or that significantly reduce its value. This category includes faults as defined in the document 1) Laying, use, cleaning and maintenance manual, published on the Seller's website. Identifiable faults include, by way of a non-limiting example, superficial defects, decoration defects, defects concerning polishing, dimensions, surface flatness, straightness of sides/rectangularity and thickness, cracks, chippings or rough edges, non-compliant shades, mixed shades and products that feature problems deriving from the cutting process and/or from chips.

G.4. If the Buyer finds an identifiable fault, it must be reported in writing to the Seller, within 8 (eight) days from receipt of the products; failure to send the claim shall result in the forfeiture and loss of such right. The Buyer shall keep the entire lot of material readily available for the Seller. The claim shall include the invoice details and an accurate description of the claimed fault together with photographs, where possible.

In the event that the claim proves to be unfounded, the Buyer shall refund the Seller any costs incurred for an inspection (expert's reports, travel, etc.).

G.5. Hidden faults shall be notified to the Supplier in writing, by recorded delivery letter with advice of receipt, within 8 days from the date such fault is found, under penalty of forfeiture.

G.6. The Buyer's right to make a claim for faults under warranty is valid for 12 (twelve) months from the delivery of the products.

H.- WARRANTY FOR FAULTS

H.1. The Seller's warranty is limited to first grade products and not second or third grade products or lots on offer with special prices or discounts, which must be duly specified with a note in the order confirmation.

H.2. The Seller does not guarantee the suitability of the products for particular uses, and only guarantees the technical specifications published on the website in the document 2) Technical data sheets. The indication for use is merely indicative, even when written in the Seller's catalogues and manuals. On the basis of the characteristics described in the document 2) Technical data sheets, the designer always has the task of assessing the suitability of the product for the specific use conditions, taking into account the stress and variables to which the product will be subjected, which may alter its characteristics; for example, the traffic intensity, quality of traffic (foot traffic with the presence of sand, debris...), adverse weather conditions and any other unpredictable factor to which the material may be exposed.

H.3. In the event that identifiable product faults are ascertained, as defined in sub section G no. 3, the Seller shall replace the faulty product with another one with equal or superior characteristics; should this not be possible, the Seller shall apply a significant price reduction. Alternatively, following the return of the faulty products, the Buyer shall have the right to a refund of the price paid plus the transport cost, with the exclusion of compensation for any other direct and/or indirect damage.

H.4. The Seller's warranty shall not be valid if the products that have identifiable faults (totally or in part) have been used and/or in any case transformed, as this entails that the Buyer (or its customer) expressed the intention to accept them in the condition in which they were found.

H.5. In the event that hidden product faults are ascertained, the Seller's warranty is limited to the replacement with other products of equal or superior characteristics; should this not be possible the Seller shall refund the price paid plus the transport cost. In any case, the Seller's warranty for any direct and/or indirect damage caused by the faulty product, shall be limited to an amount that shall not be greater than double the selling price applied by the Seller, only in relation to the faulty part of the supply.

H.6. In the event that the Buyer resells the product to subjects protected by the consumer code (law decree no. 206/2005), the former shall be responsible for the conditions applied, if different from those stated herein, and shall ensure that the consumer's rights are exercised, in relation to the remedies and terms established by the said code. If there are the grounds for the Buyer to exercise the right of recourse and/or make a claim against the Seller/manufacturer, the said action shall take into account or go beyond the exemptions and limits established in sub sections G no. 1 and H no. 5.

I. SOLVE ET REPETE (pay and then claim) AND TERMINATION CLAUSES

I.1. Pursuant to article 1462 of the Italian Civil Code, on no account may the Buyer suspend or delay payment of collected material, including in the event of alleged defects or faults in the material; this does not affect the right to claim back any payments made unduly (solve et repete).

I.2. If the Buyer's financial situation changes or in the event of non-payment (even partial) of products already supplied, the Seller reserves the right to suspend the execution of the supplies underway and/or to terminate the contracts in force and the Buyer shall not have the right to claim direct and/or indirect compensation of any type.

L.- RETENTION OF OWNERSHIP

L.1. The products supplied shall remain exclusive property of the Seller until the Buyer has paid the full amount.

L.2. During the aforementioned period, the Buyer shall undertake the obligations and responsibilities as bailee (also referred to as custodian) and shall not transfer the said products, grant their use, let them be seized or distrained without declaring that the property is of the Seller, and the Buyer shall immediately inform the Seller by recorded delivery letter with advice of receipt.

M.- FORCE MAJEURE

M.1. Each party may suspend the fulfilment of its contractual obligations, when the said fulfilment is impossible or objectively too costly due to an unforeseeable impediment independent from the parties, such as for example: strike, boycott, lockout, fire, war (declared or not), civil war, riots and revolutions, requisitions, embargo, power blackouts, extraordinary breakage of machinery, delays in the delivery of components or raw materials.

M.2. The party that wishes to apply this clause shall immediately notify the onset and end of the circumstances of force majeure to the other party in writing.

M.3. If the suspension due to force majeure lasts longer than 60 (sixty) days, each party shall have the right to terminate this contract, with a notice of 10 (ten) days to be notified to the counterparty in writing.

N.- CONFIDENTIALITY

N.1. The Buyer undertakes to maintain confidentiality as regards all information of a technical (such as, by way of a non-limiting example, drawings, tables, documentation, formulas and correspondence) and commercial nature (including contractual conditions, purchase prices, payment conditions,...) gained during the performance of this contract.

N.2. The confidentiality obligation shall be undertaken for the entire duration of this contract and for the period following its execution.

N.3. In case of failure to uphold the confidentiality obligation, the non-fulfilling party shall pay the other party compensation for all damages that may derive therefrom.

O.- SELLER'S TRADEMARKS AND DISTINCTIVE SIGNS

O.1. The use of trademarks, ornamental designs and creative works in general, in whatever form and manner of expression (such as, by way of a non-limiting example: images, photos, drawings, videos, shapes, structures, etc.) constituting the Seller's intellectual property, through any means (such as, by way of a non-limiting example: press, video, radio, internet, social media, instant messaging platforms or VoIP, etc.) is strictly forbidden. Any exception to the said prohibition, even only partial, must be authorised in writing, each time, by the Seller's general management.

P.- CONTRACT LANGUAGE, APPLICABLE LAW, JURISDICTION AND AUTHORITY

P.1. The present contract is drafted in Italian, and in case of disputes the said version shall prevail over any translations in other languages.

P.2. Any dispute concerning the supply of products shall be subject to Italian law and jurisdiction and the Court of Modena, the town in which the Seller has its registered office, shall have sole local jurisdiction.

For more information refer to the General Conditions of Sale, available at www.atlasconcorde.com

Condizioni generali di vendita

A.- MODALITA' DI CONCLUSIONE DEL CONTRATTO

A.1. Le presenti Condizioni Generali di Vendita disciplinano ogni contratto di Vendita tra il Venditore e l'Acquirente ed ogni loro modifica o deroga deve essere concordata per iscritto.

A.2. Eventuali offerte, accrediti e/o abbuoni accordati da agenti o da altri intermediari, non sono ritenuti validi se non confermati per iscritto dal Venditore.

A.3. L'Acquirente invia al Venditore, direttamente o per il tramite di agenti, Ordini scritti che devono contenere l'indicazione dei codici dei Prodotti richiesti, delle quantità, del loro prezzo e della destinazione. L'Ordine inviato dall'Acquirente è irrevocabile.

A.4. La Vendita dovrà ritenersi conclusa nel momento in cui: (i) l'Acquirente riceva da parte del Venditore una Conferma scritta via e-mail, fax o altri mezzi telematici, conforme ai termini e alle condizioni dell'Ordine; o (ii) in caso di Conferma inviata dal Venditore contenente condizioni difformi dall'Ordine ricevuto dall'Acquirente quando questi l'accetti per iscritto o comunque non la contesti entro 7 (sette) giorni dalla ricezione; o (iii) in assenza di conferma scritta da parte del Venditore, nel momento in cui i Prodotti saranno consegnati e caricati dall'Acquirente.

A.5. L'Acquirente condivide l'esigenza di limitare al territorio nazionale le vendite di prodotti Atlas Concorde. Il Venditore ritiene questa regola elemento indispensabile per permettergli di coordinare la sua politica commerciale e razionalizzare la rete distributiva, con offerte più orientate alle necessità dei singoli Paesi. Parimenti, l'Acquirente riconosce che tale esigenza costituisce una tutela anche dei propri interessi.

L'Acquirente si obbliga quindi a commercializzare i prodotti forniti da Ceramiche Atlas Concorde SpA esclusivamente nel suo Paese di residenza, astenendosi dal promuovere vendite attive sollecitate anche online con clienti situati nel territorio di uno Stato diverso dal proprio. Per le operazioni triangolari il presente obbligo si applica al Paese di effettiva operatività dell'acquirente. L'Acquirente potrà rivendere il prodotto al di fuori dal proprio territorio nel caso in cui riceva autorizzazione per iscritto da parte del Venditore, o nel caso in cui la rivendita riguardi prodotti non di prima scelta, oppure prodotti fuori produzione.

B.- PREZZI

B.1. Salvo diversa pattuizione scritta, i prezzi di vendita concordati di volta in volta si intendono al netto per contanti e per consegna franco stabilimento del Venditore indicato nella Conferma d'Ordine.

C.- CARATTERISTICHE DEI PRODOTTI

C.1. L'Acquirente dichiara di aver preso visione ed attenersi al contenuto della seguente documentazione pubblicata nel sito internet aziendale: 1) Manuale di Posa, Uso, Pulizia e Manutenzione e 2) Schede tecniche.

C.2. Data la intrinseca variabilità del prodotto ceramico, le caratteristiche dei campioni e/o modelli inviati in precedenza dal Venditore all'Acquirente sono da considerarsi indicativi e non vincolanti.

C.3. Salvo specifiche richieste da concordare prima della Conferma d'Ordine, il Venditore non garantisce che l'ordine del singolo articolo venga evaso tutto con un medesimo lotto di produzione.

D.- TERMINI DI CONSEGNA

D.1. I termini di consegna sono da intendersi indicativi e la proroga di essi non può far maturare all'Acquirente alcun diritto a richiedere indennizzi, ogni eccezione rimossa.

D.2. Se, trascorsi 14 (quattordici) giorni dalla data di avviso di merce pronta, l'Acquirente non ritira il materiale, il Venditore sarà costretto per ragioni di spazio occupato a riportare il materiale nelle locazioni di deposito, sostenendo quindi costi supplementari; il Venditore si riserva la possibilità di addebitare tali costi supplementari all'Acquirente.

E.- RESA E SPEDIZIONE

E.1. L'eventuale variazione della destinazione dei Prodotti, diversa da quella concordata in Conferma d'Ordine, deve essere comunicata dall'Acquirente per iscritto entro e non oltre il secondo giorno antecedente a quello previsto per il ritiro presso la sede del Venditore. Il Venditore si riserva la facoltà di non accettare la variazione della destinazione dei Prodotti. Nel caso si verifichi che la destinazione effettiva del Prodotto sia stata diversa da quella dichiarata dall'Acquirente, il Venditore si riserva la facoltà di sospendere l'esecuzione delle forniture in corso e/o risolvere i contratti in corso senza che l'Acquirente possa rivendicare risarcimenti diretti e/o indiretti di alcun tipo.

E.2. Salvo patto contrario, la fornitura della merce si intende Franco Fabbrica (EXW ai sensi degli Incoterms 2010) e ciò anche quando sia convenuto che la spedizione o parte di essa venga curata dal Venditore su mandato dell'Acquirente. In ogni caso i rischi passano all'Acquirente al più tardi con la consegna al primo trasportatore.

E.3. Ferma restando l'estraneità del Venditore rispetto al contratto di trasporto, il Venditore non potrà essere indicato come "shipper" nella polizza di carico. La comunicazione del peso lordo del container allo spedizioniere, non costituisce alcuna assunzione di responsabilità da parte del Venditore ai fini della Convenzione SOLAS (Safety Of Life At Sea). In nessun caso tale comunicazione potrà essere intesa come VGM (Verified Gross Mass).

E.4. L'Acquirente s'impegna affinché il mezzo inviato presso i magazzini del Venditore sia idoneo al carico in relazione alla natura dei Prodotti. Nel caso il mezzo che si presenta comporti significative difficoltà per le operazioni di carico, il Venditore si riserva di addebitare una penale pari al 4% del valore dei prodotti a copertura dei maggiori costi logistici. Se il mezzo convenuto non è assolutamente idoneo, il Venditore si riserva la facoltà di negare le operazioni di carico senza che nulla possa essere richiesto dall'Acquirente a titolo di risarcimento per ogni onere diretto e/o indiretto che ne possa derivarne.

E.5. È compito dell'Acquirente incaricare il vettore di controllare i prodotti prima del carico; eventuali osservazioni in relazione all'integrità degli imballi e della rispondenza delle quantità caricate a quelle indicate sul documento di trasporto, devono essere sollevate dal vettore al momento del carico. Tali osservazioni devono essere riportate su tutte le copie dei documenti di trasporto, altrimenti i prodotti caricati s'intendono integri e completi. Ne deriva che il Venditore non si assume alcuna responsabilità in relazione a mancanze o danni dei prodotti non segnalati dal vettore.

E.6. È altresì responsabilità dell'Acquirente incaricare il vettore di verificare le modalità e la stabilità del carico sul mezzo affinché durante il trasporto non si verifichino rotture e affinché siano rispettate tutte le disposizioni di sicurezza riguardanti la circolazione stradale.

F.- PAGAMENTI

F.1. Qualsiasi obbligazione di pagamento deve essere adempiuta presso la sede legale del Venditore. Eventuali pagamenti ad agenti, rappresentanti o ausiliari di commercio non si intendono effettuati finché le relative somme non pervengono al Venditore.

F.2. È fatto divieto all'Acquirente di eseguire il proprio adempimento mediante pagamenti provenienti da paesi diversi dal proprio paese di residenza se trattasi di paesi che non garantiscono un adeguato scambio di informazioni con l'Italia. In caso di violazione di tale divieto, il Venditore ha facoltà di risolvere il contratto per giusta causa senza che l'Acquirente possa vantare il diritto di ottenere alcun risarcimento per l'eventuale danno subito.

F.3. Eventuali spese di bollo ed incasso effetti e tratte sono a carico dell'Acquirente. In caso di inadempimento, anche solo parziale, dal giorno fissato per il pagamento decorreranno a favore del Venditore gli interessi moratori nella misura prevista dal d.lgs. 09/10/2002 n. 231.

F.4. Salvo diversi accordi scritti, l'Acquirente si impegna a non compensare alcun credito, comunque insorto, nei confronti del Venditore.

G.- RECLAMI

G.1. Al ricevimento dei Prodotti, l'Acquirente dovrà sottoporli ad accurato controllo attraverso un esame visivo effettuato conformemente alle indicazioni riportate al punto 7 delle norme UNI EN ISO 10545-2

G.2. L'installazione e la posa dei Prodotti deve essere effettuata attenendosi scrupolosamente alle raccomandazioni inerenti le attività da svolgere prima e durante la posa in opera indicate nel documento 1) Manuale di Posa, Uso, Pulizia e Manutenzione pubblicato nel sito internet del Venditore e sulla confezione del prodotto e/o all'interno della stessa. Non sono considerati vizi del Prodotto quelli generati da un'errata installazione e dalla mancata/errata manutenzione (difformi dalle indicazioni fornite nel 1) Manuale di Posa, Uso, Pulizia e Manutenzione), da una non idonea destinazione d'uso e/o dalla normale usura nel tempo.

G.3. Fatti salvi i limiti di accettabilità previsti dalla norma internazionale EN 14411 (ISO 13006), le Parti riconoscono come Vizi Palesi i difetti dei Prodotti riscontrabili già al momento del loro ricevimento tali da rendere il materiale inidoneo all'uso o da diminuirne in modo apprezzabile il valore. Rientrano in tale categoria i difetti come definiti nel documento 1) Manuale di Posa, Uso, Pulizia e Manutenzione pubblicato

nel sito internet del Venditore. A titolo esemplificativo e non esaustivo si riconoscono come Vizi Palesi i difetti superficiali, i difetti di decorazione, di lappatura/levigatura, di calibro, di planarità, di ortogonalità-rettilineità, di spessore, le crepe, le sbecchature, i fuori tono, i toni mescolati e i Prodotti che presentano problemi da taglio/scaglie.

G.4. Nel caso l'Acquirente rilevi Vizi Palesi dovrà fare reclamo al Venditore per iscritto, a pena di decadenza, entro 8 (otto) giorni dal ricevimento e tenere a disposizione del Venditore l'intera partita di materiale. Il reclamo dovrà riportare i dati di fatturazione e una precisa descrizione del vizio reclamato corredata, quando possibile, da immagini fotografiche. Qualora il reclamo dovesse risultare infondato, l'Acquirente si rende disponibile a risarcire il Venditore delle spese sostenute per l'eventuale sopralluogo (perizie, viaggi ecc.).

G.5. I Vizi Occulti dovranno essere notificati al Venditore mediante lettera raccomandata A.R., a pena di decadenza dalla garanzia, entro 8 (otto) giorni dalla data della scoperta del difetto.

G.6. L'azione dell'Acquirente diretta a fare valere la garanzia per vizi si prescrive comunque nel termine di 12 (dodici) mesi decorrenti dalla consegna dei Prodotti.

H.- GARANZIA PER VIZI

H.1. La garanzia del Venditore si intende limitata ai soli Prodotti di prima scelta e non ai Prodotti di seconda o terza scelta o di partite d'occasione con prezzi o sconti particolari quando debitamente segnalati in nota nella Conferma dell'Ordine.

H.2. Il Venditore non garantisce l'idoneità dei Prodotti ad usi particolari, ma soltanto le caratteristiche tecniche pubblicate nel sito internet nel documento 2) Schede tecniche. L'indicazione d'uso, anche quando presentata dal Venditore in cataloghi e manuali, è da ritenersi puramente indicativa. Sulla base delle caratteristiche tecniche riportate nelle 2) Schede Tecniche è sempre compito del progettista valutare l'idoneità del Prodotto alle condizioni specifiche di utilizzo in funzione delle sollecitazioni e delle variabili che si possono verificare nell'ambiente di destinazione alterandone le sue caratteristiche, a titolo d'esempio, all'intensità del traffico, alla qualità del traffico (calpestio in presenza di sabbia, di detriti...), alle eventuali condizioni climatiche avverse e a qualsiasi altra aleatorietà a cui può essere esposto il materiale.

H.3. Nel caso risulti accertato che il Prodotto manifesti Vizi Palesi, come definiti al sub lett. G n.3, il Venditore provvederà alla sostituzione del Prodotto difettoso con altro avente caratteristiche pari o superiori o nel caso ciò non sia possibile ad una congrua riduzione del prezzo. In alternativa l'Acquirente avrà diritto, previa restituzione dei Prodotti viziati, al rimborso del prezzo pagato, maggiorato del costo del trasporto, con esclusione del risarcimento di ogni altro danno diretto e/o indiretto.

H.4. La garanzia del Venditore deve ritenersi esclusa nel caso in cui il Prodotto affetto da Vizi Palesi (in tutto o in parte) sia stato utilizzato e/o comunque trasformato dovendosi ritenere che in tal modo l'Acquirente (o il suo cliente) abbia espresso la volontà di accettarli nello stato in cui si trovano.

H.5. Nel caso risulti accertato che il Prodotto manifesti Vizi Occulti, la garanzia del Venditore è limitata alla sostituzione del materiale con altro avente caratteristiche pari o superiori e ove ciò non sia possibile al rimborso del prezzo pagato maggiorato del costo del trasporto. In ogni caso la garanzia del Venditore per ogni danno diretto e/o indiretto comunque originato dal prodotto difettoso, deve intendersi limitata ad una somma che non potrà superare il doppio del prezzo di vendita applicato dal Venditore in relazione alla sola parte della fornitura difettosa.

H.6. Nel caso l'Acquirente rivenda il Prodotto a soggetti tutelati dal codice del consumo (d.l. n.206/2005) sarà responsabile delle condizioni praticate se difformi da quelle qui riportate e dovrà accertarsi che i diritti del consumatore siano esercitati nel rispetto dei rimedi e dei termini fissati da tale codice. Nel caso sussistano i presupposti, il diritto di regresso e/o comunque di rivalsa spettanti all'Acquirente verso il Venditore/produttore non potrà eccedere le esenzioni ed i limiti come fissati dal sub lett. G n.1 al sub lett. H n.5.

I. CLAUSOLE SOLVE ET REPETE E RISOLUTIVE

I.1. Ai sensi dell'art. 1462 del Codice Civile, per nessun motivo, ivi compresi pretesi vizi o difetti del materiale, l'Acquirente potrà sospendere o ritardare il pagamento del materiale ritirato, salva naturalmente la facoltà di ripetere quando possa dimostrare di avere indebitamente pagato.

I.2. Nel caso di mutamento delle condizioni patrimoniali dell'Acquirente o di mancato pagamento anche parziale di prodotti già forniti, il Venditore può **sospendere**

l'esecuzione delle forniture in corso e/o risolvere i contratti in corso senza che l'Acquirente possa rivendicare risarcimenti diretti e/o indiretti di alcun tipo.

L.- PATTO DI RISERVATO DOMINIO

L.1. Fino a quando l'Acquirente non avrà provveduto all'integrale pagamento del prezzo, i Prodotti oggetto della fornitura rimarranno di proprietà del Venditore.

L.2. Durante il periodo suddetto, l'Acquirente assumerà gli obblighi e le responsabilità del custode, e non potrà alienare, dare in uso, lasciare sequestrare o pignorare tali Prodotti senza dichiarare la proprietà del Venditore e dare immediato avviso a mezzo raccomandata A.R.

M.- FORZA MAGGIORE

M.1. Ciascuna parte potrà sospendere l'esecuzione dei suoi obblighi contrattuali quando tale esecuzione sia resa impossibile o oggettivamente troppo onerosa da un impedimento imprevedibile indipendente dalla sua volontà, quale ad esempio: sciopero, boicottaggio, serrata, incendio, guerra (dichiarata o non), guerra civile, sommosse e rivoluzioni, requisizioni, embargo, interruzioni di energia, rotture straordinarie di macchinari, ritardi nella consegna di componenti o materie prime.

M.2. La parte che desidera avvalersi della presente clausola dovrà comunicare immediatamente per iscritto all'altra parte il verificarsi e la cessazione delle circostanze di forza maggiore.

M.3. Qualora la sospensione dovuta a forza maggiore duri più di 60 (sessanta) giorni, ciascuna parte avrà il diritto di risolvere il presente contratto, previo un preavviso di 10 (dieci) giorni, da comunicarsi alla controparte per iscritto.

N.- OBBLIGO DI RISERVATEZZA

N.1. L'Acquirente è tenuto ad osservare la più assoluta riservatezza su tutte le notizie di carattere tecnico (quali, in via meramente esemplificativa, disegni, prospetti, documentazioni, formule e corrispondenza) e di carattere commerciale (ivi comprese le condizioni contrattuali, i prezzi d'acquisto, le condizioni di pagamento ...) apprese in esecuzione del presente Contratto.

N.2. L'obbligo di riservatezza viene assunto per tutta la durata del Contratto, nonché per il periodo successivo alla sua esecuzione.

N.3. In ogni caso di inosservanza dell'obbligo di riservatezza, la parte inadempiente è tenuta e risarcire all'altra tutti i danni che ne dovessero derivare.

O.- MARCHI E SEGNI DISTINTIVI DEL VENDITORE

O.1. L'utilizzo dei marchi, dei modelli ornamentali e delle opere d'ingegno in genere, in qualunque forma o modo di espressione (quali a titolo meramente esemplificativo, ma non esaustivo: immagini, foto, disegni, filmati, figure, strutture, etc.) costituenti proprietà intellettuale del Venditore, attraverso qualsiasi mezzo (quali a titolo meramente esemplificativo, ma non esaustivo: stampa, video, radio, internet, social media, piattaforme di messaggistica istantanea o VoIP, etc.) è severamente vietato. Qualsiasi deroga a tale divieto, anche solamente parziale, dovrà essere autorizzata per iscritto, caso per caso, dalla Direzione generale del Venditore.

P.- LINGUA DEL CONTRATTO, LEGGE APPLICABILE, GIURISDIZIONE E COMPETENZA

P.1. Il Contratto e le presenti condizioni sono redatti in lingua Italiana, la quale prevarrà nel caso di divergenza con la traduzione in altre lingue.

P.2. La definizione di qualsiasi controversia comunque relativa alle forniture è soggetta alla legge ed alla giurisdizione dello Stato Italiano e la competenza territoriale viene devoluta in via esclusiva al Tribunale di Modena nella cui circoscrizione il Venditore ha la sua sede legale.

Per maggiori informazioni riferirsi alle Condizioni Generali di Vendita, disponibili all'indirizzo www.atlasconcorde.com

Conditions générales de vente

A.- MODALITÉS DE CONCLUSION DU CONTRAT

A.1. Les présentes Conditions Générales de Vente régissent tout contrat de Vente entre le Vendeur et l'Acheteur et toute modification ou dérogation de ces dernières doit être convenue par écrit.

A.2. D'éventuelles offres, accréditations et / ou ristournes accordées par des agents ou par d'autres intermédiaires, ne seront réputées valables que si elles sont confirmées par écrit par le Vendeur.

A.3. L'Acheteur envoie au Vendeur, directement ou par l'intermédiaire d'agents, des Commandes écrites qui doivent indiquer les codes des Produits demandés, les quantités, leur prix et leur destination. La commande envoyée par l'Acheteur est irrévocable.

A.4. La Vente doit être réputée conclue au moment où: (i) l'Acheteur reçoit de la part du Vendeur une Confirmation écrite par e-mail, par télécopie ou par d'autres moyens télématiques, conforme aux conditions de la Commande ; ou (ii) en cas de Confirmation envoyée par le Vendeur contenant des conditions différant de la Commande envoyée par l'Acheteur lorsque celui-ci l'accepte par écrit ou quoi qu'il en soit s'il ne la conteste pas dans un délai de 7 (sept) jours à compter de la réception ; ou (iii) en l'absence d'une confirmation écrite de la part du Vendeur, au moment où les Produits seront livrés et chargés par l'Acheteur.

A.5. L'Acheteur partage l'exigence de limiter les ventes de produits Atlas Concorde au territoire national. Le Vendeur considère cette règle comme un élément indispensable lui permettant de coordonner sa politique commerciale et de rationaliser le réseau de distribution, avec des offres davantage orientées vers les exigences des différents Pays. De même, l'Acheteur reconnaît que cette exigence constitue également une mesure de protection de ses propres intérêts. L'Acheteur s'engage donc à commercialiser les produits fournis par Ceramiche Atlas Concorde SpA exclusivement dans son Pays de résidence, en s'abstenant de promouvoir les ventes actives également sollicitées en ligne auprès de clients situés sur le territoire d'un État différent du sien. Pour les opérations triangulaires, la présente obligation s'applique au pays dans lequel l'acheteur opère effectivement. L'Acheteur pourra revendre le produit hors de son territoire avec l'autorisation écrite du Vendeur, ou si la revente concerne des produits qui ne sont pas de premier choix ou des produits hors production.

B.- PRIX

B.1. Sauf accord contraire, les prix de vente convenus au fur et à mesure sont réputés nets, pour les paiements en espèces et les livraisons Franco l'établissement du Vendeur indiqué sur la Confirmation de Commande.

C.- CARACTÉRISTIQUES DES PRODUITS

C.1. L'Acheteur déclare avoir lu et s'en tenir au contenu de la documentation suivante publiée sur le site Internet de la société: 1) Manuel de Pose, d'Utilisation, de Nettoyage et d'Entretien et 2) Fiches techniques.

C.2. Vu la variabilité intrinsèque du produit en céramique, les caractéristiques des échantillons et / ou des modèles envoyés précédemment par le Vendeur à l'Acheteur sont indicatifs et non contraignants.

C.3. Sauf en cas de demandes spécifiques à convenir avant la Confirmation de Commande, le Vendeur ne garantit pas la commande d'un article soit intégralement constituée par un même lot de production.

D.- DÉLAIS DE LIVRAISON

D.1. Les délais de livraison sont indicatifs et leur éventuelle prorogation ne confère à l'Acheteur aucun droit de demander une indemnisation, sans aucune exception.

D.2. Si, après 14 (quatorze) jours à compter de l'avis de mise à disposition des marchandises, l'Acheteur ne retire pas le matériel, le Vendeur sera dans l'obligation, en raison de la place occupée, de ramener le matériel dans le dépôt, supportant ainsi des coûts supplémentaires ; le Vendeur se réserve la possibilité de facturer ces coûts supplémentaires à l'Acheteur.

E.- LIVRAISON ET EXPÉDITION

E.1.- L'éventuelle variation de la destination des Produits, différente de celle convenue dans la Confirmation de Commande, doit être communiquée par l'Acheteur par écrit au plus tard le second jour qui précède le jour du retrait au siège du Vendeur. Le Vendeur se réserve la faculté de ne pas accepter la variation de la destination des Produits. Au cas où la destination effective du Produit serait différente de celle déclarée par l'Acheteur, le Vendeur se réserve la faculté de suspendre l'exécution des fournitures en cours et / ou de résilier le contrat sans que l'Acheteur puisse revendiquer des

indemnisations directes et / ou indirectes d'aucune sorte.

E.2. Sauf accord contraire, la fourniture de la marchandise est livrée Départ Usine (EXW aux termes des Incoterms 2010) même si l'on a convenu que l'expédition ou une partie de cette dernière sera suivie par le Vendeur sur mandat de l'Acheteur. En tout état de cause, les risques passent à l'Acheteur au plus tard au moment de la livraison au premier transporteur.

E.3. Sans préjudice du désintérêt du Vendeur par rapport au contrat de transport, celui-ci ne pourra être indiqué comme le "shipper" dans le connaissance. La communication du poids brut du container à l'expéditeur, ne constitue pas une prise de responsabilité de la part du Vendeur aux fins de la Convention SOLAS (Safety Of Life At Sea). En aucun cas cette communication ne pourra être considérée comme le VGM (Verified Gross Mass).

E.4. L'Acheteur s'engage à ce que le véhicule envoyé aux entrepôts du Vendeur soit compatible avec la nature des Produits à charger. Si le véhicule qui se présente comporte des difficultés significatives pour les opérations de chargement, le Vendeur se réserve la faculté de débiter une pénalité de l'ordre de 4 % de la valeur des produits pour couvrir les coûts logistiques supplémentaires. Si le véhicule convenu n'est absolument pas compatible, le Vendeur se réserve la faculté de refuser les opérations de chargement sans que l'Acheteur ne puisse rien lui demander à titre de remboursement de toute dépense directe et / ou indirecte éventuelle.

E.5. Il appartient à l'Acheteur de charger le transporteur de contrôler les produits avant le chargement ; d'éventuelles observations concernant l'intégrité des emballages et la correspondance des quantités chargées avec celles indiquées sur le document de transport doivent être soulevées par le transporteur au moment du chargement. Ces observations doivent être indiquées sur toutes les copies des documents de transport ; dans le cas contraire, les produits chargés sont réputés intacts et complets. Il s'ensuit que le Vendeur décline toute responsabilité en cas d'absence ou de détérioration des produits non signalée par le transporteur.

E.6. L'Acheteur a également la responsabilité de charger le transporteur de vérifier les modalités et la stabilité du chargement sur le véhicule afin d'éviter les bris durant le transport et le respect de toutes les dispositions de sécurité concernant la circulation sur route.

F.- PAIEMENTS

F.1. Toute obligation de paiement doit être accomplie au siège légal du Vendeur. Les éventuels paiements remis à des agents, à des représentants ou à des auxiliaires de commerce ne seront réputés effectués qu'au moment où le Vendeur percevra les sommes correspondantes.

F.2. Il est interdit à l'Acheteur d'effectuer des paiements depuis un pays différent de son pays de résidence et ne garantissant pas un échange d'informations correct avec l'Italie. En cas de violation de cette interdiction, le Vendeur a la faculté de résilier le contrat pour juste cause sans que l'Acheteur ne puisse revendiquer le droit d'obtenir une quelconque réparation pour l'éventuel préjudice subi.

F.3. Les éventuels frais de timbre et d'encaissement d'effets et de traites sont à la charge de l'Acheteur. En cas de défaillance, même partielle, des intérêts de retard commencent à courir en faveur du Vendeur, à compter du jour fixé pour le paiement, dans la mesure prévue par le Décret Législatif italien n° 231 du 09/10/2002.

F.4. Sauf accord écrit contraire, l'Acheteur s'engage à ne compenser aucune créance échue.

G.- RÉCLAMATIONS

G.1. À la réception des Produits, l'Acheteur devra soumettre ces derniers à un contrôle minutieux moyennant un examen visuel effectué conformément aux indications du point 7 des normes UNI EN ISO 10545-2.

G.2. L'installation et la pose des Produits doivent être effectuées en suivant scrupuleusement les recommandations inhérentes aux activités exercées avant et durant la pose indiquées sur le document 1) Manuel de Pose, d'Utilisation, de Nettoyage et d'Entretien, publié sur le site Internet du Vendeur ainsi qu'à l'extérieur et/ ou à l'intérieur de l'emballage du produit. Les défauts dus à une installation erronée et à un entretien absent / erroné (ne respectant pas les indications fournies dans le 1) Manuel de Pose, d'Utilisation, de Nettoyage et d'Entretien), par un usage prévu inapproprié et / ou par l'usure normale due au temps ne sont pas considérés comme des vices du Produit.

G.3. Sous réserve des limites d'acceptabilité prévues par la norme internationale EN 14411 (ISO 13006), les Parties reconnaissent comme des Vices Évidents les défauts

des Produits existant dès la réception de sorte que le matériel devienne inutilisable ou qu'il perde une grande partie de sa valeur. Cette catégorie comprend les défauts définis dans le document 1) Manuel de Pose, d'Utilisation, de Nettoyage et d'Entretien publié sur le site Internet du Vendeur. À titre d'exemple non contraignant, on reconnaît comme des Vices Évidents les défauts de surface, de décoration, de polissage, de calibre, de planéité, d'orthogonalité–rectitude, d'épaisseur, les fissures, les ébréchés, les hors nuance, les nuances mélangées et les Produits qui présentent des problèmes de coupe - voile.

G.4. Si l'Acheteur relève des Vices Évidents, il devra présenter une réclamation écrite au Vendeur, sous peine de déchéance, dans un délai de 8 (huit) jours à compter de la réception et tenir le lot complet de matériel à la disposition de ce dernier. La réclamation devra indiquer les données de facturation et une description précise du vice objet de la réclamation, accompagnée, si possible, de photographies. Si la réclamation devait s'avérer sans fondement, l'Acheteur est disposé à rembourser au Vendeur les dépenses encourues pour l'éventuelle visite des lieux (expertises, déplacements, etc.).

G.5. Les Vices Cachés devront être notifiés au Vendeur par lettre recommandée avec avis de réception, sous peine d'annulation de la garantie, dans un délai de 8 (huit) jours à compter de la date de la découverte du défaut.

G.6. L'action de l'Acheteur ayant pour but de faire valoir la garantie en cas de vices se prescrit dans un délai de 12 (douze) mois à compter de la livraison des Produits.

H.- GARANTIE COUVRANT LES VICES

H.1. La garantie du Vendeur est réputée limitée aux seuls Produits de premier choix et non aux Produits de second ou de troisième choix ou à des lots d'occasion auquel on applique des prix ou des remises particuliers lorsqu'ils sont dûment signalés dans les notes de la Confirmation de Commande.

H.2. Le Vendeur ne garantit pas l'adéquation des Produits à des usages particuliers, mais uniquement les caractéristiques techniques publiées sur le site Internet dans le document 2) Fiches techniques. L'usage indiqué, également lorsqu'il est présenté par le Vendeur dans des catalogues et des manuels, est purement indicatif. Sur la base des caractéristiques techniques indiquées dans les 2) Fiches Techniques, le concepteur a toujours le devoir d'évaluer l'adéquation du Produit aux conditions spécifiques d'utilisation en fonction des contraintes et des variables pouvant se vérifier dans le lieu de destination et susceptibles d'en altérer les caractéristiques, par exemple, l'intensité et la qualité de la circulation (piétinement en présence de sable, de détritrus...), ainsi que les éventuelles conditions climatiques défavorables et toute autre incidence à laquelle peut être exposé le matériel.

H.3. Si l'on a constaté que le Produit présente les Vices Évidents définis à la lettre G n°3, le Vendeur remplacera le Produit défectueux par un autre produit ayant des caractéristiques analogues ou supérieures ou, lorsque cela est impossible, à une réduction cohérente du prix. En alternative, l'Acheteur aura droit, après la restitution des Produits défectueux, au remboursement du prix payé, majoré du prix du transport, à l'exclusion du remboursement de tout autre préjudice direct et / ou indirect.

H.4. La garantie du Vendeur doit être réputée exclue au cas où le Produit présentant des Vices Évidents (entièrement ou partiellement) aurait été utilisé et / ou du moins transformé ; dans ce cas, on considérera que l'Acheteur (ou son client) a exprimé la volonté de les accepter en l'état.

H.5. Si l'on a constaté que le Produit présente des Vices Cachés, la garantie du Vendeur se limite au remplacement du matériel par du matériel ayant des caractéristiques analogues ou supérieures et, lorsque cela est impossible, au remboursement du prix payé majoré des frais de transport. En tout état de cause, la garantie du Vendeur couvrant tout dommage direct et / ou indirect causé par le produit défectueux, se limitera à une somme qui ne pourra pas dépasser le double du prix de vente appliqué par le Vendeur dans le cadre de la seule partie de la fourniture défectueuse.

H.6. Si l'Acheteur revend le Produit à des clients protégés par le code de la consommation (Décret–loi italien n° 206/2005) il sera responsable des conditions appliquées si celles-ci diffèrent des conditions indiquées ici et il devra s'assurer que les droits du consommateur sont exercés dans le respect des remèdes et des délais fixés par ce code. Si les conditions sont réunies, le droit de retrait et / ou de recours revenant à l'Acheteur à l'encontre du Vendeur / fabricant ne pourra dépasser ni les exonérations ni les limites établies de la lettre G n°1 à la lettre H n°5.

I. CLAUSES SOLVE ET REPETE ET CLAUSES RÉSOLUTOIRES

I.1. Aux termes de l'art. 1462 du Code Civil italien, en aucun cas, y compris les prétendus vices ou défauts du matériel, l'Acheteur ne pourra suspendre ou retarder le paiement du matériel retiré, sans préjudice naturellement de la faculté d'exiger lorsqu'il est en mesure de démontrer avoir indûment payé.

I.1. En cas de variation des conditions patrimoniales de l'Acheteur ou de non-paiement même partiel de produits déjà fournis, le Vendeur se réserve la faculté de suspendre l'exécution des fournitures en cours et / ou de résilier les contrats sans que l'Acheteur ne puisse revendiquer des indemnisations directes et / ou indirectes d'aucune sorte.

L.- PACTE DE RÉSERVE DE PROPRIÉTÉ

L.1. Tant que l'Acheteur n'aura pas intégralement payé le prix, les Produits objet de la fourniture resteront la propriété du Vendeur.

L.2. Au cours de la susdite période, l'Acheteur assumera les obligations et les responsabilités de gardien, et il ne pourra ni aliéner, ni confier, ni permettre la saisie desdits Produits sans déclarer la propriété du Vendeur et informer immédiatement ce dernier par lettre recommandée avec avis de réception.

M.- FORCE MAJEURE

M.1. Chacune des parties pourra suspendre l'accomplissement de ses obligations contractuelles lorsque cette exécution est rendue impossible ou objectivement trop onéreuse par un empêchement imprévisible indépendant de sa volonté comme : les grèves, les boycottages, les lock-outs, les incendies, les guerres (déclarées ou non), les guerres civiles, les révoltes et les révolutions, les réquisitions, les embargos, les coupures de courant, les ruptures exceptionnelles de machines, les retards de livraison de composants ou de matières premières.

M.2. La partie qui souhaite user de la présente clause devra communiquer immédiatement par écrit à l'autre partie la survenue et la cessation des circonstances de force majeure.

M.3. Si la suspension due à une force majeure dure plus de 60 (soixante) jours, chacune des parties aura le droit de résilier le présent contrat, avec un préavis de 10 (dix) jours, en le communiquant par écrit à la partie adverse.

N.- OBLIGATIONS DE CONFIDENTIALITÉ

N.1. L'Acheteur est tenu d'observer le secret le plus absolu concernant toutes les informations de caractère technique (comme, par exemple, les dessins, les notices, les documentations, les formules et la correspondance) et de caractère commercial (y compris les conditions contractuelles, les prix d'achat, les conditions de paiement, etc.) dont il aurait eu connaissance durant l'exécution du présent Contrat.

N.2. L'obligation de confidentialité est assumée pendant toute la durée du Contrat, ainsi que pour la période successive à son exécution.

N.3. Dans tous cas de non–observation de l'obligation de confidentialité, la partie défaillante est tenue de réparer à l'autre partie tous les éventuels préjudices.

O.- MARQUES ET SIGNES DISTINCTIFS DU VENDEUR

O.1. L'utilisation des marques, des modèles ornementaux et des œuvres de l'esprit en général, sous quelque forme ou suivant quelque modalité d'expression que ce soit (à titre d'exemple, non contraignant : les images, les photos, les dessins, les vidéos, les figures, les structures, etc.) constituant la propriété intellectuelle du Vendeur, à travers tout moyen (à titre d'exemple non contraignant : l'impression, la vidéo, la radio, Internet, les médias sociaux, les plates-formes de messagerie instantanée ou VoIP, etc.) est formellement interdite. Toute dérogation à cette interdiction, même partielle, devra être autorisée par écrit, cas par cas, par la Direction générale du Vendeur.

P.- LANGUE DU CONTRAT, LOI APPLICABLE, JURIDICTION ET COMPÉTENCE

P.1. Le Contrat et les présentes conditions sont rédigés en langue italienne qui prévaudra en cas de divergence avec la traduction dans d'autres langues.

P.2. La définition de toute controverse relative aux fournitures est régie par la loi et la juridiction de l'État italien et les parties reconnaissent la compétence territoriale exclusive du Tribunal de Modène dans la circonscription duquel se trouve le siège légal du Vendeur.

Pour plus de renseignements, consulter les Conditions générales de vente qui sont disponibles à l'adresse www.atlasconcorde.com

Allgemeine Verkaufsbedingungen

A.- MODALITÄT DES VERTRAGSABSCHLUSSES

A.1. Die vorliegenden Allgemeinen Verkaufsbedingungen regeln alle Verträge zwischen dem Verkäufer und dem Käufer und alle Änderungen oder Abweichungen davon müssen schriftlich vereinbart werden.

A.2. Eventuelle Angebote sowie mit Handelsvertretern oder sonstigen Vermittlern vereinbarten Gutschriften sind nicht verbindlich, es sei denn, sie werden vom Verkäufer schriftlich bestätigt.

A.3. Der Käufer sendet dem Verkäufer direkt oder über Handelsvertreter schriftliche Bestellungen zu, die die Angabe der Artikelnummern der gewünschten Produkte, der Mengen, ihres Preises und der Bestimmung enthalten müssen. Die vom Käufer gesendete Bestellung ist unwiderruflich.

A.4. Der Verkauf gilt zu dem Zeitpunkt als abgeschlossen, an dem: (i) der Käufer vom Verkäufer eine schriftliche Bestätigung per E-Mail, Fax oder auf sonstigem Weg erhält, die den Fristen und Bedingungen der Bestellung entspricht; oder (ii) falls die vom Verkäufer gesendete Bestätigung, Bedingungen enthält, die von der vom Käufer erhaltenen Bestellung abweichen, wenn dieser diese akzeptiert oder nicht innerhalb von 7 (sieben) Tagen ab ihrem Empfang beanstandet; oder (iii) falls keine schriftliche Bestätigung durch den Verkäufer erfolgt, zu dem Zeitpunkt, an dem die Produkte geliefert und vom Käufer übernommen werden.

A.5. Der Käufer teilt die Notwendigkeit, das nationale Gebiet für die Verkäufe der Produkt von Atlas Concorde zu unterteilen. Der Verkäufer hält diese Regel für ein unverzichtbares Element, um es ihm zu gestatten, seine kommerzielle Politik zu koordinieren und sein Vertriebsnetz mit Angeboten für die Erfordernisse der einzelnen Länder zu rationalisieren. Außerdem erkennt der Käufer an, dass diese Notwendigkeit auch zum Schutz der eigenen Interessen dient. Der Käufer verpflichtet sich daher, die von Ceramiche Atlas Concorde SpA gelieferten Produkte ausschließlich in dem Land zu vertreiben, in dem er seinen Firmensitz hat, und den aktiven Verkauf – auch online – an Kunden mit Sitz in einem anderen Staat zu unterlassen. Für Dreiecksgeschäfte wird die vorliegende Pflicht auf das Land angewendet, in dem der Käufer effektiv tätig ist. Der Käufer kann das Produkt außerhalb seines eigenen Gebiets verkaufen, falls er die schriftliche Genehmigung des Verkäufers einholt, oder falls der Verkauf nicht Produkte erster Wahl oder Produkte außerhalb der Produktion betrifft.

B.- PREISE

B.1. Vorbehaltlich abweichender schriftlicher Vereinbarungen gelten die von Mal zu Mal vereinbarten Verkaufspreise als Nettobarpreise bar mit Lieferung frei ab dem in der Auftragsbestätigung angegebenen Werk des Verkäufers.

C.- EIGENSCHAFTEN DER PRODUKTE

C.1. Der Käufer erklärt, die folgende auf der Web-Site des Unternehmen veröffentlichte Dokumentation zur Kenntnis genommen zu haben und sich an deren Inhalt zu halten:

1) Handbuch zur Verlegung, Benutzung, Reinigung und Pflege, und 2) Technische Datenblätter.

C.2. Aufgrund der intrinsischen Variabilität des Keramikprodukts sind die Eigenschaften der vorausgehend vom Verkäufer an den Käufer gesendeten Warenmuster und/oder Modelle hinweisend und unverbindlich.

C.3. Vorbehaltlich spezifischer Vereinbarungen vor der Auftragsbestätigung garantiert der Verkäufer nicht, dass die Lieferung des einzelnen Artikels vollständig mit dem gleichen Produktionslos ausgeführt wird.

D.- LIEFERFRISTEN

D.1. Die Lieferbedingungen sind richtungsweisend; durch eine eventuelle Verlängerung entsteht für den Käufer ausnahmslos kein Recht auf Schadenersatz.

D.2. Wenn der Käufer das Material nicht innerhalb von 14 (vierzehn) Tagen ab der Mitteilung der Bereitstellung der Ware abholt, ist der Verkäufer aus Platzgründen gezwungen, das Material an die Lagerorte zurückzubringen, wodurch zusätzliche Kosten entstehen; der Verkäufer behält sich das Recht vor, dem Käufer diese zusätzlichen Kosten in Rechnung zu stellen.

E.- RÜCKLIEFERUNG UND VERSAND

E.1. Die eventuelle Änderung des Bestimmungsortes der Produkte, die sich von der in der Auftragsbestätigung vereinbarten unterscheidet, muss vom Käufer schriftlich innerhalb des zweiten Tags vor dem für die Abholung am Sitz des Verkäufers vorgesehenen mitgeteilt werden. Der Verkäufer behält sich das Recht vor, die Änderung der Bestimmung der Produkte nicht zu akzeptieren. Falls sich herausstellt, dass die effektive Bestimmung des Produkts von der vom Käufer angegebenen verschieden ist,

behält sich der Verkäufer das Recht vor, die laufenden Lieferungen nicht auszuführen und/oder die laufenden Verträge aufzulösen, ohne dass der Käufer jeglichen Anspruch auf Entschädigung geltend machen kann.

E.2. Vorbehaltlich abweichender Vereinbarungen erfolgt die Lieferung der Ware frei ab Werk (EXW gemäß den Incoterms 2010), und dies auch, falls vereinbart wird, dass der Versand oder ein Teil desselben im Auftrag des Käufers durch den Verkäufer erfolgt. In jedem Fall gehen die Risiken spätestens mit der Übergabe an das erste Transportunternehmen an den Käufer über.

E.3. Unter Beibehaltung der Nichtbeteiligung des Verkäufers am Transportvertrag kann der Verkäufer in der Police der Ladung als „Shipper“ angegeben werden. Die Mitteilung des Bruttogewichts des Containers an den Transportunternehmer stellt keine Übernahme der Verantwortung des Verkäufers hinsichtlich der SOLAS-Konvention dar (Safety Of Life At Sea). In keinem Fall kann diese Mitteilung als VGM (Verified Gross Mass) verstanden werden.

E.4. Der Käufer verpflichtet sich sicherzustellen, dass das zu den Lagern des Verkäufers gesendete Fahrzeug unter Berücksichtigung der Natur der Produkte für das Laden geeignet ist. Falls das zum Laden gesendete Fahrzeug größere Probleme beim Beladen bereitet, behält der Verkäufer sich das Recht vor, zur Abdeckung der höheren Logistikkosten eine Vertragsstrafe in Höhe von 4 % des Werts der Produkte zu erheben. Falls das Fahrzeug vollkommen ungeeignet ist, behält sich der Verkäufer das Recht vor, das Verladen zu verweigern, ohne dass der Käufer einen Anspruch auf Vergütung der Schäden geltend machen kann, die direkt und/oder indirekt daraus entstehen können.

E.5. Es ist Aufgabe des Käufers, das Transportunternehmen zu beauftragen und die Produkte vor dem Laden zu kontrollieren; eventuelle Anmerkungen zur Unversehrtheit der Verpackungen und der Übereinstimmung der geladenen Menge mit der in den Transportpapieren angegebenen müssen vom Transportunternehmen zum Zeitpunkt des Ladens vorgenommen werden. Diese Anmerkungen müssen auf alle Exemplaren der Transportpapiere vermerkt werden, anderenfalls gelten die geladenen Produkte als unbeschädigt und vollständig. Daraus folgt, dass der Verkäufer keinerlei Haftung für Fehlmengen oder Beschädigungen der Produkte übernimmt, die vom Transportunternehmen nicht gemeldet werden.

E.6. Es ist ebenfalls Aufgabe des Käufers, das Transportunternehmen zu beauftragen und die Modalität und die Stabilität des Ladens auf das Fahrzeug zu überprüfen, damit es während des Transports nicht zu Brüchen kommt, sowie die Einhaltung der Sicherheitsbestimmungen der Straßenverkehrsordnung zu gewährleisten.

F.- ZAHLUNGEN

F.1. Alle Zahlungsverpflichtung müssen am Firmensitz des Verkäufers erfüllt werden. Eventuelle Zahlungen an Handelsvertreter oder Außendienstmitarbeiter gelten als nicht geleistet, bis sie beim Verkäufer eingehen.

F.2. Es ist dem Käufer untersagt, die Zahlungen aus Ländern vorzunehmen, die vom Land seines Firmensitzes verschieden sind, falls diese Länder keinen angemessenen Informationsaustausch mit Italien gewährleisten. Im Fall der Verletzung dieses Verbots hat der Verkäufer das Recht, den Vertrag aus gutem Grund aufzulösen, ohne dass der Käufer eine Vergütung des entstandenen Schadens geltend machen kann.

F.3. Eventuelle Kosten und Gebühren für die Einziehung von Effekten und Wechseln gehen zu Lasten des Käufers. Im Fall der Nichteinhaltung des für die Zahlung festgesetzten Tags - auch nur partiell - fallen Säumniszinsen zu Gunsten des Verkäufers an, in der vom ital. Gesetzlerlass vom 9. Oktober 2002, Nr. 231 vorgesehenen Höhe.

F.4. Vorbehaltlich abweichender schriftlicher Vereinbarungen verpflichtet sich der Käufer, keine Guthaben gegenüber dem Verkäufer zu verrechnen.

G.- BEANSTANDUNGEN

G.1. Beim Empfang der Produkte muss der Käufer sie einer sorgfältigen Sichtkontrolle gemäß den Angaben von Punkt 7 der Normen UNI EN ISO 10545-2 unterziehen.

G.2. Die Installation und die Verlegung der Produkte müssen unter Einhaltung der Empfehlungen zu den Arbeiten ausgeführt werden, die vor und während der Verlegung ausgeführt werden müssen, wie angegeben im Dokument 1) Handbuch zur Verlegung, Verwendung, Reinigung und Pflege, veröffentlicht auf der Web-Site des Verkäufers und angegeben auf der Verpackung des Produkts und/oder im Inneren derselben. Schäden, die durch eine falsche Installation, Verlegung und durch eine unterlassene/falsche Pflege (abweichend von den Angaben in 1) Handbuch zur Verlegung, Reinigung und Wartung), durch eine ungeeignete Gebrauchsbestimmung oder durch normale Abnutzung verursacht werden, werden nicht als Mängel des Produkts anerkannt.

G.3. Vorbehaltlich der Grenzen der Akzeptabilität, die von der internationalen Norm

EN 14411 (ISO 13006) vorgesehen sind, erkennen die Parteien Mängel der Produkte als offensichtliche Mängel an, die bereits bei ihrem Empfang festgestellt werden können, die das Material zur Verwendung ungeeignet machen oder die den Wert beträchtlich verringern. In diese Kategorie fallen Mängel, wie im Dokument definiert 1) Handbuch zur Verlegung, Benutzung, Reinigung und Pflege, veröffentlicht auf der Web-Site des Verkäufers. Als nicht erschöpfende Beispiele werden Oberflächenmängel, fehlerhafte Grafik, Defekte polierte Oberfläche, Defekte des Kalibers, der Planarität, der Rechtwinkligkeit/Gradlinigkeit, der Stärke, Risse, abgeschlagene Kanten, Fehlfarbe, gemischte Brandfarbe sowie Produkte mit Kantsplitterung durch Rettifizierung als offensichtliche Mängel anerkannt.

G.4. Falls der Käufer offensichtliche Mängel feststellt, muss er dies dem Verkäufer innerhalb von 8 (acht) Tagen ab dem Empfang schriftlich melden und die gesamte Charge des Materials für den Verkäufer zur Verfügung halten; anderenfalls verfällt der Rechtsanspruch. Bei der Beanstandung müssen die Daten der Rechnung sowie eine präzise Beschreibung des beanstandeten Mangels angegeben werden, falls möglich mit einer fotografischen Dokumentation. Falls die Beanstandung unberechtigt sein sollte, ist der Käufer gehalten, dem Verkäufer die für einen eventuellen Ortstermin aufgewendeten Kosten (Gutachten, Reisekosten, usw.) zu erstatten.

G.5. Versteckte Mängel müssen dem Verkäufer innerhalb von 8 (acht) Tagen ab Feststellung des Mangels per Einschreiben mit Rückschein gemeldet werden; anderenfalls verfällt der Rechtsanspruch.

G.6. Die Aktion des Käufers zur Inanspruchnahme der Mängelhaftung muss in jedem Fall innerhalb von 12 (zwölf) Monaten ab der Lieferung der Produkte erfolgen.

H.- MÄNGELHAFTUNG

H.1. Die Garantie des Verkäufers ist begrenzt auf Produkte erster Qualität und sie bezieht sich nicht auf Produkte zweiter oder dritter Qualität oder auf gelegentliche Partien mit besonderen Preisen oder Nachlässe, die in der Auftragsbestätigung angegeben werden.

H.2. Der Verkäufer garantiert nicht die Eignung der Produkte für besondere Verwendungen, sondern lediglich die technischen Eigenschaften, die auf der Web-Site in Dokument 2) Technische Datenblätter veröffentlicht sind. Die Angabe zur Verwendung ist als unverbindlich anzusehen, auch wenn vom Verkäufer in Katalogen und Handbüchern angegeben ist. Es ist stets Aufgabe des Planers, auf der Grundlage der in den 2) Technischen Datenblättern angegebenen Eigenschaften die Eignung des Produkts für spezifische Nutzungsbedingungen zu bewerten, unter Berücksichtigung der Belastungen sowie der Variablen, die am Ort der Bestimmung auftreten und die Eigenschaften verändern können, wie zum Beispiel die Intensität des Verkehrs, die Qualität des Verkehrs (Begehung bei Vorhandensein von Sand, Schmutz usw.), die eventuellen klimatischen Bedingungen sowie alle sonstigen Einflüsse, denen das Material ausgesetzt sein kann.

H.3. Falls festgestellt wird, dass das Produkt offensichtliche Mängel aufweist, wie definiert in Punkt G, Nr. 3, nimmt der Verkäufer die Ersetzung des mangelhaften Produkts durch ein anderes mit gleichen oder höherwertigen Eigenschaften vor, oder er nimmt eine angemessene Reduzierung des Preises vor, falls dies nicht möglich ist. Alternativ hat der Käufer nach Rücklieferung der mangelhaften Produkte das Recht auf Rückerstattung des bezahlten Preises, zuzüglich der Transportkosten, mit Ausschließung der Vergütung aller direkten und/oder indirekten Schäden.

H.4. Die Garantie des Verkäufer wird ausgeschlossen, falls das mangelhafte Produkt (ganz oder teilweise) verwendet und/oder umgewandelt worden ist, da davon ausgegangen wird, dass der Käufer (oder sein Kunde) dadurch seinen Willen zum Ausdruck gebracht hat, es in dem Zustand zu akzeptieren, in dem es sich befindet.

H.5. Falls festgestellt wird, dass das Produkt versteckte Mängel aufweist, ist die Garantie des Verkäufers auf die Ersetzung des Materials durch anderes mit gleichen oder höherwertigeren Eigenschaften beschränkt oder - falls dies nicht möglich ist - auf die Rückerstattung des bezahlten Preises, zuzüglich der Transportkosten. In jedem Fall ist die Garantie des Verkäufers für alle direkten und/oder indirekten Schäden, die durch das mangelhafte Produkt entstehen, auf einen Betrag begrenzt, der das Doppelte des Verkaufspreises nicht übersteigen kann, den der Verkäufer auf den mangelhaften Teil der Lieferung angewendet hat.

H.6. Falls der Käufer das Produkt an Kunden weiterverkauft, die vom Verbraucherschutzgesetz (ital. Gesetzlerlass Nr. 206/2005) geschützt werden, ist er verantwortlich für die angewendeten Bedingungen, falls diese von den hier angegebenen abweichen, und er muss sicherstellen, dass die Rechte des Verbrauchers gemäß den Bestimmungen dieses Gesetzes ausgeübt werden können. Falls die

Voraussetzungen gegeben sind, kann das Regressrecht des Käufers gegenüber dem Verkäufer/Hersteller nicht die Grenzen übersteigen, die von Punkt G, Nr. 1 bis Punkt H, Nr. 5 angegeben werden.

I. KLAUSEL SOLVE ET REPETE UND AUFLÖSUNGSKLAUSEL

I.1. Gemäß den Bestimmungen von § 1462 des ital. Bürgerlichen Gesetzbuches kann der Käufer in keinem Fall - einschließlich von vermeintlichen Mängeln oder Defekten des Materials - die Zahlung des abgenommenen Materials aussetzen oder verzögern, natürlich vorbehaltlich des Rechts, ungerechtfertigt gezahlte Beträge zurückzufordern, und dies nur nach Erbringung des Nachweises der Rechtmäßigkeit der Forderung (Solve et Repete).

I.2. Im Fall der Veränderung der Vermögensbedingungen des Käufers oder der auch nur partiellen Nichtbezahlung der bereits gelieferten Produkte kann der Verkäufer die laufenden Lieferungen aussetzen und/oder die laufenden Verträge auflösen, ohne dass der Käufer die Vergütung von direkten und/oder indirekten Schäden geltend machen kann.

L.- EIGENTUMSVORBEHALT

L.1. Bis zur vollständigen Bezahlung des Preises durch den Käufer bleiben die Produkte, die den Gegenstand der Lieferung darstellen, Eigentum des Verkäufers.

L.2. Während dieses Zeitraums übernimmt der Käufer die Pflichten und die Verantwortlichkeiten für die Aufbewahrung der gekauften Produkte und er kann sie nicht veräußern, zur Nutzung überlassen oder beschlagnahmen oder pfänden lassen, ohne das Eigentum des Verkäufers anzugeben und ohne diesen umgehend per Einschreiben mit Rückschein zu benachrichtigen.

M.- HÖHERE GEWALT

M.1. Beide Parteien können die Ausführung der vertraglichen Pflichten aussetzen, wenn die Ausführung aus Gründen, die vom eigenen Willen unabhängig sind, unmöglich oder objektiv zu aufwendig wird, wie zum Beispiel: Streiks, Boykott, Aussperrung, Brand, Krieg (erklärt oder nicht), Bürgerkrieg, Aufstände und Revolutionen, Beschlagnahme, Embargo, Unterbrechungen der Energieversorgung, außerordentliche Defekte von Maschinen, Verspätung bei der Anlieferung von Komponenten und Rohstoffen.

M.2. Die Partei, die beabsichtigt, die vorliegende Klausel in Anspruch zu nehmen, muss der anderen Partei schriftlich das Auftreten von Umständen der Höheren Gewalt mitteilen.

M.3. Falls die Aussetzung aufgrund von Höherer Gewalt mehr als 60 (sechzig) Tage andauert, haben beiden Parteien das Recht, den vorliegenden Vertrag nach einer schriftlichen Vorankündigung von 10 (zehn) Tagen an die Gegenpartei aufzulösen.

N.- VERTRAULICHKEITSPFLICHT

N.1. Der Käufer ist gehalten, über alle technischen Informationen (wie zum Beispiel Zeichnungen, Prospekte, Dokumentationen, Formeln und Schriftverkehr) und kommerziellen Informationen (einschließlich der Vertragsbedingungen, der Kaufpreise, der Zahlungsbedingungen usw.), in deren Kenntnis während der Ausführung des vorliegenden Vertrages kommt, absolute Vertraulichkeit einzuhalten.

N.2. Die Vertraulichkeitspflicht wird für die Dauer des Vertrages sowie den Zeitraum nach seiner Ausführung übernommen.

N.3. Im Fall der Nichteinhaltung der Vertraulichkeitspflicht ist die nicht einhaltende Partei gehalten, der anderen Partei alle daraus entstehenden Schäden zu vergüten.

O.- MARKEN UND KENNZEICHNUNGEN DES VERKÄUFERS

O.1. Die Verwendung von Marken, Ziermotiven und geistigem Eigentum im Allgemeinen in jeder Form sowie jeder Ausdrucksform (als nicht erschöpfendes Beispiel: Bilder, Fotos, Zeichnungen, Filme, Abbildungen, Strukturen usw.), die intellektuelles Eigentum des Verkäufers sind, ist auf jede Weise (als nicht erschöpfendes Beispiel: Presse, Video, Radio, Internet, Social Media, Instant-Message-Plattform oder VoIP usw.) strengstens untersagt. Alle - auch nur partielle - Abweichungen von diesem Verbot müssen von Fall zu Fall schriftlich von der Generaldirektion des Verkäufers autorisiert werden.

P.- SPRACHE DES VERTRAGS, ANWENDBARES RECHT, RECHTSPRECHUNG UND RICHTSSTAND

P.1. Der Vertrag und die vorliegenden Bedingungen werden in italienischer Sprache verfasst, die im Fall der Abweichung der Übersetzung in andere Sprachen Vorrang hat.

P.2. Die Regelung aller Rechtssachen hinsichtlich den Lieferungen unterliegt der Rechtsprechung des italienischen Staats und die territoriale Zuständigkeit liegt ausschließlich beim Bezirksgericht Modena, dem Ort des Firmensitzes des Verkäufers.

Weitere Informationen entnehmen Sie bitte den Allgemeinen Geschäftsbedingungen, die unter der Adresse www.atlasconcorde.com zur Verfügung stehen.

Condiciones generales de venta

A.- MODALIDADES DE CELEBRACIÓN DEL CONTRATO

A.1. Las presentes Condiciones Generales de Venta disciplinan todo contrato de venta entre el Vendedor y el Comprador y toda modificación o cancelación debe ser establecida por escrito.

A.2. Eventuales ofertas, acreditaciones y/o descuentos otorgados por agentes u otros intermediarios, no son considerados válidos mientras no sean confirmados por escrito por el Vendedor.

A.3. El Comprador envía al Vendedor, directamente o a través de agentes, pedidos por escrito que deben contener la indicación de los códigos de los productos requeridos, de las cantidades, de sus precios y de su destino. El pedido enviado por el Comprador es irrevocable.

A.4. La venta deberá considerarse perfeccionada desde el momento en que: (a) el Comprador recibe por parte del Vendedor una confirmación -escrita a través de e-mail, fax u otros medios telemáticos- conforme con los términos y según las condiciones del pedido; o (b) en caso de confirmación enviada por el Vendedor que contenga condiciones diferentes de las del pedido enviado por el Comprador cuando este las acepte por escrito o, en todo caso, no las cuestione dentro de los 7 (siete) días sucesivos a la recepción; o (c) en ausencia de confirmación escrita por el Vendedor, en el momento en que los productos serán entregados y serán cargados por el Comprador.

A.5. El Comprador comprende y acepta la necesidad de limitar al territorio nacional las ventas de los productos Atlas Concorde. El Vendedor estima que esta norma constituye un factor indispensable para poder coordinar su política comercial y racionalizar la red de distribución, con ofertas más orientadas a los requerimientos de cada país. De igual modo, el Comprador reconoce que este requerimiento constituye también salvaguardia de sus propios intereses. Por lo tanto, el Comprador se obliga a comercializar los productos suministrados por Ceramiche Atlas Concorde SpA exclusivamente en su país de residencia, absteniéndose de promover ventas activas, solicitadas incluso online, respecto a clientes domiciliados en el territorio de cualquier otro país que no sea el propio. Para operaciones triangulares esta obligación se aplica al país de operatividad efectiva del Comprador.

El Comprador podrá revender el producto fuera de su propio territorio en caso de recibir autorización por escrito por parte del Vendedor o en caso de que la reventa se refiera a productos que no sean de primera selección o que estén fuera de producción.

B.- PRECIOS

B.1. Salvo acuerdo escrito en contrario, los precios de venta acordados de manera puntual se entienden al neto en efectivo y para entrega en el establecimiento del Vendedor indicado en la confirmación del pedido.

C.- CARACTERÍSTICAS DE LOS PRODUCTOS

C.1. El Comprador declara haber visto y atenerse al contenido de la siguiente documentación publicada en el sitio internet de la empresa: 1) Manual de Colocación, Uso, Limpieza y Mantenimiento y 2) Fichas Técnicas.

C.2. Dada la intrínseca variabilidad del producto cerámico, las características de las muestras y/o modelos enviados anteriormente por el Vendedor al Comprador deben ser considerados como aproximados y no vinculantes.

C.3. Salvo especificaciones requeridas, a acordar antes de la confirmación del pedido, el Vendedor no garantiza que el pedido de un artículo en particular sea despachado como un mismo lote de producción.

D.- PLAZOS DE ENTREGA

D.1. Los plazos de entrega son orientativos y su demora no conlleva derecho alguno a solicitar indemnización alguna por parte del comprador, sin excepciones.

D.2. Si el comprador no recogiera el material transcurridos 14 (catorce) días desde la fecha del aviso de estar lista la mercancía, por necesidad de espacio el vendedor se verá obligado a devolver dicho material al almacén, lo que conlleva unos costes añadidos reservándose el mismo la facultad de cargarlos al comprador.

E.- ENTREGA Y TRANSPORTE

E.1. La eventual variación de lugar de destino de los productos, señalando uno diferente respecto de aquel acordado en la confirmación de pedido, debe ser comunicada por el Comprador por escrito dentro del plazo máximo taxativo del penúltimo día previo al retiro desde el establecimiento del Vendedor. El Vendedor se reserva la facultad de no aceptar el cambio de lugar de destino de los Productos. En caso de verificarse que el destino efectivo del producto sea diferente de aquel declarado por el Comprador, el Vendedor se reserva la facultad de suspender la

realización de los suministros en curso y/o de rescindir los contratos en curso sin que el Comprador pueda pedir resarcimientos directos y /o indirectos de ningún tipo.

E.2. Salvo acuerdo en contrario, el suministro de la mercancía se entiende ex Works (EXW según Incoterms 2010) y ello también cuando se acuerde que el transporte o parte de él quede a cargo del Vendedor, según mandato del Comprador. En todo caso, los riesgos se transfieren al Comprador a más tardar con la entrega al primer transportador.

E.3. Como confirmación del hecho de que el Vendedor es ajeno al contrato de transporte, el mismo no podrá ser indicado como "shipper" en la póliza de carga. La comunicación del peso bruto del contenedor al transportista no comporta ninguna asunción de responsabilidad de parte del Vendedor para los fines del Convenio SOLAS (Safety Of Life At Sea). De ninguna manera la antedicha comunicación podrá ser considerada como VGM (Verified Gross Mass).

E.4. El Comprador se compromete a fin de que el vehículo enviado al establecimiento del Vendedor sea idóneo para cargar considerando la naturaleza de los productos. En caso de que el vehículo que se presenta comporte significativas dificultades para las operaciones de carga, el Vendedor se reserva el derecho a incluir una recarga del 4 % del valor de los productos a cobertura de los mayores costos logísticos. Si el vehículo enviado para retirar la mercancía no es absolutamente idóneo, el Vendedor se reserva la facultad de negar las operaciones de carga sin que nada pueda requerir el Comprador a título de resarcimiento por todo eventual costo directo y/o indirecto que de ello pueda derivar.

E.5. Es tarea del Comprador encargar al transportista controlar los productos antes de cargarlos; eventuales observaciones sobre la integridad de los embalajes y la exactitud de las cantidades cargadas, así como aquellas puestas en el documento de transporte, deben ser presentadas por el transportista en el momento de cargar. Estas observaciones deben ser reproducidas en todas las copias de los documentos de transporte; de lo contrario los productos cargados se entienden íntegros y completos. De ello deriva que el Vendedor no se asume ninguna responsabilidad con referencia a faltas o daños en los productos no señalados por el transportista.

E.6. Asimismo, es responsabilidad del Comprador encargar al transportista verificar las modalidades y la estabilidad de la carga sobre el vehículo a fin de que durante el transporte no se produzcan roturas y que sean respetadas todas las disposiciones sobre seguridad relativas a la circulación por vías públicas.

F.- PAGOS

F.1. Toda obligación de pago debe ser cumplida en la sede legal del Vendedor. Eventuales pagos a agentes, representantes o auxiliares de comercio no se entienden efectuadas mientras las respectivas sumas no lleguen a poder del Vendedor.

F.2. Queda prohibido para el Comprador cumplir su propia obligación mediante pagos provenientes de países que no sean su propio país de residencia si se trata de países que no garantizan adecuado intercambio de informaciones con Italia. En caso de violación de esta prohibición, el Vendedor tiene facultad de rescindir el contrato por justa causa sin que el Comprador pueda pretender derecho de obtener algún resarcimiento por eventual daño sufrido.

F.3. Eventuales gastos de sello fiscal y de cobro de letras de cambio y efectos comerciales quedan a cargo del Comprador. En caso de incumplimiento, incluso solo parcial, del día fijado para el pago, se devengarán a favor del Vendedor los intereses de mora en la medida prevista por el Decreto Leg. nº 231 del 09/10/2002.

F.4. Salvo acuerdos escritos que lo contradigan, el Comprador se compromete a no compensar ningún crédito de cualquier forma creado respecto del Vendedor.

G.- RECLAMOS

G.1. Al recibir los productos, el Comprador deberá someterlos a cuidadoso control a través de un examen visual efectuado conforme según las indicaciones del punto 7.4 de las normas UNI EN ISO 10545-2.

G.2. La instalación y colocación de los productos deberá efectuarse respetando escrupulosamente las recomendaciones inherentes a las actividades a realizar antes y durante la colocación, indicadas en el documento 1) Manual de Colocación, Uso, Limpieza y Mantenimiento publicado en el sitio internet del Vendedor y en el embalaje del producto y/o en el interior del mismo. No son considerados como vicios del producto aquellos generados por una errónea instalación y error/falta de mantenimiento (intervenciones diferentes de las instrucciones proporcionadas en el 1) Manual de Colocación, Uso, Limpieza y Mantenimiento), por un uso inapropiado y/o por el normal desgaste con el pasar del tiempo.

G.3. Sin perjuicio de los límites de aceptabilidad previstos por la norma internacional EN 14411 (ISO 13006), las partes reconocen como vicios evidentes los defectos de los productos constatables ya en el momento de su recepción y tales que impidan el uso previsto del material o reduzcan de modo apreciable su valor. Forman parte de esta categoría los defectos precisamente establecidos en el documento 1) Manual de Colocación, Limpieza y Mantenimiento publicado en el sitio internet del Vendedor. A título solo de ejemplo, se reconocen como vicios evidentes los defectos superficiales, los defectos de decoración, de lepeado/pulido, de calibre, de planitud, de ortogonalidad-rectilineidad, de espesor, las grietas, los astillados, las variaciones de tono, los tonos mezclados y los productos que presentan problemas de cortes/escamas.

G.4. En caso de que el Comprador observe la presencia de vicios evidentes, deberá presentar reclamo al Vendedor por escrito, so pena de extinción del derecho, dentro de los 8 (ocho) días sucesivos a la recepción y mantener a disposición del Vendedor la partida completa de material. El reclamo deberá indicar los datos de facturación y una precisa descripción del vicio observado incluyendo, en lo posible, imágenes fotográficas. En caso de que el reclamo debiera demostrarse luego ser infundado, el Comprador se declara dispuesto a resarcir al Vendedor por los gastos efectuados para realizar la respectiva constatación in situ (peritajes, viajes, etc.).

G.5. Los vicios ocultos deberán ser notificados al Vendedor mediante carta certificada con aviso de recibo, bajo pena de caducidad de la garantía, dentro de los 8 (ocho) días a contar de la fecha del descubrimiento del defecto.

G.6. La acción del Comprador tendiente a hacer valer la garantía por vicios prescribe, en todo caso, en el plazo de 12 (doce) meses a contar de la entrega de los productos.

H.- GARANTÍA POR VICIOS

H.1. La garantía del Vendedor se entiende limitada solo a los productos de primera selección y no a los productos de segunda o tercera selección o de partidas de ocasión con precios o descuentos especiales cuando ello se encuentra debidamente señalados en nota en la confirmación del pedido.

H.2. El Vendedor no garantiza la idoneidad de los productos para usos particulares, sino solo las características técnicas publicadas en el sitio internet, documento 2) Fichas Técnicas. La indicación de uso, incluso cuando es presentada por el Vendedor en catálogos y manuales, debe considerarse solo como genérica. Sobre la base de las características técnicas señaladas en las 2) Fichas Técnicas, es siempre tarea del proyectista evaluar la idoneidad del producto en función de las condiciones específicas de uso en consideración de las solicitudes y de las variables que pueden operar en el ambiente de destino, alterando sus características; a título de ejemplo: la intensidad del tráfico, la calidad del tráfico (tránsito en presencia de arena, de detritos, etc.), las eventuales condiciones climáticas adversas y cualquier otro factor aleatorio al que puede quedar expuesto el material.

H.3. En caso de comprobarse que el producto manifieste vicios evidentes, tal como han sido definidos en la letra G nº. 3, el Vendedor procederá a sustituir el producto defectuoso con otro con características iguales o superiores o, en el caso de que ello no sea posible, deberá efectuar una congrua reducción del precio. Como alternativa, el Comprador tendrá derecho, previa devolución de los productos viciados, al reembolso del precio pagado, agregándose el costo del transporte, con exclusión del resarcimiento de todo otro daño, directo y/o indirecto.

H.4. La garantía del Vendedor debe considerarse excluida en caso de que el producto que presenta vicios evidentes (total o parcialmente) haya sido utilizado y/o, en cualquier caso, transformado, debiéndose estimar que de tal modo el Comprador (o su cliente) ha expresado la voluntad de aceptarlo en el estado en que se encuentra.

H.5. En los casos en que quede comprobado que el producto presenta vicios ocultos, la garantía del Vendedor queda limitada a la sustitución del material con otro de características iguales o superiores y, allí donde ello no sea posible, al reembolso del precio pagado, agregándose el costo del transporte. En todo caso, la garantía del Vendedor por cada daño directo y/o indirecto de cualquier forma derivado de producto defectuoso, debe entenderse limitada a una suma que no podrá superar el doble del precio de venta aplicado por el Vendedor, con referencia solo a la parte defectuosa del suministro.

H.6. En caso de que el Comprador revenda el producto a terceros protegidos por el código del consumo (D.L. nº. 206/2005), será responsable de las condiciones practicadas si son diferentes de aquellas aquí señaladas y deberá comprobarse que los derechos del consumidor sean ejercidos con aplicación de los remedios y de los términos fijados por el antedicho código. En caso de subsistir las condiciones, el

derecho de devolución y/o, en todo caso, de compensación a favor del Comprador respecto del Vendedor/productor, no podrán excederse las exenciones ni límites establecido en la letra G del nº. 1 y en la letra H nº. 5.

I. CLÁUSULAS SOLVE ET REPETE Y RESOLUTIVAS

I.1. De conformidad con lo dispuesto por el art. 1462 del Código Civil, por ningún motivo, incluidos supuestos vicios o defectos del material, el Comprador podrá suspender o retardar el pago del material retirado, sin perjuicio obviamente de la facultad de restitución cuando pueda demostrar que ha pagado indebidamente.

I.2. En el caso de cambiar las condiciones patrimoniales del Comprador o de falta de pago incluso parcial de productos ya suministrados, el Vendedor podrá suspender la realización de los suministros en curso y/o rescindir los contratos en curso sin que el Comprador pueda reivindicar resarcimientos directos ni indirectos de cualquier clase.

L.- PACTO DE RESERVADO DOMINIO

L.1. Mientras el Comprador no haya efectuado el pago integral del precio, los productos objeto del suministro seguirán siendo de propiedad del Vendedor.
L.2. Durante el período antedicho, el Comprador asumirá las obligaciones y las responsabilidades del depositario y no podrá enajenar, entregar en uso ni dejar retener o embargar los productos sin declarar la propiedad del Vendedor y enviar inmediatamente aviso con carta certificada con aviso de recibo.

M.- FUERZA MAYOR

M.1. Cada parte podrá suspender la ejecución de sus obligaciones contractuales cuando esa ejecución se haga imposible u objetivamente demasiado onerosa por impedimento imprevisible independiente de su voluntad, tal como por ejemplo: huelga, boicot, bloqueo, incendio, guerra (declarada o no declarada), guerra civil, rebelión y revolución, requisición, embargo, interrupción de energía, rotura extraordinaria de maquinaria, retraso en la entrega de componentes o materias primas.

M.2. La parte que desee valerse de la presente cláusula deberá comunicar de inmediato por escrito a la otra parte el verificarse y el cese de las circunstancias de fuerza mayor.

M.3. En caso de que la suspensión causada por fuerza mayor dure más de 60 (sesenta) días, cada una de las partes tendrá derechos de rescindir el presente contrato, con preaviso de 10 (diez) días, a comunicar a la otra parte por escrito.

N.- OBLIGACIÓN DE CONFIDENCIALIDAD

N.1. El Comprador debe mantener la más absoluta confidencialidad respecto de todas las informaciones de carácter técnico (tales como, solo como ejemplo, diseños, prospectos, documentaciones, fórmulas y correspondencia) y de carácter comercial (incluidas las condiciones contractuales, los precios de compra, las condiciones de pago, etc.) obtenidas a propósito de la ejecución del presente contrato.

N.2. La obligación de confidencialidad es válida por toda la duración del contrato, así como por el período sucesivo a su ejecución.

N.3. En cualquier caso de inobservancia de la obligación de confidencialidad, la parte incumplidora deberá indemnizar a la otra por todos los daños que de ello puedan derivar.

O.- MARCAS Y SIGNOS DISTINTIVOS DEL VENDEDOR

O.1. Queda severamente prohibido el uso a través de cualquier medio (tales como, solo a título de ejemplos no exhaustivos: prensa, videos, radio, internet, social media, plataformas de mensajería instantánea o VoIP, etc.) de las marcas, de los modelos ornamentales y de las obras del ingenio en general que constituyan propiedad intelectual del Vendedor y ello en cualquier forma o modo de expresión (tales como, solo a título de ejemplos no exhaustivos: imágenes, fotos, dibujos, videos, figuras, estructuras, etc.). Cualquier excepción a esta prohibición, incluso solo parcial, deberá ser autorizada caso por caso por escrito por la dirección general del Vendedor.

P.- IDIOMA DEL CONTRATO, LEY APLICABLE, JURISDICCIÓN Y COMPETENCIA

P.1. El contrato y las presentes condiciones son redactados en lengua italiana, la cual prevalecerá en caso de divergencia con las traducciones en otros idiomas.

P.2. La resolución de cualquier controversia de cualquier forma relativa al suministro queda sujeta a la ley y a la jurisdicción del Estado Italiano y la competencia territorial es asignada de forma exclusiva al Tribunal de Módena, en cuya circunscripción el Vendedor tiene su domicilio legal.

Para mayor información, consultar las Condiciones Generales de Venta, disponible en la dirección www.atlasconcorde.com

Общие условия продажи

A.- ПОРЯДОК ЗАКЛЮЧЕНИЯ ДОГОВОРА

A.1. Настоящие Общие условия продажи регулируют любой договор продажи, заключенный между Продавцом и Покупателем; любое изменение или отступление от них должно быть согласовано в письменной форме.

A.2. Возможные коммерческие предложения, зачисления и/или бонусы, предоставленные агентами или другими посредниками, не имеют силы, если они не были подтверждены в письменной форме Продавцом.

A.3. Покупатель направляет Продавцу непосредственно или через агентов письменные заказы, в которых должны быть указаны коды запрошенной продукции, количества, цены и место назначения. Отправленный Покупателем заказ отмене не подлежит.

A.4. Продажа считается завершённой в тот момент, когда: (i) Покупатель получает от Продавца по электронной почте, факсу или другим телематическим средствам связи письменное подтверждение, соответствующее срокам и условиям заказа; или (ii) в случае, если в отправленном Продавцом подтверждении указаны условия, отличающиеся от условий в заказе Покупателя, если Покупатель письменно принимает это подтверждение или не возражает на него в течение 7 (семи) дней после его получения; или (iii) при отсутствии письменного подтверждения Продавца, в тот момент, когда Продукция передается Покупателю и загружается им.

A.5. Покупатель соглашается с необходимостью ограничить территорию продажи продукции Atlas Concorde государственными границами. Продавец считает это правило необходимым элементом, который позволит ему координировать свою коммерческую политику и оптимизировать дистрибутивную сеть посредством предложений, которые будут больше соответствовать потребностям отдельных стран. Аналогично этому, Покупатель соглашается, что эта необходимость представляет собой защиту также и его интересов. Таким образом, Покупатель обязуется реализовывать продукцию, поставленную компанией Ceramiche Atlas Concorde SpA, лишь только в его стране, воздерживаясь от продвижения активной продажи, также онлайновой, клиентам, находящимся на территории другой страны. В операциях триангуляции данное обязательство распространяется на страну, в которой ведется реальная оперативная деятельность Покупателя.

Покупатель сможет перепродать продукцию за пределами своей территории в том случае, если он получит письменное разрешение Продавца, или же в случае перепродажи продукции не первого сорта или снятой с производства.

B.- ЦЕНЫ

B.1. При отсутствии иных письменных договоренностей согласованные в каждом отдельном случае отпускные цены подразумеваются как цены нетто, за наличный расчет и на условиях поставки франко завод Продавца, указанный в подтверждении заказа.

C.- ХАРАКТЕРИСТИКИ ПРОДУКЦИИ

C.1. Покупатель заявляет, что он ознакомился и придерживается содержания следующей документации, размещенной на корпоративном сайте в интернете: 1) Руководство по укладке, использованию, чистке и уходу и 2) Технические данные.

C.2. Учитывая свойственное непостоянство керамической продукции, характеристики образцов и/ моделей, ранее отправленных Продавцом Покупателю, должны считаться ориентировочными и не обязывающими.

C.3. При отсутствии специальных требований, которые должны быть оговорены до подтверждения заказа, Продавец не гарантирует, что заказ на отдельное изделие будет полностью состоять из одной и той же производственной партии.

D.- СРОКИ ПОСТАВКИ

D.1. Сроки поставки являются ориентировочными: их продление не дает Покупателю права на запрос компенсаций, без каких-либо исключений.

D.2. Если по истечении 14 (четырнадцати) дней с даты уведомления о готовности товара Покупатель не заберет материал, Продавец будет вынужден, по причине занимаемой площади, вернуть материал на склад, что приведет к дополнительным расходам; Продавец оставляет за собой право взыскать такие дополнительные расходы с Покупателя.

E.- ДОСТАВКА И ОТГРУЗКА

E.1. О возможном изменении места назначения Продукции, если оно отличается от места, согласованного в подтверждении заказа, необходимо сообщить Продавцу в письменной форме не позднее, чем за два дня до даты, предусмотренной для вывоза товара с завода Продавца. Продавец оставляет за собой право не принимать изменение места назначения Продукции. Если устанавливается, что фактическое место назначения Продукции отличалось от заявленного Покупателем, то Продавец оставляет за собой

право на приостановку исполнения текущих поставок и/или на расторжение текущих договоров без права Покупателя на требование прямого или косвенного возмещения какого-либо типа.

E.2. При отсутствии иных договоренностей поставка товара подразумевается на условиях франко-завод (EXW в соответствии с правилами Incoterms 2010), даже если было согласовано, что отгрузка или ее часть должна осуществляться Продавцом по поручению Покупателя. В любом случае риск переходит к Покупателю не позднее чем при передаче товара первому грузоперевозчику.

E.3. Исходя из того, что Продавец не является стороной договора перевозки, в коносаменте не допускается указание Продавца как "грузоотправителя". Сообщение Продавцом грузоперевозчику веса брутто контейнера не является принятием на себя ответственности в соответствии с конвенцией СОЛАС (Safety Of Life At Sea). Это сообщение не может ни в коем случае толковаться как проверка массы грузеных контейнеров VGM (Verified Gross Mass).

E.4. Покупатель обязуется направить на склад Продавца транспортное средство, пригодное для погрузки Продукции данного типа. Если прибывшее транспортное средство значительно затрудняет выполнение погрузочных операций, то Продавец оставляет за собой право наложить пению в размере 4% от стоимости продукции за возмещение более высоких логистических расходов. Если согласованное транспортное средство является совершенно неподходящим, Продавец оставляет за собой право отказать в выполнении погрузочных операций, при этом Покупатель не может требовать возмещения вытекающего из этого любого прямого и/или косвенного убытка.

E.5. Покупатель обязан поручить грузоперевозчику проверку продукции перед ее погрузкой. Возможные замечания о целостности упаковки и о соответствии загруженных количеств тем, которые указаны в транспортной накладной, должны быть сделаны грузоперевозчиком в момент погрузки. Эти замечания необходимо указать во всех копиях транспортных накладных, в противном случае погруженная продукция считается неповрежденной и комплектной. Из этого следует, что Продавец не несет никакой ответственности за недочеты или повреждения продукции, не отмеченные грузоперевозчиком.

E.6. Кроме того, Покупатель также обязан поручить грузоперевозчику проверку порядка погрузки и стабильности груза в транспортном средстве, чтобы во время перевозки не возникли повреждения, и чтобы были соблюдены все правила безопасности дорожного движения.

F.- ОПЛАТА

F.1. Любые платежные обязательства должны выполняться по юридическому адресу Продавца.Оплата агентам, представителям или торговым помощникам считается несовершенной до тех пор, пока соответствующие суммы не поступят Продавцу.

F.2. Покупателю запрещается выполнять свои обязательства путем оплаты из стран, не являющихся страной, резидентом которой он является, если эти страны не гарантируют адекватный обмен информацией с Италией. В случае нарушения этого запрета Продавец имеет право на расторжение договора с надлежащим правовым основанием, а у Покупателя не возникнет право на получение какого-либо возмещения за понесенный ущерб.

F.3. Пошлины и расходы на инкассирование векселей и тратт несет Покупатель. В случае даже частичной задержки платежа по сравнению с назначенным днем оплаты в пользу Продавца будут начисляться проценты в размере, предусмотренном законодательным декретом от 09/10/2002 № 231.

F.4. При отсутствии иных письменных договоренностей Покупатель обязуется не компенсировать никакой кредит по отношению к Продавцу, вне зависимости от причин его возникновения.

G.- ПРЕТЕНЗИИ

G.1. При получении Продукции Покупатель должен внимательно осмотреть ее в соответствии с указаниями п. 7 стандарта UNI EN ISO 10545-2

G.2. При установке и укладке Продукции необходимо внимательно придерживаться рекомендаций по работам, выполняемым до и во время укладки, приведенных в документе 1) Руководство по укладке, использованию, чистке и уходу, размещенном на сайте Продавца в интернете, а также рекомендаций, указанных на упаковке изделия и/или приведенных внутри упаковки. Не считаются дефектами Продукции дефекты, возникшие в результате неправильной установки, отсутствия / неправильного ухода (не в соответствии с указаниями, приведенными в 1) Руководстве по укладке, использованию, чистке и уходу), по причине неподходящей сферы применения и/или обычного износа с течением времени.

G.3. Соблюдая пределы приемлемости, предусмотренные международным стандартом EN 14411 (ISO 13006), стороны признают как явные дефекты те дефекты Продукции, которые были заметными уже при ее получении, и которые делают материал неподходящим для применения или существенно снижают его ценность. В эту категорию входят дефекты в соответствии с определением, приведенным в документе 1) Руководство по укладке, использованию, чистке и уходу, размещенном на сайте Продавца в интернете. В качестве неисчерпывающего перечня признаются как явные дефекты следующие: дефекты поверхности, декора, шлифовки/полировки, калибра, плоскостности, ортогональности-прямолинейности, толщины, трещины, сколы, несоответствие тона, смешение тона, а также изделия с дефектами резки и сколами.

G.4. Если Покупатель обнаруживает явные дефекты, то он должен предъявить претензию Продавцу в письменном виде в течение 8 (восьми) дней с момента получения Продукции, в противном случае он теряет право на претензию, кроме того, Покупатель должен оставить всю партию материала в распоряжении Продавца. В претензии необходимо указать данные инвойса и точное описание дефекта, сопровождая его, если это возможно, фотографиями. Если претензия окажется необоснованной, то Покупатель должен быть готовым возместить Продавцу расходы, понесенные им в связи с осмотром на месте (экспертизы, проезд и тд.).

G.5. О скрытых дефектах необходимо сообщить Продавцу заказным письмом с уведомлением о вручении в течение не более 8 (восьми) дней с момента обнаружения дефекта, в противном случае гарантия теряет силу.

G.6. В любом случае, предоставленная Покупателю гарантия на дефекты теряет силу по истечении 12 (двенадцати) месяцев с момента получения Продукции.

H.- ГАРАНТИЯ НА ДЕФЕКТЫ

H.1. Гарантия Продавца распространяется только на Продукцию первого сорта, и не распространяется на Продукцию второго, третьего сорта, а также на партии со спецпредложениями, по которым были предложены специальные скидки или цены, отмеченные в примечаниях в подтверждении заказа.

H.2. Продавец не гарантирует пригодность Продукции для специальных видов применения, а лишь только ее технические характеристики, размещенные на сайте в интернете, в документе 2) Технические данные. Сфера применения, даже если она указана Продавцом в каталогах и руководствах, должна считаться лишь только ориентировочной. На основании технических характеристик, приведенных в 2) Технических данных, проектировщик обязан оценить пригодность Продукции к конкретным условиям применения, в зависимости от нагрузок и от переменных факторов, которые могут возникнуть в среде применения, изменяя характеристики Продукции, такие как: интенсивность хождения, качество хождения (наличие песка, мусора и тд.), возможные неблагоприятные климатические условия и любые другие случайные факторы, которые могут оказать воздействие на материал.

H.3. В случае установления того факта, что Продукция имеет явные дефекты в соответствии с положениями п. 3 раздела G, Продавец заменит дефектную Продукцию другой, обладающей такими же или более высокими характеристиками. Если это невозможно, то он надлежащим образом снизит цену. В качестве альтернативы после возврата дефектной Продукции Покупатель имеет право на возмещение уплаченной цены и транспортных расходов, при этом исключено возмещение любого другого прямого и/или косвенного ущерба.

H.4. Гарантия Продавца считается отмененной в случае, если Продукция, частично или полностью имеющая явные дефекты, была использована и/ или трансформирована каким-либо образом, поскольку считается, что этими действиями Покупатель (или его клиент) выразил волю принять Продукцию в том состоянии, в котором она находится.

H.5. В случае установления того факта, что Продукция имеет скрытые дефекты, гарантия Продавца ограничена заменой материала другим, обладающим такими же или более высокими характеристиками. Если это невозможно, то Продавец возместит уплаченную цену и транспортные расходы. В любом случае, гарантия Продавца на любой прямой и/или косвенный ущерб, вызванный каким-либо образом дефектной Продукцией, ограничена суммой, которая не может превышать больше, чем в два раза, востребованную Продавцом отпускную цену, и лишь только в отношении к дефектной части поставки.

H.6. Если Покупатель перепродает Продукцию лицам, которые защищены Кодексом потребителя (законодательный декрет № 206/2005), то он несет ответственность за предоставляемые условия, если они отличаются от приведенных здесь, кроме того, он обязан удостовериться в том, что права потребителя защищаются с соблюдением мер и сроков, предусмотренных вышеуказанным Кодексом.При наличии соответствующих

предпосылок право регресса и/или право на взыскание убытков, которое Покупатель имеет по отношению к Продавцу/производителю, не может превышать исключения и пределы, установленные в п. 1 раздела G и в п. 5 раздела H.

I. УСЛОВИЯ ОБ ОБЯЗАТЕЛЬНОЙ ОПЛАТЕ (SOLVE ET REPETE) И О ДОСРОЧНОМ ОДНОСТОРОННЕМ РАСТОРЖЕНИИ

I.1. В соответствии со ст. 1462 гражданского кодекса Покупатель не вправе ни по какой причине, в том числе в связи с претензиями по поводу качества или дефектности товара, приостанавливать или задерживать оплату вывезенного материала, сохраняя, тем не менее, право требовать возмещение, если он докажет неправомерное взимание оплаты.

I.2. В случае изменения имущественного положения Покупателя или даже частичной неоплаты уже поставленной Продукции, Продавец может приостановить исполнение текущих поставок и/или расторгнуть текущие договоры, и Покупатель не имеет права потребовать какого-либо возмещения прямых и/или косвенных убытков.

L.- ПОЛОЖЕНИЕ О СОХРАНЕНИИ ПРАВА СОБСТВЕННОСТИ

L.1. Поставляемая Продукция будет оставаться в собственности Продавца до тех пор, пока Покупатель полностью не оплатит ее.

L.2. В течение этого периода Покупатель несет обязательства и ответственность хранителя и не может уступать, предоставлять в пользование, разрешать наложение имущественного ареста или опись Продукции, не заявив, что она находится в собственности Продавца, и не известив его немедленно заказным письмом с уведомлением о вручении.

M.- ФОРС-МАЖОР

M.1. Любая из сторон имеет право приостановить исполнение своих контрактных обязательств, если это исполнение стало невозможным или объективно обременительным по причине непредвиденных событий, насодящихся вне ее контроля, таких как, например: забастовка, бойкот, локаут, пожар, война (объявленная или нет), гражданская война, бунт, революция, конфискация, эмбарго, энергетическая блокада, непредвиденный выход из строя оборудования, задержки в поставках компонентов или сырья.

M.2. Сторона, желающая сослаться на настоящее условие, должна немедленно сообщить в письменной форме другой стороне о возникновении и прекращении форс-мажорных обстоятельств.

M.3. Если приостановка в связи с форс-мажорными обстоятельствами продлится более 60 (шестидесяти) дней, то каждая из сторон имеет право расторгнуть настоящий договор, отправив предварительное письменное уведомление об этом другой стороне за 10 (десять) дней.

N.- ОБЯЗАТЕЛЬСТВО О НЕРАЗГЛАШЕНИИ КОНФИДЕНЦИАЛЬНОЙ ИНФОРМАЦИИ

N.1. Покупатель обязан соблюдать максимальную конфиденциальность о всей информации технического характера (такая как, но не ограничиваясь этим, чертежи, проспекты, документация, формулы и переписка) и коммерческого характера (включая договорные условия, отпускные цены, условия платежа и тд.), которая попала в его распоряжение в ходе исполнения настоящего договора.

N.2. Обязательство о неразглашении конфиденциальной информации действует в течение всего срока действия договора, а также в период после его исполнения.

N.3. В случае невыполнения обязательства о неразглашении конфиденциальной информации невыполняющая сторона обязана возместить другой стороне все убытки, вытекающие из ее нарушения.

O.- ТОРГОВЫЕ МАРКИ И ОТЛИЧИТЕЛЬНЫЕ ЗНАКИ ПРОДАВЦА

O.1. Категорически запрещается использование торговых марок, орнаментальных промышленных образцов и предметов интеллектуальной собственности вообще, в любом виде или форме выражения (например, только в качестве неполного перечня: изображения, фотографии, чертежи, видеосъемки, рисунки, конструкции и тд.), являющихся интеллектуальной собственностью Продавца, в любых СМИ (например, только в качестве неполного перечня: печать, видеоканалы, радиовещание, интернет, социальные сети, платформы для обмена сообщениями или VoIP-платформы). Любое, даже только частичное отступление от этого запрета должно письменно разрешаться в каждом отдельном случае Генеральной дирекцией Продавца.

P.- ЯЗЫК ДОГОВОРА, ПРИМЕНИМЫЙ ЗАКОН, ЮРИСДИКЦИЯ И КОМПЕТЕНЦИЯ

P.1. Договор и настоящие условия составлены на итальянском языке, который преобладает в случае разночтений с переводом на другие языки.

P.2. Любой спор, каким-либо образом связанный с поставками, регулируется итальянским законом и подлежит юрисдикции Итальянского государства, а территориальная компетенция принадлежит исключительно суду г. Модены, в округе которого Продавец имеет свой юридический адрес.

Больше информации можно найти в Общих условиях продажи по адресу www.atlasconcorde.com

MADE IN ITALY



The Made in Italy logo of Atlas Concorde stands for style, quality and ethics. Having firmly adhered to the Ethical Code promoted by Confindustria Ceramica, Atlas Concorde places the Made in Italy logo on all the products designed and produced in Italy, that is to say ceramic tiles, decorations and the majority of special trim tiles. Only a small amount of the latter is manufactured in Spain. Atlas Concorde products are produced using eco-friendly technologies, top quality and safe raw materials with the best working conditions guaranteed for our personnel. For these reasons, Atlas Concorde's Made in Italy is the expression of strong values such as style, design, product quality, and respect for the environment and the people who live in it.

Il marchio Made in Italy di Atlas Concorde è sinonimo di stile, qualità ed etica. Avendo aderito con convinzione al Codice Etico di Confindustria Ceramica, Atlas Concorde appone il marchio Made in Italy su tutti i prodotti studiati, progettati e realizzati in Italia, nella fattispecie tutte le piastrelle di ceramica, le decorazioni e la maggioranza dei pezzi speciali. Solo un ristretto numero di questi ultimi è fabbricato in Spagna. I prodotti Atlas Concorde sono inoltre realizzati con tecnologie rispettose dell'ambiente, utilizzando materie prime eccellenti e sicure, garantendo le migliori condizioni di lavoro. Per queste ragioni il Made in Italy di Atlas Concorde è espressione di valori forti quali stile, design, qualità del prodotto, attenzione all'ambiente e alle persone.

Le label Made in Italy d'Atlas Concorde est synonyme de style, de qualité et d'éthique. Atlas Concorde a adhéré au Code Éthique de Confindustria Céramique avec conviction et appose le label Made in Italy sur tous les produits étudiés, projetés et fabriqués en Italie : dans ce cas, sur tous les carreaux en céramique, les décorations et la plupart des pièces spéciales. Seul un nombre restreint de ces dernières est fabriqué en Espagne. Les produits Atlas Concorde sont en outre fabriqués avec des technologies qui respectent l'environnement et utilisent des matières premières excellentes et sûres, dans la garantie des meilleurs conditions de travail. Pour ces raisons, le Made in Italy d'Atlas Concorde exprime des valeurs fortes telles que le style, le design, la qualité du produit et le respect de l'environnement et des personnes.

La marca Made in Italy de Atlas Concorde es sinónimo de estilo, calidad y ética. Adhiriendo con convicción el Código Ético de Confindustria Cerámica, Atlas Concorde señala con la marca Made in Italy todos los productos estudiados, diseñados y realizados en Italia, en este caso todas las baldosas de cerámica, las decoraciones y la mayoría de piezas especiales. Sólo un restringido número de estas últimas se fabrica en España. Los productos Atlas Concorde se realizan además con tecnologías que respetan el medio ambiente, usando materias primas excelentes y seguras, garantizando las mejores condiciones de trabajo. Por dichas razones el Made in Italy de Atlas Concorde es la manifestación de valores sólidos como estilo, diseño, calidad del producto, cuidado del medio ambiente y las personas.

Die Marke Made in Italy von Atlas Concorde ist ein Synonym für Stil, Qualität und Ethik. Aus Überzeugung haben wir uns dem Ethischen Kodex der Confindustria Ceramica (Dachverband der ital. Unternehmen und Unternehmensverbände der Keramikbranche) angeschlossen. Atlas Concorde bringt die Marke Made in Italy auf allen seinen Produkten an die in Italien geplant, entwickelt und realisiert werden, d.h. alle Keramikfliesen, Dekore, Bordüren und der Hauptteil der Spezialteile. Nur eine geringe Anzahl der letzteren werden in Spanien gefertigt. Die Produkte von Atlas Concorde werden darüberhinaus unter Verwendung ausgezeichneter und sicherer Rohstoffe mittels umweltschützender Technologien unter besten Arbeitsbedingungen hergestellt. Aus diesen Gründen ist Made in Italy von Atlas Concorde ein Ausdruck starker Werte wie Stil, Design, Produktqualität.

Маркировка Made in Italy на плитках Atlas Concorde – синоним стиля, качества и этики. С уверенностью приняв «Этический кодекс» федерации Confindustria Ceramica (ассоциация предприятий керамической отрасли), компания отмечает этим знаком все изделия, разработанные и изготовленные в Италии: керамические плитки, декоры и большинство специальных элементов. Лишь ограниченная часть последних производится в Испании. Изделия Atlas Concorde изготовлены с использованием надёжного, высококачественного сырья и передовых технологий, гарантирующих экологическую совместимость производства и оптимальные рабочие условия. Для Atlas Concorde Made in Italy – это выражение важных ценностей, таких как стиль, дизайн, качество. Это уважение к человеку и природе.



The Ceramics of Italy logo is an exclusive identification on ceramic products which have effectively been made in Italy by companies that are a part of the Confindustria Ceramica and who adhered to its Ethical Code. This Code, promoted and created by Confindustria Ceramica, commits all companies to communicate, clearly and with transparency, the origin of their products.

Il marchio Ceramics of Italy contrassegna esclusivamente i prodotti ceramici effettivamente realizzati in Italia da un'azienda associata a Confindustria Ceramica che ha sottoscritto il Codice Etico. Il Codice, redatto dalla stessa Confindustria Ceramica, impegna a comunicare con chiarezza l'origine dei prodotti.

Le label Ceramics of Italy distingue exclusivement les produits en céramique qui sont effectivement fabriqués en Italie par les sociétés associées à Confindustria Céramique ayant souscrit le Code Éthique. Ce Code, rédigé par Confindustria Céramique, engage ceux qui le souscrivent à communiquer clairement l'origine des produits.

Die Marke Ceramics of Italy zeichnet ausschließlich Keramikprodukte aus, die in Italien, von Unternehmen, welche dem Dachverband der ital. Unternehmen und Unternehmensverbände der Keramikbranche angehören und sich dem Ethischen Kodex verschrieben haben, hergestellt werden. Der Kodex, von diesem Dachverband ins Leben gerufen, verpflichtet sich zur klaren Angabe und Mitteilung der Herkunft der Produkte.

La marca Ceramics of Italy distingue exclusivamente los productos cerámicos realizados efectivamente en Italia por una empresa afiliada a Confindustria Cerámica que ha suscrito el Código Ético. El Código, redactado por Confindustria Cerámica, compromete a quien lo ratifica a comunicar con claridad el origen de los productos.

Знаком Ceramics of Italy маркируются только керамические изделия, которые изготовлены действительно в Италии предприятием-членом федерации Confindustria Ceramica, подписавшим «Этический кодекс». Кодекс разработан самой федерацией и обязывает ясно указывать происхождение товара.

NOTES | NOTE

Notes | Anmerkungen

Notas | Примечание

Atlas Concorde reserves the right to modify any product without notice and will not be liable for any direct or indirect damage resulting from such modifications.

Atlas Concorde si riserva di modificare i prodotti senza preavviso, declinando ogni responsabilità su eventuali danni diretti o indiretti derivanti da eventuali modifiche. / Atlas Concorde se réserve le droit de modifier ses produits sans préavis et décline toute responsabilité concernant les éventuels dommages directs ou indirects qui pourraient dériver de ces modifications | Atlas Concorde behält sich das Recht vor jederzeit und ohne vorherige Ankündigung, die Produkte zu verändern, und lehnt jede Haftung bei direkten oder indirekten Schäden ab, die von diesen Veränderungen herrühren | Atlas Concorde se reserva el derecho de modificar los productos sin previo aviso, rechaza cualquier responsabilidad sobre eventuales daños directos o indirectos derivados de eventuales modificaciones | Atlas Concorde оставляет за собой право изменять характеристики изделий без предварительного уведомления, отклоняя при этом любую ответственность за прямые или косвенные убытки, возникшие в результате изменений.

Colours and optical features of the materials illustrated in this catalogue are to be regarded as mere indications.

I colori e le caratteristiche estetiche dei materiali illustrati nel presente catalogo sono da ritenersi puramente indicativi. / Les coloris et les caractéristiques esthétiques des références illustrées dans le catalogue sont donnés à titre purement indicatif | Die Farben und die ästhetischen Eigenschaften der in diesem Katalog abgebildeten Produkte sind als reine Richtwerte zu betrachten | Los colores y las características estéticas de los materiales ilustrados en el presente catálogo deben ser considerados como puramente indicativos | Цвета и эстетические характеристики описанных в настоящем каталоге материалов являются только ориентировочными.

For information and details relating to codes, packaging and weight it is recommended to refer to the latest pricelist.

Per le informazioni e i dati relativi a codici, imballaggi e pesi occorre sempre consultare l'ultimo listino aggiornato e in vigore. / Pour toutes informations et renseignements concernant les codes, les emballages et les poids, il y a toujours lieu de consulter le dernier tarif en vigueur et mis à jour | Für Informationen und Daten die den Code, die Verpackung und das Gewicht betreffen bitte die aktuellste Preisliste zugrunde legen | Para acceder a la información y a los datos relativos a códigos, embalajes y pesos hay que consultar siempre la última lista de precios actualizada y vigente | Для информации о кодах, упаковках и весе обращайтесь к последнему действующему прайс-листу.

Ceramic products can have slight variations in tone. Check with the sales representative for the possibility of combining production lots, formats, decorations and special pieces.

Il prodotto ceramico può essere leggermente variabile in termini di toni. Verificare con il referente commerciale l'abbinabilità sia tra i lotti produttivi che tra i formati e i decori o i pezzi speciali. /Le produit céramique peut légèrement différer sur l'aspect de la couleur. Vérifier avec le référent commercial que l'assortiment soit entre les lots de fabrication qu'entre les formats et les décors ou les pièces spéciales | Im keramischen Produkt sind Abweichungen von Farbton möglich. Wenden Sie sich bitte an den Verkaufsleiter, um zu überprüfen, wie man die verschiedenen Posten, Formate, Dekore oder Spezialteile miteinander kombinieren kann | El producto cerámico puede variar levemente en lo que respecta a los tonos. Consulte con el representante de ventas la combinación entre los lotes producidos y entre los formatos y las decoraciones o las piezas especiales | Керамические изделия разных партий могут слегка отличаться по тону. Проверьте вместе с торговым представителем сочетаемость с изделиями других партий, а также с форматами, декоративными или специальными элементами.

The production sizes of special pieces in porcelain tiles may vary from the nominal sizes provided for in current standards (ISO 13006 – EN 14411 Annex G) for non-modular tiles.

Le dimensioni di fabbricazione dei pezzi speciali in gres porcellanato possono derogare dalle dimensioni nominali previste dalle normative vigenti (ISO 13006 - EN 14411 appendice G) per le piastrelle non modulari. / Les dimensions de fabrication des pièces spéciales en grès cérame peuvent déroger aux dimensions nominales prévues par les règlements en vigueur (ISO 13006 - EN 14411 annexe G) pour les carreaux non modulaires. | Die Produktionsmaße der Formteile aus Feinsteinzeug können für die nicht modularen Fliesenformate von den Sollmaßen der geltenden Normen (ISO 13006 - EN 14411 Anhang G) abweichen. | Los tamaños de fabricación de las piezas especiales de gres porcelánico pueden ser diferentes de las dimensiones nominales previstas por las normas vigentes (ISO 13006 - EN 14411 aréndice G) para las baldosas no modulares. | Производственные размеры специальных элементов из керамогранита могут отклоняться от номинальных размеров, предусмотренных действующими стандартами (ISO 13006 - EN 14411, Приложение G) для немодульных плиток.

The actual dimensions of the special pieces and the smaller pieces obtained by cutting porcelain tiles could deviate from the tolerances in the catalog, which instead for the rectified formats are guaranteed by Atlas Concorde.

Le dimensioni reali dei pezzi speciali e dei sottoformati ottenuti da tagli in gres porcellanato potrebbero derogare rispetto alla tolleranze presenti a catalogo garantite da Atlas Concorde sui formati rettificati. / Les dimensions réelles des pièces spéciales et des sous formats obtenus à partir des coupes en grès cérame pourraient varier par rapport aux tolérances présentes au catalogue garanties par Atlas Concorde sur les formats rectifiés. | Die tatsächlichen Abmessungen der Formstücke und der geschnittenen Unterformate aus Feinsteinzeug können von den im Katalog genannten, von Atlas Concorde für rektifizierte Formate garantierten Toleranzen abweichen. | Las dimensiones reales de las piezas especiales y de los subformatos obtenidos por cortes de gres porcelánico, podrían no cumplir con las tolerancias indicadas en el catálogo, garantizadas por Atlas Concorde para los formatos rectificados. | Фактические размеры специальных элементов и подформатов, полученных путем разрезания керамогранита, могут отклоняться от допусков, указанных в каталоге и гарантируемых компанией Atlas Concorde для ретифицированных форматов.

Copyright 2021 by Ceramiche Atlas Concorde S.p.A - The reproduction of the work, fully or in part, is strictly forbidden.

Copyright 2021 by Ceramiche Atlas Concorde S.p.A - È vietata la riproduzione, anche parziale, dell'opera in tutte le sue forme.

Copyright 2021 by Ceramiche Atlas Concorde S.p.A - Toute reproduction, même partielle, de l'œuvre dans toutes ses formes est interdite.

Copyright 2021 by Ceramiche Atlas Concorde S.p.A - Die Reproduktion, ganz oder teilweise, des Werkes in all seinen Formen ist verboten

Copyright 2021 by Ceramiche Atlas Concorde S.p.A - Está prohibida la reproducción, incluso parcial, de la obra en todas sus formas.

Copyright 2021 by Ceramiche Atlas Concorde S.p.A - Запрещается любое полное или частичное воспроизведение данной работы.



Ceramiche Atlas Concorde S.p.A.
Via Canaletto 141
41042 Spezzano di Fiorano (MO) – Italia

Atlas Concorde USA, Inc.
117 Seaboard Lane – Suite F170
Franklin, TN 37067 – USA

Atlas Concorde Russia
Business centre “Meliora Place”
Prospekt Mira 6
129090 Moscow – Russia

atlasconcorde.com