

MADE IN ITALY. MADE TO EXCEL.

EXENCE

Interactive version

 **atlas concorde**

March 2023

WOOD LOOK

**PORCELAIN TILES
GRES PORCELLANATO**
Grès cérame
Feinsteinzeug
Gres porcelánico
Керамический гранит



Atlas Concorde is a global specialist in premium porcelain and wall tiles for every style and application in residential, commercial and public architecture. Being global specialists means excellence in the level of design and technology in each type of surface, making it possible to always offer designers and end users the best solution for each application.

Atlas Concorde è specialista globale in superfici ceramiche d'eccellenza per ogni stile e applicazione nell'architettura residenziale, commerciale e pubblica. Essere specialisti globali significa eccellere per livello di design e tecnologia in ciascun tipo di superficie, così da offrire sempre ai progettisti e agli utilizzatori finali la soluzione migliore per ogni applicazione.

atlasconcorde.com



INDEX



OVERVIEW



IMAGE
GALLERY



SURFACE
RANGE &
TECHNICAL
SPECS.



WE CARE





EXENCE

The Harmony of Wood

Overview

Image Gallery

Surface Range & Technical Specs

SENSITECH TECHNOLOGY
COLLECTION RANGE
TECHNICAL SPECIFICATIONS

We Care

PORCELAIN TILES: A SAFE CHOICE
ENVIRONMENTAL SUSTAINABILITY
ETHICAL IDENTITY

OVERVIEW



IMAGE GALLERY



SURFACE RANGE & TECHNICAL SPECS.



WE CARE



Natural accents.



Designed to decorate living spaces with a contemporary look, the Exence collection creates a natural, welcoming, and refined atmosphere for interior designs with a metropolitan inspiration.

Progettata per vestire gli spazi dell'abitare con un'estetica contemporanea, la collezione Exence crea un'atmosfera naturale, accogliente e ricercata, dedicata a progetti di interni d'ispirazione metropolitana.

Conçue pour revêtir les espaces de l'habitat avec un esthétisme contemporain, la collection Exence crée une atmosphère naturelle, accueillante et raffinée, et est dédiée aux projets d'intérieur d'inspiration urbaine.

Die zur zeitgemäßen Kleidung unserer Wohnräume konzipierte Kollektion Exence erzeugt eine natürliche, einladende und stilvolle Atmosphäre. Für am Großstadtchic inspirierte Projekte.

La nueva colección de superficies Exence dedicada a proyectos interioristas de inspiración metropolitana, plasma la propia naturaleza estética vistiendo los espacios de las viviendas con las últimas tendencias de diseño y glamur vanguardista, generando atmósferas naturales y acogedoras.

Современная по дизайну коллекция Exence задумана для стильного оформления жилых интерьеров в урбанистическом стиле и создания в них натуральной, уютной, изысканной атмосферы.

OVERVIEW >

IMAGE GALLERY >

SURFACE RANGE & TECHNICAL SPECS. >

WE CARE >

A fascination with wood.



© Ceramiche Atlas Concorde

Exence features the natural look of Italian oak, strictly faithful to the colors and shades of the original material. The Saw Cut look brings out the earthiness and aged appearance of wood marked by the passage of the saw blade.

Exence vede protagonista l'effetto rovere italiano, in versione naturale, estremamente rigoroso e fedele alle cromie e alle sfumature dell'essenza originale; Saw Cut, capace di esprimere forte matericità e restituire l'aspetto vissuto del legno con i segni irregolari lasciati dalla lavorazione, "taglio sega".

Le protagoniste d'Exence est l'effet chêne italien, en version naturelle, extrêmement rigoureux et fidèle aux teintes et aux nuances de l'essence originale, tandis que Saw Cut, capable de traduire la puissance de la matière, offre l'aspect usé du bois avec les signes irréguliers laissés par l'usinage en "dents de scie".

Im Mittelpunkt von Exence steht die italienische Eiche in ihrer ganzen Natürlichkeit, deren originale Farben und Nuancen extrem detailgetreu nachempfunden sind. Die Ausführung Saw Cut bringt mit dem „gelebten“ Aussehen des Holzes und den unregelmäßigen Spuren der Sägebearbeitung die Besonderheit des Materials perfekt und intensiv zum Ausdruck.

Con la serie Exence cobra protagonismo la imitación madera roble italiana, en la versión natural, extremadamente rigurosa y fiel a las cromías y gradaciones de la materia original; Saw Cut, expresa una fuerte matericidad y elegancia restituyendo de forma realista el aspecto desgastado de la madera con las irregularidades dejadas por la elaboración "corte de sierra".

Exence предлагает рисунок натуральной древесины итальянского дуба, который с невероятной точностью передает все цвета и оттенки исходного природного материала. Поверхность Saw Cut имеет выраженную фактурность и приятный состаренный вид с неровностями, оставленными распилом.



© Ceramiche Atlas Concorde



© Ceramiche Atlas Concorde

Contemporary elegance.



© Ceramiche Atlas Concorde



© Ceramiche Atlas Concorde

Strong aesthetic appeal of the wood effect. Simple look. Warm shades inspired by the essence of oak. These are some of the traits that distinguish the Exence collection, which will create contemporary environments that recall the traditions of another time without sacrificing elegance.

Forte appeal estetico dell'effetto legno. Look essenziale. Tonalità calde ispirate all'essenza del rovere. Sono questi alcuni tratti di stile che caratterizzano la collezione Exence, da cui nascono ambienti contemporanei all'insegna della tradizione, senza rinunciare ad eleganti suggestioni.

Grand charme esthétique de l'effet bois. Look minimaliste. Tonalités chaudes qui s'inspirent de l'essence du chêne. Ce ne sont que quelques aspects du style distinctif qui caractérisent la collection Exence, qui permet de créer des espaces contemporains sous le signe de la tradition, sans renoncer aux suggestions élégantes.

Die ganze Anziehungskraft der Holzoptik. Ein auf das Wesentliche beschränkter Look. Die warmen Farbtöne der Eiche. Das sind einige der Stilmerkmale, die die Kollektion Exence auszeichnen. Sie lässt zeitgemäße Räume entstehen, die in der Tradition verwurzelt sind, aber nicht auf elegante Akzente verzichten.

Destila la belleza estética del efecto madera. Look minimalista. Tonificaciones cálidas inspiradas en la esencia de la madera roble. Estos son algunos de los elementos de estilo que caracterizan la colección Exence, dando vida a ambientes contemporáneos fieles a la tradición sin renunciar a la elegancia, diseño y funcionalidad.

Неотразимая привлекательность рисунка дерева. Благородно простой вид. Теплые тона дуба. Именно эти особенности коллекции Exence помогают создать стильные современные интерьеры, в которых ощущается приятное звучание традиций и изысканная элегантная нота.



© Ceramiche Atlas Concorde

OVERVIEW >

IMAGE GALLERY >

SURFACE RANGE & TECHNICAL SPECS. >

WE CARE >

Filled with light.



© Ceramiche Atlas Concorde



© Ceramiche Atlas Concorde



© Ceramiche Atlas Concorde

Exence features surfaces where linear or complex patterns in a soft color palette convey an accent of unmistakable style that matches the character of luminous architectural spaces designed to maximize comfort and hospitality.

Exence dà vita a superfici dove l'equilibrio, tra pattern lineari o più articolati con morbidi cromatismi, dona un accento di stile inconfondibile che ben corrisponde al carattere di spazi architettonici luminosi, improntati su concetti di comfort e di accoglienza.

Exence donne naissance à des surfaces où l'équilibre, entre des motifs linéaires ou des motifs plus articulés aux chromatismes délicats, confère une touche de style unique qui correspond bien au caractère d'espaces architecturaux lumineux fondés sur des concepts de confort et d'hospitalité.

Exence gestaltet Flächen, in denen das ausgewogene Verhältnis zwischen geradlinigen oder komplexeren Mustern und weichen Farben einen unverwechselbaren Stil prägt, der perfekt zu hellen, weiten Bauvolumen passt, in denen Komfort und Behaglichkeit ganz groß geschrieben werden.

La colección Exence da vida a superficies en las que el equilibrio, entre pattern lineales o articulados con suaves cromatismos, aporta un toque de glamur inconfundible que se ajustan al carácter de espacios arquitectónicos dinámicos y luminosos, basados en los conceptos de confort y de hospitalidad.

На поверхностях Exence гармонично сплетаются мягкие цвета и натуральные рисунки древесины – то простые, то более сложные. Все это становится стильным акцентом светлых, уютных, гостеприимных архитектурных пространств.

OVERVIEW >

IMAGE
GALLERY >SURFACE
RANGE &
TECHNICAL
SPECS. >

WE CARE >



© Ceramiche Atlas Concorde

A smooth and safe effect.



© Ceramiche Atlas Concorde



© Ceramiche Atlas Concorde

Continuous technological research in Atlas Concorde's laboratories has led to the development of SENSITECH, a new surface with technology patented in Italy that combines technical characteristics with a pleasant touch. The surface is also extremely easy to clean and acts as a barrier against dirt.

La continua ricerca tecnologica dei laboratori Atlas Concorde ha portato allo sviluppo di SENSITECH, una nuova superficie, con tecnologia brevettata in Italia, che coniuga caratteristiche tecniche a una percezione tattile piacevole. Quest'ultima si traduce in una estrema facilità di pulizia e barriera contro lo sporco.

La recherche technologique continue des laboratoires Atlas Concorde a conduit au développement de SENSITECH, une nouvelle surface, dont la technologie a été brevetée en Italie, qui conjugue des caractéristiques techniques à une agréable perception tactile. Cette dernière se traduit en une extrême facilité d'entretien et en barrière contre les salissures.

Aus der kontinuierlichen Technologieforschung der Atlas Concorde-Labore kommt SENSITECH, eine neue Oberfläche mit in Italien patentierter Technologie, die technische Vorzüge mit einer angenehmen Haptik vereint. Weitere Vorteile sind die einfache Reinigung und eine wirkungsvolle Barriere gegen Schmutz.

La continua investigación tecnológica de los laboratorios de Atlas Concorde ha permitido desarrollar SENSITECH una nueva superficie con tecnología patentada en Italia, que combina características técnicas con una agradable percepción táctil. Esto da como resultado una extrema facilidad de limpieza y barrera contra la suciedad.

Непрерывные исследования лаборатории Atlas Concorde привели к созданию SENSITECH – новой поверхности, которая будет изготавливаться по запатентованной в Италии технологии и сочетает высокие технические характеристики с удивительной приятностью на ощупь. Кроме того, она не впитывает грязь и очень проста в уходе.





Image Gallery

Living & Dining - Exence Almond



SPA - Exence Amber



Showroom - Exence Vanilla



Outdoor - Exence Almond



OVERVIEW >

IMAGE GALLERY >

LIVING & DINING > Exence Almond

SPA > Exence Amber

SHOWROOM > Exence Vanilla

OUTDOOR > Exence Almond

SURFACE RANGE & TECHNICAL SPECS. >

WE CARE >

LIVING & DINING

Expressing authenticity.

With a texture that faithfully reflects oak's natural qualities, Exence fully expresses the authenticity of the natural wood. Available in the Almond shade, it creates a warm and welcoming atmosphere in harmony with domestic interiors inspired by easy living.

Con una texture che riprende fedelmente le caratteristiche del rovere, Exence esprime appieno l'autenticità dell'essenza naturale. Declinata nella tonalità Almond, crea un'atmosfera calda e accogliente, in armonia con interni domestici ispirati all'easy living.

Grâce à sa texture qui reprend fidèlement les caractéristiques du chêne, Exence exprime pleinement l'authenticité de l'essence naturelle. Déclinée dans la tonalité Almond, elle crée une ambiance chaude et accueillante, en harmonie avec l'intérieur domestique qui s'inspire de l'easy living.

Die Strukturierung von Exence gibt die Besonderheiten der Eiche detailgetreu wieder und bringt damit die Authentizität der natürlichen Materie voll zum Ausdruck. Der Farbton Almond sorgt für eine warme und behagliche Atmosphäre, die ganz einer im Zeichen des Easy Living stehenden Wohnung entspricht.

Con una textura que emula fielmente las características del roble, la colección Exence rescata toda su autenticidad y encanto de la esencia natural. Propuesta en el color Almond, crea una atmósfera cálida y acogedora en armonía con el interiorismo de viviendas inspiradas en "easy living".

Поверхность плиток Exence удивительно точно передает эстетические характеристики натуральной древесины дуба и дарит то же ощущение аутентичности. Цвет Almond рождает в доме теплую, излучающую радость атмосферу.



© Ceramiche Atlas Concorde

FLOOR
Exence **Almond**
Matte/Matt Sensitech
18,5x150 cm | 7/16" x 59"

Exence **Almond**
Grip
18,5x150 cm | 7/16" x 59"

WALL
Boost **White**
Matte/Matt 6 mm
120x278 cm | 47/16" x 109/16"

OVERVIEW >

IMAGE
GALLERY >LIVING & DINING
> Exence AlmondSPA
> Exence AmberSHOWROOM
> Exence VanillaOUTDOOR
> Exence AlmondSURFACE
RANGE &
TECHNICAL
SPECS. >

WE CARE >

FLOOR

Exence **Almond**
Matte/Matt Sensitech
18,5x150 cm | 7¹/₄"x59"

Exence **Almond Chevron**
Matte/Matt
32,5x45 cm | 12³/₄"x17³/₄"



© Ceramiche Atlas Concorde

Included in the collection's selection of decorative pieces, Chevron is a great classic for those wanting a herringbone installation. The design – a contemporary interpretation of traditional vintage floors – makes it possible to produce dynamic, captivating patterns.

Tra le proposte dell'apparato decorativo della collezione, Chevron rappresenta un grande classico della posa a spina di pesce. Con il suo disegno, che reinterpreta in chiave contemporanea quello dei pavimenti d'epoca tradizionale, compone pattern dinamici, che catturano lo sguardo.

Parmi les propositions du système décoratif de la collection, Chevron représente un grand classique de la pose en forme de V. Son dessin réinterprète les sols traditionnels d'époque en clé contemporaine et crée des motifs dynamiques qui captent le regard.

Eines der Dekore der Kollektion ist Chevron, ein großer Klassiker des Fischgrätmotivs. Mit seinem Muster, einer zeitgemäßen Neuinterpretation des Motivs traditioneller Bodenbeläge, entstehen dynamische Effekte, die als Blickfang dienen.

Entre las propuestas decorativas de la colección, Chevron representa un gran clásico de la colocación en espina de pez. Con su movimiento gráfico que interpreta en clave moderna el pavimento de época tradicional, compone pattern dinámicos que atrapan la mirada.

Декор Chevron, включенный в гамму декоративных элементов коллекции, предназначен для елочной схемы укладки, давно ставшей классикой. Получаемый рисунок пересматривает в современном ключе старые традиционные полы, привлекая взгляд стильным динамизмом.



© Ceramiche Atlas Concorde

INDEX



OVERVIEW

IMAGE
GALLERYLIVING & DINING
> Exence AlmondSPA
> Exence AmberSHOWROOM
> Exence VanillaOUTDOOR
> Exence AlmondSURFACE
RANGE &
TECHNICAL
SPECS.

WE CARE



In the Saw Cut version, Exence boosts the natural character of the wall tile by replicating the uneven effect of traditional cuts made from a blade. The open space of the dining environment is enhanced by the evocative relationship between light and the soft nuances of the Almond color variant.

Nella versione Saw Cut, Exence accentua la naturalità del rivestimento, restituendo l'effetto irregolare della lavorazione tradizionale a "taglio sega". L'open space dell'ambiente dining è valorizzato dal rapporto evocativo tra la luce e le morbide sfumature della variante colore Almond.

In der Version Saw Cut unterstreicht Exence die Natürlichkeit des Wandbelags durch die traditionell anmutende und wie gesägt aussehende unregelmäßige Optik. Der offene Essbereich kommt durch den Dialog zwischen dem Licht und den weichen Nuancen der Farbvariante Almond besonders gut zur Geltung.

Dans la version Saw Cut, Exence accentue l'inspiration naturelle du revêtement qui reproduit l'effet irrégulier de l'usinage traditionnel en "dents de scie". L'open space du dining est valorisé par le rapport entre la lumière et les nuances délicates de la teinte Almond.

La colección Exence en la versión Saw Cut intensifica la naturalidad del revestimiento, restituyendo el efecto irregular de la elaboración tradicional "corte de sierra". El open space del ambiente dining está valorizado por la relación entre la luz y los matices esfumados del color Almond.

В варианте поверхности Saw Cut коллекция Exence передает неровности, остающиеся на древесине после распила. Эффект простора в столовой комнате усилен изобилием света и мягкими оттенками цвета Almond.

FLOOR
Exence **Almond Saw Cut**
Matte/Matt Sensitech
18,5x150 cm | 7¹/₄"x59"

WALL
Exence **Almond Tatami**
Matte/Matt
18,5x75 cm | 7¹/₄"x29¹/₂"

FURNITURE
AtlasPlan Boost **Smoke**
Hammered
162x324 cm | 63³/₄"x127¹/₂"



© Ceramiche Atlas Concorde

OVERVIEW

IMAGE
GALLERYLIVING & DINING
> Exence AlmondSPA
> Exence AmberSHOWROOM
> Exence VanillaOUTDOOR
> Exence AlmondSURFACE
RANGE &
TECHNICAL
SPECS.

WE CARE



© Ceramiche Atlas Concorde



FLOOR
 Exence Almond Saw Cut
 Matte/Matt Sensitech
 18,5x150 cm | 7/8" x 59"

WALL
 Exence Almond Tatami
 Matte/Matt
 18,5x75 cm | 7/8" x 29 1/2"

FURNITURE
 AtlasPlan Boost Smoke
 Hammered
 162x324 cm | 63 3/4" x 127 1/2"

OVERVIEW >

IMAGE GALLERY >

LIVING & DINING
> Exence Almond

SPA
> Exence Amber

SHOWROOM
> Exence Vanilla

OUTDOOR
> Exence Almond

SURFACE RANGE & TECHNICAL SPECS. >

WE CARE >

FLOOR	WALL	FURNITURE
Exence Almond Saw Cut	Exence Almond Tatami	AtlasPlan Boost Smoke
Matte/Matt Sensitech	Matte/Matt	Hammered
18,5x150 cm 7 ¹ / ₄ "x59"	18,5x75 cm 7 ¹ / ₄ "x29 ¹ / ₂ "	162x324 cm 63 ³ / ₄ "x127 ¹ / ₂ "



© Ceramiche Atlas Concorde

The Tatami decoration is particularly versatile, suitable for use even on curved surfaces.

Particolarmente versatile nelle sue applicazioni è il decoro Tatami, adatto anche a rivestire le superfici curve.

Particulièrement éclectique dans toutes ses applications, le décor Tatami est également adapté pour revêtir des surfaces arrondies.

Das Dekor Tatami, das sich auch zur Verkleidung gekrümmter Flächen eignet, ist ganz besonders vielseitig.

La decoración Tatami es decididamente versátil en sus aplicaciones, además indicado para vestir las superficies curvas.

Декоративный элемент Tatami необыкновенно функционален и подходит также для покрытия изогнутых поверхностей.

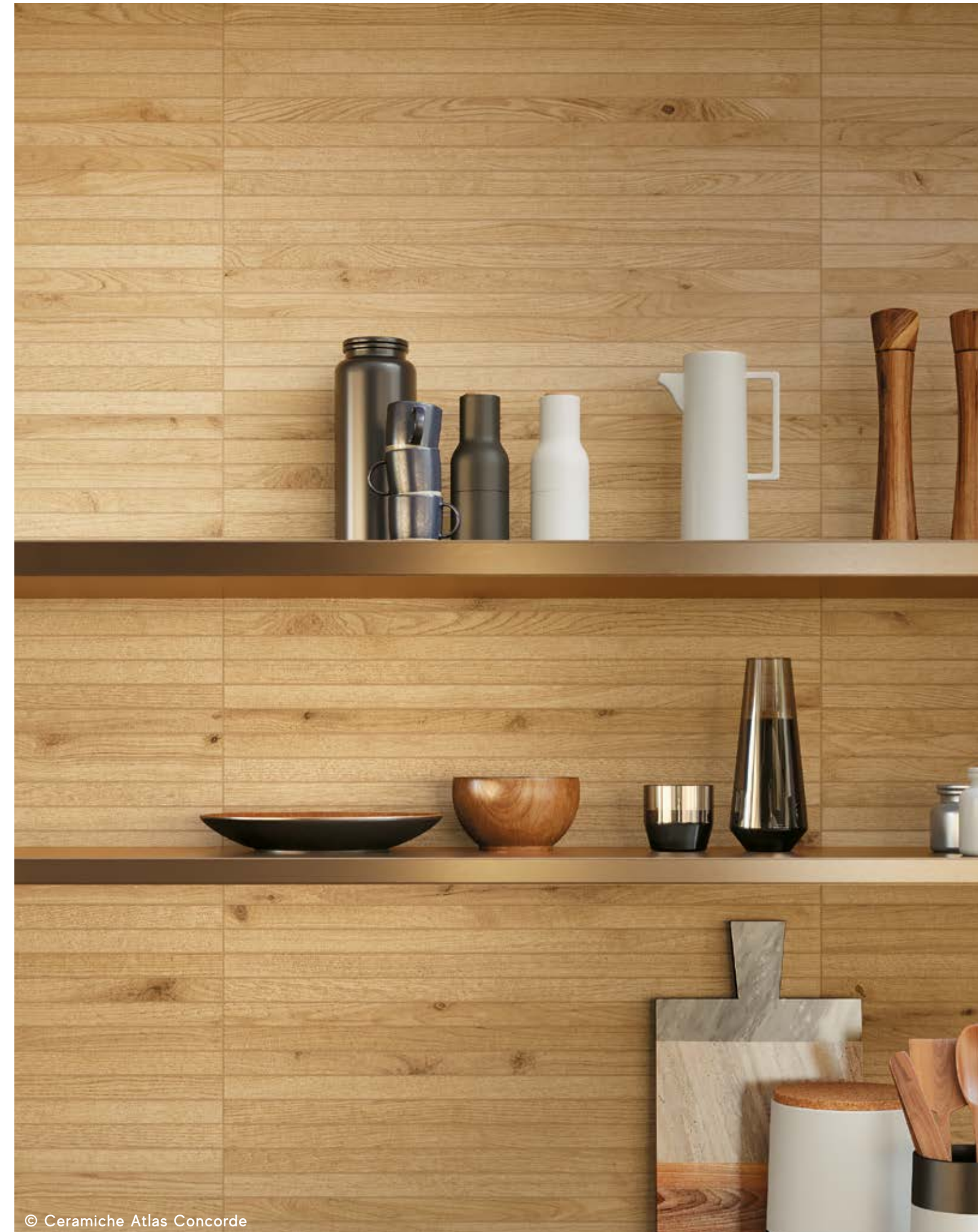

© Ceramiche Atlas Concorde

SPA

Wellness reloaded.

Natural wood – which in Nordic tradition defines environments dedicated to taking care of oneself – was the inspiration for wellness spaces promoting harmony of the body and spirit. The Saw Cut version of Exence Amber accentuates the natural character of the effect and the irregularity of the texture.

Dal legno naturale, che nella tradizione nordica definisce gli spazi dedicati alla cura del sé, è nata l'ispirazione per progettare ambienti wellness dove ritrovare l'armonia tra corpo e spirito. La versione Saw Cut di Exence Amber accentua la naturalità dell'effetto con l'irregolarità della texture.

C'est à partir du bois naturel, qui dans la tradition nordique définit les espaces dédiés au bien-être, qu'est née l'inspiration pour concevoir des espaces où retrouver l'harmonie entre le corps et l'esprit. La version Saw Cut d'Exence Amber accentue le naturel de l'effet avec l'irrégularité de la texture.

Vom Naturholz, das in der Tradition des Nordens von jeher Räume wie Saunas und Bäder kleidet, stammt die Inspiration für Wellness-Räume, in denen wir die Harmonie zwischen Körper und Geist wiederfinden. Die Version Saw Cut von Exence Amber akzentuiert die natürliche Wirkung durch ihre unregelmäßige Struktur.

En la tradición nórdica los espacios dedicados al cuidado del cuerpo están diseñados a partir de la madera natural, materia inspiradora de proyectos que confieren pureza y autenticidad a estancias dedicadas al bienestar, portadoras de armonía entre el cuerpo y el espíritu. La versión Saw Cut de Exence Amber intensifica la naturaleza del efecto con las irregularidades de la textura.

Традиционно в скандинавских странах основным материалом для отделки помещений, отведенных для ухода за собой, является натуральное дерево. Его имитацию мы использовали в оформлении современного велнес-пространства, помогающего приятно восстановить гармонию души и тела. Поверхность Saw Cut цвета Amber подчеркивает натуральность рисунка естественной неровностью фактуры.

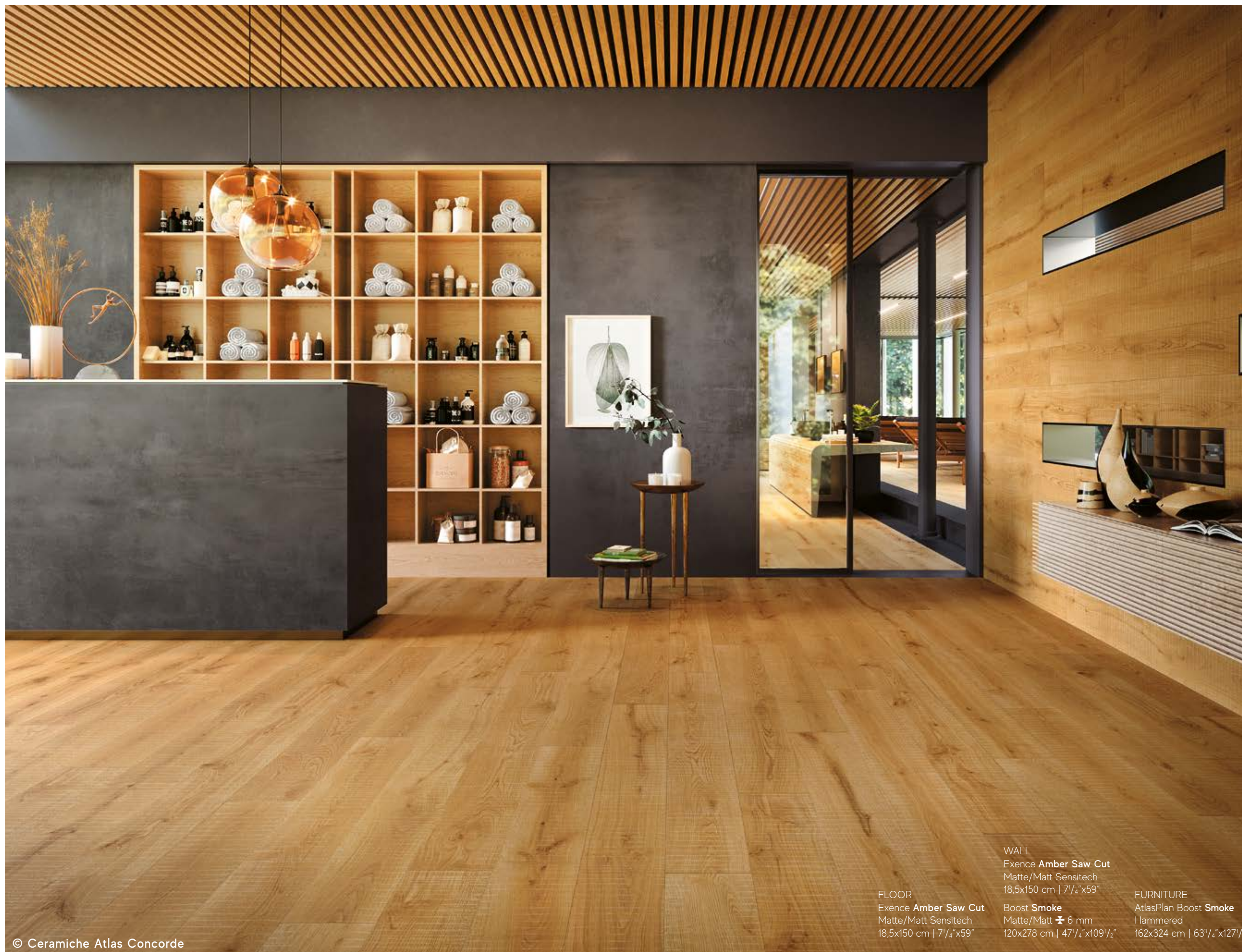

© Ceramiche Atlas Concorde

FLOOR
Exence Amber Saw Cut
Matte/Matt Sensitech
18,5x150 cm | 7¹/₄"x59"

WALL
Exence Amber Saw Cut
Matte/Matt Sensitech
18,5x150 cm | 7¹/₄"x59"

Boost Smoke
AtlasPlan Boost Smoke
Matte/Matt 6 mm
120x278 cm | 47¹/₄"x109¹/₂"

FURNITURE
AtlasPlan Boost Smoke
Hammered
162x324 cm | 63³/₄"x127¹/₂"

OVERVIEW >

IMAGE GALLERY >

LIVING & DINING
> Exence AlmondSPA
> Exence AmberSHOWROOM
> Exence VanillaOUTDOOR
> Exence Almond

SURFACE RANGE & TECHNICAL SPECS. >

WE CARE >



FLOOR
 Exence **Amber Saw Cut**
 Matte/Matt Sensitech
 18,5x150 cm | 7 1/4" x 59"

WALL
 Exence **Amber Saw Cut**
 Matte/Matt Sensitech
 18,5x150 cm | 7 1/4" x 59"

Boost **Smoke**
 Matte/Matt
 120x278 cm | 47 1/4" x 109 1/2" ✕ 6 mm

FURNITURE
 AtlasPlan Boost **Smoke**
 Hammered
 162x324 cm | 63 3/4" x 127 1/2"

	WALL	
	Exence Amber Saw Cut	
	Matte/Matt Sensitech	
	18,5x150 cm 7 ¹ / ₄ "x59"	
FLOOR		FURNITURE
Exence Amber	AtlasPlan Boost Smoke	Exence Amber Tatami
Grip	Hammered	Matte/Matt
18,5x150 cm 7 ¹ / ₄ "x59"	162x324 cm 63 ³ / ₄ "x127 ¹ / ₂ "	18,5x75 cm 7 ¹ / ₄ "x29 ¹ / ₂ "



© Ceramiche Atlas Concorde



© Ceramiche Atlas Concorde

The warm tones of the Amber shade create a relaxing and welcoming ambiance in the spa area, defined by a simple design. The non-slip finish was specifically designed for wet environments.

I toni caldi della variante cromatica Amber creano un'atmosfera rilassante e accogliente nell'area spa, definita da un design essenziale. La finitura grip antiscivolo è stata studiata appositamente per gli ambienti umidi.

Les tons chauds de la variante chromatique Amber créent une atmosphère accueillante et relaxante dans le spa qui est défini par un design minimaliste. La finition antiglisse a été spécialement étudiée pour les lieux humides.

Die warmen Nuancen der Farbvariante Amber erzeugen eine entspannte, behagliche Atmosphäre in dem von schlichtem Design geprägten Spa-Bereich. Die rutschfeste Oberfläche wurde eigens für feuchte Bereiche entwickelt.

Las zonas spa están definidas por un diseño de estética minimalista gracias a los tonos cálidos de la variante cromática Amber, generando atmósferas relajantes y acogedoras. La rugosidad del acabado grip de alta resistencia al deslizamiento se ha estudiado expresamente para las zonas húmedas.

Теплые тона цвета Amber рождют в лаконичном по дизайну СПА-интерьере релаксирующую атмосферу. Противоскользящая поверхность Grip разработана специально для влажных пространств.

FLOOR

Exence **Amber**
Grip
18,5x150 cm | 7¹/₄"x59"

WALL

Exence **Amber Square**
Matte/Matt
56,1x56,1 cm | 22"x22"
AtlasPlan Boost **Smoke**
Hammered
162x324 cm | 63³/₄"x127¹/₂"

FURNITURE

Exence **Amber Tatami**
Matte/Matt
18,5x75 cm | 7¹/₄"x29¹/₂"



© Ceramiche Atlas Concorde

OVERVIEW

IMAGE
GALLERYLIVING & DINING
> Exence AlmondSPA
> Exence AmberSHOWROOM
> Exence VanillaOUTDOOR
> Exence AlmondSURFACE
RANGE &
TECHNICAL
SPECS.

WE CARE



	WALL	
	Exence Amber Square	
	Matte/Matt	
	56,1x56,1 cm 22"x22"	
FLOOR		FURNITURE
Exence Amber	AtlasPlan Boost Smoke	Exence Amber Tatami
Grip	Hammered	Matte/Matt
18,5x150 cm 7 ¹ / ₄ "x59"	162x324 cm 63 ³ / ₄ "x127 ¹ / ₂ "	18,5x75 cm 7 ¹ / ₄ "x29 ¹ / ₂ "

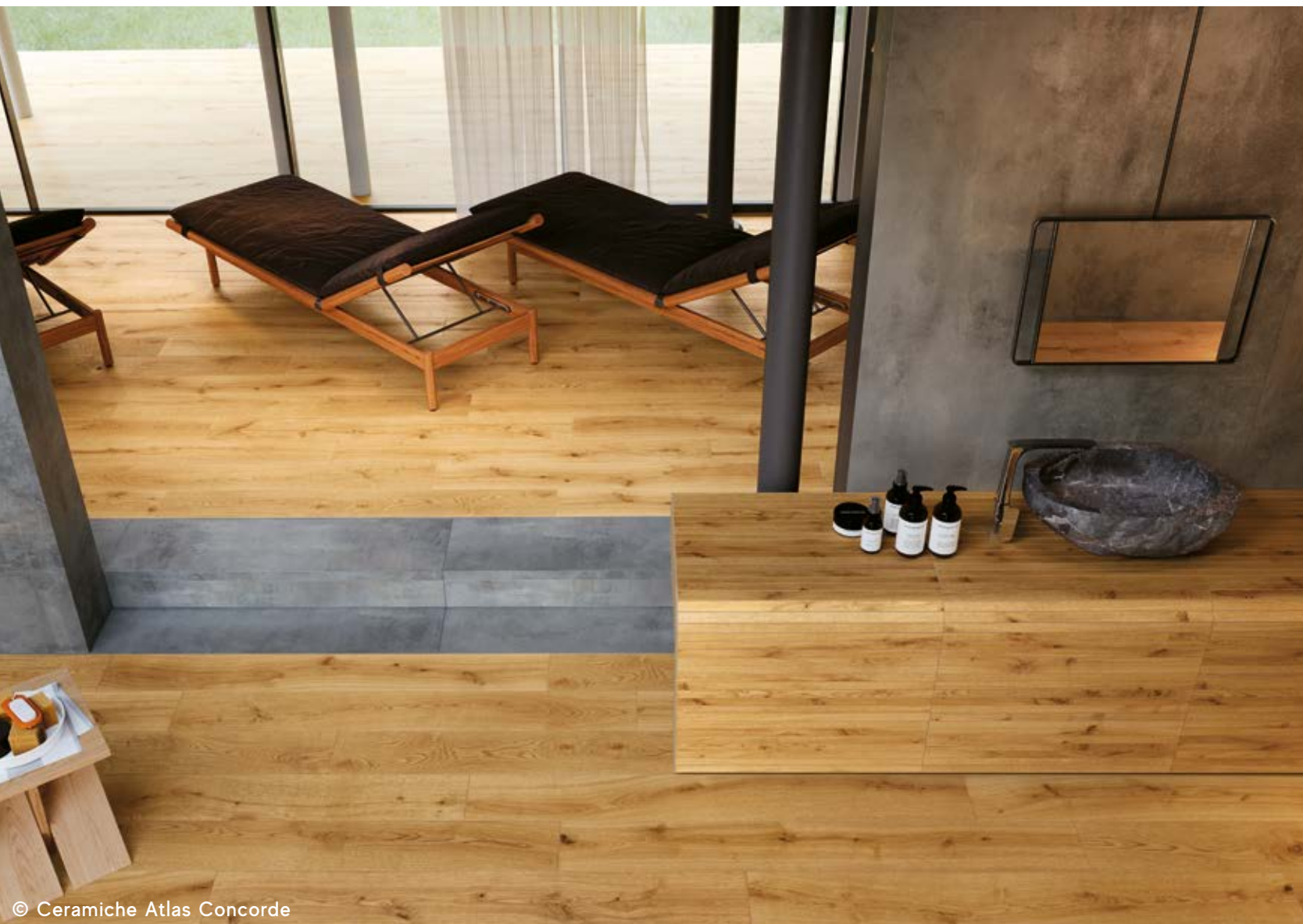

© Ceramiche Atlas Concorde

One of the interesting decorations in the Exence collection is Square, designed as a tangram composed of unconventional geometric shapes that play with broken lines. An ideal solution to add movement to the surface and the interior design.

Una variante interessante di decoro della collezione Exence è Square, disegnato come un tangram composto da figure geometriche non convenzionali che giocano con linee spezzate. Una soluzione ideale per dare movimento alla superficie e agli interni.

Une variante intéressante du décor de la collection Exence est Square, dessiné comme un tangram composé de figures géométriques non conventionnelles qui jouent avec des lignes brisées. Une solution idéale pour donner du mouvement à la surface et aux intérieurs.

Eine besonders interessante Dekoridee der Kollektion Exence ist Square. Es wirkt wie ein Tangram aus ungewohnten geometrischen Figuren, die mit durchbrochenen Linien spielen. Eine ideale Lösung, um Flächen und Innenräumen Bewegung zu verleihen.

La colección Exence incorpora una variante sugestiva de decoración; es Square, diseñada como un tangram compuesto por figuras geométricas no convencionales que juegan con líneas partidas. Una solución indicada para aportar dinamismo sorprendente a la superficie y a los interiores.

Интересным вариантом декоративного элемента коллекции Exence является Square. Он подобен танграму, чьи геометрические фигуры рожают оригинальный рисунок из ломаных линий. Идеальное решение для придания поверхностям и интерьерам выразительного динамизма.

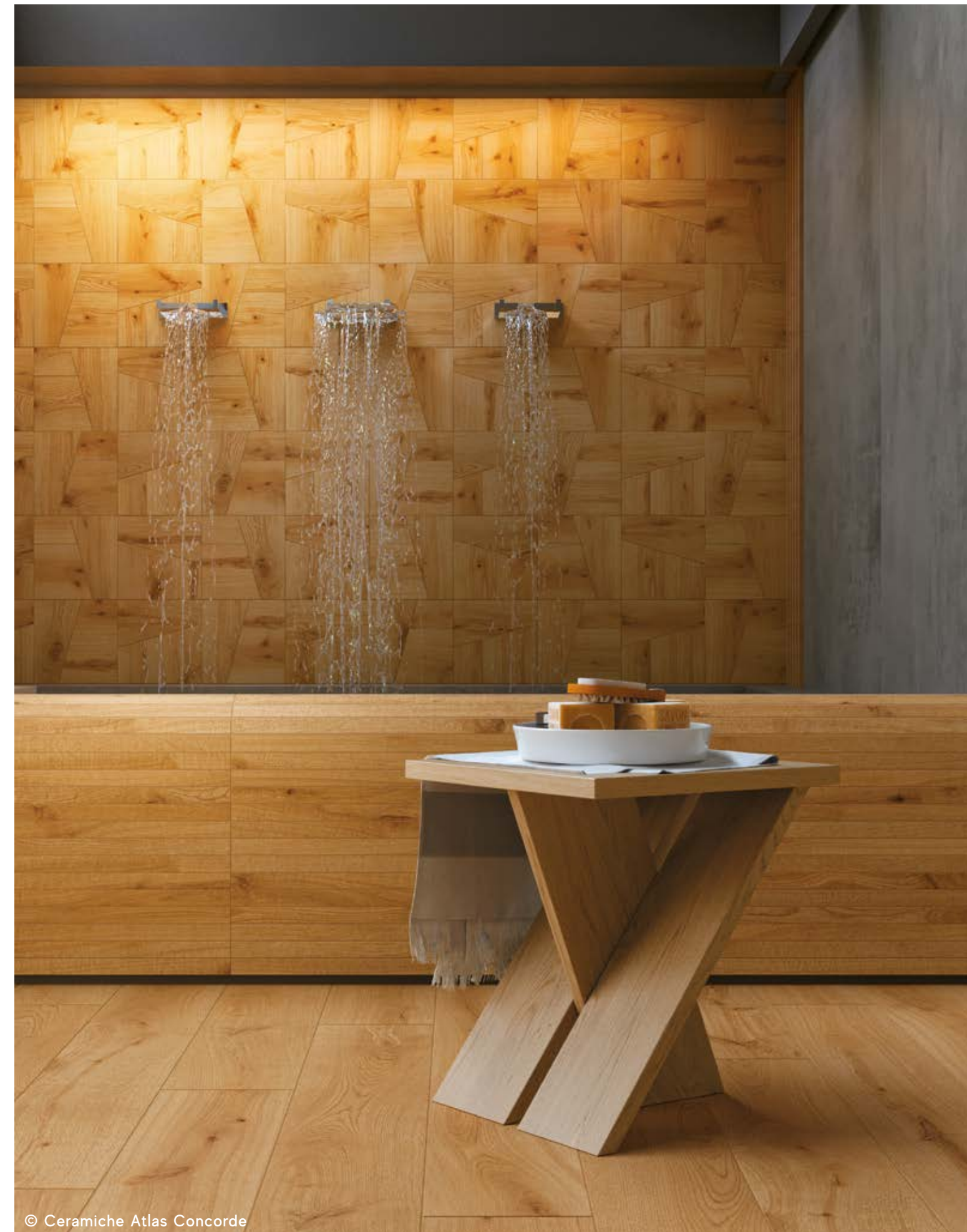

© Ceramiche Atlas Concorde

SHOWROOM

Welcoming spaces.

The look of oak creates a friendly and comfortable atmosphere in new commercial spaces. Thanks to its elegance and authenticity, the Exence collection also adds a domestic dimension to spaces dedicated to the community.

L'estetica dei roveri crea un'atmosfera amichevole e confortevole nei nuovi spazi commerciali. Grazie alla sua eleganza ed autenticità, la collezione Exence conferisce una dimensione domestica anche ai luoghi dedicati alla collettività.

L'esthétisme des essences de chêne crée une atmosphère conviviale et confortable dans les nouveaux espaces commerciaux. Grâce à son élégance et à son authenticité, la collection Exence confère une dimension domestique même aux lieux dédiés à la collectivité.

Die Eichenoptik erzeugt in modernen, gewerblich genutzten Räumen eine freundliche und angenehme Atmosphäre. Mit ihrer Eleganz und Authentizität verleiht die Kollektion Exence auch Orten des öffentlichen Lebens eine häusliche Dimension.

La estética de los robles generan atmósferas encantadoras y confortables en los nuevos espacios comerciales. Gracias a su elegancia y autenticidad, la colección Exence otorga un matiz doméstico a los lugares dedicados a la colectividad.

Рисунок древесины дуба создает в коммерческих пространствах комфортную неформальную обстановку. Благодаря естественной элегантности коллекции Exence даже общественные интерьеры приобретают домашнюю теплоту.



© Ceramiche Atlas Concorde

FLOOR
Exence **Vanilla**
Matte/Matt Sensitech
18,5x150 cm | 7¹/₄"x59"

WALL
Boost **Smoke**
Matte/Matt
120x278 cm | 47¹/₄"x109¹/₂"

FURNITURE
Exence **Vanilla Saw Cut**
Matte/Matt Sensitech
18,5x150 cm | 7¹/₄"x59"

OVERVIEW >

IMAGE GALLERY >

LIVING & DINING
> Exence AlmondSPA
> Exence AmberSHOWROOM
> Exence VanillaOUTDOOR
> Exence Almond

SURFACE RANGE & TECHNICAL SPECS. >

WE CARE >



© Ceramiche Atlas Concorde



© Ceramiche Atlas Concorde

FLOOR
 Exence **Vanilla**
 Matte/Matt Sensitech
 18,5x150 cm | 7¹/₄"x59"

WALL
 Boost **Smoke**
 Matte/Matt
 120x278 cm | 47¹/₄"x109¹/₂"

FURNITURE
 Exence **Vanilla Saw Cut**
 Matte/Matt Sensitech
 18,5x150 cm | 7¹/₄"x59"

LIVING & DINING

> Exence Almond

SPA

> Exence Amber

SHOWROOM

> Exence Vanilla

OUTDOOR

> Exence Almond

SURFACE RANGE & TECHNICAL SPECS.

FLOOR

Exence **Vanilla**
Matte/Matt Sensitech
18,5x150 cm | 7¹/₄"x59"

Exence **Vanilla Saw Cut**
Matte/Matt Sensitech
18,5x150 cm | 7¹/₄"x59"

WALL

Boost **Smoke**

Matte/Matt
120x278 cm | 47¹/₄"x109¹/₂"



© Ceramiche Atlas Concorde

With its irregular grooves typical of the saw cuts, Exence Vanilla Saw Cut adds character and personality to interiors. Perfect for showrooms distinguished by formal simplicity and a clean look.

Con le sue scanalature irregolari, tipiche della lavorazione "taglio sega", Exence Vanilla Saw Cut aggiunge carattere e personalità agli interni. Perfetto per connotare showroom improntati alla semplicità formale e a un design essenziale.

Avec ses stries irrégulières, typiques de l'usinage en "dents de scie", Exence Vanilla Saw Cut donne du caractère et une forte personnalité à tous les intérieurs. Une surface parfaite pour caractériser les showrooms qui, à la simplicité des formes, veulent allier un design minimaliste.

Mit seinen für die „Sägeschnitt-Optik“ typischen, unregelmäßigen Rillen bringt Exence Vanilla Saw Cut Charakter und Persönlichkeit in den Raum. Einfach perfekt für die Gestaltung von Showrooms, die von formaler Schlichtheit und einem klaren Design geprägt sind.

Con el veteadado irregular y refinado típico de la elaboración "corte de sierra", la colección Exence Vanilla Saw Cut añade carácter y personalidad a las estancias. Indicada para definir salas de exposición que conlleven la simplicidad y encanto y en un diseño minimalista.

Своими неравномерными, характерными для пиленной древесины бороздками Exence Vanilla Saw Cut придает интерьеру пленительную индивидуальность. Коллекция идеальна для шоу-румов, в которых доминирует простота форм и лаконичный дизайн.



© Ceramiche Atlas Concorde

OUTDOOR

A pool with a view.



© Ceramiche Atlas Concorde

FLOOR

Exence **Almond**

Outdoor ∇ 20 mm
30x120 cm | 11³/₄"x47¹/₄"

Exence **Almond Round**
Outdoor ∇ 20 mm
30x120 cm | 11³/₄"x47¹/₄"

Exence **Almond Alzata**

Outdoor ∇ 20 mm
30x120 cm | 11³/₄"x47¹/₄"

Exence **Almond Round Ang. Dx/Sx**
Outdoor ∇ 20 mm
30x120 cm | 11³/₄"x47¹/₄"

Boost **Grey**

Matte/Matt
120x120 cm | 47¹/₄"x47¹/₄"



© Ceramiche Atlas Concorde

OVERVIEW >

IMAGE GALLERY >

LIVING & DINING
> Exence Almond

SPA
> Exence Amber

SHOWROOM
> Exence Vanilla

OUTDOOR
> Exence Almond

SURFACE RANGE & TECHNICAL SPECS. >

WE CARE >



Surface Range & Technical Specs.

- 46 SENSITECH
- 48 PRODUCT RANGE
- 53 TECHNICAL SPECIFICATIONS

The evolution of ceramic surfaces.

ENJOY THE VIDEO
EN | IT | FR | DE | RU

DISCOVER MORE
EN | IT | FR | DE | ES | RU

The constant research of Atlas Concorde Laboratories has led to the creation of Sensitech, the porcelain tile surface made using a production method patented in Italy. Sensitech is a high-tech surface for interiors that combines high slip resistance with an unrivaled soft touch, which also makes it resistant to dirt and easier to clean. With Sensitech the meaning of surface evolves and takes on a reassuring, protective, and pleasantly refined touch, making architectural spaces increasingly comfortable and appealing.

La recherche constante des Laboratoires Atlas Concorde a créé Sensitech, la surface en grès cérame pour intérieur réalisée avec un procédé de fabrication breveté en Italie. Une surface à haut coefficient technologique pour les espaces intérieurs, en mesure de conjuguer de hautes performances de résistance à la glissance avec une douceur tactile inédite, qui la rend également résistante aux salissures et plus facile à nettoyer. Avec Sensitech, c'est l'acception même d'une surface qui évolue en offrant une caractéristique rassurante, protectrice et agréablement raffinée, qui rend les espaces architecturaux de plus en plus confortables et agréables à vivre.

De la constante investigación de los Laboratorios Atlas Concorde nace Sensitech, la superficie de gres porcelánico para interiores realizada con un método de producción patentado en Italia. Una superficie de alto coeficiente tecnológico capaz de combinar un alto rendimiento de resistencia al deslizamiento con una suavidad táctil sin precedentes, que además la vuelve resistente a la suciedad y más fácil de limpiar. Con Sensitech, el significado de la superficie evoluciona y adquiere un toque tranquilizador, protector y agradablemente refinado, haciendo que los espacios arquitectónicos sean cada vez más cómodos y satisfactorios.

Dalla costante ricerca dei Laboratori Atlas Concorde nasce Sensitech, la superficie in gres porcellanato realizzata con metodo produttivo brevettato in Italia. Una superficie ad alto coefficiente tecnologico per gli ambienti interni, in grado di coniugare elevate prestazioni di resistenza allo scivolamento ad un'inedita morbidezza tattile, che la rende anche resistente allo sporco e più facile da pulire. Con Sensitech il significato di superficie si evolve e assume un tocco rassicurante, protettivo e piacevolmente raffinato, rendendo gli spazi architettonici sempre più confortevoli ed appaganti.

Durch kontinuierliche Forschung der Atlas Concorde Laboratorien entsteht Sensitech, die Feinsteinzeugoberfläche, die mit einem in Italien patentierten Herstellungsverfahren produziert wird. Eine Hightec-Oberfläche für Innenräume, die hohe Rutschfestigkeit mit unerwartet weicher Haptik verbindet, welche sie auch schmutzunempfindlicher und reinigungsfreundlicher macht. Mit Sensitech erreicht die Oberfläche ein ganz neues Niveau in Sachen Zuverlässigkeit, Schutz und Schönheit. Und macht damit unsere Räumlichkeiten noch attraktiver und komfortabler.

В результате исследований, выполненных в лабораториях Atlas Concorde, появилась керамогранитная поверхность Sensitech. Новая поверхность с высокими техническими показателями для интерьеров, которая сочетает отличное сопротивление скольжению и удивительную мягкость на ощупь, устойчива к загрязнениям и крайне проста в чистке и уходе. Поверхность Sensitech – на новом витке технической эволюции, она безопасна, приятна, изысканна и делает пространства уютнее и удобнее.

Sensitech SAFE. SOFT. SMART.



SOFT TO THE TOUCH

MORBIDA AL TATTO



EXTREMELY SAFE

ESTREMAMENTE SICURA



HYGIENIC AND EASY TO CLEAN

IGIENICA E FACILMENTE PULIBILE



LONG-LASTING QUALITIES

QUALITÀ DUREVOLI NEL TEMPO

Surface section magnification (μm)* Ingrandimento di una sezione di superficie (μm)*

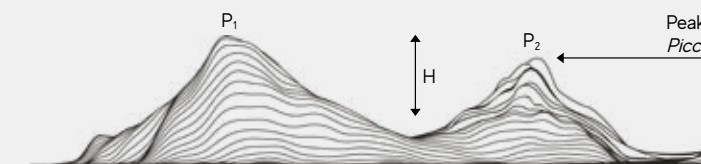

Traditional anti-slip surface
Superficie anti-slip tradizionale

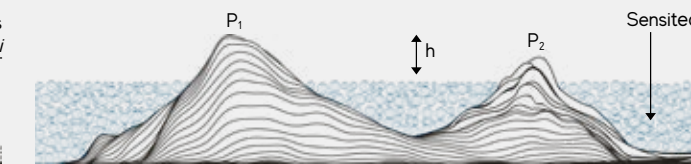

Sensitech surface
Superficie Sensitech

$P_1 P_2$ Same peaks → same slippery resistance
Picchi invariati → uguale resistenza allo scivolamento

$h < H$ Reduced depth of valleys → smoother surface and greater ease of cleaning
Minore profondità degli avvallamenti → percezione di superficie più liscia e maggiore facilità di pulizia

* Charts not to scale, for illustrative purposes / Grafici non in scala, a scopo illustrativo

EXENCE

Porcelain tiles

PORCELAIN TILES - RECTIFIED MONOCALIBER

Gres porcellanato - Rettificato monocalibro

Grès cérame - Rectifié mono-calibre / Feinsteinzeug - Geschliffen einkalibrig /

Gres porcelánico - Rectificado monocalibre / Керамический гранит - Ретифицированный в одном калибре

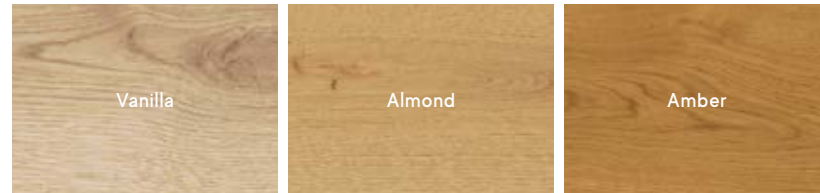

18,5x150 cm - 7 1/4" x 59"

± 9 mm

Matte Sensitech (S)

Matte Sensitech (S)

Matte Sensitech (S)

20x120 cm - 7 7/8" x 47 1/4"

± 9 mm

Matte Sensitech (S)

Matte Sensitech (S)

Matte Sensitech (S)



Outdoor and Wet Areas

18,5x150 cm - 7 1/4" x 59"

± 9 mm

Grip

Grip

Grip

30x120 cm - 11 3/4" x 47 1/4"

± 20 mm

Outdoor

Outdoor

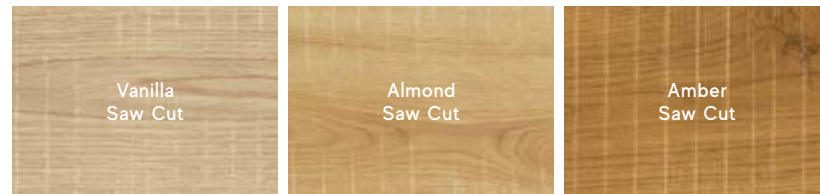

Saw Cut



18,5x150 cm - 7 1/4" x 59"

± 9 mm

Matte Sensitech (S)

Matte Sensitech (S)

Matte Sensitech (S)



The constant research of Atlas Concorde Laboratories has led to the creation of Sensitech, the porcelain tile surface for interiors made using a production method patented in Italy that combines superior slip-resistance with an unprecedented tactile softness, guaranteeing ease of cleaning and maintenance.

Dalla costante ricerca dei Laboratori Atlas Concorde nasce Sensitech, la superficie in gres porcellanato per interni realizzata con metodo produttivo brevettato in Italia, che associa elevate prestazioni di resistenza allo scivolamento ad un'inedita morbidezza tattile, garantendo facilità di pulizia e manutenzione.

Destination of use

Matte Sensitech (S) ± 9 mm
Grip ± 9 mm
Outdoor ± 20 mm

Anti-slip

R10 B Matte Sensitech (S) ± 9 mm
R11 C Grip ± 9 mm
R11 C Outdoor ± 20 mm

Color-shading

V2 Slight Variation



VANILLA

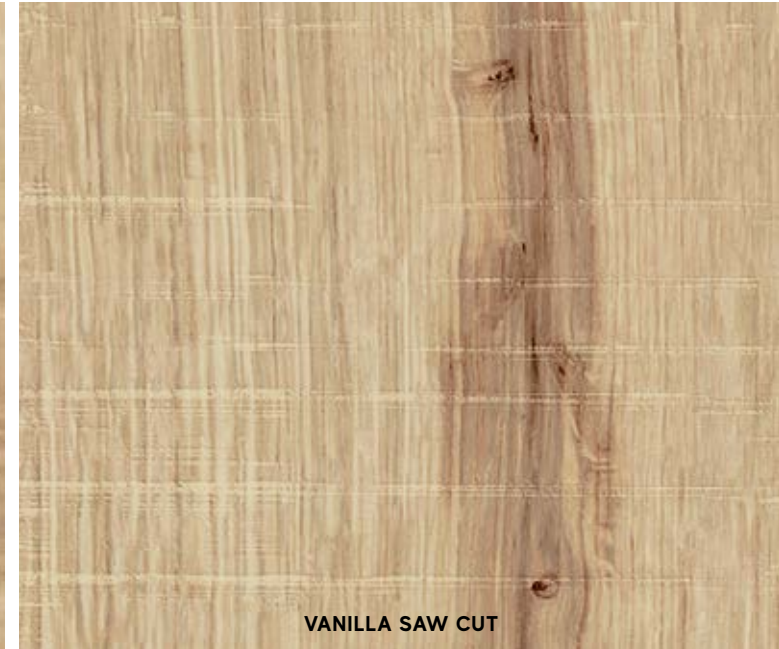

VANILLA SAW CUT



ALMOND



ALMOND SAW CUT

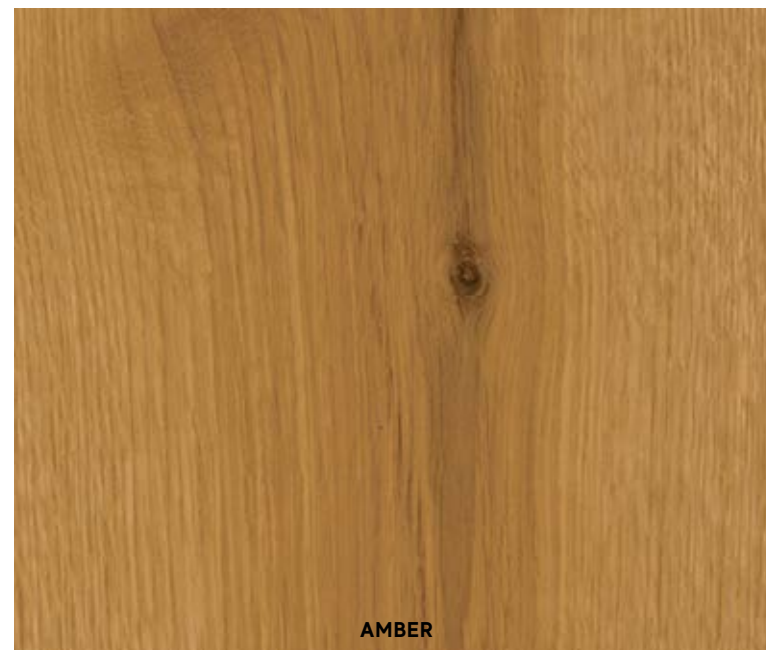

AMBER

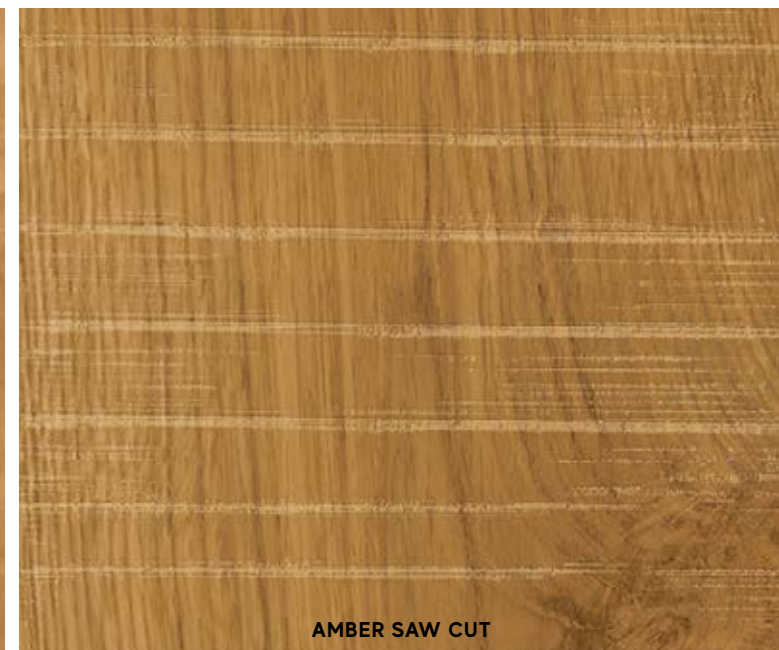

AMBER SAW CUT

EXENCE

Porcelain tiles decors



Exence Vanilla
Square
56,1x56,1 cm - 22"x22"



Exence Almond
Square
56,1x56,1 cm - 22"x22"



Exence Amber
Square
56,1x56,1 cm - 22"x22"

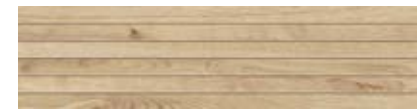
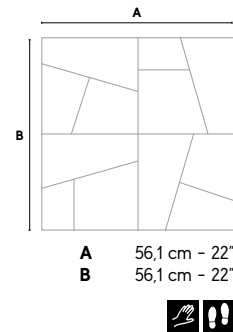

Exence Vanilla
Tatami
18,5x75 cm - 7 1/4"x29 1/2"



Exence Almond
Tatami
18,5x75 cm - 7 1/4"x29 1/2"



Exence Amber
Tatami
18,5x75 cm - 7 1/4"x29 1/2"

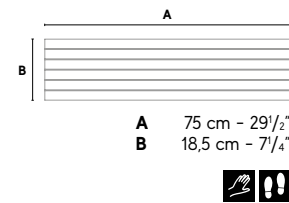

Exence Vanilla
Chevron
32,5x45 cm - 12 3/4"x17 3/4"

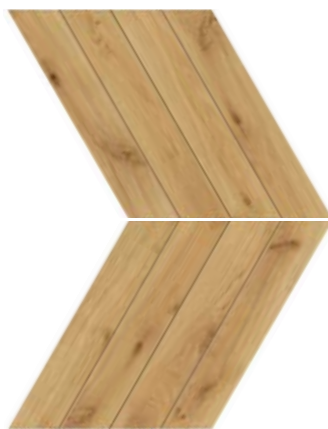

Exence Almond
Chevron
32,5x45 cm - 12 3/4"x17 3/4"



Exence Amber
Chevron
32,5x45 cm - 12 3/4"x17 3/4"

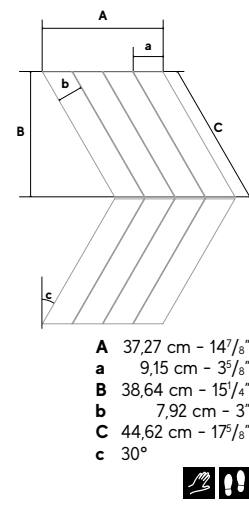

EXENCE

Trim tiles

Indoor trim tiles

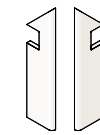
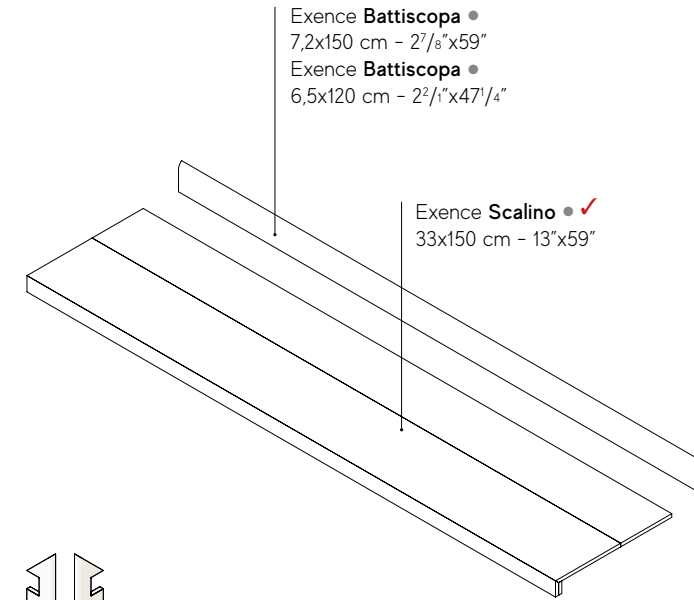

Exence **Battiscopa Sagomato Matt Sx/Dx** ● ✓
7,2x30 cm - 2 7/8"x11 3/4"

✓ These parts are supplied to order / I pezzi sono disponibili su ordinazione

Outdoor trim tiles ± 20 mm

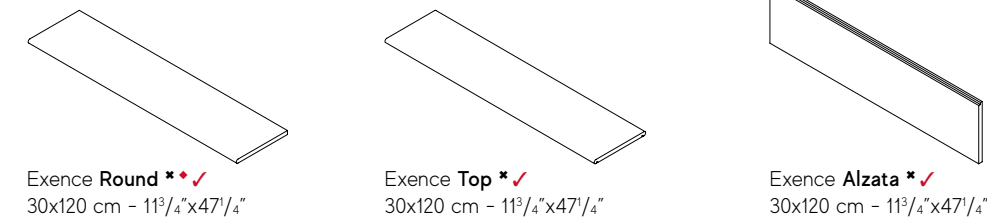

- ◆ Right/left angular elements are available / Sono disponibili gli elementi angolari dx/sx
- Available in the following colors: / Disponibile nei seguenti colori: **Vanilla, Almond, Amber**
- ✱ Available in the following colors: / Disponibile nei seguenti colori: **Almond, Amber**
- ✓ These parts are supplied to order / I pezzi sono disponibili su ordinazione

Porcelain tiles ± 20 mm

For further details on the 20mm thick products, related trim pieces and installation systems - in particular for recommendations and precautions during installation- please refer to the **Outdoor Design** section on the **Atlas Concorde website** or to the **Outdoor Design catalogue**. Per dettagli sul prodotto e sui relativi pezzi speciali in 20mm di spessore, per i sistemi di posa e, in particolare, per raccomandazioni, accorgimenti e precauzioni in fase di posa e progettazione, si raccomanda di prendere visione del catalogo Outdoor Design e della sezione Outdoor Design del sito Atlas Concorde. / Pour plus de renseignements sur le produit, les pièces spéciales de 20mm d'épaisseur et sur les systèmes de pose, ainsi que pour tous conseils et recommandations et précautions d'emploi pendant la pose ou en phase de conception, nous vous recommandons de lire le catalogue Outdoor Design et de consulter la section Outdoor Design sur le site d'Atlas Concorde. / Bitte beachten Sie die detaillierten Informationen zum Produkt und zu den zugehörigen Formteilen in 20mm Stärke, zu den Verlegesystemen sowie vor allem die Empfehlungen, Tipps und bei der Planung und Verlegung zu beachtenden Vorsichtsmaßnahmen, die im Katalog Outdoor Design sowie im Bereich Outdoor Design der Atlas Concorde-Website aufgeführt sind. / Para mayor información sobre el producto y sus relativas piezas especiales de 20mm de grosor, para los sistemas de colocación, y en particular, para las recomendaciones, cautelas y precauciones en la fase de colocación y diseño, se recomienda consultar el catálogo Outdoor Design y la sección Outdoor Design del sitio Atlas Concorde. / Подробнее о плитках и о специальных элементах толщиной 20мм, о системах монтажа, о мерах предосторожности при проектировании и укладке можно узнать в каталоге Outdoor Design и в разделе Outdoor Design на сайте Atlas Concorde.

Outdoor trim tiles

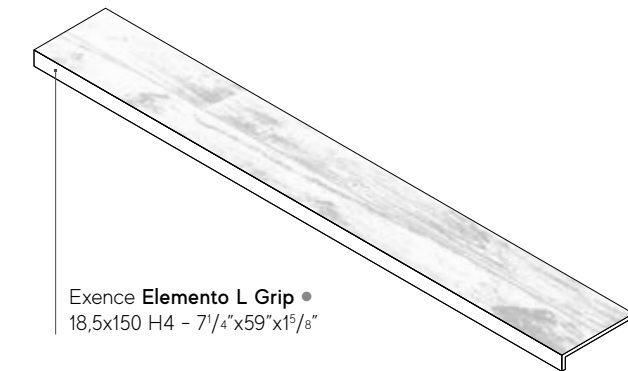

Laying tips

Sizes **18.5x150 - 7¹/₄"x59"** | **20x120 - 7⁷/₈"x47¹/₄"** cm
 Stagger the planks at a maximum of 40 cm. It's best to stagger the tiles randomly (see the illustration).

Consigli per la posa. Sfalsare i listoni di 40 cm al massimo. Si consiglia di sfalsare le piastrelle in maniera irregolare. (vedi figura).

Conseils pour la pose. Décaler les listels de 40 cm maximum. Nous conseillons de décaler les carreaux de manière irrégulière. (voir la figure).

Tipps für die Verlegung. Die Dielen maximal um 40 cm versetzt verlegen. Es empfiehlt sich, die Fliesen in unregelmäßig versetztem Verband zu verlegen (siehe Abbildung).

Recomendaciones para la instalación. Escalonar los listones un máximo de 40 cm. Se recomienda escalonar los azulejos de forma irregular (véase figura).

Рекомендации по укладке. Рекомендуется укладывать плитку со смещением не более 40 см. Кроме того, желательнo смещать плитки неравномерно (см. рисунок).

Recommended laying patten - *Schema di posa consigliato*

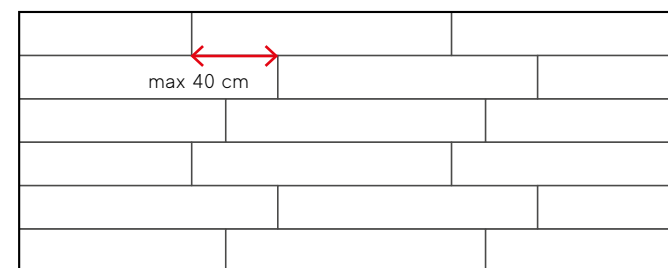

Not recommended laying patten - *Schema di posa scongiato*

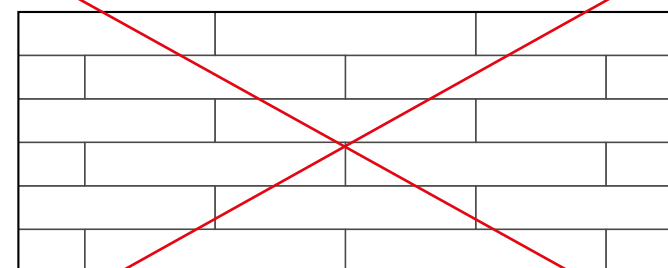

© Ceramiche Atlas Concorde

Porcelain Tiles - Rectified monocaliber

Gres porcellanato - Rettificato monocalibro

Compliant with standards EN 14411 annex G group Bla
 Compliant with standards ISO 13006 annex G group Bla
 Conforme alla norma EN 14411 Appendice G gruppo Bla
 Conforme alla norma ISO 13006 Appendice G gruppo Bla

18.5x150 cm - 7¹/₄"x59"
 20x120 cm - 7⁷/₈"x47¹/₄"
 ± 9 mm
 ± 9 mm

30x120 cm - 11¹/₄"x47¹/₄"
 ± 20 mm



Technical features Caratteristiche tecniche	Test Method Metodo di prova	Requirements for nominal size N / Requisiti per dimensione nominale N			Porcelain tiles		
		7 cm ≤ N < 15 cm (mm)	N ≥ 15 cm (%)	(mm)	Matte Sensitech ± 9 mm	Grip ± 9 mm	Outdoor ± 20 mm
Length and width Lunghezza e larghezza Thickness Spessore Straightness of sides Rettilineità degli spigoli Rectangularity (Measurement only on short edges when L/l ≥ 3) Ortogonalità (Misurazione da condurre solo sui lati corti quando L/l ≥ 3)	ISO 10545-2	± 0.9 (*) Non-rect. ± 0.4 (*) Rect.	± 0.6 (*) Non-rect. ± 0.3 (*) Rect.	± 2.0 (*) Non-rect. ± 1.0 (*) Rect.	Suitable for Conformance	Suitable for Conformance	Suitable for Conformance
		± 0.5 (**)	± 5 (**)	± 0.5 (**)	Suitable for Conformance	Suitable for Conformance	Suitable for Conformance
		± 0.8 (***) Non-rect. ± 0.4 (***) Rect.	± 0.5 (***) Non-rect. ± 0.3 (***) Rect.	± 1.5 (***) Non-rect. ± 0.8 (***) Rect.	Suitable for Conformance	Suitable for Conformance	Suitable for Conformance
Surface flatness Planarità	ISO 10545-2	c.c. ± 0.8 Non-rect. c.c. ± 0.6 Rect.	c.c. ± 0.5 Non-rect. c.c. ± 0.4 Rect.	c.c. ± 2.0 Non-rect. c.c. ± 1.8 Rect.	Suitable for Conformance	Suitable for Conformance	Not applicable to "strong" structures Non applicabile a strutturati forti
		e.c. ± 0.8 Non-rect. e.c. ± 0.6 Rect.	e.c. ± 0.5 Non-rect. e.c. ± 0.4 Rect.	e.c. ± 2.0 Non-rect. e.c. ± 1.8 Rect.			
		w. ± 0.8 Non-rect. w. ± 0.6 Rect.	w. ± 0.5 Non-rect. w. ± 0.4 Rect.	w. ± 2.0 Non-rect. w. ± 1.8 Rect.			
Water absorption (in % by mass) Massa d'acqua assorbita (come % della massa)	ISO 10545-3	E _v ≤ 0.5% Individual Maximum 0.6% E _v ≤ 0.5% Valore massimo singolo 0.6%			≤ 0.1%	≤ 0.1%	≤ 0.1%
	ASTM C373	Requirement ANSI A137.1 Water absorption max ≤ 0.5%			≤ 0.5%	≤ 0.5%	≤ 0.5%
Breaking strength Sforzo di rottura Modulus of rupture Resistenza alla flessione	ISO 10545-4	S ≥ 700N (for thickness < 7.5 mm - per spessore < 7.5 mm) S ≥ 1300N (for thickness ≥ 7.5 mm - per spessore ≥ 7.5 mm)			S ≥ 1500 N	S ≥ 1500 N	S ≥ 10000 N
		R ≥ 35 N/mm ²			R ≥ 40 N/mm ²	R ≥ 40 N/mm ²	R ≥ 45 N/mm ²
Bending strength and breaking load Resistenza a flessione e al carico di rottura (4)(5)	EN 1339 Annex F	-			-	-	≥ U3 30x120
Impact resistance, as coefficient of restitution Resistenza all'impatto, espresso come coefficiente di restituzione	ISO 10545-5	Declared value Valore dichiarato			≥ 0.55	≥ 0.55	≥ 0.55
Resistance to deep abrasion of unglazed tiles (removed volume) Resistenza all'abrasione profonda delle piastrelle non smaltate (volume materiale asportato)	ISO 10545-6	≤ 175 mm ³			≤ 150 mm ³	≤ 150 mm ³	≤ 150 mm ³
Coefficient of thermal linear expansion Coefficiente di dilatazione termica lineare	ISO 10545-8	Declared value Valore dichiarato			≤ 7 MK ⁻¹	≤ 7 MK ⁻¹	≤ 7 MK ⁻¹
Thermal shock resistance Resistenza agli sbalzi termici	ISO 10545-9	Pass according to EN ISO 10545-1 Test superato in accordo con ISO 10545-1			Resistant Resiste	Resistant Resiste	Resistant Resiste
Moisture expansion (in mm/m) Dilatazione all'umidità (in mm/m)	ISO 10545-10	Declared value Valore dichiarato			≤ 0.01% (0,1mm/m)	≤ 0.01% (0,1mm/m)	≤ 0.01% (0,1mm/m)
Frost resistance Resistenza al gelo	ISO 10545-12	Pass according to EN ISO 10545-1 Test superato in accordo con ISO 10545-1			Resistant Resiste	Resistant Resiste	Resistant Resiste
Bond strength/adhesion for improved cementitious adhesives Adesione a trazione con adesivi cementizi migliorati	EN 1348	Declared value Valore dichiarato			≥ 1.0 N/mm ² (Class C2 - EN 12004)	≥ 1.0 N/mm ² (Class C2 - EN 12004)	≥ 1.0 N/mm ² (Class C2 - EN 12004)
Reaction to fire Reazione al fuoco	-	Class A1 or A1 _f Classe A1 oppure A1 _f			A1 - A1 _f	A1 - A1 _f	A1 - A1 _f
Resistance to household chemicals and swimming pool salts Resistenza ai prodotti chimici di uso domestico e agli additivi per piscina Resistance to low concentrations of acids and alkalis Resistenza a basse concentrazioni di acidi e alcali Resistance to high concentrations of acids and alkalis Resistenza ad alte concentrazioni di acidi e alcali	ISO 10545-13	Minimum Class B Classe minima B			A	A	A
		Declared Class Classe dichiarata			LA	LA	LA
		Declared Class Classe dichiarata			HA	HA	HA
Resistance to staining, for unglazed tiles Resistenza alle macchie per piastrelle non smaltate	ISO 10545-14	Declared Class Classe dichiarata			5	5	5
Shod Ramp Test Metodo della rampa "calzato"	DIN EN 16165 ANNEX B (EX DIN 51130)	Declared value Valore dichiarato			R10	R11	R11
Barefoot Ramp Test Metodo della rampa a piedi nudi	DIN EN 16165 ANNEX A (EX DIN 51097)	Declared value Valore dichiarato			A+B	A+B+C	A+B+C
Pendulum Friction Test Metodo del Pendolo	EN 16165 ANNEX C (EX BS 7976)	PTV ≥ 36 classifies the surface as "low slip risk"			≥ 36 Dry ≥ 36 Wet	≥ 36 Dry ≥ 36 Wet	≥ 36 Dry ≥ 36 Wet
	AS 4586	Declared Classification of the new pedestrian surface materials according to the Pendulum Test			Class P3	Class P4	Class P4
	UNE 41901 EX:2017	Declared value Valore dichiarato			Class C2	Class C3	Class C3
Coefficient of friction (COF) Coefficiente di attrito	B.C.R.A. Rep. CEC/81	D. M. 236/89 del 14/06/89 μ > 0.40 per elemento scivolante cuoio su pavimentazione asciutta μ > 0.40 per elemento scivolante gomma dura su pavimentazione bagnata			> 0.40 Asciutto > 0.40 Bagnato	> 0.40 Asciutto > 0.40 Bagnato	> 0.40 Asciutto > 0.40 Bagnato
Dynamic coefficient of friction (DCOF) Coefficiente di attrito dinamico	ANSI A 326.3	-			wet DCOF ≥ 0.50	wet DCOF ≥ 0.55	wet DCOF ≥ 0.55

(*) The permissible deviation, in % or mm, of the average size for each tile (2 or 4 sides) from work size (WS).
 (**) The permissible deviation, in % or mm, of the average thickness for each tile from the work size thickness (WS).
 (***) The maximum permissible deviation from straightness, in % or mm, related to the corresponding work sizes (WS).
 (****) The maximum permissible deviation from rectangularity, in % or mm, related to the corresponding work sizes (WS).
 (c.c.) The maximum permissible deviation from centre curvature, in % or mm, related to diagonal calculated from the work sizes (WS).
 (e.c.) The maximum permissible deviation from edge curvature, in % or mm, related to the corresponding work sizes (WS).
 (w.) The maximum permissible deviation from warpage, in % or mm, related to diagonal calculated from the work sizes (WS).
 (1) Determination of slip resistance of pedestrian surfaces; it does not cover sports surfaces and road surfaces for vehicles (skid resistance).
 (2) Anti-slip performance is guaranteed at the time of delivery of the product.
 (4) For further details, please refer to outdoor design general catalogue.
 (5) Only for products with 20 mm thickness.





We care

- 58 PORCELAIN TILES: A SAFE CHOICE
- 60 ENVIRONMENTAL SUSTAINABILITY
- 62 ETHICAL IDENTITY



Wood look porcelain tiles: a safe choice.

DISCOVER
MORE
EN | IT | FR | DE | ES | RU

UV RESISTANT
Resistente ai raggi UV

IDEAL FOR FLOOR HEATING SYSTEMS
Ideale per riscaldamenti a pavimento

WATERPROOF AND FROST RESISTANT
Resistente agli shock termici e all'acqua

NO OILS, WAXES OR PRIMERS
No olii, cere o impregnanti

STAIN RESISTANT
Resistente alle macchie

EASY TO CLEAN AND DISINFECT
Facile da pulire e sanificare

ECO-FRIENDLY
Ama l'ambiente

HYGIENIC
Igienico

FIREPROOF
Non brucia

PREVENT BACTERIAL GROWTH
Previene la crescita batterica

FREE FROM TOXIC AND POLLUTING ELEMENTS (ZERO VOCS)
Privo di elementi tossici e inquinanti (zero VOCs)



page 46

Environmental sustainability.



CERTIFICATIONS

Company / Azienda



Product / Prodotto



Product "Declarations" / Dichiarazioni di prodotto



An ecological transition is among the company's industrial priorities. Our plants comply with the most stringent international regulations – fully automated and low-impact – as they are equipped with energy cogeneration systems. A constant commitment to the total reduction of waste and emissions completes the picture of a company oriented towards maximum environmental sustainability.

La transizione ecologica è tra le priorità industriali dell'azienda. I nostri impianti sono conformi alle più stringenti normative internazionali, completamente automatizzati e a basso impatto, in quanto dotati di sistemi di cogenerazione energetica. Il costante impegno per la totale riduzione degli sprechi e delle emissioni completano il quadro di un'azienda orientata alla massima sostenibilità ambientale.

La transition écologique est une des priorités industrielles de l'entreprise. Nos installations sont conformes aux réglementations internationales les plus sévères, entièrement automatisées et à faible impact, car équipées de systèmes de cogénération énergétique. L'engagement constant pour la réduction totale du gaspillage et des émissions complète le tableau d'une entreprise engagée pour une meilleure durabilité environnementale.

Der ökologische Wandel gehört zu den Prioritäten der industriellen Strategie des Unternehmens. Unsere Anlagen entsprechen den strengsten internationalen Richtlinien; sie arbeiten vollautomatisch und umweltschonend, denn sie sind mit Kraft-Wärme-Kopplungssystemen ausgerüstet. Ein weiterer Aspekt dieses Unternehmens, das sich ganz der Erreichung maximaler ökologischer Nachhaltigkeit verschrieben hat, ist sein kontinuierliches Engagement für die völlige Eliminierung von Verschwendung und Emissionen.

La transición ecológica está entre las prioridades industriales de la empresa. Nuestras plantas cumplen las normas internacionales más estrictas, totalmente automatizadas y de bajo impacto, ya que están equipadas con sistemas de cogeneración energética. Los esfuerzos constantes por reducir completamente los residuos y las emisiones completan la imagen de una empresa centrada en la máxima sostenibilidad medioambiental.

Экологический переход – один из основных технологических приоритетов компании. Наши производственные процессы отвечают требованиям строжайших международных стандартов, автоматизированы, оказывают минимальное воздействие на окружающую среду, а кроме того, на заводе работает собственная когенерационная установка. А еще мы принимаем меры по сокращению отходов и выбросов, что является еще одним свидетельством ориентации на экологическую устойчивость.



© Ceramiche Atlas Concorde

OVERVIEW



IMAGE GALLERY



SURFACE RANGE & TECHNICAL SPECS.



WE CARE



PORCELAIN TILES: A SAFE CHOICE

ENVIRONMENTAL SUSTAINABILITY

ETHICAL IDENTITY

Ethical identity.



For Atlas Concorde, being Made in Italy is not just a prestigious certification of style, design, and production excellence, but an identity that involves all aspects of its business. For this reason, we identify with the values expressed by Confindustria Ceramica's ethical code, which guarantee absolute compliance with labor regulations, and with the marks Made in Italy and Ceramics of Italy, which certify the quality of authentic Italian style.

Pour Atlas Concorde, le Made in Italy n'est pas seulement une prestigieuse attestation de style, de design et d'excellence de la production, mais une manière d'être qui prend en compte tous les aspects de notre activité. C'est pourquoi nous nous reconnaissons d'abord dans les valeurs exprimées dans le code éthique de Confindustria Ceramica qui garantissent le respect absolu des réglementations sur le travail, mais aussi dans les labels Made in Italy et Ceramics of Italy qui certifient la qualité du vrai style italien.

Para Atlas Concorde, Made in Italy no es sólo un prestigioso certificado de excelencia en estilo, diseño y fabricación, sino una forma de ser que abarca todos los aspectos de su actividad. Por eso nos identificamos con los valores expresados en el código ético de Confindustria Ceramica, que garantizan el respeto absoluto de la normativa laboral, y de las marcas Made in Italy y Ceramics of Italy, que certifican la calidad del auténtico estilo italiano.

Per Atlas Concorde, Made in Italy non è solo un prestigioso attestato di stile, design ed eccellenza produttiva, ma un modo di essere che coinvolge tutti gli aspetti della propria attività. Per questo ci riconosciamo nei valori espressi dal codice etico di Confindustria Ceramica, che garantiscono il rispetto assoluto delle normative sul lavoro, e nei marchi Made in Italy e Ceramics of Italy, che certificano la qualità dell'autentico stile italiano.

Für Atlas Concorde ist das Made in Italy mehr als nur ein prestigievolles Gütezeichen für Stil, Design und exzellente Produktion. Es ist eine Einstellung, die alle Aspekte der Tätigkeit einbezieht. Wir teilen die im Ethikcode des Unternehmerverbands Confindustria Ceramica zum Ausdruck kommenden Werte, welche die strenge Einhaltung der arbeitsrechtlichen Vorschriften garantieren, sowie jene der Gütesiegel Made in Italy und Ceramics of Italy als Garantie von Qualität in authentischem, italienischem Stil.

«Made in Italy» для Atlas Concorde не просто знак подтверждения стиля и качественного производства, а образ жизни, который включает в себя все аспекты деятельности. Поэтому мы полностью разделяем ценности, закрепленные в «Этическом кодексе» федерации Confindustria Ceramica (ассоциация предприятий керамической отрасли) и предусматривающие строгое соблюдение трудового законодательства. А маркировка Made in Italy и Ceramics of Italy на нашей плитке является гарантией ее качества и аутентичного итальянского дизайна.



© Ceramiche Atlas Concorde

OVERVIEW >

IMAGE GALLERY >

SURFACE RANGE & TECHNICAL SPECS. >

WE CARE >

PORCELAIN TILES: A SAFE CHOICE

ENVIRONMENTAL SUSTAINABILITY

ETHICAL IDENTITY



Ceramiche Atlas Concorde S.p.A.
Via Canaletto 141
41042 Spezzano di Fiorano (MO) – Italia

Atlas Concorde USA, Inc.
117 Seaboard Lane – Suite F170
Franklin, TN 37067 – USA

Atlas Concorde Russia
Business centre “Meliora Place”
Prospekt Mira 6
129090 Moscow – Russia

Atlas Concorde Middle East, Fz-Llc
Building 8 – Suite 106
D3 Dubai Design District
United Arab Emirates

atlasconcorde.com

Copyright 2023 by Ceramiche Atlas Concorde S.p.A
(41042 Spezzano di Fiorano (MO) – Italia)
March 2023